



# Mendeleev 2024

XIII International Conference on Chemistry  
for Young Scientists

# BOOK OF ABSTRACTS



St Petersburg  
University

# **BOOK OF ABSTRACTS**

**XIII International Conference on Chemistry  
for Young Scientists “MENDELEEV 2024”**

St Petersburg, Russia  
September 2-6,  
2024

XIII International Conference on Chemistry for Young Scientists “MENDELEEV 2024”.  
St Petersburg. September 2–6, 2024. Book of abstracts.— St Petersburg.: VVM  
Publishing LLC, 2024.— 822 p.

ISBN 978-5-9651-1584-6

Book of abstracts contains theses of plenary, keynote, oral and poster presentations  
which were presented on **Mendeleev 2024**, the XIII International Conference on  
Chemistry for Young Scientists. The Mendeleev 2024 Conference hold in Saint  
Petersburg (September 2–6, 2024).

Abstracts are presented in the author's edition with minimal technical corrections.

## DEDICATED TO

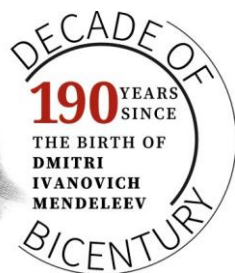
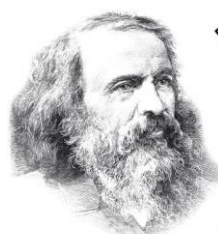

@mendeleev.spbu



@Mendeleev\_spbu

© Authors, 2024  
© VVM Publishing LLC, 2024



## PROGRAM COMMITTEE

### *CHAIR:*

Dr. Sci., Prof. **Irina Balova**, Director of the Institute of Chemistry, St. Petersburg State University

### VICE CHAIRS:

Dr., Assoc. Prof. **Mariia Dmitrenko**, St. Petersburg State University

Dr. Sci., Assoc. Prof. **Mikhail Kinzhalov**, St. Petersburg State University

### ORGANISING COMMITTEE:

Dr. Sci., Prof. **Alina Manshina**

Dr. Sci., Prof. **Andrey Bulatov**

Dr., Assoc. Prof. **Nikita Bogachev**

Dr., Assoc. Prof. **Maria Vetrova**

Dr. **Anna Vasileva**

Dr. **Yulia Toikka**

**Valerii Verkhov**

Dr., Assoc. Prof. **Vladimir Mikhaylov**

Dr. **Anastasiia Podurets**

Dr. **Sergey Baykov**

Dr. **Maria Ledovskaya**

**Ilia Filippov**

**Mia Kim**

**Andrei Karcheuski**

**Pavel Yakupov**

**Danil Krutin**

Dr. Sci., Prof. **Anastasia Penkova**

Dr., Assoc. Prof. **Olga Bakulina**

Dr., Assoc. Prof. **Elena Tupikina**

Dr., Prof. **Irina Timofeeva**

Dr. **Anna Kuzminova**

**Polina Paramonova**

**Egor Manzhosov**

Dr. Sci., Assoc. Prof. **Nikolai Rostovskii**

Dr., Assoc. Prof. **Mariia Efremova**

Dr., Assoc. Prof. **Artemiy Samarov**

Dr. **Svetlana Baykova**

**Georgii Misikov**

**Troyana Kissler**

**Liya Arkaniya**

**Elina Alikparova**

**Mark Kaplanskiy**

## GENERAL SPONSOR



## SPONSORS



## INFOPARTNERS





# CONTENTS

<b>PROGRAM COMMITTEE .....</b>	<b>3</b>
<b>SPONSORS .....</b>	<b>4</b>
<b>PLENARY SPEAKERS .....</b>	<b>8</b>
<b>ADVANCED MATERIALS AND TECHNOLOGIES.....</b>	<b>19</b>
<b>MODERN TRENDS IN POLYMER SCIENCE .....</b>	<b>166</b>
<b>NEW TECHNOLOGIES AND MATERIALS FOR CHEMICAL ANALYSIS .....</b>	<b>280</b>
<b>ORGANIC, ORGANOMETALLIC AND MEDICINAL CHEMISTRY .....</b>	<b>388</b>
<b>ADVANCES IN COORDINATION AND INORGANIC CHEMISTRY .....</b>	<b>601</b>
<b>THEORETICAL CHEMISTRY .....</b>	<b>719</b>
<b>ECONOMICS OF THE CHEMICAL INDUSTRY IN THE CONTEXT OF MODERN CHALLENGES .....</b>	<b>802</b>



## ЭЛЕМЕНТНЫЙ И ИЗОТОПНЫЙ АНАЛИЗ

(ИСП-АЭС, ИСП-МС, РФА, ТИМС,  
 Пламенные фотометры)

## ГАЗОАДСОРБЦИОННОЕ ОБОРУДОВАНИЕ

(Анализаторы удельной поверхности и размеров пор,  
 Анализаторы хемосорбции, Гелиевые пикнометры)

## МОЛЕКУЛЯРНЫЙ АНАЛИЗ

(ИК-Фурье, Раман, УФ-вид, КД)

## ПРОБОПОДГОТОВКА

(Системы очистки воды и кислот, Измельчение, Прессование,  
 Микроволновое разложение, Кислотное разложение и др.)

ХИМИЧЕСКАЯ  
 ПРОМЫШЛЕННОСТЬ



АТОМНАЯ  
 ПРОМЫШЛЕННОСТЬ



НЕФТЕХИМИЯ И  
 НЕФТЕПЕРЕРАБОТКА



ГЕОЛОГИЯ И  
 ГЕОХИМИЯ



МЕТАЛЛУРГИЯ



КРИМИНАЛИСТИКА



АНАЛИЗ ВАШИХ ОБРАЗЦОВ В СОБСТВЕННОЙ ДЕМОНСТРАЦИОННОЙ ЛАБОРАТОРИИ ЛАБТЕСТ

ПОСТАВКА  
 ОБОРУДОВАНИЯ

ПОДБОР  
 КОМПЛЕКТУЮЩИХ

МЕТОДИЧЕСКАЯ  
 ПОДДЕРЖКА

ТЕХНИЧЕСКОЕ  
 ОБСЛУЖИВАНИЕ

# COLAB.WS

CoLab — a platform that provides **convenient** access to information about the activities of **researchers** and **labs** for collaboration from around the world

**5100+**  
researchers

**5700+**  
organizations

**450+**  
laboratories

**700+**  
conferences

- ✓ Personal **recommendation** system
- ✓ **Publication** activity and **citation** statistics for each scientific organization and each user
- ✓ **Cobalt** — search engine based on a proprietary metadata database of 118 million publications and 1.6 billion citations

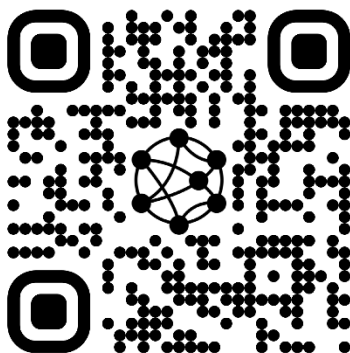

✉ [info@colab.ws](mailto:info@colab.ws)





# **PLENARY SREAKERS**



### **Dr.Sci., Prof. Yulia Gorbunova**

*Academician of the Russian Academy of Sciences (RAS),  
Vice-President of the Mendeleev Russian Chemical Society,  
Dean of the Faculty of Lomonosov Moscow State University,  
Head of the Group, Kurnakov Institute of General and Inorganic  
Chemistry of the RAS, Moscow, Russia*

#### **The Molecular Basis of Tetrapyrrole Action as Nanophototheranostic Agents**

### **Dr.Sci., Prof. Alexander Terent'ev**

*Corresponding Member of the Russian Academy of Sciences,  
Director, N. D. Zelinsky Institute of Organic Chemistry  
Russian Academy of Sciences, Moscow, Russia*

#### **The Wonderful World of Organic Peroxides**



### **Dr., Prof. Ping Xu**

*Vice Dean, School of Chemistry and Chemical Engineering,  
Harbin Institute of Technology, Harbin, China*

#### **Magnetic Field-Assisted Electrocatalysis**

### **Dr., Prof. Rongxin Su**

*Vice Dean, School of Chemical Engineering and Technology,  
Tianjin University, Tianjin, China*

#### **Green Production and Application of Nanocellulose**





**Dr., Prof. Daniel Pasquini**

*Universidade Federal de Uberlândia, Uberlândia, Brazil*

**Lignocellulosic Biomass as a Source to Produce Biofuels, Chemicals, and Polymers, in the Context of Biorefinery**

**Dr. Sci., Prof. Sergei Shtykov**

*Honored Scientist of the Russian Federation, Saratov State University, Saratov, Russia*

**Nanoanalytics – a Reply of Analytical Chemistry to the Era of Nanotechnology**



**Dr. Sci., Prof. Artem Oganov**

*Professor of the Russian Academy of Sciences, Skolkovo Institute of Science and Technology, Moscow, Russia*

**Structure and Composition of Crystals and Molecules: Novel Phenomena and Their Explanation**

**Dr. Sci., Prof. Olga Korableva**

*Member of the International Association Enterprise Architecture/Open Group, Entrepreneurship and Innovation, St. Petersburg State University, St. Petersburg, Russia*

**Science-Intensive Economy and Systemic Technological Transformation in the Modern Development of the Chemical Industry**



THE MOLECULAR BASIS OF TETRAPYRROLE ACTION  
AS NANOPHOTOTHERANOSTIC AGENTS

Gorbunova Yu.G.<sup>1</sup>

<sup>1</sup> Kurnakov Institute of General and Inorganic Chemistry of the Russian Academy of Sciences,  
Moscow, Russia  
*Academician of the Russian Academy of Sciences (RAS), Vice-President of the Mendeleev Russian  
Chemical Society, Dean of the Faculty of Lomonosov Moscow State University, Head of the Group,  
Dr.Sci., Professor*  
[yulia.gorbunova@gmail.com](mailto:yulia.gorbunova@gmail.com)

THE WONDERFUL WORLD OF ORGANIC PEROXIDES

*Terent'ev A.O.*<sup>1</sup>

<sup>1</sup> N.D. Zelinsky Institute of Organic Chemistry Russian Academy of Sciences, Moscow, Russia  
*Dr.Sci., Professor, Corresponding Member of the Russian Academy of Sciences, Director*  
[terentev@ioc.ac.ru](mailto:terentev@ioc.ac.ru)

Organic peroxides were previously considered as unstable compounds and were used mainly to initiate radical processes. Later it turned out that a number of fairly stable peroxides are widespread in nature. Currently, peroxides are widely used in industry to produce polymers, and peroxides are also active substances in a number of drugs. In our works we found a new field of chemistry of stable organic peroxides and disclosed their beneficial properties.

## MAGNETIC FIELD-ASSISTED ELECTROCATALYSIS

Ping Xu

School of Chemistry and Chemical Engineering  
Harbin Institute of Technology, Harbin, China  
Dr., Professor, Vice Dean, School of Chemistry and Chemical Engineering  
[pxu@hit.edu.cn](mailto:pxu@hit.edu.cn)

Magnetic field-enhanced electrocatalysis has recently emerged as an advanced strategy with great application prospects for highly efficient energy conversion and storage. Directly or indirectly, the magnetic effect has been proved positive in various electrochemical reactions. This talk starts from a brief introduction and analysis to the possible mechanisms of magnetic field-enhanced electrocatalysis. The recent advances in magnetic field-enhanced electrochemical reactions<sup>[1,2]</sup>, including hydrogen evolution reaction (HER), oxygen evolution reaction (OER), oxygen reduction reaction (ORR), and CO<sub>2</sub> reduction reaction (CO<sub>2</sub>RR), will be covered. Examples include our own studies on OER behaviors of nickel-based catalysts (Ni(OH)<sub>2</sub>, NiO, and Ni)<sup>[3]</sup> and NiFe-LDH/Co<sub>3</sub>O<sub>4</sub> p-n heterojunction supported on nickel foam<sup>[4]</sup> under an in situ applied magnetic field, by using a self-designed electrochemical system coupled with a vibrating sample magnetometer that can fine-tune the intensity of the magnetic field (0–1.4 T).

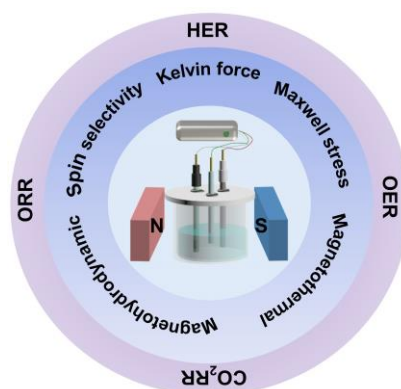

**Scheme 1.** Possible mechanisms (magnetothermal effect, magnetohydrodynamic effect, Maxwell stress effect, Kelvin force effect, and spin selectivity effect) of magnetic field-enhanced electrocatalysis.

## References

- [1] Yuanyuan Zhang, Ce Liang, Jie Wu, Han Liu, Bin Zhang, Zaixing Jiang, Siwei Li,\* Ping Xu\*. Recent Advances in Magnetic Field-Enhanced Electrocatalysis. *ACS Appl. Energy Mater.* **2020**, 3, 10303-10316.
- [2] Yuanyuan Zhang, Qiang Fu, Bo Song\*, Ping Xu\*. Regulation Strategy of Transition Metal Oxide-Based Electrocatalysts for Enhanced Oxygen Evolution Reaction. *Acc. Mater. Res.* **2022**, 3(10), 1088-1100.
- [3] Yuanyuan Zhang, Ping Guo, Siwei Li, Wei Wang, Bo Song, Xiaoxuan Yang, Xianjie Wang, Zaixing Jiang, Gang Wu\*, Ping Xu\*. Magnetic Field Assisted Electrocatalytic Oxygen Evolution Reaction of Nickel-Based Materials. *J. Mater. Chem. A* **2022**, 10, 1760-1767.
- [4] Yuanyuan Zhang, Ping Guo, Siqi Niu, Jie Wu, Wei Wang, Bo Song, Xianjie Wang, Zaixing Jiang, Ping Xu\*. Magnetic Field Enhanced Electrocatalytic Oxygen Evolution of NiFe-LDH/Co<sub>3</sub>O<sub>4</sub> p-n Heterojunction Supported on Nickel Foam. *Small Methods* **2022**, 6, 2200084.

## Acknowledgements

This work was supported by the National Natural Science Foundation of China (project No 22071038).

## GREEN PRODUCTION AND APPLICATION OF NANOCELLULOSE

*Su R., Zhang L., Chen S.H., Shan C.C., Che M.D., Ai Y.S., Qiao A.H.*

Tianjin University, Tianjin, China

*Dr., Professor , Vice Dean, School of Chemical Engineering and Technology*

[surx@tju.edu.cn](mailto:surx@tju.edu.cn)

Nanocellulose including cellulose nanocrystals (CNC) and cellulose nanofibrils (CNF) has become a hotspot in the field of green and sustainable materials. Several improvements have been developed for the cleaner and large-scale production of the nanocellulose industry. The processes for the fabrication of sulfonated CNC [1-3], phosphorylated CNC [4], carboxylic CNF [5], phosphorylated CNF [6] have been optimized in our lab with lower environmental impact. The application of cellulose nanocrystals and cellulose nanofibrils on antifouling coating [7-8], algae control [9], wastewater treatment [10-12], edible food coating, flexible sensors [13-15], light management in our lab will be introduced.

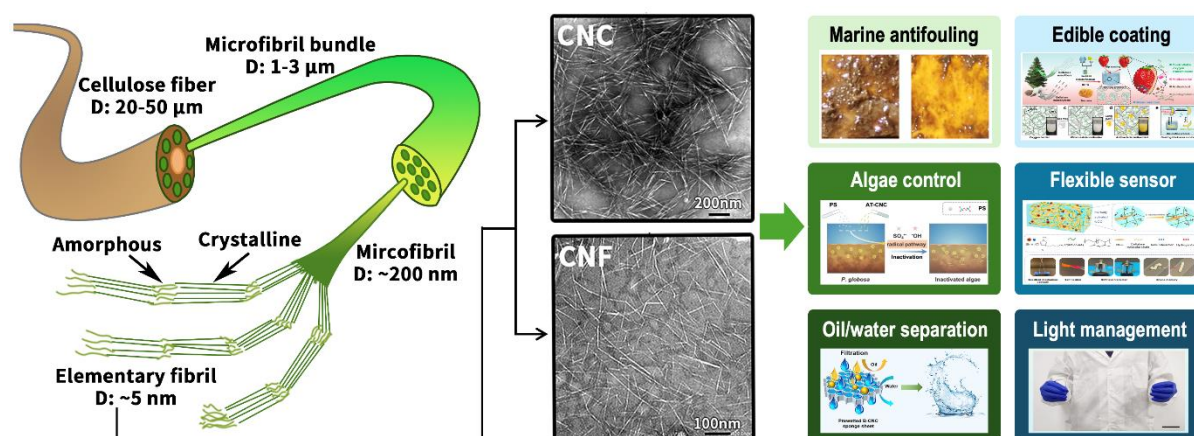

**Scheme 1.** Production and application of cellulose nanocrystals and nanofibrils.

## References

- [1] *AIChE Journal* **2023**, 69, e18186
- [2] *ACS Sustainable Chemistry & Engineering* **2022**, 10, 13266–13276
- [3] *Journal of Cleaner Production*, **2022**, 345, 131073
- [4] *Green Chemistry* **2023**, 25, 5041-5050
- [5] *Carbohydrate Polymers* **2022**, 294, 119803
- [6] *ACS Sustainable Chemistry & Engineering* **2022**, 10, 8876-8884
- [7] *Carbohydrate Polymers* **2023**, 304, 120504
- [8] *Langmuir* **2023**, 39, 7212-7220.
- [9] *Chemosphere* **2023**, 313, 137647
- [10] *Water Research* **2023**, 243, 120420
- [11] *Carbohydrate Polymers* **2023**, 312, 120807
- [12] *Separation and Purification Technology* **2022**, 295, 121266
- [13] *Cell Reports Physical Science* **2023**, 4, 101511.
- [14] *Chemical Engineering Journal* **2022**, 450, 138256
- [15] *Carbohydrate Polymers* **2023**, 320, 121211

LIGNOCELLULOSIC BIOMASS AS A SOURCE TO PRODUCE BIOFUELS, CHEMICALS, AND POLYMERS, IN THE CONTEXT OF BIOREFINERY

*Pasquini D.*

Federal University of Uberlândia, Uberlândia, Brazil

Dr., Professor

[daniel.pasquini@ufu.br](mailto:daniel.pasquini@ufu.br)

The simplistic definition of biorefineries is that they are industrial plants where multiple products are obtained from one raw material, the biomass. This concept was created using an analogy to oil refineries, where multiple products are produced from oil as the main raw material. The main difference between oil refinery and biorefinery, is that in the latter case, the derivative products are from a renewable source and as consequence reduce the carbon emissions balance considering their life cycle. In the case of biorefineries, the raw materials come from biomass of animal or vegetal origin. Considering the vegetal source, the lignocellulosic biomass stands out as a raw material for these biorefineries, as they are already used in several established industrial processes, whose processes can generate by-products that are still little explored for new applications and that have the potential for producing new added value products [1-2]. Taking as example the current uses of lignocellulosic biomass in Brazil, like Eucalyptus in the cellulose industries and, also, in biofuel industries such as ethanol (from sugarcane) and biodiesel (from soy), in which there are a generation of lignocellulosic waste that can be used to produce both biofuels and chemical derivatives and, also, polymeric materials, many other products can be produced in order to minimize environmental impacts and add value to the production chain. These residues contain a large amount of high molecular weight carbohydrates (cellulose and hemicelluloses), and lignin, which can be used for applications directly in polymeric form and in the preparation of polymeric derivatives. However, these similar molecules can be fragmented into monomeric units for use in new stages of synthesizing products of commercial interest. An example of this is the use of pentoses and hexoses to produce ethanol (cellulosic or second-generation ethanol) or as precursors of furanic derivatives, such as furfural and 5-hydroxymethylfurfural (5-HMF), which serve as starting molecules for the properties of several other molecules of interest in various sectors [3]. Figure 1 shows some examples of molecules that can be produced from furfural and 5-HMF.

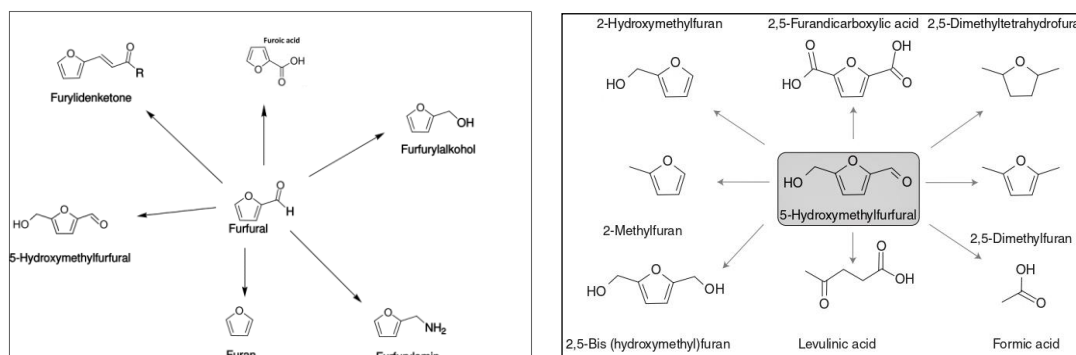

**Figure 1.** Furfural and 5-HMF chemical platform examples.

Considering the examples mentioned, and many others that are already highlighted in syntheses of compounds from biomass, many companies, such as those mentioned previously, have the potential to expand and diversify products in their production chains, implementing the concept of biorefinery and making rational use of biomass to add value to the production chain and contribute to reducing environmental impacts.

### References

- [1] *Catalysts* **2021**, 11, 309
- [2] *Bioresour. Technol.* **2022**, 344, 126241
- [3] *Handbook of Biomass* **2024**, chapter 5, 105

### Acknowledgements

The author would like to thank Brazilian National Council for Scientific and Technological Development (CNPq), Brazil, grant number 440057/2022-1, for the financial support.



## NANOANALYTICS – A REPLY OF ANALYTICAL CHEMISTRY TO THE ERA OF NANOTECHNOLOGY

*Shtykov S.N.*

Saratov State University, Saratov, Russia  
*Dr.Sci., Professor, Honored Scientist of the Russian Federation*  
[shtykovsn@mail.ru](mailto:shtykovsn@mail.ru)

Nanotechnology is now the most popular and fastest growing interdisciplinary field of science. Analytical chemistry, being also interdisciplinary in nature, cannot ignore the attractive force and achievements of nanotechnology. As a result, the term "nanoanalytics" emerged, but it currently has different meanings due to the lack of consensus in the analytical community on the issue. Some analysts believe that the concept of "nanoanalytics" is artificial, a tribute to fashion, and can be dispensed with. It is proposed to call this section, for example, nanoanalytical chemistry or not to introduce the term with the prefix "nano" at all, since they believe that nothing new has appeared in the analysis. We cannot agree with this, since the emergence of nanoobjects and nanotechnologies has led to the use in analytical chemistry of new effects, principles, approaches, new variants of known methods, and the study of new types of patterns necessary for the development of the theory and practice of chemical analysis. These approaches and options are based on physical phenomena and processes that are quite new for analysis, which began to be studied in the last decade of the last century and are actively used only in the 21st century. Examples of such phenomena include surface plasmon resonance (SPR), surface-enhanced (giant) Raman scattering (SERS), superparamagnetism, and fluorescence of quantum dots — particles of substances of the most diverse nature that do not emit light in micro- or macroscale. The basis of such phenomena is quantum-sized effects. These technologies and phenomena need to be studied, they need to be learned to be controlled, and this is important for the study of nanoanalytics as a part of analytical chemistry at universities.

The fascination with quantum-sized effects in the 21st century has led to the fact that another type of nanosystems has disappeared from the attention of researchers - the world of liquid nanoobjects, such as micelles, microemulsions, enzymes, liposome's, vesicles and receptor molecules with an internal three-dimensional cavity. Their functions are determined by supramolecular and local effects, which make it possible to change the properties of the medium in the microenvironment of the components of the analytical reaction, the solvation, the distance between particles, and the effects of energy and charge transfer. Such nanosystems have no macroscopic analogues; they are thermodynamically stable and can exist only in a nanosized state, and the law of mass action is applicable to them.

A careful study of publications allows us to propose the following definition of nanoanalytics. "Nanoanalytics is a field of analytical chemistry that develops the principles and methods of applying nanotechnologies, and the specific properties of nanosized objects in chemical analysis" [1, 2]. According to this definition, we can identify and understand what the problems are and how to solve them by looking at the concept, elements and features of nanoanalytics. There is no doubt that nanoanalytics deals with various nanotechnologies, which, in turn, can be divided into two groups. The first includes physical measurement technologies that are used to characterize the size, morphology and chemical composition of nanoobjects. The second group includes chemical-synthetic technologies for creating new nanoobjects in order to obtain new analytical capabilities. Nanoobjects serve as tools for chemical analysis and can also be divided into two groups: solid and liquid nanoobjects, which differ from a thermodynamic point of view. The third task of nanoanalytics includes the analysis of nanoobjects themselves, both for their characterization and determination in various objects. The problem of reference materials of nanoobjects and metrology of nanoanalytics is closely related to it [3]. Some detailed information regarding this concept and the applications of nanotechnology, solid and liquid nanoobjects, and the chemical analysis of the nanoobjects themselves will be presented and discussed.

**References**

- [1] Nanoanalytics, S. Shtykov (Ed.), De Gruyter, Berlin, **2018**, 3
- [2] Analytical Chemistry. Vol. 3, A.A. Ischenko (Ed.). FIZMATLIT, Moscow, **2020**, 96 (in Russian)
- [3] Pure Appl.Chem. **2023**, 95, 133

STRUCTURE AND COMPOSITION OF CRYSTALS AND MOLECULES: NOVEL PHENOMENA AND THEIR EXPLANATION

*Oganov A.R.*

Skolkovo Institute of Science and Technology, Moscow, Russia  
*Dr.Sci., Professor, Professor of the Russian Academy of Sciences*  
[a.oganov@skoltech.ru](mailto:a.oganov@skoltech.ru)

I will discuss how the USPEX method, originally developed for crystal structure prediction, was extended to predict the composition of stable crystals and molecules. I shall describe examples of such predictions, including unusual high-pressure compounds.

Historically, electronegativity and chemical hardness have been particularly fruitful tools for chemical explanations and interpretations. In this lecture I shall recount the latest developments of these notions and their generalization to high pressures, which leads to explanation of a vast body of unusual high-pressure phenomena.

**Acknowledgements**

This work was supported by Russian Science Foundation (grant 19-72-30043).

## SCIENCE-INTENSIVE ECONOMY AND SYSTEMIC TECHNOLOGICAL TRANSFORMATION IN THE MODERN DEVELOPMENT OF THE CHEMICAL INDUSTRY

*Korableva O.N.<sup>1</sup>*

<sup>1</sup> St. Petersburg State University, St. Petersburg, Russia

*Dr. Sci., Professor, Member of the International Association Enterprise Architecture/Open Group*

[o.korableva@spbu.ru](mailto:o.korableva@spbu.ru)

Modern challenges determine the need to intensify both the economy of the country as a whole and specific industries, which can be implemented on the basis of the development of science-intensive areas. For the chemical industry, this area includes, among other things, low- and medium-tonnage chemistry.

The advantage of relying on science-based technologies is the possibility of reducing the time to achieve the planned results. This creates conditions for companies to increase their production potential, create an effective infrastructure, and form a personnel reserve.

The tasks assigned to the chemical industry will be solved within the framework of major projects, one of which is "Import substitution of critical technical products", scheduled to be launched in 2024. This project involves the creation of an ecosystem for the technological development of the chemical industry, the establishing of a network of chemical enterprises, scientific and personnel support for the industry, and, as a result, meeting the needs of the Russian economy in critical chemical products.

Various types of support are provided for the implementation of projects at all stages of development, ranging from subsidies at the R&D stage to the creation of cluster investment platforms, subsidizing credit rates, and the development of admission procedures for entering to foreign markets.

In general, the development of the chemical industry is carried out within the framework of the strategy of ensuring technological sovereignty and innovation-oriented growth.

The tasks of scientific and technological development of Russia have been defined in a number of fundamental documents, including the Conception of Technological Development of the Russian Federation until 2030, the Strategy of Scientific and Technological Development of the Russian Federation and a number of others.

Within the framework of the Conception, technological dynamics is considered as a condition for the socio-economic development of the country in accordance with the national development goals of the Russian Federation until 2030 and national interests. One of the most important tasks is to achieve technological sovereignty.

The development of the scientific and technological sphere is regarded in the context of the deployment of two system processes (meta-processes). The first is the development of science, the main purpose of which is to expand the circulation of new scientific knowledge within the framework of research and development. The main subjects of this meta-process are universities, scientific organizations, etc. The second is the development of the production system. As part of this process, a technological component is being formed in order to create added value, companies' capitalization and an increase of economic sustainability.

The main objective of the Conception is determined by the need to integrate these meta-processes, which will achieve a synergistic effect that has a positive impact on all areas of society's development. The integration includes a number of areas, consisting of the development of start-to-end technological priorities, whole motivation of participants, the creation of new forms of integration of research and production and technological activities, the spread of network forms of interaction, the cultivation of startups as a form of knowledge capitalization, and others.

The implementation of the tasks is carried out in the following areas: • launch of large megaprojects of technological sovereignty; • Strengthening the training of engineering teams; • Introduction of digital technologies.

Megaprojects are one of the most important mechanisms for technological development and achieving sovereignty in this area. Along with other areas, the list of megaprojects includes projects related to the localization of production of critically important chemical products in Russia.

On the whole, the implemented steps create conditions for ensuring national control over the production of priority technologies, innovative economic growth and sustainable development of production systems. In addition, it corresponds to the trend of systemic technological transition, which is aimed at integrated changes and co-evolution of socio-economic processes and technological innovation.



# **ADVANCED MATERIALS AND TECHNOLOGIES**



# **KEYNOTE & INVITED SPEAKERS**

## KEYNOTE SPEAKERS



**Dr. Sci., Prof. Pavel Postnikov**

*Research School of Chemistry & Applied Biomedical Sciences, Tomsk Polytechnic University, Tomsk, Russia*

**Plasmon-Assisted Chemistry: From Mechanisms to Application**

**Dr., Prof. Lei Wang**

*Harbin Institute of Technology, Harbin, China*

**Construction of Artificial-Cell-Based Micromotors and the Investigation of Their Life-Like Behaviors**



## INVITED SPEAKERS



**Dr., Prof. Jianmin Sun**

*Harbin Institute of Technology, Harbin, China*

**Design of Lewis Acid-Base Bifunctional Catalyst for Chemical Conversion of CO<sub>2</sub> to Cyclic Carbonate**

**Dr. Kirill Grzhegorzhevskii**

*Head of Laboratory of Nanocluster Polyoxometalates Functional Design, Institute of Natural Sciences and Mathematics, Ural Federal University named after the First President of Russia B.N. Yeltsin, Yekaterinburg, Russia*

**Hybrid Nanocluster-Embedded Hydrogels for The Controlled Drug Release and Bioink Application**



## PLASMON-ASSISTED CHEMISTRY: FROM MECHANISMS TO APPLICATION

*Postnikov P.S.*

Tomsk Polytechnic University, Tomsk, Russia

Professor

[postnikov@tpu.ru](mailto:postnikov@tpu.ru)

The plasmon-assisted transformations are a novel trend in the sustainable chemistry and engineering. The plasmon-based catalytic system is widely applied in the energy applications, decontamination of natural water, fine organic synthesis, dynamic covalent rebonding, et cetera [1]. Today, the implementation of plasmon resonance as a trigger allowed to perform formally "impossible" reactions under mild conditions [1-2].

In our report, the ongoing results of our group in the field of plasmon catalysis will be presented. Firstly, our findings in the mechanistic study of plasmon-catalyzed reactions will be discussed [2]. We will demonstrate the applicability of alkoxyamine homolysis as a close-to-perfect chemical probe for the mechanistic study of plasmon-initiated reactions.

The second part of the report will be dedicated to the applicability of plasmon initiation in fine chemical transformations, industrially important reactions, and materials science. It includes the spatially selective functionalization of nanomaterials using iodonium salts [3], proline-catalyzed aldol reaction at low temperatures [4], CO<sub>2</sub> coupling with epoxides that form carbonates [5] et cetera.

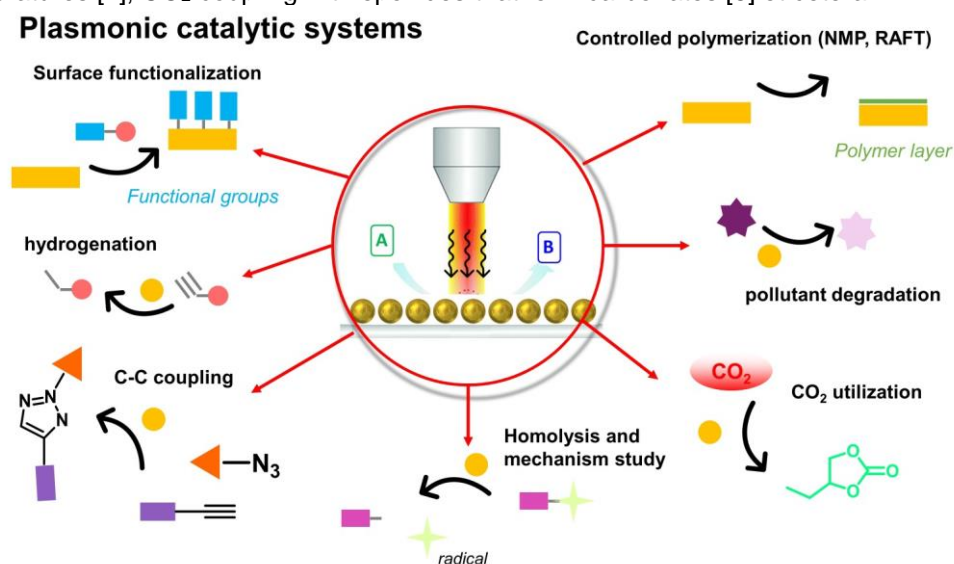

**Figure 1.** The applicability of plasmon-initiated reactions in chemistry and materials science.

### References

- [1] Acc. Chem. Res. 2019, 52, 2506; Chem. Rev. 2020, 120, 986; Nat. Rev. Meth. Prim. 2023, 3, 12; Prog. Polym. Sci. 2023, 144, 101726
- [2] J. Phys. Chem. Lett. 2020, 11, 5770; Chem. Sci., 2021, 12, 4154; ACS Catal. 2023, 13, 2822
- [3] Nanoscale, 2020, 12, 14581; 2D Mater., 2021, 8, 045037; Chem. Eng. J., 2023, 476, 146399
- [4] Nanoscale, 2024, 16, 5313
- [5] J. Mater. Chem. A, 2021, 9, 8462

### Acknowledgements

This work was supported by the Russian Science Foundation (project No. 23-73-00117).

## CONSTRUCTION OF ARTIFICIAL-CELL-BASED MICROMOTORS AND THE INVESTIGATION OF THEIR LIFE-LIKE BEHAVIORS

*Wang Lei*

School of Chemistry and Chemical Engineering, Harbin Institute of Technology, Harbin 150001, China  
Professor

[leiwang\\_chem@hit.edu.cn](mailto:leiwang_chem@hit.edu.cn)

Artificial-cell-based micromotors are new intelligent biomimetic materials based on multidisciplinary knowledge of chemistry, physics, synthetic biology, materials science, fluid mechanics and life science. Based on the "bottom-up" concept, through the design and integration of a variety of building elements, such as inorganic nanomaterials, functional polymers, biomaterials, etc., the multifunctional and multi-responsive micromotors can be realized, and the function and behavior of natural cells can be further simulated and studied; On the other hand, the artificial-cell-based micromotors can also be used as an intelligent building block to realize hierarchical assembly, so as to build advanced functional materials such as micro-scale or macro-scale artificial brake and artificial tissue, etc. Therefore, in-depth study of the structure, properties and functions of artificial cell models can not only lay the foundation for simulating natural cell functions, but also provide new ideas and new platforms for the design of new bionic materials.



**Scheme 1.** The motility styles of artificial-cell-based micromotors.

From the perspective of basic functions, motility behavior is not only an important function of cells, but also a criteria to measure the synergy of internal/external functions of cells. However, in the micro/nano scale, how to effectively design and construct artificial-cell-based micromotors with motility behavior by combining different knowledge of multiple disciplines is still a scientific problem in many fields. Therefore, in view of the above important scientific issues, this report will introduce the latest research progress of our research team in the field of "construction of artificial-cell-based micromotors and research on their life-like behaviors" [1-5], to show the design ideas and control strategies of artificial cell motion behavior, and to reveal the motility behavior law of artificial-cell-based micromotors in the field of life science and synthetic biology and its influences on multiple life functions, which provides a new research idea for further understanding the motility behavior of artificial cells and even the rapid proliferation mechanism and treatment methods of malignant cells such as tumors.

### References

- [1] Tang, M.; Ni, J.; Yue, Z.; Sun, T.; Chen, C.; Ma, X.; **Wang, L.\*** *Angew. Chem. Int. Ed.* **2024**, *63*, e202315031.
- [2] Chen, H.X.; Li, W.R.; Lin, Y.P.; **Wang, L.\***; Liu, X.M.; Huang, X. *Angew. Chem. Int. Ed.* **2020**, *59*, 16953.
- [3] **Wang, L.**; Marciello, M.; Gay, M.; Rodriguez, P. S.; Morato Y.; Fernandez J.I.; Huang, X.; Osuna S.; Filice M.; Sanchez, S. *Angew. Chem. Int. Ed.*, **2020**, *59*, 21080.
- [4] **Wang, L.**; Hortelao, A.C.; Huang, X.; Sanchez, S. *Angew. Chem. Int. Ed.*, **2019**, *58*, 7992-7996.
- [5] **Wang, L.**; Lin, Y.P.; Zhou, Y.T.; Xie, H.; Song, J.; Li, M.; Huang, Y.D.; Huang, X.; Mann, S. *Angew. Chem. Int. Ed.*, **2019**, *58*, 1067.

### Acknowledgements

This work was supported by the NSFC (project No. 52073071), and Natural Science Funding for Excellent Young Scholar of Heilongjiang Province (project No. YQ2022E021).



DESIGN OF LEWIS ACID-BASE BIFUNCTIONAL CATALYST FOR CHEMICAL CONVERSION OF CO<sub>2</sub> TO CYCLIC CARBONATE*Jianmin Sun\*, Lin Liang, Yifei Ye*

Harbin Institute of Technology, Harbin, China

[sunjm@jit.edu.cn](mailto:sunjm@jit.edu.cn)

Carbon dioxide as the main greenhouse effect gases has been attracting much attention as an abundant, inexpensive, nontoxic, and renewable C1 resource. The realization of an efficient catalytic process for CO<sub>2</sub> mitigation and transformation into value-added products is of great strategic significance. One of the most promising endeavors in this area is the cycloaddition of CO<sub>2</sub> to epoxides to yield cyclic carbonates, since it is green for 100% atom efficiency reaction, also the cyclic carbonate has wide potential applications ranging from the electrochemistry to pharmaceutical industries.

Based on the mechanism of CO<sub>2</sub> activation and conversion, a series of Lewis acid-base binary catalyst systems, including N-heterocyclic compound/ZnBr<sub>2</sub>, melamine/ZnI<sub>2</sub> and dicationic ionic liquids (ILs)/ZnI<sub>2</sub> were facilely designed and used for the catalytic coupling of CO<sub>2</sub> with epoxides to cyclic carbonates.

To avoid the use of cocatalyst in the cycloaddition of CO<sub>2</sub> and epoxide, the homogeneous single-component Zn-based task-specific ionic liquids (Zn-TSILs) catalysts with hydrogen bond donor site were developed. Also Zn-TSILs were proved to be versatile catalysts for catalytic conversion of CO<sub>2</sub> with various epoxides.

Transition metal ions with high-activity is still controversial on the environmental problems that triggered by the transition metal ions. Several metal-free urea derivative-based ionic liquids (UDILs) with superior thermal stability were facilely synthesized. It represents a much greener alternative to the transition metal ions for epoxide activation by introducing hydrogen bond donor groups. The UDILs overcome the defects of low synthesis efficiency and high energy consumption for traditional ionic liquids, and display a bi-functionality for both CO<sub>2</sub> capture and conversion.

To realize highly efficient separation of the catalyst, novel heterogeneous metal-free tri-s-triazine terminal-linked ionic liquids and periodic mesoporous organosilica with a basic urea-derived framework (PMO-UDF) were successfully synthesized on the base of UDILs. The materials as prepared possess multiple functionalities of hydrogen bond donor ability, Lewis base property, and nucleophilicity, which are vital to the ring-opening of epoxide and the activation of CO<sub>2</sub>. They could efficiently catalyze the coupling of CO<sub>2</sub> and epoxides to form cyclic carbonates under mild and solvent-free conditions, realizing the heterogeneous catalytic conversion of CO<sub>2</sub>. In addition, the developed PMO-UDFs exhibit an enhanced CO<sub>2</sub> capture capacity under ambient conditions due to the cooperative effects of the surface area and quantitative anchoring Lewis base units.

**References**

- [1] Jianmin Sun\* et al. Separation and Purification Technol. **2024**, 344, 127061
- [2] Jianmin Sun\* et al. Catalysis Rev. **2023**, <https://doi.org/10.1080/01614940.2023.2202528>
- [3] Jianmin Sun\* et al. J. CO<sub>2</sub> Util. **2023**, 67, 102325
- [4] Jianmin Sun\* et al. J. Colloid and Interface Sci. **2022**, 618, 44
- [5] Jianmin Sun\* et al. Current Opinion in Green and Sustainable Chem. **2022**, 34, 100599
- [6] Jianmin Sun\* et al. Chem. Eng. J. **2022**, 427, 131633
- [7] Jianmin Sun\* et al. J. Catal. **2017**, 347, 138
- [8] Jianmin Sun\* et al. Green Chem. **2016**, 18, 2851

**Acknowledgements**

This work was supported by the National Natural Science Foundation of China (No. 21972034) and Heilongjiang Touyan Team (HITTY-20190033)

## HYBRID NANOCLUSTER-EMBEDDED HYDROGELS FOR THE CONTROLLED DRUG RELEASE AND BIOINK APPLICATION

*Grzhegorzhevskii K.V.*<sup>1</sup>, *Levchenko A.E.*<sup>1</sup>, *Kopchuk D.S.*<sup>1,2</sup>, *Nikonov I.L.*<sup>1,2</sup>, *Valieva M.I.*<sup>1,2</sup>, *Borovykh D.V.*<sup>1</sup>

<sup>1</sup> Ural Federal University named after the First President of Russia B.N.Yeltsin, Ekaterinburg, Russia

<sup>2</sup> I. Postovsky Institute of Organic Synthesis Ural Branch of RAS, Ekaterinburg, Russia  
Ph.D.

[kirillvalentinovich@urfu.ru](mailto:kirillvalentinovich@urfu.ru)

The rational design of hydrogel and hybrid polymer systems is one of the most challenging tasks in the field of smart materials. In this context, the control of the supramolecular structure is an essential step towards the creation of adaptive biocompatible materials for wound regeneration and living cell bioprinting. Using the template effect of giant Keplerate type polyoxometalate (POM) {Mo<sub>132</sub>}, we can tune the supramolecular assembly of macromolecules and bioactive compounds that form the hydrogel with pH-controlled release properties. From one hand, acting as a labile dynamic linker, Keplerate can affect the rheological behaviour of the polymer solution, bringing the non-Newtonian behaviour. On the other hand, the POM can be modified by a variety of covalent and non-covalent interactions<sup>1-3</sup>, altering the structure of the 3D polymer network. As a result, we made the multilayer hydrogel patch with adjustable properties to prolonged release of the quorum sensing inhibitors, antibiotics and anaesthetics for wound healing.

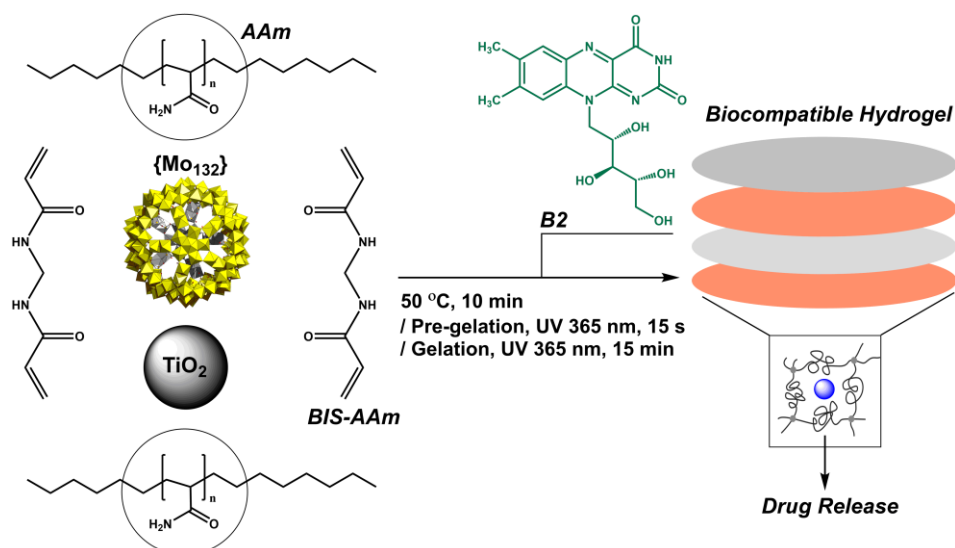

**Scheme 1.** The preparation of the hybrid hydrogel with embedded Keplerate {Mo<sub>132</sub>} for controlled drug release.

The adaptive behaviour of the POM-embedded polymer system can be extended to bioink production, where the other Keplerate {Mo<sub>72</sub>Fe<sub>30</sub>} reversibly links macromolecules through coordination to the acyloin group involved in tautomeric equilibrium. Due to its large surface area, Keplerate can both cross-link the polymer network and carry the bioactive compound to facilitate cell growth. This approach is a powerful strategy for living cell printing, where the polymer matrix acts as a biocompatible scaffold for tissue engineering.

### References

- 1 V. Fazylova, N. Shevtsev, S. Mikhailov, G. Kim, A. Ostroushko and K. Grzhegorzhevskii, *Chem. – A Eur. J.*, 2020, **26**, 5685–5693.
- 2 K. V. Grzhegorzhevskii, A. D. Denikaev, M. V. Morozova, V. Pryakhina, E. Khairullina, I. Tumkin, O. Taniya and A. A. Ostroushko, *Inorg. Chem. Front.*, 2022, **9**, 1541–1555.
- 3 A. Denikaev, Y. Kuznetsova, A. Bykov, A. Zhilyakov, K. Belova, P. Abramov, N. Moskalenko, E. Skorb and K. Grzhegorzhevskii, *ACS Appl. Mater. Interfaces*, 2024, **16**, 7430–7443.

### Acknowledgements

This work was supported by the Russian Science Foundation (project No. 23-73-10158).



# **ORAL & POSTER PRESENTATIONS**

## ION TRANSPORT OF 3d-METAL DOPED LAYERED PEROVSKITES BASED ON BaLaInO<sub>4</sub>

*Abakumova E.V.*<sup>1,2</sup>, *Bedarkova A.O.*<sup>1,2</sup>, *Tarasova N.A.*<sup>1,2</sup>,  
*Animitsa I.E.*<sup>1,2</sup>

<sup>1</sup> Institute of High Temperature Electrochemistry RAS, Ekaterinburg, Russia

<sup>2</sup> Ural Federal University, Ekaterinburg, Russia

PhD student

[e.v.abakumova@urfu.ru](mailto:e.v.abakumova@urfu.ru)

The interest in alternative energy production methods has not waned in recent times because of the difficulties associated with traditional production (limited earth resources, harmful emissions into the air, waste recycling, etc.). Hydrogen energy is one of these alternative forms of energy production. The concept of hydrogen energy is to convert the chemical energy of fuel cells into electrical energy. Among the known fuel cells, solid oxide fuel cells are an important area of research. SOFCs have a number of advantages over other fuel cells. For example, SOFCs have relatively low electrode polarisations and correspondingly high current densities, the absence of liquid components, etc. One of the key elements of the SOFC is the electrolyte. The electrolyte is the link between the cathode and the anode. One of the main requirements of the electrolyte material is to allow ions (O<sup>2-</sup>, H<sup>+</sup>) to pass between each other. Therefore, when looking for compounds for an electrolyte, you need to choose substances that have predominantly ionic transport.

Among the known structures, perovskites and derived structures are the most studied in terms of transport properties. The Ruddlesden-Popper (RP) structure is related to perovskite. The structure of the RP consists of layers of octahedra and interlayer space. The perovskite structure (a) and the RP structure (b) are shown in Figure 1.

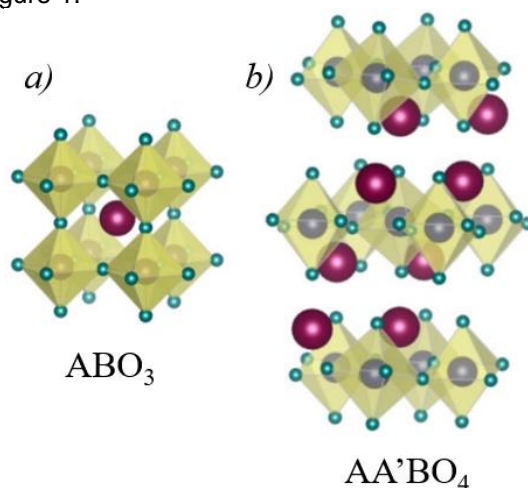

**Figure 1.** Visualization of perovskite structure (a) and Ruddlesden-Popper structure (b) [1].

In 2015, the transfer of O<sup>2-</sup> ions into the RP-structured BaNdInO<sub>4</sub> compound was discovered [2]. And a few years later, the possibility of proton transfer was demonstrated in the compound BaLaInO<sub>4</sub>, which has the same structure [3,4]. In order to research the processes of ion transfer (O<sup>2-</sup>, H<sup>+</sup>) and to increase the conductivity, isovalent doping of La<sup>3+</sup> ions onto REE<sup>3+</sup> ions was carried out. Doping with Sm<sup>3+</sup> ions has been shown to increase the proton conductivity by up to 2 orders of magnitude at 420 °C. The Sm-doped composition has the best proton conductivity among other REE-doped samples.

### References

- [1] *Membranes*. **2023**, 13, 34
- [2] *Mat. Chem. A* **2015**, 3, 11985
- [3] *Ionics*. **2020**, 26, 5075
- [4] *Solid State Electrochem.* **2020**, 24, 1497

### Acknowledgements

This work was supported by the Russian Science Foundation (project No. 22-79-1003).

# DESIGN OF ELECTRON-TRANSPORT MATERIALS FOR WIDE-BANDGAP PEROVSKITE SOLAR CELLS

*Agapitova M.M.<sup>1,2</sup>, Tepliakova M.M.<sup>1</sup>*

<sup>1</sup> Skoltech Institute of Science and Technology, Moscow, Russia

<sup>2</sup> D. Mendeleev University of Chemical Technology of Russia, Moscow, Russia

Student (4-year BSc)

[agapitovamary5@gmail.com](mailto:agapitovamary5@gmail.com)

Over the past ten years, indoor photovoltaic devices have come in the spotlight due to hectic development of Internet of Things (IoT) [1] and increasing demand for wireless power supplies for low-power and portable devices. It is not a secret that in order to obtain a stable and highly efficient perovskite solar cell (PSC), one of the most effective methods is to find a suitable electron-transport layer (ETL). The conduction band of wide-bandgap (WBG) perovskites is shallower compared to classical materials, which implies certain requirements for ETLs electronic structure. However, mostly research groups have used WBG perovskite-based devices the same ETLs (in particular c-TiO<sub>2</sub>/m-TiO<sub>2</sub>) as for CH<sub>3</sub>NH<sub>3</sub>PbI<sub>3</sub> [2-3]. This may lead to energy levels misalignment, hence undesirable energy losses and decrease of V<sub>oc</sub> [4]. Hence, it's crucial to focus on novel ETLs design to achieve remarkable progress in performances and stability of WBG indoor photovoltaics.

In this work, we investigated, set of ETLs with different passivating agents in PSCs with a WBG perovskite layer with Cs<sub>0.17</sub>FA<sub>0.83</sub>Pb(I<sub>0.6</sub>Br<sub>0.4</sub>)<sub>3</sub>. Films of ZnO, c-TiO<sub>2</sub>, SnO<sub>2</sub> were fabricated using various techniques including spin-coating, doctor blading, and physical vapor deposition. To suppress chemically active sites on the surface of metal oxide films we applied different passivation agents, such as various fullerene derivatives (PCBA, PCBM, C<sub>60</sub>) and amino-based interfacial modifiers: monoethanolamine (EA), ethylenediamine (EDA). All ETLs were thoroughly characterized using a set of techniques such as absorption spectroscopy, cyclic voltammetry, X-ray photoelectron spectroscopy, atomic force microscopy. The operation stability of promising photovoltaic devices with different ETLs was studied under incessant light soaking during more than 2300 hours (Fig. 1).

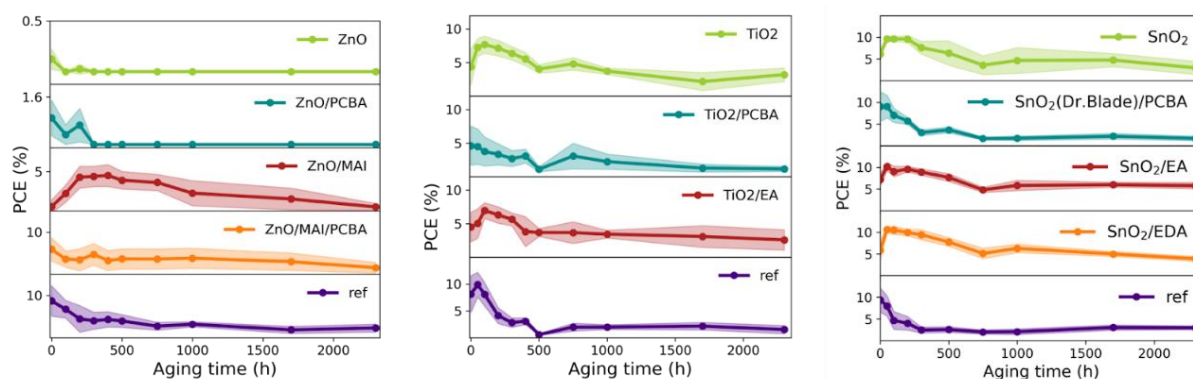

**Figure 1.** Evolution of characteristics of WBG PSCs with different ETLs under continuous illumination AM 1.5 G (equivalent of 1 SUN) and inert atmosphere.

It was found that passivation with fullerene-containing materials enables high power conversion efficiencies (PCEs) up to 13.2% at AM 1.5G (1 SUN) and 22.5% under indoor artificial light (1000 lux), but adversely affects the stability. On the other hand, PSCs with SnO<sub>2</sub> deposited from solution passivated with EA and EDA possessed long-term operational stability with 29% loss of PCE after 1700 hours of constant illumination. This work lays a foundation for the rational design of ETLs for WBG perovskite photovoltaics.

## References

- [1] *InfoMat.* **2021**, 3, 446
- [2] *Mater. Adv.* **2021**, 2, 6345
- [3] *Adv. Energy Mater.* **2017**, 7, 1701048
- [4] *ACS Energy Lett.* **2016**, 1, 2, 428

## Cr-DOPED SnO<sub>2</sub> NANOPARTICLES: INFLUENCE OF SYNTHESIS CONDITIONS AND STRUCTURAL PARAMETRES ON PHOTOCATALYTIC ACTIVITY

*Agapov I.V., Podurets A.A., Osmolowsky M.G., Bobrysheva N.P., Voznesenskiy M.A., Osmolovskaya O.M*

St. Petersburg State University, St. Petersburg, Russia  
Student

[ivann.agapov@gmail.com](mailto:ivann.agapov@gmail.com)

Water purification becomes a main improvement tool of sanitarian and epidemiological state of the environment. However, the water pollution problem is increasing drastically due to active global urbanization processes and conventional methods faces serious problems due to large-scale production of hazardous organic pollutants. Nowadays the major entry route in the environment is the wastewater of various manufactories, such as textile production. In this regard, it is necessary to develop fast and eco-friendly utilization. Semiconductor photocatalysis using doped SnO<sub>2</sub> nanoparticles is a modern technique which has received tremendous attention as a cutting-edge approach for waste-free water purification.

Doping of SnO<sub>2</sub> with rutile-type crystal structure, tolerant to substitution, with 3d metals is a widespread way to improve the photocatalytic efficiency and also to provide additional functional properties, such as luminescence, in order to provide a monitoring of the photocatalyst stability and reusability. Among various 3d metals Cr<sup>3+</sup> is the only affordable and profitable from an economic point of view dopant which can be used to obtain multifunctional photocatalyst. However, aspects concerning regulation of photocatalytic properties in order to improve the degradation efficiency are still unresolved. The aim of this research is to investigate the relationship "synthesis conditions, structural parameters, and photocatalytic properties" for Cr-doped SnO<sub>2</sub> nanoparticles (NPs).

Co-precipitation method and its combination with post-synthetic hydrothermal treatment (HTT) led to the synthesis of nanoparticles of spherical and cubic shape, respectively. Synthesis was performed using pH 3 and 7, dopant concentrations varied from 11 mol% and 33 mol%.

As-prepared NPs were characterized by a complex of physico-chemical methods. According to XRD data, all samples represent the rutile-type structure, no additional phases were observed. Successful doping was confirmed by changes in lattice parameters, hydrothermal treatment led to an increase in crystallinity. According to HR-TEM and SAED data, 4 nm spherical and cubic nanoparticles with polycrystalline structure can be observed, while EDX results indicate a uniform distribution of dopant in the structure.

The band gap energy, including direct and indirect transitions, was analyzed by absorption spectroscopy, which was confirmed by quantum-chemical calculations using our original approach. The amount of defects and oxygen vacancies was determined using XPS and Raman spectroscopy, respectively. It was shown that hydrothermal treatment reduces the amount of defects. An original computational approach was used to determine the optimal dopant position of substitution based on quantum-chemical calculations using DFT method, considering our dopant concentrations. It was found that the dopant position and the composition of the reaction medium affect the morphological parameters of nanoparticles. Moreover, various dopant concentrations allow us to regulate amount of oxygen vacancies and defects.

A comprehensive study of photocatalytic properties on the example of methylene blue (MB) under UV-light was performed according to our developed protocol, which includes several stages: study of kinetics of photodegradation and dark adsorption, investigation of surface composition by FTIR method, quantum chemical calculations of the interaction energy between NPs surface and pollutant molecule, study of mass spectra of by-products, investigation of active species by scavenger test and reusability properties by stability test.

Optimal sample with 11 mol% of dopant, obtained at pH 3, demonstrate 88% of MB decomposition in 90 minutes. It was shown that the efficiency of photocatalysis is affected by the expression of the "dye molecule- photocatalyst surface" interaction.

Thus, multifunctional NPs Cr-doped SnO<sub>2</sub> can be used as promising material for recyclable and effective wastewater treatment.

### **Acknowledgements**

Scientific research was performed at the research park of St. Petersburg State University: Centre for X-ray Diffraction Studies, Centre for Innovative Technologies of Composite Nanomaterials, Chemical Analysis and Materials Research Centre, Centre for Physical Methods of Surface Investigation, Computing Centre, Centre for Optical and Laser Materials Research, and Interdisciplinary Resource Centre for Nanotechnology

## CARBON DOT/CHITOSAN NANOCRYSTAL HYBRID FOR WASTEWATER DYE REMOVAL

*Aliyu B.O.<sup>1</sup>, Tracey C.T., Krivoschapkin P.V.<sup>1</sup>, and Krivoschapkina E.F.<sup>1</sup>*

<sup>1</sup>ITMO University, SCAMT, St. Petersburg, Russia  
Graduate Student, Energy Lab  
[aliyu@scamt-itmo.ru](mailto:aliyu@scamt-itmo.ru)

The rapid expansion of the dye industry has had a significant impact on water quality, which in turn negatively affects human, animal, and environmental health. Consequently, several techniques have been investigated for dye removal, including dye photodegradation and the adsorption of degradation products, which has proven to be a cheap yet effective approach to wastewater treatment. A biodegradable photocatalytically active carbon dot/chitosan nanocrystal sorbent was fabricated by synthesizing carbon dots directly on the surface of chitosan nanocrystals, which acted as both a carbon and nitrogen source as well as a supporting material [1–4]. The resulting hybrid degraded methyl violet, a common wastewater pollutant, within 30 min under lamp light (**Figure 1**) and showed good adsorption for both the dye and degradation products at low loading catalyst values, indicating good photocatalytic activity and good sorption capacity. The hybrid is also easily removed after treatment, making it an effective, environmentally friendly approach to wastewater treatment.

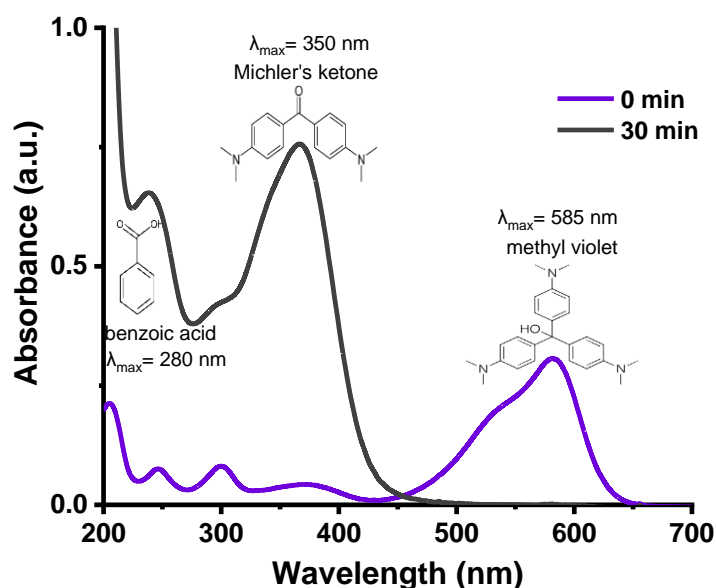

**Figure 1.** Degradation of dye over a 1-week period under lamp.

### References

- [1] Liu J., Li R., Yang B. Carbon Dots: A New Type of Carbon-Based Nanomaterial with Wide Applications // *ACS Central Science*. 2020. № 12 (6). C. 2179–2195.
- [2] Ngo T. S., etc. Reusable carbon dot / chitin nanocrystal hybrid sorbent for the selective detection and removal of Cr (VI) and Co (II) ions from wastewater // *Carbohydrate Polymers*. 2023. № November 2022 (304). C. 120471.
- [3] Ozyurt D., etc. Properties, synthesis, and applications of carbon dots: A review // *Carbon Trends*. 2023. (12). C. 100276.
- [4] Villalba-Rodríguez A. M., etc. Chitosan-Based Carbon Dots with Applied Aspects: New Frontiers of International Interest in a Material of Marine Origin // *Marine Drugs*. 2022. № 12 (20). C. 782.

### Acknowledgements

This work was supported by the Russian Ministry of Science and Higher Education “Science and Universities” National Project state task № FSER-2022-0002. K.E.F. also acknowledges the Priority 2030 Federal Academic Leadership Program for infrastructural support.

# THE EFFECT OF SIBUNITE TREATMENT IN NO ON THE CATALYTIC PROPERTIES OF Pd/C CATALYSTS IN THE FORMIC ACID DECOMPOSITION

*Ananina A.A.<sup>1</sup>, Nartova A.V.<sup>1</sup>, Semikolenov S.V.<sup>1</sup>, Kovtunova L.M.<sup>1</sup>, Dmitrachkov A.M.<sup>1</sup>, Kvon R.I.<sup>1</sup>, Sobolev V.I.<sup>1</sup>, Bukhtiyarov V.I.<sup>1</sup>*

<sup>1</sup>Boreskov Institute of Catalysis, Novosibirsk, Russia

Graduate student

[a.ananina@catalysis.ru](mailto:a.ananina@catalysis.ru)

One of the topical issues of heterogeneous catalysis is the effect of the catalyst support on the properties of catalytic systems. It has been repeatedly shown that the introduction of nitrogen into the composition of carbon supports leads to a change in the properties of catalysts: it increases thermal stability with respect to sintering, changes surface properties, and, as a result, affects the catalytic activity and selectivity of systems [1]. The use of nitrogen-doped carbon supports is considered promising in various catalytic processes, in particular, in the decomposition of formic acid [2].

The aim of this work is to develop a controlled procedure for the introduction of nitrogen into the composition of a carbon support (Sibunite) in order to improve the catalytic properties of palladium catalysts in the formic acid decomposition reaction.

We prepared a series of Sibunite samples modified in a static Parr-reactor in the presence of NO in gas phase varying treatment conditions (composition and pressure of the gas phase, treatment temperature and duration). Using the X-ray photoelectron spectroscopy (XPS), it was found that treatment in NO leads to the introduction of nitrogen into the carbon material, and several nitrogen states can be distinguished: pyridinic (binding energy of 399.0 eV), pyrrolic (400.3 eV), -NO (402.9 eV) and -NO<sub>2</sub> (406.0 eV). Processing conditions affect the total nitrogen and oxygen content as well as the ratios of species. Obtained data allowed proposing the mechanism of modification of the Sibunite in presence of NO as a process of etching of carbon material layers by the etching of the layer edges. Therefore, at low temperatures, nitrogen is introduced mainly in the form of -NO<sub>x</sub> groups; but with a temperature increase, the introduction of nitrogen into the carbon matrix intensifies [3].

The analysis of transmission electron microscopy (TEM) data for Pd/Sibunite and Pd/N-Sibunite was carried out using neural networks of the DLgram service of the iOk Platform [4]. High-resolution TEM images of Pd/Sibunite catalysts show single atoms and small clusters along with nanoparticles. According to TEM data, the average size of Pd particles in Pd/N-C catalysts is  $1.9 \pm 0.0$  nm, and  $2.0 \pm 0.1$  nm in Pd/C. Despite the close values of the average particle sizes, an analysis of the particle size distribution (PSD) histograms shows that in the case of Pd/N-C catalyst it is possible to obtain a narrow PSD, whereas for Pd/C catalyst the distribution has a lengthy "tail" of large particles. The data obtained indicate the stabilization of palladium with respect to sintering on nitrogen-modified Sibunite at the preparation stage. The comparison of XPS data for Pd/N-C and Pd/C catalysts shows that palladium is coordinated with nitrogen centers on the surface of the nitrogen doped carbon support. According to the literature, such interaction can explain the stability of palladium single atoms and nanoparticles [5].

For the formic acid decomposition reaction, it was shown that although the effect of nitrogen support modification on selectivity is weakly expressed, the conversion of formic acid increases (38.2% vs. 26.5%) with the use of a nitrogen doped carbon support.

Thus, the one-stage procedure of carbon support nitrogen doping is developed. The mechanism of modification in presence of NO in the gas phase is assumed. Proposed mechanism provides the key to the controlled N-modification of carbon supports and catalysts on its base.

Comparison of Pd/Sibunite and Pd/N-Sibunite catalysts indicates improving stability of palladium particles on the surface of the modified support under reduction treatment conditions during sample preparation, as well as the effect of support modification on the increase of the conversion of formic acid in decomposition reaction.

## References

- [1] *Chemistry of Materials*. **2017**, 29, 8670-8678
- [2] *ChemSusChem*. **2017**, 10, 720-730
- [3] *Kinet. Catal.* **2023**, 64, 466–472
- [4] *Kinet. Catal.* **2023**, 64, 458-465
- [5] *Energies*. **2021**, 14, 1501

## Acknowledgements

This work was supported by the Ministry of Science and Higher Education of the Russian Federation within the governmental order for Boreskov Institute of Catalysis (project FWUR-2024-0032).



# PHOTOPROTECTIVE AND PHOTOCATALYTIC PROPERTIES OF COMPLEX CERIUM AND TITANIUM OXIDES

*Arbanas S.<sup>1</sup>, Kolesnik I.V.<sup>1,2</sup>*

<sup>1</sup> Moscow State University, Moscow, Russia

<sup>2</sup>Kurnakov Institute of General and Inorganic Chemistry of the Russian Academy of Sciences, Moscow, Russia

Student

[s-arb@mail.ru](mailto:s-arb@mail.ru)

Photoprotective inorganic pigments have found extensive use in the production of decorative and care cosmetics. Currently, the most common representatives of such pigments are titanium and zinc oxides [1]. The main problem with the use of pure oxides is their high photocatalytic activity: under solar irradiation pigments can produce reactive oxygen species which damage components of cosmetics and skin cells [2]. Therefore, it is necessary inhibit photocatalytic activity of cosmetic inorganic pigments. This can be achieved by adding an antioxidant to the product [2][3][4]. CeO<sub>2</sub> is one example of an antioxidant that absorbs free radicals [5][6], with photoprotective properties comparable to TiO<sub>2</sub> [2][4].

The purpose of this work was to optimize the synthesis of composite inorganic oxide pigments based on complex titanium and cerium oxides with a ratio of Ti:Ce=1:1, to create a model cosmetic product based on them and to study their photoprotective properties.

Hydrothermal synthesis was chosen to obtain weakly aggregated nanocrystalline materials. Hexachlorotitanic acid and cerium (III) chloride were chosen as precursors containing titanium and cerium. NaOH and KOH were used as reagents regulating the acidity of the environment.

The were characterized by powder X-ray diffraction and transmission electron microscopy. The samples consist of Ce<sub>2</sub>Ti<sub>2</sub>O<sub>7</sub>, Ce<sub>2/3</sub>TiO<sub>3</sub>, CeO<sub>2</sub> phases. During the washing procedure, the composition of the samples, changes: the content of CeO<sub>2</sub> increases, while the content of Ce<sub>2</sub>Ti<sub>2</sub>O<sub>7</sub> decreases. Samples containing phases of cerium titanate are characterized by the highest values of photoprotective properties, and at the same time have insignificant photocatalytic activity.

The color characteristics were determined according to the international standard ISO 11664-4.

During the work, emulsions based on a number of emulsifiers were obtained. The "water-in-oil" emulsion was prepared on a mixture of polyglyceryl-3 polycyanoate and polyglyceryl-3 ricinoleate. The emulsion remains stable at the content of the oxide phase (TiO<sub>2</sub>) from 0 to 5 wt.%. However, it loses its stability when complex oxides of titanium and cerium are introduced into its composition. "Oil-in-water" emulsions based on Montanov-68 and SPAN-60 emulsifiers proved to be unstable to the introduction of solid particles. However, stable emulsions containing TiO<sub>2</sub> particles and cerium titanate particles were obtained using the arginine salt of cetyl phosphate as an emulsifier.

The photoprotective properties of suspensions of cerium titanates based on glycerol and model cosmetics – emulsions based on arginine salt of cetyl phosphate were characterized in accordance with ISO 24443-2016. The photoprotective activity of pigments dispersed in an emulsion correlates well with the photoprotective properties of suspensions of the same pigments in glycerol. The SPF of cerium titanates was 1.8-2.5 times higher than the photoprotective activity of commercial pigments.

This made it possible to create products with an SPF value of up to 8. Thus, the cerium titanate synthesized in our work can be considered as a promising pigment with high photoprotective characteristics, and the arginine salt of cetyl phosphate is currently considered the most promising emulsifier.

## References

- [1] Smijs T.G., Pavel S., "Titanium dioxide and zinc oxide nanoparticles in sunscreens: Focus on their safety and effectiveness", *Nanotechnol. Sci. Appl.*, 2011, 4, pp. 95–112.
- [2] Herrling T., et al. "Cerium dioxide: Future UV-filter in sunscreen?", *SOFW J.*, 2013, 139, pp. 10–14.
- [3] Shcherbakov A.B., Zholobak N.M., Ivanov V.K., Scire S., Palmisano L., "Biological, Biomedical and Pharmaceutical Applications of Cerium Oxide. In *Cerium Oxide (CeO<sub>2</sub>): Synthesis, Properties and Applications*", Elsevier: Amsterdam, The Netherlands, 2020, pp. 279–358.
- [4] Zholobak N.M., et al., "UV-shielding property, photocatalytic activity and photocytotoxicity of ceria colloid solutions", *J. Photochem. Photobiol. B: Biology*, 2011, V. 102(1), pp. 32–38.
- [5] Niu J., et al., "Cardioprotective effects of cerium oxide nanoparticles in a transgenic murine model of cardiomyopathy", *Cardiovasc. Res.*, 2007, V. 73, pp. 549-559
- [6] Das M., et al., "Auto-catalytic ceria nanoparticles offer neuroprotection to adult rat spinal cord neurons", *Biomaterials*, 2007, V. 28, pp. 1918-1925.

## Acknowledgements

This work was supported by the Russian Science Foundation (project No 23-73-10088).

# POLYMER / CARBON NANOTUBES COMPOSITES AS WATER-PROCESSABLE BINDERS FOR LI-ION BATTERY ELECTRODES

*Asharchuk A.A.<sup>1</sup>, Kubarkov A.V.<sup>1</sup>, Sergeyev V.G.<sup>1</sup>*

<sup>1</sup>Lomonosov Moscow State University, Moscow, Russia  
Student

[asharchuk.artem@mail.ru](mailto:asharchuk.artem@mail.ru)

Today, lithium-ion batteries are widely used. However, they have a number of disadvantages, including high manufacturing costs and high environmental impact. The development of water-soluble polymer binders for battery electrodes can serve as one of the ways to eliminate these shortcomings, since they make it possible to obtain electrodes without the use of organic solvents [1].

In this work, positive electrodes for lithium-ion batteries based on LiFePO<sub>4</sub> were obtained; single-walled carbon nanotubes were used as a conductive component; water-soluble hydrolyzed polyacrylonitrile and carboxymethylcellulose were used as binders. To achieve good capacity and cycling performance, it is important to obtain stable dispersions of the conductive component in the electrode suspension. It was found that stable dispersions with carbon nanotubes in an aqueous solution of hydrolyzed polyacrylonitrile are formed at pH≈5. In the case of carboxymethylcellulose, dispersions are formed in a wide pH interval. The properties of the resulting electrode are significantly influenced by the acid used to reduce the acidity of the initial solution of the polymer binder. LiFePO<sub>4</sub> particles and the current collector are more stable in the presence of CH<sub>3</sub>COOH and H<sub>3</sub>PO<sub>4</sub> than in HCl, which makes it possible to achieve high values of specific capacity. The effect of the separator on the cycling performance of the electrode was also investigated.

As a result, specific cathode capacitance of 160 mAh g<sup>-1</sup> was achieved, which is close to the theoretical value for LiFePO<sub>4</sub> of 170 mAh g<sup>-1</sup>. It was found that the electrodes prepared from polymer solutions with fully dispersed carbon nanotubes had a larger capacity at high current densities and a more uniform distribution of carbon nanotubes in the composite [2]. The use of a separator that prevents the growth of lithium dendrites had a positive effect on the stability of the battery capacity, so the loss of capacity over 100 charge-discharge cycles was less than 2%.

## References

- [1] Energy & Environmental Science **2018**, 11, 3096
- [2] ACS Applied Energy Materials **2021**, 4, 12310

## Acknowledgements

This work was supported by the Russian Science Foundation (project No 24-13-00107).

## PREPARATION OF NANOFIBROUS MATS AND THEIR IN-VITRO ASSESSMENTS IN THE TREATMENT OF PARKINSON'S DISEASE

*Baghali M.<sup>1</sup>, Ziyadi H.<sup>2</sup>, Ghaffarimoghadam M.<sup>3</sup>, Sadri D.<sup>3</sup>*

<sup>1</sup> Research School of Chemistry & Applied Biomedical Sciences, Tomsk Polytechnic University, Lenin Avenue 43, 63400, Tomsk, Russian Federation

<sup>2</sup> Department of Organic Chemistry, Faculty of Pharmaceutical Chemistry, Tehran Medical Sciences, Islamic Azad University, Tehran, Iran

<sup>3</sup> Department of Pharmaceutical Chemistry, Faculty of Pharmaceutical Chemistry, Tehran Medical Sciences, Islamic Azad University, Tehran, Iran  
PhD student, Junior Researcher

[bm03@tpu.ru](mailto:bm03@tpu.ru)

Nanofibers, composed of natural, synthetic, or hybrid polymeric materials, possess remarkable qualities such as high porosity, ease of modification and manipulation, extensive surface area, superior encapsulation efficiency, and enhanced thermal and chemical stability, rendering them highly advantageous in medical research [1]. Various methods have been employed for the production of polymeric nanofibers, including spinneret-based tunable engineered parameter (STEP) method, freeze-drying synthesis, template synthesis, phase separation, drawing techniques, interfacial polymerization, self-assembly, and electrospinning [2]. Among these, electrospinning has emerged as a prominent and versatile technique due to its simplicity and versatility, allowing for the production of diverse types of nanofibers, including composites, core-shell fibers, net fibers, blends, and hybrids [3]. Extensive studies have explored the utilization of electrospun fibers in various biomedical applications, with particular emphasis on drug delivery, notably transdermal drug delivery. Electrospun nanofibers offer numerous advantages, including high encapsulation efficiency (>100%), substantial drug loading capacity (>60%), and the ability to deliver multiple therapeutic agents simultaneously [4]. This study aimed to fabricate PVA/PVP nanofiber mats using an electrospinning device as carriers for pramipexole, and evaluate their therapeutic efficacy and pharmacological effects in treating Parkinson's disease in rats, comparing them with the conventional oral form of the drug. The nanofiber mats underwent comprehensive characterization through viscosity analysis, SEM imaging, FT-IR spectroscopy, and contact angle measurements. In vivo experiments were conducted using a paraquat-induced Parkinson's disease mouse model, and behavioral assessments, including open field, bar test, and rotarod tests, were employed to assess the therapeutic impact of pramipexole nanofiber patches. Subsequently, the nigrostriatal region of the brain was isolated to evaluate oxidative stress, inflammatory responses, apoptosis, and histological parameters. The results indicated that the nanofiber mats, similar to the oral form of the drug, significantly alleviated symptoms and motor disorders induced by paraquat in male mice. Furthermore, pramipexole administration via both transdermal and systemic routes showed potential in attenuating paraquat-induced neurodegeneration in the nigrostriatal region.

### References

- [1] *Artif. Organs.* **2019**, 43, 780
- [2] *J. New Mater. Electrochem. Syst.* **2020**, 23, 151
- [3] *ACS Appl Energy Mater.* **2021**, 4, 8529
- [4] *J. Controlled Release.* **2014**, 185, 12

### Acknowledgements

The others would like to thank Islamic Azad University, Tehran Medical sciences and Tomsk Polytechnic University.

## «IDEAL»: DIAMOND-CARBIDE-SILICON COMPOSITE FOR LIGHTWEIGHT CERAMIC ARMOR PROTECTION

*Balabanov S.V.<sup>1</sup>, Sychov M.M.<sup>1</sup>, Perevislov S.N.<sup>2</sup>*

<sup>1</sup> NRC "Kurchatov Institute" – Institute of Silicate Chemistry, St. Petersburg, Russia

<sup>2</sup> NRC "Kurchatov Institute" - CRISM "Prometey", St. Petersburg, Russia

Postgraduate

[sergeybalabanov@yahoo.com](mailto:sergeybalabanov@yahoo.com)

“Ideal” is a new type of reaction-sintered composite material. “Ideal” composite is obtained by reaction sintering by filling the pores of the diamond particle blank with liquid silicon melt until a monolithic structure is obtained. Due to the almost complete absence of pores and strong interfacial bonding, the “Ideal” composite has high physical and mechanical characteristics.

The paper investigates the protective properties of two-layer armor panels based on ceramic material “Ideal” in comparison with armor panels including corundum armor plates. The fractional composition of fragments formed after dynamic testing of armor panels was evaluated. The total surface energy of the formed fragments has been determined. It is shown that Ideal ceramics (diamond-silicon carbide composite) is close to an ideally brittle material, to which it provides effective dissipation of kinetic energy and indenter destruction. It was found that Ideal ceramics is characterized by predominantly transcrystalline fracture, which proves the high strength of interphase bonds in the material (fig.1).

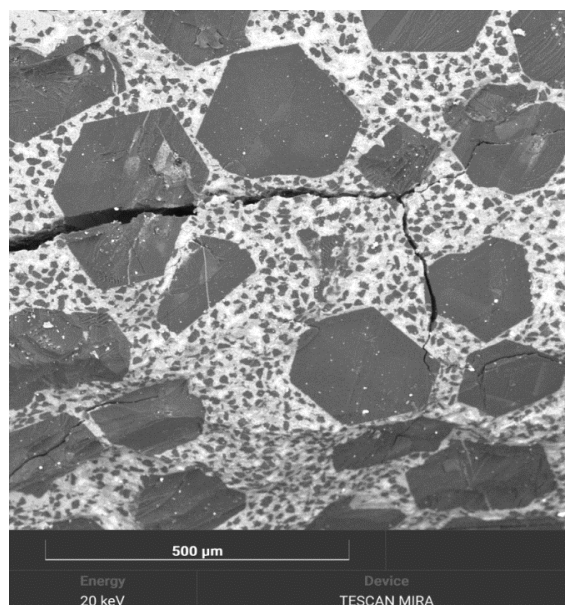

**Figure 1.** Transgranular fracture of “Ideal” ceramics.

«Ideal» ceramic has unique mechanical characteristics, in particular, it has extremely low Poisson's ratio  $\mu=0.008$ , so it can be stated that this ceramic is close to an ideally brittle material [1,2]. Due to this, «Ideal» ceramic provides more efficient absorption of the indenter kinetic energy. The processes of dissipation of kinetic energy of the indenter in «Ideal» ceramics are shifted to the elastic region, which provides an increase in the “survivability” of armor protection based on it.

Consequently, «Ideal» ceramic is the most effective and promising material for armor protection.

### References

- [1] *Glass Physics and Chemistry*. **2023**, 49, 539-543
- [2] *Glass Physics and Chemistry*. **2021**, 47, 281–288

### Acknowledgements

This work was supported by the Russian Science Foundation (project No 20-13-00054).

# SYNTHESIS AND STUDY OF PHOTOCATALYTIC AND PIEZOPHOTOCATALYTIC PROPERTIES OF PEROVSKITE-TYPE LAYERED OXIDE $\text{Bi}_3\text{NbTiO}_9$

*Beklemyshev V.E.<sup>1</sup>, Zvereva I.A.<sup>1</sup>,  
Magomedova A.G.<sup>2</sup>, Orudzhev F.F.<sup>2</sup>*

<sup>1</sup> St. Petersburg State University, St. Petersburg, Russia

<sup>2</sup> Dagestan State University, Makhachkala, Russia

Student

[st117562@student.spbu.ru](mailto:st117562@student.spbu.ru)

Photocatalysis is considered to be one of the most promising green and efficient technologies for water purification from toxic water pollutants. Due to this in the 21<sup>st</sup> century the design of photoactive materials to convert solar energy into chemical energy became the one of general direction in the investigations. One of the serious problems which to be solved to increase the efficiency of the photocatalytic destruction of organic pollutants is to suppress the electron-hole recombination. On this way there are several strategies, for example creation of different heterojunctions providing the space separation of carriers widely used [1] but met difficulties of constructing perfect surface on phase boundary in heterostructures.

In the last few years the introducing an external field to reduce carrier recombination and accelerate carrier separation and migration is recognized as an effective approach to enhance the photocatalytic activity [2]. In such case the application of photoactive ferroelectric semiconductors opens the way for the synergistic catalysis – piezophotocatalysis [3,4]. Moreover, if photo-induced process is activated by visual light the photocatalysis provides a sustainable solution to environmental problems.

In this contribution we report results of the investigation of photocatalytic and piezophotocatalytic properties of perovskite-type layered oxide  $\text{Bi}_3\text{NbTiO}_9$  with different morphology in the process of the decomposition of methylene blue as target organic pollutant.

Two samples of  $\text{Bi}_3\text{NbTiO}_9$  have been synthesized by two methods: solid state high temperature synthesis (900°C, 5 h) and molten salt method (800°C, 2 h). In both cases oxides of each metal in stoichiometric ratio have been used as precursors, molten mixture NaCl–KCl has been used as flux. The methods of X-ray phase analysis, scanning electron microscopy, X-ray photoelectron spectroscopy, analysis of specific surface area, diffuse-reflectance spectroscopy were used to characterize the obtained samples. Finally, single phase samples  $\text{Bi}_3\text{NbTiO}_9$  of nanosheet morphology with different regularity and size, slight difference in band gap energy have been obtained.

Photocatalytic activity of as-prepared samples was tested by the degradation of methylene blue under irradiation of xenon lamp using as simulator of solar light. Piezocatalytic activity of the samples was tested under ultrasonic irradiation in the dark. Piezophotocatalytic decomposition of methylene blue has been tested under light and ultrasonic irradiation simultaneously. The control for the degree of the degradation of dye has been carried out by spectrophotometry.

As the results, the differences in the morphology of particles synthesized by different methods are reflected significantly in the photocatalytic properties and has less influence on piezocatalytic and piezophotocatalytic activity. A more noticeable difference in photocatalytic, piezocatalytic and piezophotocatalytic properties has been found for sample  $\text{Bi}_3\text{NbTiO}_9$  with high regular nanosheets, large surface area and smaller porosity. However, for both samples, a synergism enhanced by light and ultrasonic irradiation on catalytic activity is clearly observed.

The research was conducted using the equipment of the Saint Petersburg State University Research Park: Center for X-ray Diffraction Studies, Interdisciplinary Center for Nanotechnology, Center for Optical and Laser Research, Center for Studies in Surface Science, Center for Diagnostics of Functional Materials for Medicine, Pharmacology and Nanoelectronics.

## References

- [1] J. Mater. Sci. Technol. **2024**, 177, 142
- [2] Angew Chem Int Ed Engl. **2021**, 60, 16309
- [3] Applied Surface Science **2024**, 645, 158839
- [4] Applied Surface Science **2024**, 650, 159214

## PHOTOPHARMACOLOGY: EXPLORING THE POTENTIAL OF LUMINESCENT NANOPARTICLES AND PHOTOSWITCHABLE PHOSPHONATES IN DISEASE TREATMENT

*Bikbaeva G.I.<sup>1</sup>, Pilip A.G.<sup>2</sup>, Egorova A.V.<sup>2</sup>, Medvedev V.A.<sup>1</sup>, Kolesnikov I.E.<sup>1</sup>, Pankin D.V.<sup>1</sup>, Mamonova D.V.<sup>1</sup>, Manshina A.A.<sup>1</sup>*

<sup>1</sup>St. Petersburg State University, St. Petersburg, Russia

<sup>2</sup>St. Petersburg Federal Research Center of the Russian Academy of Sciences, St. Petersburg, Russia

Postgraduate

[BikbaevaGI@yandex.ru](mailto:BikbaevaGI@yandex.ru)

Today, photopharmacology is an actively developing field of research. Nowadays, the main players in photopharmacology are «photoswitch-pharmacore» couples that change biological activity due to light irradiation. Photopharmacological agents have shown promising potential in treating a wide range of diseases from oncological to neurodegenerative disorders [1]. However, the main practical problem with the current strategy is the loss of drug activity after introducing a photo switch. In addition, there is no visualization of the impact area. That is why it is necessary to develop new photopharmacological agents that combine three functions: biological activity, the ability to change it under the influence of light, and visualization of the area of impact.

In this study, a unique hybrid compound of rare earth ion nanoparticles LaVO<sub>4</sub>:Eu<sup>3+</sup> and photo-switchable phosphonate was used. It has been shown to inhibit butyrylcholinesterase (BChE), which is a prognostic marker for numerous diseases [2]. The study of the obtained hybrids using luminescence spectroscopy, IR spectroscopy and amperometric analysis of IPC–micro neurotoxins revealed a pronounced effect of laser radiation on the optical and biological properties of new objects. The hybrids demonstrate an increase in butyrylcholinesterase inhibition from 15% to 85%, as well as a simultaneous decrease in luminescence after laser irradiation with a wavelength of 266 nm. All these properties of hybrids have been demonstrated both in vitro and on biological test objects.

### References

- [1] Hüll K., Morstein J., Trauner D. In Vivo Photopharmacology // Chem. Rev. 2018. Vol. 118, № 21. P. 10710–10747.
- [2] I. Kolesnikov, D. Mamonova, D. Pankin, G. Bikbaeva, A. Khokhlova, A. Pilip, A. Egorova, V. Zigel, A. Manshina, Photochemistry and Photobiology. 99(3), 929-935(2023)

### Acknowledgements

This work was supported by the Russian Science Foundation (project No 22-13-00082).

## EFFECT OF GAMMA-RAYS ON RECOMBINATION DYNAMICS AND DEFECT CONCENTRATION IN A WIDE BANDGAP PEROVSKITE

*Boldyreva A. G.<sup>1</sup>, Tepliakova M. M.<sup>1</sup>, Novikov A. V.<sup>1</sup>, Petrov V. G.<sup>2</sup>, Parfenova O.<sup>1</sup>, Vasilev A.<sup>3</sup>, Saranin D.<sup>3</sup>, and Stevenson J.K.<sup>2</sup>*

<sup>1</sup> Center of Energy Science and Technology, Skolkovo Institute of Science and Technology, Bolshoy Boulevard 30, bld. 1, Moscow 121205, Russia

<sup>2</sup> Lomonosov Moscow State University, Department of Chemistry, Leninskie Gory 1 bld. 3, Moscow 119991, Russia

<sup>3</sup> National University of Science and Technology MISiS, Leninskiy Prospekt 4, Moscow 119049, Russia

PhD

[a.boldyreva@skoltech.ru](mailto:a.boldyreva@skoltech.ru)

Complex lead halides with the perovskite structure recently showed surprisingly high resistance towards high-energy electrons, protons, and hard ionization such as X-rays and gamma-rays. Superior radiation hardness makes a family of perovskite semiconductors an attractive candidate for single- and multijunction solar cells for the space environment and as X-ray and gamma-ray detectors.

As the space environment does not contain oxygen and moisture, perovskite solar cells are expected to have a longer operating lifetime, compared to terrestrial applications. What is more dangerous in space is the high level of ionization, which is characterized by the total ionizing dose (TID) parameter [1]. It is estimated, that the accumulated dose can reach 1000 kRad (10 kGy) in 20 years of exploitation [2]. One of the ways to study the radiation hardness of the materials to be used in space is by exposing them to ionization sources such as <sup>60</sup>Co or <sup>137</sup>Cs with photon energies 1.1 MeV and 662 keV respectively.

Herein, we have explored the recombination dynamics and defect concentration of a mixed cation mixed halide perovskite  $\text{Cs}_{0.17}\text{FA}_{0.83}\text{Pb}_{1.8}\text{Br}_{1.2}$  with 1.74 eV bandgap after exposure to a gamma-ray source (2.5 Gy/min). We used photoluminescent spectroscopy to observe changes in recombination dynamics on perovskite films, impedance spectroscopy to reveal the contribution of interface recombination, and admittance spectroscopy to define the activation energy and concentration of defects. It was revealed that moderate doses (up to 10 kGy) passivate defects with activation energy  $\approx 0.5$  eV and at the same time form new defects that cause dramatic growth of the diffusion coefficient and migration of mobile ions. Doses above 10 kGy are detrimental for perovskite solar cells, mainly due to the growing role of interface recombination. The results encourage the use of the wide bandgap perovskite  $\text{Cs}_{0.17}\text{FA}_{0.83}\text{Pb}_{1.8}\text{Br}_{1.2}$  as a material for tandem solar cells with potential applications in a space environment.

### References

- [1] CERN - ESA - SSC workshop. *Cern - ESA - SSC Work.* **2017**  
[2] *Joule* **2022**, 6, 1015–1031

### Acknowledgements

This work was supported by Russian Science Foundation (project No. 23-72-01114)

<sup>1</sup> Novosibirsk State University, Natural Science Department, Novosibirsk, Russia<sup>2</sup> Nikolaev Institute of Inorganic Chemistry, Siberian Branch of Russian Academy of Science, Novosibirsk, Russia

Student

[a.bondareva04@mail.ru](mailto:a.bondareva04@mail.ru)

The search for neutrinoless double beta decay is a unique way to study the properties of neutrinos that go beyond the Standard Model. Neutrinoless double beta decay is a theoretical process proposed for a number of nuclei. One of the highest priority nuclei is <sup>100</sup>Mo, which benefits from high decay energy and natural abundance. Projects such as AMoRE-II [1] and CUPID-Mo [2] use the Li<sub>2</sub>MoO<sub>4</sub> scintillation crystal to study neutrinos in underground laboratories, where space is an important aspect. Therefore, we became interested in the scintillation crystal Na<sub>6</sub>Mo<sub>11</sub>O<sub>36</sub> due to the higher mass content of molybdenum, lack of hygroscopicity and possibly higher light output due to larger density and [MoO<sub>4</sub>]<sup>2-</sup> and [MoO<sub>6</sub>]<sup>2-</sup> polyhedra ratio.

The crystals are grown by the modified Czochralski method, which consists in pulling the crystal out of the melt with a temperature gradient of less than 1 K/cm. It is additionally important when growing compounds with cleavage planes, such as sodium molybdates. This modification was developed by NIIC and assumes a closed system with weight control. The installation diagram is shown in Figure 1, the grown Na<sub>6</sub>Mo<sub>11</sub>O<sub>36</sub> crystal is shown in Figure 2.

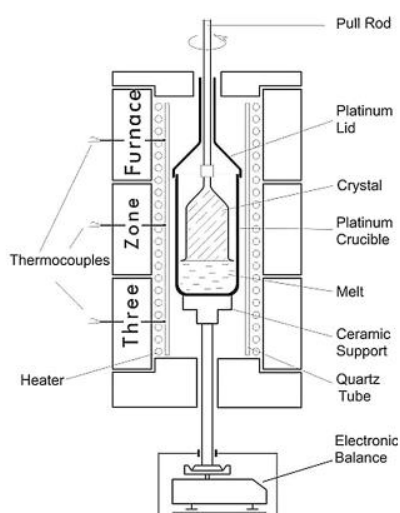

**Figure 1.** Scheme of the low-thermal-gradient Czochralski technique.



**Figure 2.** Na<sub>6</sub>Mo<sub>11</sub>O<sub>36</sub> crystal.

The Na<sub>6</sub>Mo<sub>11</sub>O<sub>36</sub> compound crystallizes in orthorhombic and monoclinic structures. The crystals exhibited dependence of luminescence properties from growth conditions. The crystal has Photoluminescence (PL) at room temperature was registered in sample with monoclinic structure, PL from 225 K in orthorhombic one. In both samples PL intensity increases with decreasing temperature.

### References

- [1] Yoomin Oh, AMoRE-II preparation status, PoS (TAUP2023), **2024**, 441, 214, <https://doi.org/10.22323/1.441.0214>.  
 [2] C. Augier et al., Final results on the  $0\nu\beta\beta$  decay half-life limit of <sup>100</sup>Mo from the CUPID-Mo experiment, Submitted to Eur. Phys. J. C. **2022**, 82, 11, 1-20, <https://doi.org/10.1140/epjc/s10052-022-10942-5>.

### Acknowledgements

This work was supported by the Russian Science Foundation № 23-23-10068 and Novosibirsk Region Grant № p-49 (<https://rscf.ru/project/23-23-10068>).



## PHARMACOKINETIC STUDY OF NANOPARTICLE-BASED PACLITAXEL FORMULATIONS AFTER PRE-TREATMENT WITH RITONAVIR

*Boyko S.A.<sup>1</sup>, Esefiyeva T.Yu.<sup>1</sup>, Kovshova T.S.<sup>1</sup>, Malinovskaya J.A.<sup>1</sup>, Abakumov M.A.<sup>1</sup>, Gelperina S.E.<sup>1</sup>*

<sup>1</sup> Mendeleev University of Chemical Technology of Russia, Moscow, Russia

<sup>2</sup> Pirogov Russian National Research Medical University, Moscow, Russia

Postgraduate

[718bsvetlana@gmail.com](mailto:718bsvetlana@gmail.com)

The blood-tissue barriers in human body considerably limit the efficacy of paclitaxel (PTX), the antitumor agent that is widely used in clinics for the chemotherapy of various cancers. However, the efficacy of PTX against brain cancers is limited by its low penetration across the blood-brain barrier (BBB). Indeed, PTX is the substrate of P-glycoprotein (P-gp), a potent efflux transporter exhibited by the endothelial cells forming the BBB that hampers drug penetration into the brain [1,2]. Obviously, the brain delivery of PTX could be enhanced by employment of the P-gp inhibitor. Ritonavir (RTV), a synthetic antiretroviral drug and a potent inhibitor of P-gp and CYP3a (microsomal liver enzyme), is an interesting candidate for this approach [3]. Thus, penetration of orally administered PTX into the brain, as well as its plasma concentrations, were enhanced when PTX was co-administered with oral RTV. In this case, the enhanced brain uptake could be mainly due to the increase of the plasma concentrations caused by inhibition of the liver enzyme.

The objective of this research was to study the effect of RTV on the plasma pharmacokinetics and penetration of PTX into the rat brain upon intravenous administration of both drugs which could shed light on the role of P-gp. Additionally, we also investigated the uptake of PTX in the testes, another organ protected by the blood-tissue (blood-testis) barrier similar to the BBB.

The study was performed using two colloidal PTX formulations based on human serum albumin nanoparticles (PTX-HSA NP) and poly(lactic-co-glycolic acid) nanoparticles coated with poloxamer P188 (PTX-PLGA NP). The PTX-PLGA NP and PTX-HSA NP (size  $\approx$ 100-150 nm,  $\zeta$ -potential  $\approx$ -20 mV) were obtained by the high-pressure homogenization method followed by the removal of the organic solvent. The water-compatible ritonavir formulation, RTV-HSA NP (size  $\sim$  350 nm,  $\zeta$  potential  $\approx$ -35 mV) was obtained by ultrasonic homogenization.

The study of the pharmacokinetics and organ distribution of the obtained formulations was carried out in male rats; all nanoformulations were administered into the tail vein at the dose of 10 mg/kg body weight. The following groups were tested (36 animals in each group): 1) PTX-PLGA NP; 2) PTX-HSA NP; 3) RTV-HSA NP followed by PTX-PLGA/P188; 4) RTV-HSA NP followed by PTX-HSA NP. In the groups 3 and 4, the RTV-HSA NP were injected i.v. 30 minutes before the PTX formulations.

To determine the drugs' content in the blood plasma and organ tissues (liver, brain, and testicles), the sample preparation technique with a high degree of extraction of PTX and RTV from the matrix and the method of HPLC analysis with mass spectrometric detection were developed.

The developed HPLC-MS method enabled the simultaneous assay of PTX and RTV in all samples at all time points (from 5 min to 48 h; content in plasma from 10 ng/ml, content in organs from 5 ng/mg tissue and above).

The result of the study demonstrated that the preliminary administration of the water-compatible RTV formulation changes the pharmacokinetics and the biodistribution profile of the nanoparticle-based PTX formulations by increasing their exposure in the blood plasma and the organs protected by the blood-tissue barriers. The pharmacokinetic parameters were calculated using the PKSolver 2.0 add-in software.

### References

- [1] *Current Diabetes Reviews* **2012**, *8*, 401
- [2] *Life* **2022**, *12*, 383
- [3] *Eur. J. Cancer* **2020**, *140*, 130

### Acknowledgements

The research was carried out within the state assignment of Ministry of Science and Higher Education of the Russian Federation (project FSSM-2022-0003).

LIGHT-HARVESTING ARTIFICIAL CELLS CONTAINING CYANOBACTERIA FOR CO<sub>2</sub> FIXATION  
AND  
FURTHER METABOLISM MIMICKING

*Boyuan Yang<sup>1</sup>, Shubin Li<sup>1</sup>, Wei Mu<sup>1</sup>, Zhao Wang<sup>1</sup>, Xiaojun Han<sup>1</sup>*

<sup>1</sup>Harbin Institute of Technology, Harbin, China

Graduate student

[hanxiaojun@hit.edu.cn](mailto:hanxiaojun@hit.edu.cn)

The bottom-up constructed artificial cells help to understand the cell working mechanism and provide the evolution clues for organisms. The energy supply and metabolism mimicry are the key issues in the field of artificial cells. Herein we demonstrate an artificial cell containing cyanobacteria capable of light harvesting and carbon dioxide fixation to produce glucose molecules by converting light energy into chemical energy. Two downstream “metabolic” pathways starting from glucose molecules are investigated. One involves enzyme cascade reaction to produce H<sub>2</sub>O<sub>2</sub> (assisted by glucose oxidase) first, followed by converting Amplex red to resorufin (assisted by horseradish peroxidase). The other pathway is more biologically relevant. Glucose molecules are dehydrogenated to transfer hydrogens to NAD<sup>+</sup> for the production of nicotinamide adenine dinucleotide (NADH) molecules in the presence of glucose dehydrogenase. Further, NADH molecules are oxidized into NAD<sup>+</sup> by pyruvate catalyzed by lactate dehydrogenase, meanwhile, lactate is obtained. Therefore, the cascade cycling of NADH/NAD<sup>+</sup> is built. The artificial cells built here pave the way for investigating more complicated energy-supplied metabolism inside artificial cells.

#### **Acknowledgements**

This work was supported by the Russian Science Foundation (project No XXX). This work was supported by the National Natural Science Foundation of China (Grant No. 22174031, 21929401, and 22111540252), the Fundamental Research Funds for the Central Universities (HIT.OCEF.2021026), and the Heilongjiang Touyan Team (HITTY-20190034).

## ENCAPSULATION OF TEA POLYPHENOLS INTO MELAMINE BARBITURATE SUPRAMOLECULAR ASSEMBLY

*Bridenko L.A.<sup>1</sup>, Nishanbaev I. Zh.<sup>1</sup>, Moskalenko I. V.<sup>1</sup>, Skorb E. V.<sup>1</sup>*

<sup>1</sup>ITMO University, St. Petersburg, Russia

Student

[bridenko@infochemistry.ru](mailto:bridenko@infochemistry.ru)

Green tea contains polyphenols such as epicatechins and gallic acid derivatives[1], which are potential antioxidants and anticancer agents. However, isolation of water-soluble polyphenols from tea extracts is challenging.

To improve the stability and bioavailability of polyphenols, encapsulation into supramolecular assemblies capable of controlled release depending on environmental conditions can be utilized. For example, melamine barbiturate (Mel-BA) assemblies based on hydrogen bonds can be used for this purpose [2].

In this study, melamine barbiturate assemblies with green tea extract (Mel-BA-GT) were created and studied. This material was subjected to various techniques such as PXRD, FTIR, EPR, DSC, SEM and fluorescence microscopy. The probability of hydrogen bond formation between polyphenols, melamine and barbituric acid was estimated using quantum chemical calculations.

The amount of encapsulated polyphenols and antioxidant activity were evaluated before and after encapsulation using DPPH test. Microswimmers were also prepared by modifying the particles with hexachloroplatinic acid, which allows them to be used as a delivery system for polyphenols.

### References

- [1] Xing, L.; Zhang, H.; Qi, R.; Tsao, R.; Mine, Y. Recent Advances in the Understanding of the Health Benefits and Molecular Mechanisms Associated with Green Tea Polyphenols. *J. Agric. Food Chem.* 2019, 67 (4), 1029– 1043
- [2] Nesterov, P.V.; Shilovskikh, V.V.; Sokolov, AD; Gurzhiy, V.V.; Novikov, AS; Timralieva, A.A.; Belogub, EV; Kondratyuk, ND; Orekhov, N.D.; Skorb, EV Encapsulation of Rhodamine 6G Dye Molecules for Affecting Symmetry of Supramolecular Crystals of Melamine-Barbiturate. *Symmetry (Basel)*. 2021, 13 (7), 1119.

# MODIFICATION OF NANOTUBULAR NICKEL HYDROSILICATE BY COBALT COMPOUNDS IN SITU AND BY HYDROTHERMAL TREATMENT

*I.D. Bystrevsky<sup>1</sup>, E.N. Gatina<sup>1</sup>*

<sup>1</sup>I.V. Grebenshchikov Institute of Silicate Chemistry of the Russian Academy of Sciences,  
St. Petersburg, Russia  
Postgraduate student  
[bis-ilja2009@yandex.ru](mailto:bis-ilja2009@yandex.ru)

Nickel layered hydrosilicate, due to its ability to form particles with nanotubular morphology, is of considerable interest, both in the context of fundamental research and from the point of view of practical application. In particular, it was used as a composite for supercapacitors [1]. The ability of hydrosilicates to isomorphic substitution of cations, as well as the high specific surface area of the nanotubes themselves, makes it possible to modify them with various substances in order to improve or give them new physico-chemical properties.

The purpose of this work was to study the processes of thermochemical modification of  $\text{Ni}_3\text{Si}_2\text{O}_5(\text{OH})_4$  hydrosilicate nanotubes with cobalt compounds in the process of formation and already synthesized.

The synthesis of the initial and modified hydrosilicates was carried out by the hydrothermal method [2]. The initial nanotubes were processed in solutions of chloride, sulfate and cobalt nitrate at various temperature and time parameters (140-220 °C, 2-24 hours) under hydrothermal conditions. Hydrothermal synthesis was also carried out in the initial mixture with cobalt-containing  $\text{Co}_2\text{O}_3$  and  $\text{Ni}_{0.5}\text{Co}_{0.5}(\text{OH})_2$ , silicon was introduced as nickel metasilicate  $\text{NiSiO}_3$  and  $\text{SiO}_2$  oxide in aqueous solutions of  $\text{NaOH}$  and  $\text{Na}_2\text{SO}_3$ . The obtained powder samples were examined by XRF and SEM methods.

During the work, it was revealed that during hydrothermal treatment of nanotubes with cobalt nitrate solution at temperatures above 180° C for more than 4 hours, the cobalt oxide phase  $\text{Co}_3\text{O}_4$  is formed while preserving the nanotubular phase of the hydrosilicate (component ratio  $\text{Ni}_3\text{Si}_2\text{O}_5(\text{OH})_4:\text{Co}_3\text{O}_4 = 55,5:44,5$  wt%).

When introducing cobalt compounds in situ, the use of  $\text{Na}_2\text{SO}_3$  as a hydrothermal medium prevents the oxidation of cobalt, which was recorded by the Rietveld method [3]. It was found that the composition of the samples represents the phases of nanotubes and cobalt oxide  $\text{CoO}$ . When  $\text{Co}_2\text{O}_3$  was added, the formation of the nepuit phase was recorded.

## References

- [1] Wang Q., Zhang Y., Jiang H., [et al]. ACS Appl. Energy Mater, **2018**, 2(7), P. 3396–3409
- [2] Korytkova E.N., Pivovarova L.N. Glas. Phys. Chem., **2010**, 36(1), 53-60.
- [3] Bubnova R.S. Firsova V.A., Volkov S.N., Filatov S.K. Glas. Phys. Chem., **2018**, 44(1), 48-60

## Acknowledgements

The work was carried out with the support of the Ministry of Education and Science of the Russian Federation within the framework of the state assignment of the ISC RAS (topic № 1023032900322-9-1.4.3).

## MACHINE-LEARNED INTERATOMIC POTENTIAL FOR MODELING ICP CVD

Garifullin K.Z.<sup>2,3</sup>, Mezentsev I.A.<sup>1,4</sup>, Losev T.V.<sup>1,4</sup>, Bashirov I.I.<sup>1,4</sup>, Salimov R.G.<sup>1</sup>, Klikushin A.S.<sup>1</sup>, Podryabinkin E.V.<sup>2</sup>, Malyshev V.I.<sup>1,4</sup>, Chaliy V.A.<sup>1,4</sup>, Novikov I.S.<sup>2,3</sup>, Shapeev A.V.<sup>2</sup>, Medvedev M.G.<sup>1,4</sup>

<sup>1</sup>N.D. Zelinsky Institute of Organic Chemistry of Russian Academy of Sciences, Moscow, Russia

<sup>2</sup>Skolkovo Institute of Science and Technology, Moscow, Russia

<sup>3</sup>Moscow Institute of Physics and Technology, Moscow region, Russia

<sup>4</sup>Center NTI, Bauman Moscow State Technical University Moscow, Russia

Student

[chaliy1303vasiliy@gmail.com](mailto:chaliy1303vasiliy@gmail.com)

Next generation nanoelectronics requires development of new thermally and mechanically stable materials with relative permittivity ( $k$ ) as close to 1 as possible. In June 2020, Hong et al. presented ICP-CVD-deposited amorphous boron nitride (a-BN) with very low  $k$  of 1.78 [1]. This a-BN also turned out to be thermally, chemically, and mechanically stable, and having high breakdown voltage, thus fulfilling all requirements for practical applications. A three-nanometer thick layer of this material was obtained by low-temperature remote inductively coupled plasma–chemical vapor deposition (ICP-CVD) with borazine as the precursor. Two years later Lin et al. conducted seemingly identical synthesis but obtained a compound with noticeably different properties [2]. When synthesis conditions were identical (based on the information in the article) to those of the Hong experiment, the boron to nitrogen ratio (B:N) was  $\sim 2.64$ , whereas the B:N in the original article films was 1.0. To obtain the same B:N, Lin’s team had to explicitly add nitrogen molecules to the gas flow. To understand why supposedly equivalent conditions, lead to different products we have constructed a digital twin of this system to comprehensively reconstruct the ICP-CVD process, encompassing all its intricate details and established the most likely reason for the discrepancy between Hong’s and Lin’s experiments. Our comprehensive model utilizes an active-learning interatomic potential known as MLIP [3]. The designed workflow allowed us to establish, that the films morphology heavily depend on the particles reaching the substrate. This approach not only unveils hidden process dependencies but also establishes a versatile framework for computational modeling.

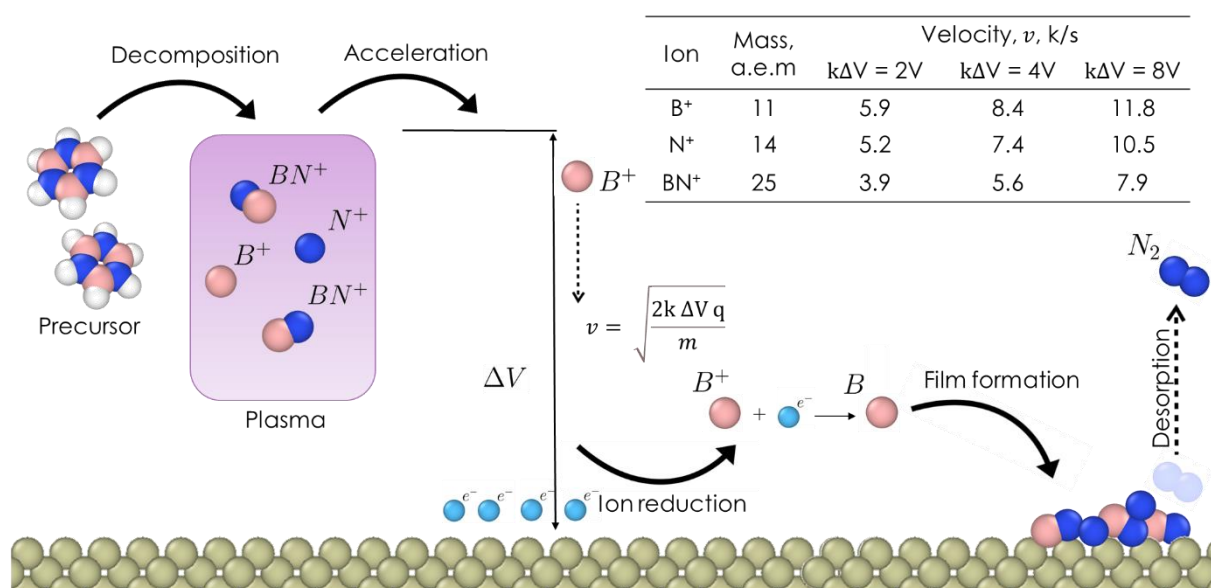

**Figure 1.** Algorithm of computational modeling of ICP-CVD BN film deposition.

### References

- [1] Nature **2020**, 582, 511
- [2] Advanced Materials Technologies **2022**, 7, 2200022.
- [3] Computational Materials Science **2017**, 140, 171

# REVERSIBLE DEFORMATION OF ARTIFICIAL CELL COLONIES TRIGGERED BY ACTIN POLYMERIZATION FOR MUSCLE BEHAVIOR MIMICRY

*Chao Li<sup>1</sup>, Xiaojun Han<sup>1</sup>*

<sup>1</sup>Harbin Institute of Technology, Harbin, China  
[lichao91@hit.edu.cn](mailto:lichao91@hit.edu.cn)

Muscle tissues, made up of numerous muscle cells, are responsible for controlling body movement and the activity of internal organs through their ability to contract. Mimicking these tissues using artificial cells assembled from the bottom-up is advantageous for understanding the interaction mechanisms among cells and collective tissue behaviors, and it holds significant potential in the field of bioinspired medical tissue engineering. The development of self-powered artificial muscle tissues using artificial cells as the building blocks is still in its infancy, and it is challenging to achieve structural isotropy and synchronized cell contraction functions in the constructed tissues.

We have developed self-powered artificial cells capable of reversible deformation by encapsulating living mitochondria, actin proteins, and methylcellulose[1]. The addition of pyruvate molecules prompts the mitochondria to produce ATP molecules, which serve as an energy source to initiate the polymerization of actin. This process results in the artificial cells changing shape from spherical to spindle due to the formation of actin filaments next to the lipid bilayer. Upon laser irradiation, the actin filaments depolymerize, causing the cells to revert to their spherical shape, thus completing the reversible deformation process. Linear colonies of these artificial cells, when stimulated with pyruvate, exhibit collective contraction and relaxation behaviors, mimicking the functions of muscle tissues. During peak contraction, each artificial cell in the colony aligns its long axis parallel to others, synchronizing the contraction phase. The deformation of each cell in the colony is also influenced by adjacent cells. The creation of these muscle-like artificial cell colonies has opened new avenues for developing sustainably self-powered artificial tissues in tissue engineering.

## References

[1] Li, C., Zhang, X., Yang, B., et al. Reversible Deformation of Artificial Cell Colonies Triggered by Actin Polymerization for Muscle Behavior Mimicry. *Adv. Mater.* 2022, 34, 2204039

# INVESTIGATION OF PHOTODEPOSITED PLATINUM LOCALIZATION AT THE LAYERED OXIDES $\text{HCa}_2\text{Nb}_3\text{O}_{10}$ , $\text{H}_2\text{La}_2\text{Ti}_3\text{O}_{10}$ AND THEIR ORGANO-INORGANIC HYBRIDS

*Davydov N.A.<sup>1</sup>, Gubanova A.N.<sup>1</sup>, Silyukov O.I.<sup>1</sup>, Rodionov I.A*

<sup>1</sup> St. Petersburg State University, St. Petersburg, Russia  
[nikita.davidov02@yandex.ru](mailto:nikita.davidov02@yandex.ru)

In recent years, environmental problems caused by using fossil fuel have become particularly acute. Hydrogen produced by the photocatalytic splitting of water and organic substrates under the action of sunlight can be a promising replacement for hydrocarbon fuel. Of particular interest among heterogeneous photocatalysts is a class of layered perovskite-like oxides, in the structure of which there is an alternation of negatively charged perovskite blocks with blocks of a different structure, called interlayer space, which can act as a separate reaction zone in the photocatalytic process [1]. The introduction of organic molecules, for example amines, into interlayer space contributes to an increase in the photocatalytic activity of samples in the reaction of obtaining hydrogen from a 1% (mol.) aqueous solution of methanol under the action of ultraviolet irradiation [2]. In this case, samples additionally modified with photo-deposited platinum particles exhibit particularly high activity. It was assumed that this effect is caused by the expansion of the interlayer space, which led to an increase in the accessibility of this zone for water and methanol molecules. The organic components undergo various transformations due to irradiation with ultraviolet light [3]. At the same time the activity of the photocatalyst remains constant throughout the experiment. A possible reason for the immutability of the activity of organo-inorganic hybrids may also be the deposition of platinum particles in the interlayer space expanded by the introduction of organic matter. In this instance, the activity of the samples would be preserved even after the decomposition of the organic modifiers.

This work focuses on the study of the effect of organic modifiers on the process of photo-deposition of platinum particles and the relationship of this process with the observed photocatalytic activity of hybrid samples of the layered oxides  $\text{HCa}_2\text{Nb}_3\text{O}_{10}$  and  $\text{H}_2\text{La}_2\text{Ti}_3\text{O}_{10}$ . It was found that the sequence of procedures for modifying layered oxide  $\text{H}_2\text{La}_2\text{Ti}_3\text{O}_{10}$  by intercalation of alkylamines  $\text{RNH}_2$  ( $\text{R} = \text{Me}, \text{Oc}$ ) and platination significantly affects the stability of the formed platinum particles to the action of aqua regia. The photocatalytic activity of organic platinized derivatives in the reaction of hydrogen extraction from a 1% (mol.) aqueous methanol solution under UV irradiation was also compared. It was shown that all modified samples exceed the initial  $\text{H}_2\text{La}_2\text{Ti}_3\text{O}_{10}/\text{Pt}$  in terms of photocatalytic activity by 3 times or more, but they did not differ so markedly from each other. As the result it was found that intercalation of organic molecules can affect the deposition of platinum particles in layered oxide. At the same time, the stable photocatalytic activity of the samples is not due to the different spatial distribution of Pt nanoparticles. Thus, the increased activity of photocatalysts is rather associated with the modification of oxides by organic molecules.

## References

- [1] *Russian Chem. Reviews* **2016**, 85, 3, 248-279
- [2] *Catalysts* **2022**, 12, 1556
- [3] *J. Phys. Chem.* **1991**, 95, 1345-1348

## Acknowledgements

The work was supported by Russian Science Foundation (grant №22-73-10110). Authors are also grateful to Saint Petersburg State University Research Park: Centre for X-ray Diffraction Studies, Centre for Optical and Laser Materials Research, Centre for Chemical Analysis and Materials Research, Centre for Thermal Analysis and Calorimetry, Centre for Nanotechnology, Centre for Innovative Technologies of Composite Nanomaterials, Centre for Diagnostics of Functional Materials for Medicine, Pharmacology and Nanoelectronics.

APPLICATION OF CONVOLUTIONAL NEURAL NETWORKS FOR PROCESSING  
OF MÖESSBAUER SPECTROSCOPY DATA

*Deev V.A.<sup>1</sup>, Panchuk V.V.<sup>1</sup>, Kirsanov D.O.<sup>1</sup>*

<sup>1</sup> St. Petersburg State University, St. Petersburg, Russia  
PhD student  
[hitcherv@mail.ru](mailto:hitcherv@mail.ru)

In recent years, there has been a significant increase in the interest of researchers in the application of machine learning methods in solving problems in the field of analytical chemistry. This trend is due to the increasing availability of computer technology and the increasing complexity of instrumental analysis methods. The use of artificial neural networks allows extracting information from measurement results even in case of low resolution and strong overlap of analytical signals, it also allows solving sample classification problems, finding hidden patterns in the data. Such advantages can be very useful in processing of Moessbauer spectroscopy data, where there are currently no fully automated methods for processing spectra, due to the complexity of their interpretation.

The purpose of this work is to apply the method of convolutional neural networks (CNN) to determine the parameters of multiplets in images of Moessbauer spectra.

Unlike the methods described in the literature for using CNN in processing spectral data, in this work each spectrum is considered as an image, and not as a numerical vector. To create models and select architecture of CNN, a simulated data set of 14406 spectra of two doublets of 400 points each was used. The spectra were modelled as a superposition of four Lorentzians (two Lorentz lines for each doublet) as it is in real data. The data differed in the values of isomeric shift (-1 to +3 mm/s, 0.5 mm/s pitch) and quadrupole split (0.2 to 2.7 mm/s, 0.5 mm/s pitch), as well as relative signal intensity (0.1 to 0.9, 0.2 pitch). To build a one-dimensional convolutional neural network, spectral data representing a vector was used (for comparison with the approach described in the literature), and for a two-dimensional one, images of 50 by 50 and 200 by 200 pixels in gray scale .bmp file format were used. The models were employed to predict the characteristics of doublets in 10 real spectra of perovskite-like compounds in  $\text{Bi}_2\text{O}_3\text{-TiO}_2\text{-Fe}_2\text{O}_3$  system.

It was found that the proposed CNN architecture allows achieving satisfactory results in the automatic processing of the Moessbauer spectra of perovskite-like compounds. The increased noise level and the presence of sextet signals in real data, contrary to expectations, did not have a noticeable effect on the accuracy of predicting the isomer shift and quadrupole split of two doublets. Automatic and manual determination of studied parameters lead to equal results. The use of a simpler one-dimensional convolution turned out to be ineffective in the transition from artificially generated data to real spectra, thus indicating a greater influence of the described interfering factors on this variant of processing Moessbauer spectra. At the same time, the use of one-dimensional CNN has shown greater accuracy in determining the relative peak area of doublets compare with two-dimensional CNN.



# THE ROLE OF THE SHELL IN HYBRID MOLECULAR-PLASMONIC NANOSTRUCTURES

*Del Carpio Rocha A.<sup>1</sup>, Soldatova D.A.<sup>1,2</sup>*

<sup>1</sup> St. Petersburg State University, St. Petersburg, Russia

<sup>2</sup> Peter the Great St.Petersburg Polytechnic University, St. Petersburg, Russia

Student

[st116159@student.spbu.ru](mailto:st116159@student.spbu.ru)

The formation of a hybrid molecular-plasmon structures based on gold nanoparticles can be used to enhance the optical properties of porphyrin molecules. This effect is called metal-enhanced fluorescence. On the other hand, the effect of quenching the emission of a fluorophore located on a metal surface is well known. To avoid quenching of porphyrin luminescence by the metal core, it is necessary to ensure that the molecules are distant from the metal surface [1]. To fulfill this condition, a spacer, which will be applied to the core as a shell, can be used. Biopolymer and silica glass shells are widely used for this matter [2]. As a result, the optical properties of the dye can be controlled not only by forming a hybrid structure, but also by changing the thickness of the shell.

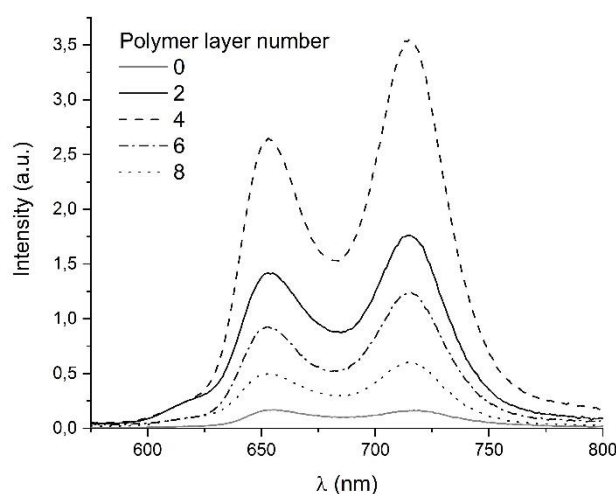

**Scheme 1.** Fluorescence spectra of porphyrin in the composition of hybrid nanostructures depending on the number of layers of the polymer shell

There are different methods for synthesizing shells. For example, the layer-by-layer method involves the sequential application of two polymers with different surface charges. In this case, the distance between porphyrin molecules and surface of gold particles can be controlled by changing the number of polymer layers, while one layer is approximately 0.5 nm. Nonlinear dependence of the porphyrin optical properties on the thickness of the shell was found. The maximum fluorescence signal was observed at the optimal thickness of the spacer.

## References

- [1] *Dye. Pigment.* **2021**, 190, 109263.
- [2] *IEEE Transactions on Nanobioscience.* **2007**, 6(4), 298.

## Acknowledgements

The authors acknowledge Saint-Petersburg State University for a research project 122040800256-8.

# GENERATION OF A SENSOR SIGNAL TO REDUCING GASES IN NANOCRYSTALLINE $\text{SnO}_2$ , SYNTHESIZED BY PEROXIDE-ASSISTED SOL-GEL METHOD

*Dobrovolskii A.A.*<sup>1,2</sup>, *Mikhaylov A.A.*<sup>2</sup>, *Platonov V.B.*<sup>1</sup>, *Rumyantseva M.N.*<sup>1</sup>, *Prikhodchenko P.V.*<sup>2</sup>

<sup>1</sup> Moscow State University, Moscow, Russia

<sup>2</sup> Kurnakov Institute of General and Inorganic Chemistry of the Russian Academy of Sciences, Moscow, Russia

PhD student

[andrالدobr@mail.ru](mailto:andrالدobr@mail.ru)

Peroxide-assisted sol-gel method of metal oxide synthesis is a novel method for producing semiconductor nanocrystalline materials from aqueous hydrogen peroxide solutions of oligomeric sols of hydroperoxocomplexes. As a result of their deposition and subsequent decomposition during heat treatment, nanocrystalline oxides with a complex of microstructural characteristics (small average crystallite size comparable to doubled Debye radius; high specific surface area) optimal for use in gas sensors are obtained.

In this work, 3D and quasi-2D (first time using graphene oxide as a substrate)  $\text{SnO}_2$  samples were obtained from ammonium hydroperoxostannate sol by annealing for 24 hours at 300 and 500 °C. Reference samples were obtained by annealing of  $\beta\text{-SnO}_2 \cdot x\text{H}_2\text{O}$  at same temperatures. Different morphology of the obtained materials was confirmed by SEM images. For 3D  $\text{SnO}_2$ , increasing in the value of CSR (XRD) and decreasing in the specific surface area determined by the nitrogen low temperature adsorption method (BET model) were observed with raising in the synthesis temperature. For 2D  $\text{SnO}_2$ , these parameters did not depend on the long-time annealing temperature. Raman spectroscopy and TPR  $\text{H}_2$  methods revealed oxygen deficiency in 3D  $\text{SnO}_2$  synthesized at 300 °C. With an increase in the synthesis temperature, the lack of oxygen decreased. In case of 2D  $\text{SnO}_2$ , the oxygen content practically corresponded to the stoichiometric one.

2D  $\text{SnO}_2$  synthesized at 300 °C ( $\text{SnO}_2\text{-2D-300}$ ) had practically no sensory response to CO (fig. 1. left). It may be related with absence of oxygen deficiency and vacancies necessary for the adsorption of oxygen from the atmosphere, which is involved in the further oxidation of CO at temperatures of 100-300 °C. The maximum value of the sensor signal for 3D  $\text{SnO}_2$  ( $\text{SnO}_2\text{-3D-300}$ ) corresponded to a temperature of 240 °C. For 3D  $\text{SnO}_2$  synthesized at 500 °C ( $\text{SnO}_2\text{-3D-500}$ ), the sensor signal in the range of 100-300 °C was practically not detected, which may be due to both a decrease in oxygen deficiency and a decrease in the specific surface area. The maximum of sensor signal for all  $\text{SnO}_2$  samples obtained at 500 °C was observed at a temperature of 400 °C. For  $\text{SnO}_2\text{-2D-500}$  value of sensor signal at 400 °C was the same as for 3D  $\text{SnO}_2$  synthesized by the peroxide method. These facts may indicate a change in the main process of formation of the sensory response to CO from oxidation by chemisorbed oxygen to vacancy model, which involves oxidation by oxygen of the  $\text{SnO}_2$  crystalline structure. In this case, in contrast to the low-temperature range, the absence of chemisorbed oxygen on the surface of 2D  $\text{SnO}_2$  does not affect its sensory properties. Both samples (2D and 3D) synthesized with peroxide-assisted sol-gel method at 500 °C showed greater sensor signal to CO at 400 °C compared to  $\text{SnO}_2\text{-ref-500}$  as well as sample  $\text{SnO}_2\text{-3D-300}$  was better than  $\text{SnO}_2\text{-ref-300}$  at 240 °C. Same patterns for all obtained materials were observed for the  $\text{NH}_3$  (fig. 1, center). Inversion of sensor signal in the middle temperatures range (250-350 °C) may be related to complex processes which include changing of predominating species of chemisorbed oxygen ( $\text{O}_2^-$  to  $\text{O}^-$ ) and  $\text{NH}_3$  partial oxidation to NO by more reactive  $\text{O}^-$ . In case of acetone no low-temperature maximum of sensor signal for  $\text{SnO}_2$  sensors synthesized at 300 °C was not observed. It may be related with the stability of acetone and necessity in more reactive  $\text{O}^-$  chemisorbed species for its oxidation as well as with participation in process of the surface oxygen atoms of  $\text{SnO}_2$  structure.

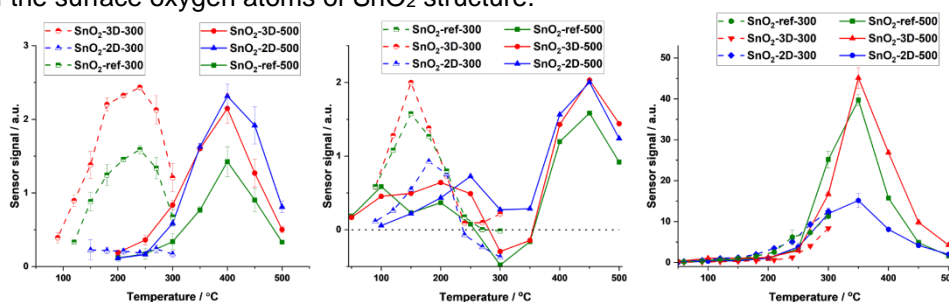

**Figure 1.** Sensor signals for different reducing gases CO (left),  $\text{NH}_3$  (center), acetone (right)

## COMPARISON OF PHOTOCATALYTIC PROPERTIES OF $\text{CoFe}_2\text{O}_4$ , $\text{MgFe}_2\text{O}_4$ AND $\text{Co}_{0.5}\text{Mg}_{0.5}\text{O}_4$

*Doroshenko A.V.<sup>1</sup>, Tomina E.V.<sup>2</sup>, Jujukin K.V.<sup>2</sup>*

<sup>1</sup> Voronezh State University, Voronezh, Russia

<sup>2</sup> Voronezh state forest engineering university named after G.F. Morozov, Voronezh, Russia  
Student

[al.doroschencko2016@yandex.ru](mailto:al.doroschencko2016@yandex.ru)

Pollution of natural water by untreated wastewater from agricultural and industrial production is one of the main anthropogenic impacts on the environment. Organic dyes such as 2,4-dinitrophenol are the main pollutants, they have complex molecular structures that make them chemically and thermally resistant. They are also toxic and carcinogenic, and their presence in water harms living organisms [1-2].

One of the reliable methods of wastewater decolonization is the complete decomposition of the toxicant in the process of deep oxidation. The advantage of phenol-like oxidation is its efficiency. The high percentage of destruction is due to the high activity of hydroxyl radicals [3-4].

Spinel-structured ferrite nanoparticles with the general formula  $\text{MeFe}_2\text{O}_4$  are promising catalysts in fenton-like reactions due to a number of properties: the possibility of easy separation of the used catalyst by a magnetic field, a large number of catalytic active centers, simplicity of synthesis methods and low cost [5].

The synthesis of cobalt ferrite, magnesium ferrite and cobalt-magnesium ferrite by the method was carried out by the citrate combustion method [6].

The photocatalytic properties of heterogeneous catalysts  $\text{CoFe}_2\text{O}_4$ ,  $\text{MgFe}_2\text{O}_4$  and  $\text{Co}_{0.5}\text{Mg}_{0.5}\text{O}_4$  were studied using a model reaction of DNP oxidation with hydrogen peroxide. The dye concentration was measured using a photocolimeter "KFK-3-01 "3OM3". The irradiation was performed using a UVb UVC-E27, 20W UV lamp and a LightBest UVC-E27, 25W UV lamp.

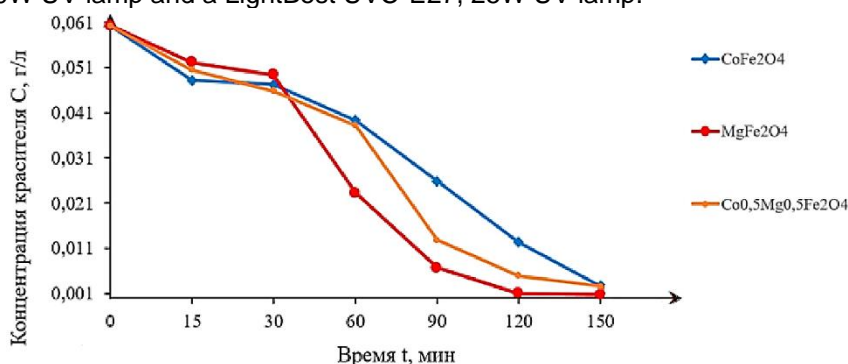

**Scheme 1.** Kinetic curves of the DNF oxidation reaction under UV irradiation.

The photocatalytic activity of nanoscale  $\text{MgFe}_2\text{O}_4$  in the process of phenon-like oxidative degradation of DNF is higher than that of  $\text{CoFe}_2\text{O}_4$  and  $\text{Co}_{0.5}\text{Mg}_{0.5}\text{O}_4$  nanopowders. The degree of destruction of the dye in the presence of cobalt ferrite after 2.5 hours was about 95.5%, in the presence of cobalt–magnesium ferrite – 95.8%, and in the presence of magnesium ferrite - 98.8%.

### References

- [1] Advances in Colloid and Interface Science **2021**, 294, 102486
- [2] Applied Surface Science Advances **2021**, 6, 100145
- [3] Materials Today: Proceedings **2022**, 34, 104576
- [4] Journal of Alloys and Compound **2022**, 896, 162966
- [5] News of universities. The North Caucasus region. Technical sciences **2019**, 3, 59
- [6] Inorganic Materials **2022**, 58, 703

### Acknowledgements

This work was supported by the Russian Science Foundation (project No 23-23-00122).

## ZIF-8 MEMBRANE FOR THE EXTRACTION OF LITHIUM

*Doroshenko I.V.<sup>1</sup>, Dmitrieva M.A.<sup>1</sup>, Filippova I.S.<sup>1</sup>, Krivoshapkina E.F.<sup>1</sup>*

<sup>1</sup> ITMO university, ChemBio cluster, SCAMT institute, St. Petersburg, Russia  
Student, 1 year of master's degree  
[doroshenko@scamt-itmo.ru](mailto:doroshenko@scamt-itmo.ru)

The demand for lithium, known as the "Energy Metal in the 21st Century" [1], is continuously growing due to the increased usage of electric-powered vehicles and advanced electronics operating on lithium-ion batteries. Global lithium demand is increasing significantly, and it is expected to become scarce. That is the main reason for an emphasis to be made on recapturing waste and converting it into a raw material, increasing the metal's availability and making lithium production more sustainable. Direct lithium extraction technologies show a potential in increasing the supply of lithium from water projects, including operations with enriched by lithium waste waters of oil and gas condensate fields.

The idea of the project is to extract lithium with the membrane technology, using this membrane as an extractor module. Technology will allow oil producing companies to get additional profit from the waters of oil and gas condensate fields.

The composite membrane is based on cellulose acetate and is modified with a metal-organic framework zeolitic imidazolate framework-8 (ZIF-8). Cellulose acetate (CA) can be described as an affordable carrier material for metal-organic framework structures with a good stability during the metal-extraction process [2]. A choice of ZIF-8 for ion-selective separation was made due to its homogeneous porosity, specific size characteristics, and substantial surface areas, allowing this framework to be highly suitable for lithium recovery applications [3].

We used inkjet printer to get a uniform ZIF-8 layer on the membrane (ZIF-8 particle size was 132 nm). Figure 1 represents Scanning electron microscopy (SEM) and Energy-dispersive X-ray spectroscopy (EDX) results of the membrane analysis. Results indicate the successful synthesis process, demonstrating the presence of ZIF-8 on the surface of the membrane.

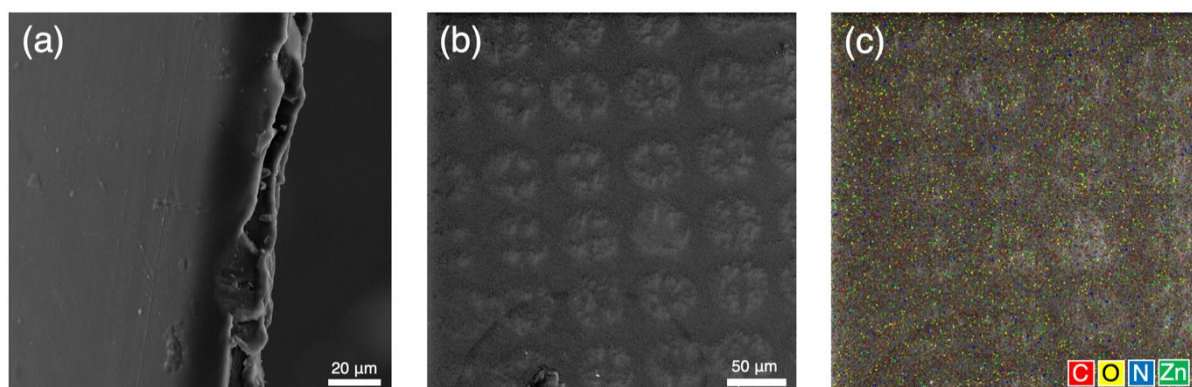

**Figure 1.** (a) SEM for CA; (b) SEM for CA with a ZIF-8 layer; (c) EDX for CA with a ZIF-8 layer

A comprehensive analysis of lithium extraction methods was conducted, and the results of this analysis led the research towards choosing the ion-selective membrane as the most promising technology for lithium extraction from oilfield waters. Afterwards, the most practically-applicable modifications of the membrane have been researched.

### References

- [1] Garcia L. V. et al., "Lithium in a Sustainable Circular Economy: A Comprehensive Review," *Processes*, vol. 11, no. 2, p. 418, Jan. 2023.
- [2] Paredes C. et al., "Selective lithium extraction and concentration from diluted alkaline aqueous media by a polymer inclusion membrane and application to seawater," *Desalination*, vol. 487, p. 114500, Aug. 2020.
- [3] Yu H. et al., "Selective lithium extraction from diluted binary solutions using MOF-based membrane capacitive deionization," *Desalination*, vol. 556, p. 116569, Jun. 2023.

### Acknowledgements

The Priority 2030 Federal Academic Leadership Program for infrastructural support.

## ELECTROANALYTICAL SYSTEM FOR DIRECT H<sub>2</sub>O<sub>2</sub> DETECTION IN EXHALED AEROSOL

*Dubov L.A., Karyakin A.A., Komkova M.A*

Lomonosov Moscow State University, Moscow, Russia

Student, 3<sup>rd</sup> Year Bachelor

[leo.dubov@gmail.com](mailto:leo.dubov@gmail.com)

Non-invasive diagnostic is a promising strategy of modern medicine. One of important objects of non-invasive diagnostics is exhaled breath condensate (EBC), which contains a plenty of markers including H<sub>2</sub>O<sub>2</sub>. Monitoring H<sub>2</sub>O<sub>2</sub> concentration, one can trace the course of pulmonary diseases. In medical practice, collection of exhaled breath condensate with extreme cooling (up to -78°C) during up to 30 minutes is generally used/ It results in dilution of the condensate samples with water vapor which obviously leads to a decrease in metabolite concentrations. The aim of this work is to develop a sensor system for analyzing aerosol at the moment of exhalation without additional cooling.

The suggested system is based on electrochemical sensors with Prussian blue (PB) as the most selective and sensitive H<sub>2</sub>O<sub>2</sub> transducer. To condense the exhaled aerosol onto the sensor surface, it is covered with a layer of solid hygroscopic electrolyte and a membrane based on aminated graphene oxide (GO). In humid air conditions, GO captures and accumulates aerosol through capillary condensation, providing ionic conductivity between the electrodes. According to cyclic voltammetry data, the maximum electroactivity of PB is achieved within 15 seconds of aerosol passing, reducing the distance between cathodic and anodic peaks from 0.3–0.4 V to 50–150 mV.

In the developed sensor system, the amperometric response at 0 V relative to a silver chloride reference electrode was considered as the analytical signal. The peak current dependence linearly correlates with the rate of the analyzed aerosol flow, saturating at the values above 100 ml/s, which corresponds to a typical flow rate generated during calm human breathing. It indicates potential applicability of the system for the aerosol analysis at the moment of exhalation. The linear range of detected H<sub>2</sub>O<sub>2</sub> contents in the aerosol is determined by the potential step: at a potential step of 0.7 V – from 0.05 μM to 0.5 μM, 0.65 V – from 1 μM to 15 μM, 0.6 V – from 5 μM to 20 μM. Thus, by adjusting the potential step, one can tune the working range of the system.

The developed system was tested for the analysis of aerosol exhaled by healthy volunteers and smokers. For independent analysis of H<sub>2</sub>O<sub>2</sub> concentration in aerosol by a spectrophotometric assay using peroxidase, exhaled microdroplets were accumulated in a system of turbulent flows. It was shown that the peak current recorded by the developed system correlates with the reference values. According to spectrophotometric detection, H<sub>2</sub>O<sub>2</sub> concentrations in exhaled aerosol range from 0.5 to 10 μM, with two different trend lines for smokers and healthy volunteers. Therefore, the developed system has the potential to be used for non-invasive express monitoring of inflammatory processes in the lungs.

### References

[1] *Curr. Opin. Electrochem.* **2017**, 5.

### Acknowledgements

This work was supported by the Russian Science Foundation (project No 24-73-10015).

# STUDY OF THE PHYSICAL AND MECHANICAL CHARACTERISTICS OF «IDEAL» CERAMICS (DIAMOND - SILICON CARBIDE COMPOSITE)

Dyuskina D.A.<sup>1</sup>

<sup>1</sup> National Research Centre “Kurchatov Institute”, Gorynin Central Research Institute of Structural Materials “Prometey”, St. Petersburg, Russia

Graduate student  
[randkald@mail.ru](mailto:randkald@mail.ru)

Composite materials based on diamond particles are of great interest for various applications due to a combination of properties such as low density and thermal expansion coefficient, high hardness, speed of sound and thermal conductivity, increased wear resistance, etc.

In this work, a diamond-silicon carbide composite material (“Ideal” ceramic) was synthesized from diamond powders of different fractions (20–28  $\mu\text{m}$  and 225–250  $\mu\text{m}$  in the ratio 30%/70%, respectively). The technology for producing this ceramic is described in detail in [1].

During the process of reaction sintering in accordance with the reaction-diffusion Turing mechanism, under certain conditions, the growth of silicon carbide grains on diamond particles is observed, forming triply periodic surfaces, which increases the properties of Ideal ceramics. Dense layers of SiC fill all the spaces between the diamonds and form a monolithic material.

The physical, mechanical and elastic properties of “Ideal” ceramics have been studied. Figure 1 shows the calculated data for the relative penetration coefficient of the striker “K” (Shevchenko criterion [2]) and the Ashby criterion “M”, which allows you to evaluate different materials used for armor protection [3].

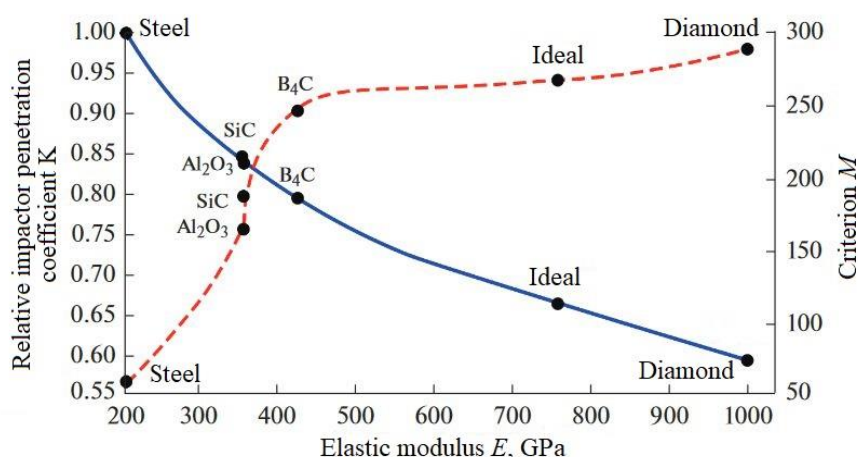

**Figure 1.** Dependence of the coefficient of relative penetration of a steel striker into ceramics “K” (solid line) and the Ashby criterion “M” (dashed line) on the elastic modulus for different materials.

Analysis of the curves of the relative penetration coefficient of the striker “K” and the criterion “M” shows that the determining factors for assessing the resistance of various materials, including ceramics, to dynamic loading are the speed of sound and the elastic modulus of the material, which makes it possible to explain and study the propagation of shock waves in ceramics. Ceramics “Ideal” is characterized by the best properties of existing armor materials.

## References

- [1] *Russian Journal of Inorganic Chemistry* **2021**, 66. 8. 1107.
- [2] *Glass Physics and Chemistry* **2021**, 47. 4. 281.
- [3] *Glass Physics and Chemistry* **2023**, 49. 6. 539.

## Acknowledgements

This work was supported by the Russian Science Foundation (project No 21-73-30019).

# BI-SOLVENT ENGINEERING METHOD FOR IMPROVING THE EFFICIENCY AND STABILITY OF A WIDE-BANDGAP PEROVSKITE

*Dzhouse-Ivanina S.A.<sup>1</sup>, Parfenova O.R.<sup>1</sup>*

<sup>1</sup> Skolkovo Institute of Science and Technology, Moscow, Russia

Student

[sdzhouseivanina@gmail.com](mailto:sdzhouseivanina@gmail.com)

Double-junction solar cells with increased theoretical power conversion efficiency (PCE) show great potential for application in photovoltaic (PV) systems, among which the perovskite/silicon tandem solar cells have been highlighted due to existing industrial advantages of their bottom cells [1]. Perovskite absorbers in such cells should have bandgaps exceeding 1.7 eV to ensure complimentary absorbance with Si sub-cell. Therefore commercialization of this technology requires the development of wide-bandgap (WBG) perovskites [2]. Stability and efficiency of the perovskite material depend on the quality of the perovskite film, which can be affected by the parameters of the fabrication technology. Solution-based processing of perovskite films dictates the application of solvent engineering method for production of perovskite materials with improved characteristics.

In present work we improve the efficiency and intrinsic stability of a  $\text{Cs}_{0.17}(\text{CH}_3\text{N}_2)_{0.83}\text{PbI}_{1.8}\text{Br}_{1.2}$  WBG perovskite ( $E_g = 1.75$  eV) by solvent engineering approach. Two solvents for the perovskite precursor solution: dimethyl sulfoxide (DMSO) and *N,N*-dimethylformamide (DMF) are mixed to facilitate the formation of a perovskite material with increased thickness and grain size and decreased defect density. The change in crystallization dynamics granted by the use of such bi-solvent system leads to the formation of a specific surface which improves the light management properties. As a result, the degradation rate after 2000 hours of sun exposure is decreased, and the average PCE of solar cells is increased by 1.2%.

## References

- [1] *Nat Energy* **2018**, 3, 828
- [2] *Semicond. Sci. Technol.* **2019**, 34, 093001

## Acknowledgements

This work was supported by the Russian Science Foundation (project No 23-72-01114).

## RECYCLING OF ASPHALTENE SEDIMENTS IN A PLASMA REACTOR AT DIFFERENT DISCHARGE INITIATION TIMES

V.V. Egorova <sup>1</sup>, P.V. Povalyaev <sup>1,2</sup>, E.V. Frantsina <sup>1,2</sup>, Yu.Yu. Petrova <sup>1</sup>

<sup>1</sup>Surgut State University, Surgut, Russia

<sup>2</sup>Tomsk Polytechnic University, Tomsk, Russia

Graduate student, Junior Research Associate SurGU

[arkachenkova\\_vv@surgu.ru](mailto:arkachenkova_vv@surgu.ru)

The accumulation of residues and wastes of the oil industry leads to the problem of increased environmental risks and the necessity to find ways of their rational processing and/or disposal. These circumstances suggest a shift to non-carbon energy sources and reduction carbon footprint in the oil industry. One of the promising methods for the synthesis of carbon materials from wastes of oil industry is plasma treatment under the action of direct current arc discharge.

The purpose of this study is to investigate the possibility of obtaining carbon materials by recycling oil industry waste.

The subject of the study was asphaltene sediments (AS) collected from the oil well. The AS studied belongs to the paraffin type of deposits ( $\beta=0.418$ ), the content of mechanical impurities is 0.92 wt. %.

According to the results of X-ray fluorescence analysis (EDX-7000, Shimadzu), the main element in the AS molecule is carbon (99.5 wt. %). The presence of other trace elements (sulfur, iron, chlorine, et. al.) is due to the conditions of AS formation. According to the results of IR spectroscopy carried out on the ATR prefix (Spectrum 100 Series, Perkin Elmer), the AS contains bands of stretching (3010-2750  $\text{cm}^{-1}$ ) and bending (1490-1350  $\text{cm}^{-1}$ ) vibrations of branched fragments  $-\text{CH}$ ,  $-\text{CH}_2$ ,  $-\text{CH}_3$ , as well as bending vibrations of carbon-carbon bonds (730-710  $\text{cm}^{-1}$ ). The presence of these fragments is due to the high content of paraffins in AS.

Thermogravimetric analysis (TGA/DSC 3 +, Mettler Toledo) carried out in an inert medium ( $\text{N}_2$ ) showed that in the temperature range of 30-1040  $^{\circ}\text{C}$ , the AS lost 95.76 wt. %, which are the crystalline water phase (154 $^{\circ}\text{C}$ ) and the organic part (154 – 505 $^{\circ}\text{C}$ ) of the AS structure. With further increase in temperature (>505 $^{\circ}\text{C}$ ), the degradation of ARPD molecules through carbon-carbon and carbon-heteroatom bonds continues with a mass loss of 4.80 wt%.

AS recycling into useful carbon materials was carried out in an electric-arc vacuum-free reactor. A series of experiments of AS recycling with different conditions was carried out: the current strength of 100 A and the initiation time of 5, 10, 15, 20, 25 and 30 s. It was found that the initiation time of 5 s at 100 A was not sufficient to AS recycling, as the product of plasma treatment contains a viscous fraction of the remaining AS. According to the results of the X-ray phase analysis carried out with Shimadzu XRD 7000s, the current strength of 100 A and the initiation time of 30 s were taken as favorable conditions for plasma treatment of AS.

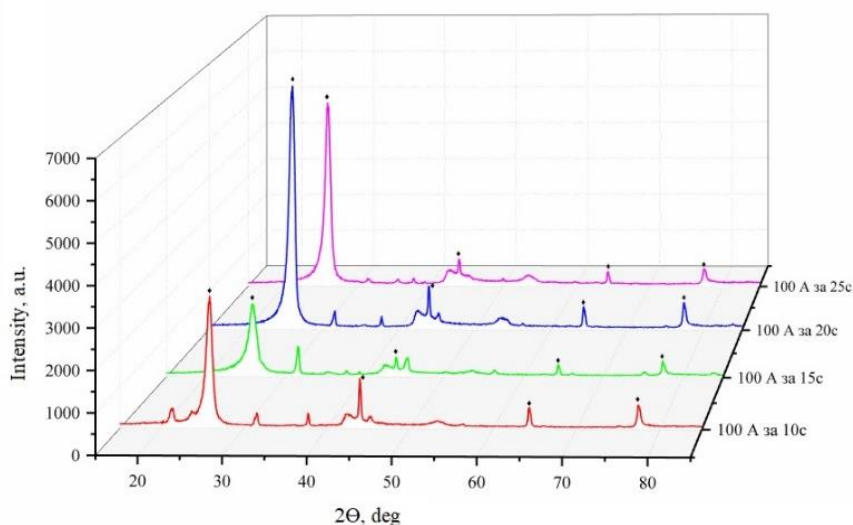

Fig. 1 Radiographs of AS plasma treatment products

Based on the results of the study, the possibility of obtaining carbon materials from oil waste was confirmed. 100 A, 30 s were taken as favorable conditions.

The work was financially supported by a grant of the Russian Science Foundation (project No. 22-13-20016) in SurGU and TPU.



## MICROSTRUCTURE OF GYAGG:Ce CERAMICS OBTAINED VIA DLP 3D-PRINTING

*Ermakova L.V., Smyslova V.G., Karpyuk P.V., Saifutyarov R.R., Sokolov P.S.*

National Research Center Kurchatov institute, Moscow, Russia

Graduate student

[ermakova.lydiav@yandex.ru](mailto:ermakova.lydiav@yandex.ru)

Ceramics based on a complex oxide with a garnet structure of composition  $(\text{Gd,Y})_3\text{Al}_2\text{Ga}_3\text{O}_{12}$  doped with cerium (GYAGG:Ce) are well-suited for luminescent and scintillation applications due to their characteristics: light output up to 52 photons/keV and an effective photoluminescence decay time of 65 ns [1]. Moreover, transparent garnet ceramics have an advantage over a single crystal in the possibility of modifying their precise composition, shape, and size.

By utilizing stereolithography (a 3D-printing process based on layered polymerization under UV-light irradiation), ceramics of complex geometry can be shaped with high precision. Not requiring any additional molds or blanks, this method bypasses traditional ceramics fabrication techniques, such as uniaxial pressing or casting. However, prior to high-temperature sintering, this process includes a step of debinding that results in the formation of most of the inner defects. While optimizing process conditions is certainly crucial, selecting the appropriate ceramic slurry composition is equally vital. The combination of these factors, along with sintering conditions, directly impacts the microstructure of the ceramics, ultimately affecting their optical and functional properties.

In this work, high-purity GYAGG:Ce powders were synthesized by co-precipitation of precursor nitrates mixture using  $\text{NH}_4\text{HCO}_3$ . Both stoichiometric and composition with an additional 5 wt.% of Y (from its initial amount in the powder composition) were studied. The UV-curable slurries preparation technique is described in [2]. To reduce slurry viscosity, a hyperbranched polyester-based dispersant was added to the mixtures along with a TPO photoinitiator to ignite a polymerization reaction.

Green bodies were then fabricated on DLP 3D-printer Ember (Autodesk, USA). The debinding process was taken in an inert atmosphere (95% Ar+5% $\text{H}_2$ ), followed by sintering in an air or oxygen atmosphere at a temperature range of 1600 to 1720 °C with a holding time of 2 hours. Cross sections of 3D-printed ceramics were obtained by grinding and polishing. The scanning electron microscope Jeol JSM 7100 F was used in back-scattered (BSE) mode to analyze the samples (Scheme 1).

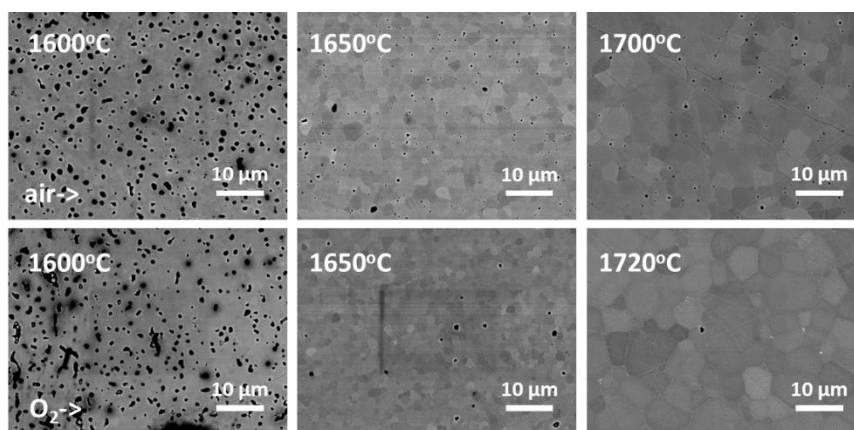

**Scheme 1.** Cross section of GYAGG:Ce ceramics depending on the temperature and sintering atmosphere

By raising the temperature and changing the atmosphere from air to oxygen, the number of inner pores in the material decreased significantly with a simultaneous increase in grain size. Transparent GYAGG:Ce ceramics were obtained at a temperature of 1720 °C.

### References

- [1] *J. Lumin.* **2021**, 234, 117933
- [2] *Glass. Ceram.* **2023**, 79(9), 395

### Acknowledgements

Analytical research was carried out using the equipment of the Research Chemical and Analytical Center NRC “Kurchatov Institute” Shared Research Facilities. The fabrication of scintillation ceramics was supported by the Russian Science Foundation under grant No. 22-13-00172, <https://rscf.ru/en/project/22-13-00172/>.

# FORMATION OF PEROXIDE SPECIES DURING PHOTOCATALYTIC WATER SPLITTING OVER TiO<sub>2</sub>-BASED PHOTOCATALYSTS

*Fazliev T.R., Selishchev D.S.*

Boreskov Institute of Catalysis, Novosibirsk, Russia

Novosibirsk State University, Novosibirsk, Russia

Student

[ft@catalysis.ru](mailto:ft@catalysis.ru)

Photocatalytic water splitting is a promising and environmentally friendly way to produce molecular hydrogen, which is a suitable compound for use as a fuel in many types of power generating systems, and other valuable chemical products, such as hydrogen peroxide.

This study was aimed to investigate the water splitting reaction without electron donors using photocatalysts based on nitrogen-doped titanium dioxide (TiO<sub>2</sub>-N). TiO<sub>2</sub>-N (100% anatase) was obtained by the method described in [1] and modified with metal co-catalysts (Pt, Pd, Cu) via reducing of metal precursor (H<sub>2</sub>PtCl<sub>6</sub>, PdCl<sub>2</sub>, Cu(OAc)<sub>2</sub>) with NaBH<sub>4</sub> in an amount of 1% wt. In addition, commercially available TiO<sub>2</sub> Evonik P25 (80% anatase, 20% rutile) was used as a benchmark photocatalyst to test the effect of nonmetal doping and the method of titanium dioxide production.

The photocatalysts based on TiO<sub>2</sub>-N had a high activity compared to 1%Pt/TiO<sub>2</sub> P25, but a gradual decrease in the rate of H<sub>2</sub> evolution was observed for all samples. No release of O<sub>2</sub> into the gas phase and H<sub>2</sub>O<sub>2</sub> into solution was observed during the experiments. This fact indicates that other routes of water oxidation reaction (WOR) take place. The formation of peroxide intermediates on the surface of TiO<sub>2</sub> has been described in the literature [2], therefore their accumulation and their negative influence on the activity of photocatalysts was assumed.

All photocatalysts based on TiO<sub>2</sub> P25 or TiO<sub>2</sub>-N after 12 h of irradiation were collected, dried under vacuum, and analyzed by diffuse reflectance infrared Fourier transform spectroscopy (DRIFTS) and mid-infrared attenuated total reflectance (MIR-ATR). For comparison, photocatalysts treated with 1% H<sub>2</sub>O<sub>2</sub> solution were also analyzed.

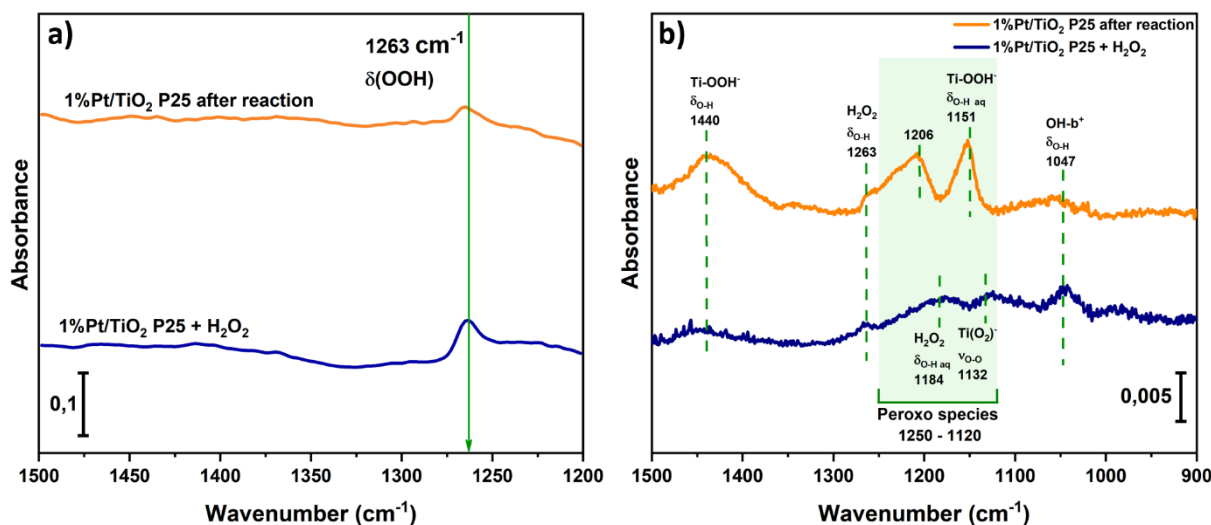

**Figure 1.** IR spectra of 1%Pt/TiO<sub>2</sub> P25 after reaction and treated with H<sub>2</sub>O<sub>2</sub> (+ H<sub>2</sub>O<sub>2</sub>) obtained with (a) DRIFTS and (b) MIR-ATR.

Figure 1 shows that the spectra of all samples have the characteristic peaks of surface chemisorbed peroxo compounds such as TiOOH', which are products of the WOR. The accumulation of these highly stable species leads to the deactivation of the photocatalyst by blocking the TiO<sub>2</sub> surface. Presumably, these compounds can be released into free form without irradiation over time, because one of characteristic peaks of H<sub>2</sub>O<sub>2</sub> is observed in IR spectra.

## References

- [1] *Catal. Commun.* **2020**, *134*, 105841
- [2] *J. Am. Chem. Soc.* **2003**, *125*, 7443

## PHYSICO-CHEMICAL FEATURES OF PULVERIZED COAL FUEL FOR BLAST FURNACES

*Amdur A.M.<sup>1</sup>, Fedorov S.A.<sup>1,2</sup>, Kurmacheva V.S.<sup>1</sup>*

<sup>1</sup> Ural State Mining University, Yekaterinburg, Russia

<sup>2</sup> Institute of Metallurgy UrB RAS, Yekaterinburg, Russia

Speaker, Candidate of Technical Sciences

[saf13d@mail.ru](mailto:saf13d@mail.ru)

The principal feature of pulverized coal fuel (PCF) is that, it is in a dispersed state unlike other components of the blast furnace charge. The size of individual particles  $R$  does not exceed 80-100 microns. The specific surface area of the PCF reaches 3.2-3.5 m<sup>2</sup>/g. It was determined by us using the BET method on the SORBI MS device. This value of the specific surface determines the physical and chemical properties and behavior of the material. Reactions of reduction or combustion on the surface of solid particles at temperatures above 900-1000°C are carried out in a diffusion mode. The reaction time  $t$  is proportional to  $R^2$ , which dramatically increases the rate of chemical interaction. For example, if a substance with 7.4 mm granules reacts for 600 seconds, then a suspension with a particle size of 74 microns is  $10^4$  times faster (in 0.06 s).

To determine the drying temperature of the PCF and the conditions of its combustion in the tuyere zone, the heating time of individual particles was estimated. The estimation was made using the example of coals and peat with a particle diameter of 80-100 microns. The heating was carried out to the temperature at which the drying and grinding of the PCF is carried out (250°C) and the blowing temperature in the tuyere zone. To do this, the parabolic differential equation of thermal conductivity (nonstationary case) was solved numerically in the Matlab package under Dirichlet boundary conditions. The heating time of peat particles is on the order of  $4-6 \times 10^{-2}$  s, for coal  $t$  is  $10^{-1}$  s. It is comparable to the time spent by the PCF particles in the tuyere zone, which leads to incomplete combustion.

New results have been obtained on the thermal destruction and combustion of a wide range of possible components of the PCF. These data were obtained using the STA 449 F5 Jupiter synchronous thermal analysis device combined with the QMS 403 Aeolos Quadro mass spectrometer (Netzsch). It is established that experimental data on the kinetics of coal destruction during heating are described by the Yander diffusion kinetics equations.

A method for selecting components of the PCF for blast furnaces has been developed. This method based on experimental laboratory studies (including the study of thermal degradation and combustion processes) and industrial experiments. The possibility of using previously unused milling peat as part of the charge has also been established.

### **Acknowledgements**

The research was funded by the Ministry of Science and Higher Education in accordance with the state assignment on science for Ural State Mining University №075-03-2024-132 dated 17.01.2024.

## NANOSCALE SYSTEM FOR THE HSP70 INTERACTOME ISOLATION FROM TUMOR CELLS

*Fedorov V.S.*<sup>1,2,3</sup>, *Likhomanova R.B.*<sup>1,2</sup>, *Yudintceva N.M.*<sup>1,2</sup>, *Ziganshin R.H.*<sup>4</sup>, *Bobkov D.E.*<sup>1,2</sup>,  
*Kolesnichenko Yu.V.*<sup>2,5</sup>, *Botalova D.P.*<sup>3</sup>, *Shevtsov M.A.*<sup>1,2,6</sup>

<sup>1</sup> Personalized Medicine Centre, Almazov National Medical Research Centre, St. Petersburg, Russia

<sup>2</sup> Institute of Cytology of the Russian Academy of Sciences (RAS), St. Petersburg, Russia

<sup>3</sup> St. Petersburg State University of Veterinary medicine, St. Petersburg, Russia

<sup>4</sup> Shemyakin-Ovchinnikov Institute of bioorganic chemistry Russian Academy of Sciences (RAS),  
Moscow, Russia

<sup>5</sup> St. Petersburg State University, St. Petersburg, Russia

<sup>6</sup> Klinikum rechts der Isar, Technical University of Munich, Munich, Germany  
Graduate student

[fedorovvs.biotech@gmail.com](mailto:fedorovvs.biotech@gmail.com)

Recent developments in nanotechnology presented various sustainable approaches for protein isolation and purification, as well as protein complex rebuilding and modelling [1,2]. One of the emerging extraction methods is the implementation of magnetic beads conjugated with various bioligands (e.g., antibodies, peptides, proteins nucleotides, etc) for the isolation of molecules of interest [3]. The idea of combining ligand-coated nanovehicles with magnetic precipitation might be also applied for proteins detection. Heat shock proteins (HSP), particularly of HSP70 family, are widely investigated in oncotheranostics due to their tumor-specific overexpression on plasma membrane and their role as a key hub for maintaining tumor progression [4]. However, the sheer amount of assisting and client proteins for HSPs, as well as a dynamic and heterogenous nature of chaperone cycle, create a challenge in HSP-associated proteomic investigations. The aim of this work was to develop reproducible nanoscale system with the capability to isolate HSP70-bound client peptides and proteins from tumor cells.

For extraction of HSP70 interactome we have developed the nanoscale system which was comprised of stable superparamagnetic iron oxide nanoparticles (SPIONs), coated with anti-Hsp70 monoclonal antibodies (anti-Hsp70-mAbs@SPIONs), and a set of affinity-controlling buffers. HSP70 interactome was extracted from brain tumor cells (human U251 and T98G glioblastoma cells) following consecutive cell lysis and gradient fractionation in order to separate cytosolic and membrane fractions. Resulting cell extracts were co-incubated with anti-Hsp70-mAbs@SPIONs in buffer solution which maintained closed conformation of HSP70 and preserved the chaperone interacting client peptides and proteins with high affinity. Following precipitation, the interactome-bearing particles were separated and incubated in a HSP70 conformation opening buffer, thus releasing client proteins in the sample. Interactome isolates were investigated employing mass spectrometry analysis.

The resulting nanoparticles were stable and exhibited superparamagnetic properties, which allowed their application in a rapid microvolume magnetic precipitation. Utilizing their HSP70 specificity, we were able to obtain reproducible quantities of protein sample from glioblastoma cells. Subsequent proteomic analysis of these samples revealed the presence of HSP70 as well as other major chaperome members (including HSP90, BAG, DNAJ proteins) and associated GTPases.

In conclusion, we synthesized nanoscale anti-Hsp70-mAbs@SPIONs particles for HSP70 interactome isolation from tumor cells which can be potentially employed in cancer diagnostics and treatment.

This work was supported by Ministry of Science and Higher Education of the Russian Federation (Agreement No. 075-15-2022-301).

### References

- [1] *Материалы национальной научной конференции профессорско-преподавательского состава, научных сотрудников и аспирантов*, Санкт-Петербург, 29 января – 02 февраля 2024 года. Санкт-Петербург: Санкт-Петербургский государственный университет ветеринарной медицины **2024**, 79. EDN LVGGKM
- [2] *Вопросы нормативно-правового регулирования в ветеринарии* **2016**, 2, 109 EDN WAIZEZ
- [3] *Am. J. Biomed. Sci. Res* **2020**, 8(1), 39. <http://dx.doi.org/10.34297/AJBSR.2020.08.001234>
- [4] *Philos. Trans. R. Soc. Lond. B Biol. Sci* **2018**, 373, 20160526.

# SYNTHESIS AND STUDY OF PHYSICAL-CHEMICAL AND FUNCTIONAL PROPERTIES OF A COMPOSITE ORGANIC-INORGANIC PHOTOCATALYST BASED ON COMPLEX TANTALUM OXIDE WITH A LAYERED STRUCTURE TYPE

*Frais M.S.<sup>1</sup>, Minich I.A.<sup>1</sup>, Zvereva I.A.<sup>1</sup>*

<sup>1</sup> St. Petersburg State University, St. Petersburg, Russia  
Student  
[st098177@student.spbu.ru](mailto:st098177@student.spbu.ru)

Layered perovskite-like oxides is a family of compounds that consist of two-dimensional perovskite slabs interleaved with so-called interlayer space usually represented by cations or cationic structural units. They attract a great interest of researches due to their wide range of physicochemical properties and applications. For example, it was shown that these compounds have high catalytic and photocatalytic activity [1], which makes them promising materials used as photocatalysts for the production of hydrogen from aqueous-organic media, in particular, from biomass processing products. Another important feature of layered oxides is their ability to undergo ion-exchange and topochemical reactions, which makes it possible to obtain new compounds and nanostructured materials based on them by soft chemistry approaches, in particular, new hybrid organic-inorganic compounds, nanosheets and composite materials.

The goal of the present work is the synthesis of organic-inorganic hybrids based on tantalate  $\text{CsSr}_2\text{Ta}_3\text{O}_{10}$  by ion exchange reaction (protonation) and subsequent modification of interlayer space with organic moieties by intercalation and grafting reactions. To characterize the obtained compounds and study their properties methods of X-ray phase analysis, IR spectroscopy, thermogravimetry, diffuse reflectance spectroscopy and scanning electron microscopy were used.

In this work, tantalate  $\text{CsSr}_2\text{Ta}_3\text{O}_{10}$  was obtained by high-temperature ceramic method. The protonated form of the oxide was obtained by an ion exchange reaction using nitric acid. The possibility to synthesize organic-inorganic hybrids with *n*-amines, TBAOH and *n*-alcohols was investigated by solvothermal and microwave-assisted heating. In order to investigate the impact of topochemical modification on photocatalytic properties of obtained compounds, the starting fully-inorganic tantalates and selected organic-inorganic hybrids were tested in the reaction of hydrogen production from water-methanol mixture.

## References

[1] Materials Research Express **2018**, 5(9)

# SYNTHESIS AND EXFOLIATION OF ORGANIC-INORGANIC HYBRIDS OF PEROVSKITE-LIKE BISMUTH NIOBATE BY TOPOCHEMICAL REACTIONS

*Gabdrakhmanov R.R.<sup>1</sup>, Minich I.A.<sup>1</sup>, Zvereva I.A.<sup>1</sup>*

<sup>1</sup> St. Petersburg State University, St. Petersburg, Russia

Student

[st106778@student.spbu.ru](mailto:st106778@student.spbu.ru)

Layered perovskite-like oxides are interesting objects of research. The relevance of this structural type of compounds is determined by a wide range of their physicochemical properties. Among them, the ability of layered oxides to undergo ion exchange and topochemical reactions is of great importance. Organic-inorganic hybrids based on protonated forms of layered oxides currently represent a new promising class of materials whose properties can be changed by targeted modification of both organic and inorganic components. The compounds thus obtained are considered as promising materials with photocatalytic, catalytic, magnetic, and luminescent properties [1].

The present work is devoted to the synthesis of organic-inorganic hybrids based on CsBiNb<sub>2</sub>O<sub>7</sub> niobate by its protonation, subsequent intercalation and grafting of the interlayer space with organic compounds and exfoliation of the obtained hybrids. The methods of X-ray phase analysis, IR spectroscopy, <sup>13</sup>C NMR spectroscopy, CHN elemental analysis, thermogravimetry, scanning electron microscopy were used to characterize the obtained samples, the band gap values were calculated from diffuse reflectance spectroscopy data.

Within the framework of this study, CsBiNb<sub>2</sub>O<sub>7</sub> niobate was synthesized by ceramic high-temperature method. The protonated form was obtained by ion exchange reaction using concentrated nitric acid. Organic-inorganic hybrids of HBiNb<sub>2</sub>O<sub>7</sub> with *n*-butylamine, TBAOH and a number of alcohols and phenols were synthesized using solvothermal and microwave-assisted heating. It was found that grafting with phenols resulted in a change in the color and light absorption of the samples, from white, corresponding to absorption in the UV region of the spectrum to yellow corresponding to absorption in the visible region of the spectrum, as evidenced by a decrease in the band gap. Thus, this approach can be used to obtain new photocatalysts active in the visible region of the spectrum.

## References

[1] M. Johnsson and P. Lemmens, "Crystallography and Chemistry of Perovskites," Handb. Magn. Adv. Magn. Mater., vol. 4, pp. 1–9, 2007

## SYNTHESIS OF FLUORESCENT ALBUMIN NANOPARTICLES BY DESOLVATION METHOD

*Galaeva Z.R.*<sup>1,2</sup>, *Khramtsov P.V.*<sup>1,2</sup>

<sup>1</sup>Institute of Ecology and Genetics of Microorganisms, Ural Branch of the Russian Academy of Sciences, Perm, Russia

<sup>2</sup>Perm State National Research University, Perm, Russia

Student

[galaevazarina@psu.ru](mailto:galaevazarina@psu.ru)

Albumin nanoparticles are used as targeted delivery for drugs (e.g. Abraxane, approved for clinical use) due to low toxicity and albumin capability to bind small organic molecules. Moreover, fluorophore-loaded albumin nanoparticles can be used *in vivo* and *in vitro* diagnostics, homogeneous fluorescent immunoassays, and bioimaging [1-2]. Nanoparticles loaded with fluorescent molecules exhibit higher fluorescent signal intensity compared to single molecules. The aim of this work was to optimize the synthesis of albumin nanoparticles loaded with fluorescent europium complexes. A long fluorescence duration (over 1 ms), a narrow emission band, and a large Stokes shift are Europium advantages. These fluorescent characteristics are distinctive to lanthanides, that allows them to be used as detection agents in analyses of biological samples. We assume that the use of nanoparticles containing fluorescent europium complexes will reduce detection limits in homogeneous immunoassays and flow cytometry. Organic ligands, 1,10-phenanthroline and methyl 4-(4-methylphenyl)-2,4-dioxobutanoate were used to capture excitation radiation and transfer it to europium.

The desolvation method is one of the simplest and widest used methods of protein nanoparticles synthesis. The point of the method is a gradually adding a poor solvent (e.g. ethanol, acetone or methanol) to a water protein solution. In this case, the protein aggregates and forms spherical nanoparticles. Another advantage of the desolvation method is that the fluorescent complexes of europium chloride, 1,10-phenanthroline and methyl 4-(4-methylphenyl)-2,4-dioxobutanoate do not need to be synthesized and purified beforehand. The complexes were formed *in situ* during the addition of an ethanolic solution of europium and ligands to an aqueous protein solution. The formed fluorescent complexes were captured by the hydrophobic pockets of albumin and thus encapsulated into nanoparticles. After synthesis, nanoparticle suspensions were subjected to thermal cross-linking at a temperature of 70 °C for 2 hours. Then, the nanoparticles were washed with water from non-desolvated fluorescent complexes, BSA and ethanol using 20-minute-long centrifugation cycles at 20,000 g. After each centrifugation pellets were resuspended using ultrasound. After the final wash, nanoparticles were resuspended in a certain volume of deionized water and stored at +4 °C.

The synthesis conditions of fluorescent nanoparticles were optimized by investigating the effects of various parameters (the pH of the water BSA solution, the concentration of europium cations, and the rate of addition of the alcohol solution). Our aim was to attain the maximum fluorescence intensity and minimum polydispersity. The fluorescence intensity was measured at wavelengths of 360 nm for excitation and 615 nm for emission. Nanoparticle sizes and polydispersity were measured by dynamic light scattering (DLS).

These nanoparticles are planned to be used in homogeneous fluorescent immunoassays.

### References

- [1] International Journal of Pharmaceutics **2021**, 599, 120422
- [2] Advances in Colloid and Interface Science **2017**, 246, 13–39

### Acknowledgements

This work was supported by the Russian Science Foundation (project No 24-25-00266).

## PROMISING PHOTOCATALYSTS BASED ON POLY(TRIAZINE IMIDE)

*Golovin M.S.<sup>1</sup>, Mironova A.T.<sup>1</sup>, Zakharchenkova V.P.<sup>1</sup>, Bulatova E.A.<sup>1</sup>, Bol'shakov O.I.<sup>1</sup>*

<sup>1</sup> South Ural State University, Chelyabinsk, Russia.  
Postgraduate Student  
[golovinms@susu.ru](mailto:golovinms@susu.ru)

Photocatalysis is an environmentally friendly and safe method for the oxidation of organic substances. Therefore, it is a promising technology that could provide a «green» synthesis route for a range of industrially important chemicals. The main photocatalysts are transition metal oxides TiO<sub>2</sub>, ZnO, Fe<sub>2</sub>O<sub>3</sub>. Compared with other semiconductors,  $\alpha$ -Fe<sub>2</sub>O<sub>3</sub> has a narrow band gap (E<sub>g</sub>~2.1 eV) and excellent chemical stability<sup>1</sup>. It is non-toxic and environmentally friendly material. The main disadvantage of  $\alpha$ -Fe<sub>2</sub>O<sub>3</sub> is the high recombination rate of photogenerated electron-hole pairs. This process leads to a decrease in photocatalytic activity.

In recent decades, organic photocatalysts such as carbon nitride have been developed. g-C<sub>3</sub>N<sub>4</sub> is a two-dimensional heptazine-based semiconductor with excellent photocatalytic properties.

Its allotropic modification, poly(triazine imide) (PTI)<sup>2</sup>, showed better results in photocatalysis compared to melon or g-C<sub>3</sub>N<sub>4</sub> due to its high crystallinity and low band gap. Like most carbon nitrides, PTI is usually prepared by sintering precursors (melamine, urea or thiourea) in a eutectic mixture. It is inexpensive and easy to manufacture. Unfortunately, the efficiency of pure graphitic carbon nitride g-C<sub>3</sub>N<sub>4</sub> and poly(triazinimide) is limited due to the high recombination rate of photogenerated e<sup>-</sup>/h<sup>+</sup>.

Research has shown that by combining  $\alpha$ -Fe<sub>2</sub>O<sub>3</sub> with other catalysts to form heterojunctions, its catalytic performance can be improved. Most of the known carbon-based Fe<sub>2</sub>O<sub>3</sub> composites have been applied in the field of photocatalysis<sup>3</sup>. That is why in this work it was proposed to create a composite material based on iron oxide and poly(triazine imide).

Since selective synthesis of organic substances by visible light is a promising method for «green» synthesis, we decided to study the potential activity of the synthesized composite material for the photooxidation of benzyl alcohol to benzaldehyde.

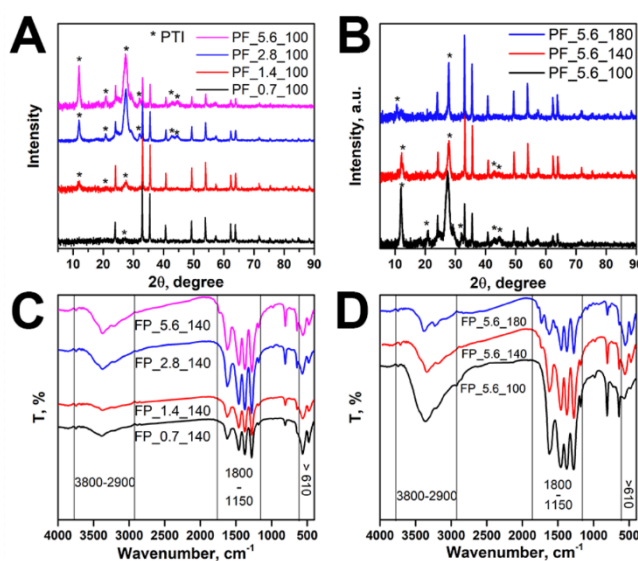

**Scheme 1.** (A) X-ray diffractometry of the samples with different PTI : Fe<sub>2</sub>O<sub>3</sub> ratio; (B) with different temperature of HT treatment (100 – 180 °C); (C) FTIR-spectra of the samples with different PTI : Fe<sub>2</sub>O<sub>3</sub> ratio; (D) with different temperature of HT treatment (100 – 180 °C).

### References

- [1] *Journal of Environmental Management*, **2020**, 258, 110050
- [2] *Journal of Chemical Sciences*, **2021**, 133, 133
- [3] *Materials Research Bulletin*, **2013**, 48, 1447

### Acknowledgements

This work was funded by Ministry of Science and Higher Education of the Russian Federation (agreement № 075-15-2022-1135) and South Ural State University, and Ministry of Science.



## ANALYSIS OF THE PROPERTIES OF CERIUM OXIDE NANOPARTICLES

*Goryacheva E.A.<sup>1</sup>, Strokin P.D.<sup>1</sup>, Goryacheva O.A.<sup>1</sup> Popova N.P.<sup>2</sup>, Goryacheva I.Y.<sup>1</sup>*

<sup>1</sup> Saratov State University, Saratov, Russia

<sup>2</sup> Institute of Theoretical and Experimental Biophysics of RAS, Moscow, Russia

Student

[goryacheva.e.05@mail.ru](mailto:goryacheva.e.05@mail.ru)

Nanotechnology contributes to the development of science, energy, electronics and biomedical analysis. Nanoparticles based on rare earth oxides fluoresce, have insignificant toxicity compared to analogues as well as antioxidant properties [1-3]. These nanoparticles affect biological systems due to their inherent high oxygen nonstoichiometry. At the moment, the properties of luminescent cerium oxide nanoparticles have hardly been studied.

In the presented work, the following properties of luminescent cerium nanoparticles were analyzed: the size of nanoparticles, wavelength of the luminescence maximum, quantum yield, width of the luminescence peak at half-height, colloidal stability, and distribution of the number of obtained nanostructures by fractions (table 1).

Fraction	Hydrodynamic radius, nm			QY, %	PLW, nm	FWHM, nm	Amount of precipitator, ml
5 minutes of synthesis	24	51	170	6	478	97	-
35 minutes of synthesis	87			6	481	102	-
55 minutes of synthesis	55			5	481	97	-
1 fraction	51			2	486	113	-
2 fraction	3	51	69	2	483	116	5 ethanol 3 acetone
3 fraction	24	108		2	484	110	5 ethanol 6 acetone
4 fraction	3	660		2	480	103	5 ethanol 9 acetone
5 fraction	4	146		1	486	96	5 ethanol 19 acetone 10 isopropyl alcohol

**Table 1.** Properties of cerium oxide nanoparticles.

### References

[1] Antioxidants. **2021**. V. 10(5). P.660.

[2] Molecular cancer therapeutics. **2014**. V. 13(7). P. 1740-1749.

[3] Oxidative stress: diagnostics, prevention, and therapy. American Chemical Society. **2011**. P. 235-253.

### Acknowledgements

This work was supported by the Russian Science Foundation (project No 22–63–00082).

# APPLICATION OF 3D TRANSITION METAL-CONTAINING SILICA IN SYNTHESIS OF CARBON NANOTUBES

*Gradov A.E.*<sup>1</sup>

<sup>1</sup> Saint Petersburg State Institute of Technology (Technical University), St. Petersburg, Russia

PhD student

[gradov2708@gmail.com](mailto:gradov2708@gmail.com)

Carbon nanotubes (CNTs) are promising materials, which can find application in different scientific fields because of its unique structure, physico-chemical properties, mechanical properties and control modification. Development of CNTs research has been beginning since 1991 and by the moment there are a lot of synthesis methods of CNTs have designed. The most effective method is chemical vapor deposition (CVD).

Postnov V.N. and et al. [1] stress a point about using of cobalt-containing silica in synthesis of CNT. Therefore, aim of this work is to carry out research about impact of adsorbed on silica 3d transition metals (Cu, Ni, Ag, Zn, Co) amminates on growth and yield of CNTs. Silica was coarse-porous column silica gel (CSC-2). Metal ions of amminates were Cu( II ), Ni( II ), Ag, Zn, Co( II ).

Synthesis of CNTs was performed by CVD at 600 °C, carbon source was ethanol [1]. After synthesis, the product was dissolved with a mixture of concentrated hydrofluoric acid and nitric acid. The catalyst for CNTs growth was obtained by the reaction of chemisorption of metal amminates on CSC-2. The metal concentration in the catalyst was measured using the ICP-AES method with preliminary extraction of metal ions from the surface of the catalyst with concentrated nitric acid. The carbon yield was determined by the ratio of the mass of CNT to the mass of the catalyst. Identification of CNTs was performed by Raman spectroscopy, X-ray diffraction, X-ray photoelectron spectroscopy, TEM, SEM.

The most effective catalyst in terms of carbon yield was observed in application of cobalt-containing silica, exactly 4,2%. The lowest carbon yield – using nickel-coating silica. Metal concentrations in synthesized catalysts were 4.0 % (Co), 2.8 % (Cu), 0.4 % (Ag), 4.9 % (Zn), and 1.7 % (Ni). The largest adsorption on CSC-2 was observed in zinc. For example, on the Scheme 1 there is a TEM image of CNTs synthesized on zinc-coating silica.

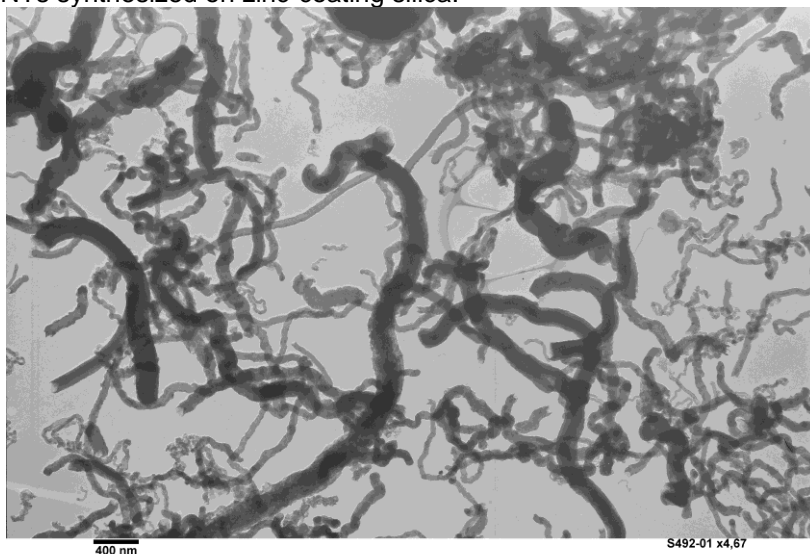

**Scheme 1.** TEM image of CNTs on zinc-coating silica

Therefore, we synthesized and identified CNTs synthesized with silica-based catalysts contained some 3d transition metals amminates. Cobalt-congaing silica is the most effective catalyst in synthesis of CNTs with this CVD method. In further research we are going to carry out research about impact of other catalysts on morphology and yield of CNT.

## References

[1] *Separations*. **2021**, 8(4), 50

# MOF-COATED UPCONVERSION NANOPARTICLE AGENTS ENABLE SYNERGISTIC PHOTODYNAMIC THERAPY AND IMMUNOTHERAPY

Jiarui Du<sup>1</sup>, Guanying Chen<sup>1</sup>

<sup>1</sup> Harbin Institute of Technology, Harbin, China

Student, Master's degree

[dujiarui@stu.hit.edu.cn](mailto:dujiarui@stu.hit.edu.cn)

Integrating biocompatible metal–organic frameworks (MOFs) with upconversion nanoparticles (UCNPs), capable of converting near-infrared (NIR) light into visible or ultraviolet emissions, affords unique UCNPs@MOFs heterostructures for nanomedicine. Alongside inherited advantages from parent UCNPs on imaging and parent MOFs with porous structure on chemodrugs delivery, upconversion Förster resonance energy transfer (FRET) from UCNPs to molecular moieties in MOFs offers unique abilities to probe or modulate intracellular and tumor microenvironments at high spatiotemporal precision.<sup>1</sup>

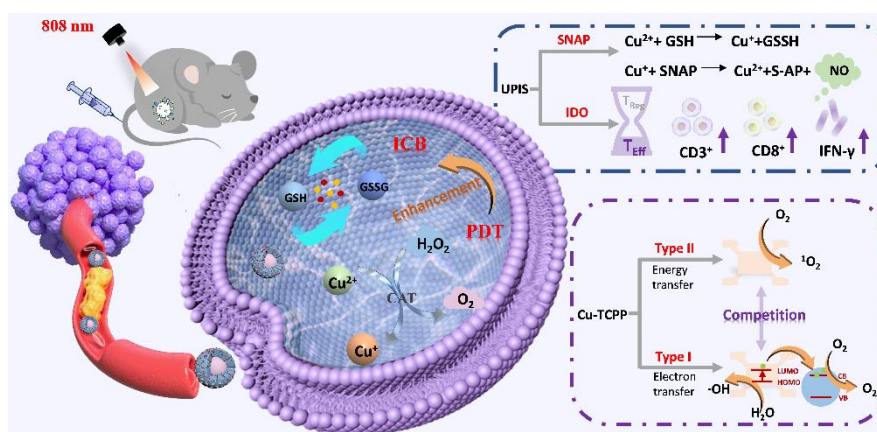

**Scheme 1.** A schematic illustration of the mechanisms of synergistic photodynamic and immunotherapy for primary and distant tumors.

Here, a core-shell UCNP@MOF (upconversion nanoparticle-metal organic framework) nanoagents is constructed for Type I and Type II photodynamic therapy under biocompatible near-infrared light irradiance (at 808 nm) and utilize their pore loading capacity to further realize synergistic immunotherapy in solid tumors. The  $\text{Cu}^{2+}$  to  $\text{Cu}^+$  reduction at the nodes in the MOFs shell is demonstrated to promote the generation of reactive oxygen species via depletion of overexpressed glutathione (GSH) compounds, while tumor microenvironment-enriched hydrogen peroxide is found to substantially augment the PDT effects. Importantly, the MOFs pore-loaded indoleamine 2,3-dioxygenase (IDO) inhibitor, along with s-nitroso-n-acetylpenicillamine (SNAP), upregulated tumor-infiltrating lymphocytes and induced prominent immunotherapeutic effects *in vivo*.<sup>2</sup> This core-shell UCNP@MOF nanoagents have demonstrated effectiveness against both primary and distant tumors in xenografted tumor models, holding promise for treating solid tumors in metastasis.

## References

- [1] *Adv. Optical Mater.* 2023, 2202122
- [2] *Adv. Funct. Mater.* 2024, 2401272

## Acknowledgements

This work was supported by the grants from the National Natural Science Foundation of China (52272270 and 51972084) and the Young Scientist Workshop (Harbin Institute of Technology) (AUGA9803502318).

## INDIUM METAL-ORGANIC FRAMEWORK AS A POTENTIAL DRUG DELIVERY SYSTEM

*Kalmakhelidze M.V., Mukhanova E.A.*

International Research Institute of Smart Materials of the Southern Federal University, Rostov-on-Don,

Russia

PhD Student

[kalmahelidze@sfedu.ru](mailto:kalmahelidze@sfedu.ru)

Metal-organic frameworks (MOFs) are highly porous compounds that can accommodate drugs. To be used as nanosized drug carriers, MOFs must have several properties: low toxicity, biodegradability, biocompatibility, and water stability [1]. Currently, indium compounds are widely investigated in biological and medical applications. The antibacterial, antifungal, and antiviral potentials of indium (III) complexes have been comprehensively discussed [2]. Therefore, it can be considered as a potential drug delivery system for some amino acids. L-histidine itself has antioxidant and anti-inflammatory properties. L-histidine has been shown in many studies to scavenge both hydroxyl radicals and singlet oxygen. Many recent studies have demonstrated the therapeutic efficacy of "pharmacological" doses of L-histidine in animal models of inflammatory conditions, particularly gastrointestinal disease and cardiac ischemia-reperfusion injury, and have specifically linked histidine's anti-inflammatory properties to its ability to scavenge toxic oxygen species [3].

The new In-MOF was synthesized using the microwave method. The crystal structure of the MOF was analyzed by powder X-ray diffraction. FTIR spectroscopy and TGA analysis were also performed. Particle morphology was determined using transmission electron microscopy (TEM). UV–Vis spectroscopy and impedance spectroscopy were used to investigate the drug loading of In-MOF particles.

As a result, the kinetics of L-histidine loading into the In-MOF was studied for the first time. Maximum loading was achieved 20 min after placing the In-MOF in the L-histidine solution. The possibility of L-histidine inclusion was confirmed by modeling using the TOPOS Pro program.

### References

- [1] *Current Medicinal Chem.* **2020**, *27*, 5949
- [2] *Chemistry Africa* **2024**, *7*, 1729
- [3] *The Jour. of Nutritional Biochem.* **1998**, *9*, 308

### Acknowledgements

The research was supported by the Strategic Academic Leadership Program of the Southern Federal University ("Priority 2030")

# STUDY OF IONIC CONDUCTIVITY OF NANOPOROUS MEMBRANES WITH ELECTRICALLY CONDUCTIVE CARBON COATING

*Kharchenko I.A.*<sup>1,2</sup>, *Ryzhkov I.I.*<sup>1,3</sup>, *Simunin M.M.*<sup>1,3</sup>, *Lebedev D.V.*<sup>4,5,6</sup>, *Vaulin N.V.*<sup>4,6</sup>

<sup>1</sup>Institute of Computational Modeling, Federal Research Center KSC SB RAS, Krasnoyarsk, Russia

<sup>2</sup>Kirensky Institute of Physics, Federal Research Center KSC SB RAS, Krasnoyarsk, Russia

<sup>3</sup>Siberian Federal University, Krasnoyarsk, Russia

<sup>4</sup>Saint Petersburg Academic University, St. Petersburg, Russia

<sup>5</sup>Saint Petersburg State University, St. Petersburg, Russia

<sup>6</sup>Institute of Analytical Instrumentation RAS, St. Petersburg, Russia

Engineer, Postgraduate

[harchenko@icm.krasn.ru](mailto:harchenko@icm.krasn.ru)

Ion transport in nanoporous membranes plays an important role in many technological processes such as desalination, water separation and purification. The ability of nanopores to transport ions under the influence of an applied electric field is characterized by ionic conductivity, which is the ratio of the ion current to the voltage difference.

This work investigates ion transport in porous anodic alumina membranes with carbon nanotubes. Porous membranes were prepared by the two-step anodization followed by removal of aluminum and barrier layer with electrochemical detection of pore opening [1]. As a result, free-standing nanoporous membranes with a diameter of 10 mm and a thickness of 70  $\mu\text{m}$  were obtained. The SEM image of typical membrane surface is shown in Fig. 1a. Carbon nanotubes inside the pores with an internal diameter of  $\sim 16$  nm are clearly visible. The ionic conductivity was measured in KCl aqueous solution in a specially designed cell, where membrane was placed between two compartments with equal salt concentrations. The wire Ag/AgCl electrodes were used to apply voltage between the compartments (from  $-0.5$  to  $0.5$  V) and to measure the resulting ionic current.

(a)

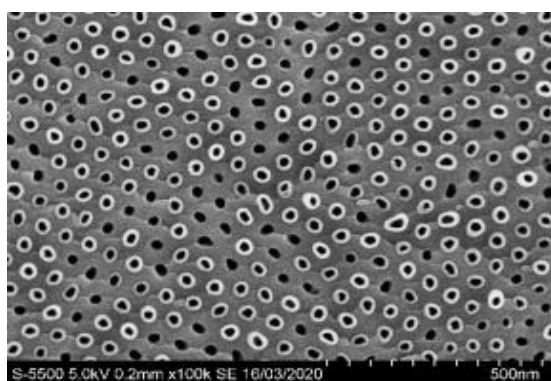

(b)

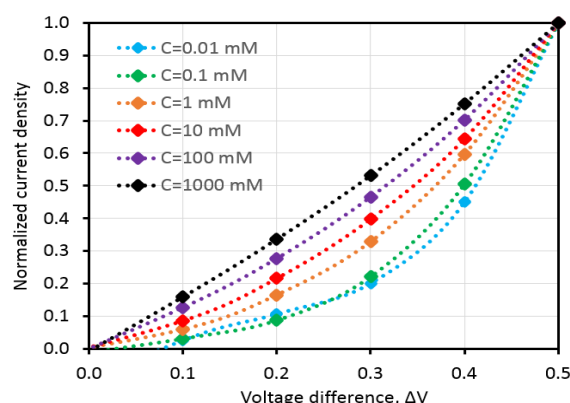

**Figure 1.** SEM image of porous anodic alumina membrane with carbon nanotubes (a);

The dependence of normalized current density on the applied voltage difference for different salt concentrations (b).

The experimentally obtained current-voltage curves are shown in Fig. 1b. The polarization of electrically conductive surface by the applied electric field induces the surface charge, which leads to the increase of charge carriers (cations or anions) concentration inside the nanopore resulting in the increase of conductivity. This polarization becomes stronger with increasing the voltage difference, so the observed current-voltage curves are non-linear. This effect is most pronounced at low concentrations, while at high concentrations, the current-voltage curves become linear. In conclusion, we have experimentally confirmed the effect of ionic conductivity enhancement in electrically conductive nanoporous membranes.

## References

[1] *I.I. Ryzhkov, I.A. Kharchenko et al. Growth of carbon nanotubes inside porous anodic alumina membranes: Simulation and experiment. Int. J. of Heat and Mass Transfer, 2021. V. 176, 121414.*

**Acknowledgements.** The work is supported by the Russian Science Foundation, project 23-19-00269.

# MODIFIED GRAPHITIC CARBON NITRIDE-BASED COMPOSITES AS PHOTOCATALYSTS FOR HYDROGEN PRODUCTION UNDER VISIBLE LIGHT

*Kharina S.N.<sup>1</sup>, Kurenkova A.Yu.<sup>1</sup>, Kozlova E.A.<sup>1</sup>*

<sup>1</sup>Borisev Institute of Catalysis SB RAS, Novosibirsk, Russia

Postgraduate

[skharina@catalysis.ru](mailto:skharina@catalysis.ru)

Nowadays, chemical technologies aimed at hydrogen production are rapidly evolving, with a significant focus being placed on the development of alternative methodologies, such as photocatalysis. A promising photocatalyst for hydrogen generation is graphitic carbon nitride g-C<sub>3</sub>N<sub>4</sub> due to its narrow band gap (2.7 eV) and high reduction potential of photogenerated electrons [1]. However, pristine g-C<sub>3</sub>N<sub>4</sub> exhibits low activity in photocatalytic reactions, which is attributed to the high recombination rate of photogenerated electrons and holes, as well as low adsorption of reactants on the photocatalyst surface [2]. Thus, the present research is to elaborate synthesis of modified g-C<sub>3</sub>N<sub>4</sub> and its visible-active composite photocatalysts (x wt.% g-C<sub>3</sub>N<sub>4</sub>/1 wt.% Pt/TiO<sub>2</sub> (x=0-99%)) for hydrogen generation from glucose water solutions.

The initial components used in the synthesis are samples of commercial TiO<sub>2</sub> Evonik P25 calcined at 750 °C and g-C<sub>3</sub>N<sub>4</sub>, which has been obtained by thermal polycondensation (T=600 °C, 2 h) of melamine and then subjected to calcination at 500 °C for 1 h in air. The deposition of platinum particles on the surface of TiO<sub>2</sub> and g-C<sub>3</sub>N<sub>4</sub> has been carried out by chemical precipitation. The composites have been synthesized by mechanical dispersion of g-C<sub>3</sub>N<sub>4</sub> and 1% Pt/TiO<sub>2</sub> in acetone. The characterisation of the samples has been conducted using X-ray diffraction (XRD), X-ray photoelectron spectroscopy (XPS), high-resolution transmission electron microscopy (HR-TEM) and diffuse reflectance electron spectroscopy (DRS).

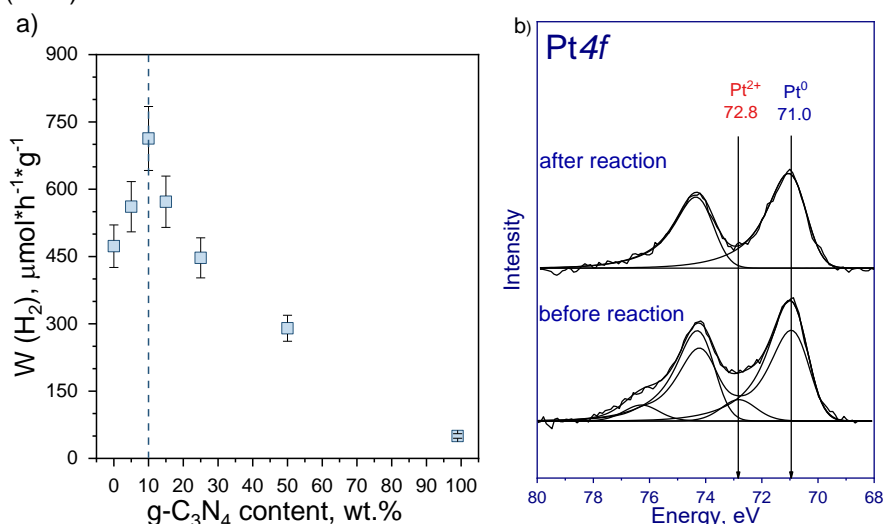

The photocatalytic activity has been measured in an aqueous solution of alpha-D(+)-glucose (C<sub>0</sub>=0.1 M) at 20 °C and 1 atm using LED radiation (440 nm). The results indicate the following dependence of the photocatalytic activity  $W(\text{H}_2)$  on the mass fraction of g-C<sub>3</sub>N<sub>4</sub> in the samples. With the increase of g-C<sub>3</sub>N<sub>4</sub> loading up to 10 wt.% the hydrogen release rate increases and reaches 713  $\mu\text{mol}\cdot\text{H}_2\cdot\text{g}^{-1}\cdot\text{h}^{-1}$ , which is 1.5 times higher than the activity of 1% Pt/TiO<sub>2</sub> (473  $\mu\text{mol}\cdot\text{H}_2\cdot\text{g}^{-1}\cdot\text{h}^{-1}$ ). Further rise in the mass fraction of g-C<sub>3</sub>N<sub>4</sub> leads to a smooth decrease of  $W(\text{H}_2)$  to 50  $\mu\text{mol}\cdot\text{H}_2\cdot\text{g}^{-1}\cdot\text{h}^{-1}$  for 1% Pt/g-C<sub>3</sub>N<sub>4</sub>. According to XPS data, the photocatalyst surface composition remains unchanged despite Pt<sup>2+</sup> undergoing reduction to Pt<sup>0</sup>, suggesting that platinum nanoparticles act as electron sinks.

## References

- [1] *Applied Surface Science Advances* **2022**, 11, 100273.
- [2] *Journal of Materials Science & Technology* **2020**, 56, 70.

## Acknowledgements

This work was supported by the Russian Science Foundation (project No 23-73-01161).

# INVESTIGATION OF CERIUM FLUORIDE NANOPARTICLES MODIFIED WITH FLAVIN MONONUCLEOTIDE FOR PHOTODYNAMIC THERAPY APPLICATION

*Kornienko A.I.<sup>1,2</sup>, Ivanov V.E.<sup>1</sup>, Popova N.R.<sup>1</sup>*

<sup>1</sup> Institute of Theoretical and Experimental Biophysics, Russian Academy of Sciences, Pushchino, Russia

<sup>2</sup> Moscow State University, Moscow, Russia

Master's Degree student

[An.Kor7@yandex.ru](mailto:An.Kor7@yandex.ru)

X-ray excited deep photodynamic therapy (XPDT) is based on the use of scintillation materials as photosensitizers (PS). This method addresses the challenge of treating deep-seated tumors, as classical PDT using lasers can only treat superficial formations [1].

Therefore, an urgent task of modern radiation biomedicine is to discover new pharmaceutical agents for XPDT. In this study, we propose a novel combination of scintillation nanoparticles (NPs) based on cerium fluoride (CeF<sub>3</sub>), which is functionalized with flavin mononucleotide (FMN). CeF<sub>3</sub> is a highly effective scintillator that demonstrates X-ray fluorescence with a broad maximum around 325 nm (UV region). FMN exhibits strong absorption in the UV/visible spectrum (peaks at 220, 265, 375, and 445 nanometers), suggesting the potential for energy transfer from CeF<sub>3</sub> to FMN and activation of the latter [2, 3]. The aim of this study was to synthesize and characterize the physicochemical characteristics of the nanoparticles, as well as to investigate their cytotoxicity towards normal and transformed cells in vitro.

CeF<sub>3</sub> NPs were synthesized by precipitation in alcoholic media. The NPs were then functionalized by the addition of a FMN solution. CeF<sub>3</sub> NPs were synthesized by the precipitation method in an alcoholic medium. The nanoparticles were then functionalized by the addition of a FMN solution. Transmission electron microscopy revealed that the resulting NPs had a predominantly spherical morphology. The study of the spectral characteristics using spectrophotometry and spectrofluorimetry indirectly supported the possibility of energy transfer between CeF<sub>3</sub> and FMN in the synthesized nanosystem. Dynamic light scattering demonstrated that all nanoparticles have a hydrodynamic diameter less than 200 nm, which makes them suitable for biomedical applications. It has been determined that the fluorescence quantum yield of CeF<sub>3</sub> NPs is 0,50, whereas for the CeF<sub>3</sub>+FMN complex, it is 0,16. Based on these findings, it can be concluded that in our nanosystem, FMN efficiently absorbs light emitted by excited CeF<sub>3</sub>. Using electrophoretic light scattering techniques, it has been shown that the charge of the NPs is in the range of +37 to +47 mV. This indicates a high level of stability and a low level of NPs aggregation in the system that we have synthesized. It has been determined that freshly prepared sol solution samples exhibit an acidic pH level. Given that these nanomaterials are intended for use in biomedical applications, it is essential to adjust the pH to a neutral value. To accomplish this, a dialysis procedure was employed, which, as demonstrated by the study, resulted in an increase in the pH value by approximately 1,5-fold within a 24-hour period.

The cytotoxicity of the synthesized CeF<sub>3</sub> and FMN-modified CeF<sub>3</sub> NPs was evaluated using the MTT assay and the Live/Dead assay on mouse fibroblast (L929), mouse melanoma (B16-F10), and human epidermoid carcinoma (A431) cells. The cells were incubated with the samples at concentrations of 10<sup>-6</sup>, 10<sup>-5</sup>, 10<sup>-4</sup>, 10<sup>-3</sup> M. It was found that within the tested concentration range, neither CeF<sub>3</sub> nor CeF<sub>3</sub>+FMN nanoparticles exhibited cytotoxic effects on normal (L929) or transformed (B16-F10 and A431) cells, did not decrease their viability, and did not reach the IC<sub>50</sub> value within 24-72 hours of incubation.

These results are promising for potential research into FMN-functionalized CeF<sub>3</sub> NPs in X-ray studies.

## References

- [1] *ChemPlusChem*. **2020**, *85*, 510.
- [2] *Journal of Nanoparticle Research*. **2015**, *17*, 7.
- [3] *Methods in Molecular Biology*. 2014, 1146, 3.

## Acknowledgements

This work was supported by the Russian Science Foundation (project No 23-23-00564).

# DEVELOPMENT OF CURCUMIN-LOADED PLGA NANOPARTICLES WITH OPTIMIZED RELEASE RATE USING FACTORIAL DESIGN OF EXPERIMENT

*Kotova J.O., Kovshova T.S., Vinokurov E.G., Gelperina S.E.*

Mendeleev University of Chemical Technology of Russia, Moscow, Russia

Postgraduate student

[juliakot1412@gmail.com](mailto:juliakot1412@gmail.com)

Manufacturing of the nanoparticle-based drug delivery systems (DDS) depend on a large number of technological parameters. The optimal conditions are usually selected empirically, which is a resource- and time-consuming process. At the same time, the R&D process can be optimized by using design of experiments methods, which allow to identify the most significant parameters (factors) affecting the properties of the product [1].

The aim of this work was to obtain the PLGA nanoparticles (NP) with slow release of curcumin (Cur) chosen as the model drug. The NPs were prepared by the nanoprecipitation method; the following parameters were varied: polymer structure (i.e. lactic and glycolic acid monomer ratio [LA/GA], end groups structure [EG], molecular weight [Mw]), polymer and curcumin concentrations ( $C_{PLGA}$  and  $C_{Cur}$ ), rate of addition of the organic phase to aqueous phase ( $\nu$ ), and stirring rate ( $\omega$ ).

The fractional factor design of the experiment (DoE) was used to identify the process parameters exerting the most considerable influence on the Cur release and to determine the optimal conditions for the nanoparticle preparation. This method enables evaluating of the influence of more than five parameters (factors) and significantly reduces the number of experiments required to select the optimal technique [2]. The factors were varied at 2 levels.

The curcumin release rate was investigated as described in [3]. The release profiles of Cur were evaluated in phosphate buffer saline (PBS, pH 7.4) containing 0.1% w/v of Tween-80 to prevent precipitation of Cur in the aqueous media. The NPs were resuspended in the model medium to achieve the total Cur concentration of less than 10  $\mu\text{g/mL}$ , and then the mixture was incubated at 37°C under stirring at 150 rpm. The 1-ml aliquots of the mixture were withdrawn at 0 min, 30 min, 1h, 2h, 4h, 6h, 8h, and 24 h with the medium replacement. The samples were centrifuged at 16000 g and 4°C for 20 min to separate the nanoparticles. The Cur content was determined in the supernatant spectrophotometrically (425 nm).

The data analysis using the factorial DoE indicated that the main influencer of the Cur release rate was the  $C_{PLGA}$ . The method optimization of the particle preparation technique using DoE resulted in the significant decrease of the Cur burst release rate (0 min) from 95% to 60%.

## References

- [1] *Eur. J. Pharm. Sci.* **2019**, 138, 105037
- [2] *J. Controlled Release* **2023**, 358, 398.
- [3] *Colloids Surf., B. Biointerfaces* **2019**, 184, 110515

## Acknowledgements

The research was carried out within the state assignment of Ministry of Science and Higher Education of the Russian Federation (project FSSM-2022-0003).



# ATOMIC LAYER DEPOSITION OF ZINC-TITANIUM AND ALUMINIUM-TITANIUM OXIDE NANOCOATINGS ON MAGNESIUM ALLOYS AND INVESTIGATION OF THEIR CORROSION PROTECTION AND BIOMEDICAL PROPERTIES

*Kozlova L.A.<sup>1</sup>, Rytova M.A.<sup>2</sup>, Vartiainen V.V.<sup>2</sup>, Nazarov D.V.<sup>1,2</sup>*

<sup>1</sup> St. Petersburg State University, St. Petersburg, Russia

<sup>2</sup> Peter the Great Saint Petersburg Polytechnic University, Saint Petersburg, Russia  
Student

[lada.kozlova.20@mail.ru](mailto:lada.kozlova.20@mail.ru)

In recent times, magnesium-based materials have emerged as a promising class of temporary implants due to their remarkable properties, including strength, biocompatibility, biodegradability, and bioactivity. However, the practical use of magnesium implants is constrained by a number of issues associated with accelerated biodegradation. In this context, it is crucial to regulate the rate of biocorrosion by implementing coatings. One of the most promising methods for preparing protective biocompatible coating is atomic layer deposition (ALD), which is based on surface chemical reactions between gaseous reagents and the substrate. This method allows the production of homogeneous, uniform, conformal coatings and the ability to control the thickness and composition of complex oxide coatings with high precision.

In this work, simple zinc, titanium, aluminium, zinc-titanium (ZTO) and aluminium-titanium (ATO) oxide thin films were prepared by atomic layer deposition on a surface Mg-based MA2-1pch alloy with a thickness of approximately 40 nm. For ALD of complex oxide coatings, the supercycle approach was employed. This approach involves the synthesis of a sequence of several single ALD cycles of simple oxide systems, forming a supercycle. ZTO and ATO nanocoatings were deposited at 200°C using diethyl zinc (DEZ), trimethylaluminium (TMA), deionized water, and titanium tetrachloride (TiCl<sub>4</sub>) or titanium tetraisopropoxide (TTIP) as precursors.

Scanning electron microscopy (SEM) data showed that the coatings obtained were homogeneous and uniform in thickness. However, particles with different morphology and size were found on the surface of some samples. The chemical composition of the surface and the volume of the nanocoatings were investigated using X-ray photoelectron spectroscopy (XPS) and energy dispersive X-ray spectroscopy (EDX), respectively. The results demonstrated that ATO and TiO<sub>2</sub> coatings obtained using titanium tetrachloride do not contain chlorine at ALD on the surface of a model substrate—silicon—while chlorine-containing impurities are formed when similar samples are obtained on magnesium.

The biocorrosion rate of the obtained samples was evaluated by potentiodynamic curves, which were measured in physiological Ringer's solution. The samples with ATO series coatings demonstrated the most significant reduction in biocorrosion rates, while the TiO<sub>2</sub> obtained using TiCl<sub>4</sub> exhibited minimal reduction in corrosion currents.

The adhesion, viability, and differentiation of osteoblast-like osteosarcoma cells (MG-63) and human mesenchymal stem cells (FetMSC) were investigated to analyze the biocompatibility of the obtained coatings. The results demonstrated high adhesion and spreading of MG-63 and FetMSC on the surface of all samples. The samples of TiO<sub>2</sub>-TTIP and all aluminum-containing samples exhibited no cytotoxicity, while the TiO<sub>2</sub>-TiCl<sub>4</sub> and zinc-containing samples exhibited slight cytotoxicity. The differentiation of MG-63 and FetMSC cells in the osteogenic direction was studied using the marker of early differentiation, alkaline phosphatase (ALP), after two weeks of cell cultivation on the surface of samples. The ALP activity of the MG-63 cell line on the surface of the ATO-TiCl<sub>4</sub> and ATO-TTIP samples was found to be slightly higher than that of the control sample. This indicates that these samples may facilitate the differentiation of MG-63 in an osteogenic direction.

Thus, the ATO oxide nanofilms obtained by the ALD have a great potential for use as anticorrosive and biocompatible coatings for magnesium-based implants.

## **Acknowledgements**

This work was supported by the Russian Science Foundation grant (project No. 22-73-00093 and 24-73-00115). The research was conducted using the equipment of the resource centers of the Research Park of the St. Petersburg State University "Innovative Technologies of Composite Nanomaterials", "Center for Physical Methods of Surface Investigation", "Nanotechnology Interdisciplinary Center", "X-ray Diffraction Studies", "Nanophotonics" and "Center for Molecular and Cell Technologies".

# LUMINESCENT SENSORS OF HUMAN BODY TEMPERATURE BASED ON COPPER(I) CLUSTER WITH THIAMAZOLE AND NATURAL POLYSACCHARIDES

*Kritchenkov I.S., Kritchenkova A.Kh.*

Institute of Technical Acoustics NAS of Belarus, Vitebsk, Belarus

Senior Researcher, PhD

ilya.kritchenkov@gmail.com

Body temperatures, as well as its homeostasis, are critical for warm-blooded animals, and deviations of this parameter from the norm can be a cause or an indication of the presence of serious pathological processes.

In many cases, the problem of non-contact determination of body temperature is solved using thermal imaging technology, but it is usually characterized by low accuracy (in common cases about 1°C), and also cannot be used at the micro level, for example, in studying biological processes in cells.

An alternative method for determining temperature is the use of temperature-sensitive phosphors. Currently, the most common luminescent temperature sensors are organic substances and lanthanide complexes[1]. The most promising compounds published in the literature[1] have a sensitivity of about 3–4% per degree K in the temperature range of 32–42 °C, which is lower than that of our phosphorescent composite sensors.

It is also worth noting that only a few phosphors (for example, fluorescein and indocyanine green) have proven to be biocompatible and approved for medical use. The composites we obtained contain only biocompatible components: copper ions, thiamazole (an approved drug) and polysaccharide biopolymers.

We synthesized a copper(I) cluster with thiamazole using a modified procedure that has advantages over that published in the original paper (Figure 1).

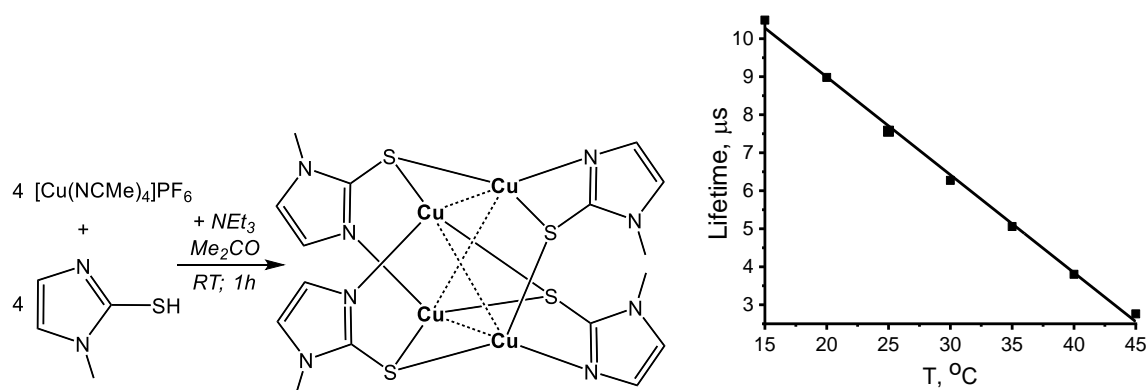

**Figure 1.** Scheme of the synthesis of the copper(I) cluster (left) and temperature dependency of the excitation state lifetime of this complex (right)

This cluster was found to have intense phosphorescence with a maximum emission band at a wavelength of 480 nm. The data we obtained on the luminescent and sensory properties of this cluster are new and have not previously been reported in the literature.

Photophysical studies have shown that this compound has effective sensing properties to temperature fluctuations in the physiological range (32 to 42°C) with a sensitivity of about 5% per K.

Using ultrasound, composites of this cluster with biopolymers such as chitosan, starch and pullulan were obtained. It has been established that the introduction of this phosphor into the biopolymer matrix does not affect the photophysical properties: the cluster in the composite retains effective phosphorescence and thermal sensitivity.

## References

[1] *Chemical Society Reviews* **2013**, *42*, 7834–7869

## Acknowledgements

The work was carried out with the financial support of the Belarusian Republican Foundation for Basic Research, project No. T24U-004.

# NEW APPROACHES FOR THE FUNCTIONALIZATION OF FEW-LAYER BLACK PHOSPHORUS WITH THE FORMATION OF COVALENT P–C BONDS

*Kuchkaev Aidar M.<sup>1</sup>, Kuchkaev Airat M.<sup>1</sup>, Yakhvarov D.G.<sup>1</sup>*

<sup>1</sup>Arbuzov Institute of Organic and Physical Chemistry, FRC Kazan Scientific Center, Russian Academy of Sciences, Kazan, Russia  
Junior researcher, PhD  
[Kuchkaev95@mail.ru](mailto:Kuchkaev95@mail.ru)

Owing to its extraordinary puckered and highly anisotropic structure, unique semiconducting properties, high charge mobility, and good biocompatibility, 2D few-layer black phosphorus (FLBP) finds applications in various fields, such as electro- and photocatalysis, Li-ion and Na-ion batteries, field-effect transistors, supercapacitors, biomedical materials, etc. However, low environmental stability severely limits its processing in ambient conditions. Chemical functionalization and modification of the structure of FLBP can significantly improve its oxidation stability and promote the tailoring of its chemical, optical, and electronic properties [1].

Herein, we report the first experimental approach for covalent functionalization of FLBP with carbene intermediates using dichlorocarbene as model reagent [2], as well as a facile *one-pot* approach for simultaneous electrochemical exfoliation and methylation of black phosphorus (BP) [3].

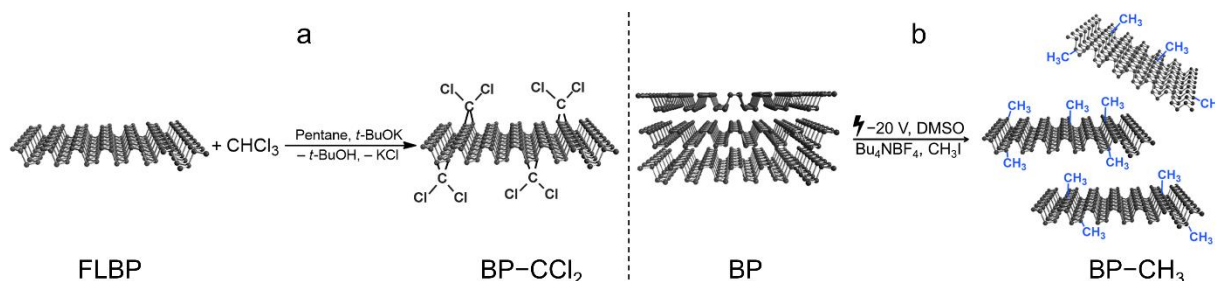

**Figure 1.** Schematic illustration of the preparation of BP- $\text{CCl}_2$  (a) and BP- $\text{CH}_3$  (b).

Size, thickness, and morphology of the obtained materials (BP- $\text{CCl}_2$  and BP- $\text{CH}_3$ ) were characterized by the methods of atomic force microscopy and transmission electron microscopy. The covalent functionalization of BP- $\text{CCl}_2$  and BP- $\text{CH}_3$  were confirmed by IR, Raman, XPS and solid-state NMR spectroscopy methods. Additionally, the possibility of the application of functionalized FLBP as a metal-free electrochemical hydrogen evolution catalyst is also presented.

## References

- [1] *Energy Technol.* **2021**, *9*, 2100581.
- [2] *Nanomaterials* **2023**, *13*, 826.
- [3] *Int. J. Mol. Sci.* **2023**, *24*, 3095.

## Acknowledgements

This work was supported by the Russian Science Foundation (project No 23-13-00427).

# THE EFFECT OF THE REINFORCING PHASE PARTICLE SIZE ON THE MECHANICAL PROPERTIES OF COMPOSITE MATERIALS WITH A NICKEL MATRIX

*Kudymov V.K.<sup>1</sup>, Dermenji A.<sup>1</sup>, Zemtsova E.G.<sup>1</sup>, Smirnov V.M.<sup>1</sup>*

<sup>1</sup> St. Petersburg State University, St. Petersburg, Russia

First-year master Student

[st075880@student.spbu.ru](mailto:st075880@student.spbu.ru)

Modern industry needs new generation materials with improved mechanical properties compared to the known ones. In particular, in the space, machine-building and aviation industries, there is a need for materials that, in addition to improved mechanical characteristics, have increased heat-resistance properties. Composite materials with a nickel matrix meet these requirements.

To create the most durable composites with a Ni matrix, it is necessary to use a reinforcing phase – particles, filaments or sheets with high hardness and strength values. Carbon-containing compounds, e.g. metal carbides, as well as allotropic modifications of pure carbon, such as nanotubes and nanodiamonds, have proven well as such reinforcing phases. However, when such particles are introduced into the metal matrix, a difficulty arises – carbides and carbon particles are not wetted with metal. As a result of this, defects occur in the material, significantly reducing its functional properties. To overcome this, we decided to cover the reinforcing phase particles by Ni shell to improve wetting.

The purpose of our work was to study the effect of the reinforcing phase of different composition and size on the mechanical properties of the composites obtained by us. Materials reinforced with particles of the micron order (titanium carbide coated with Ni) and nanoparticles (nanodiamonds and nanodiamonds coated with Ni) were studied.

As a result of the work, series of composites with a reinforced Ni matrix were obtained. The materials have higher mechanical properties compared to pure Ni. Values of Vickers hardness of the materials obtained can be seen in Figure 1.

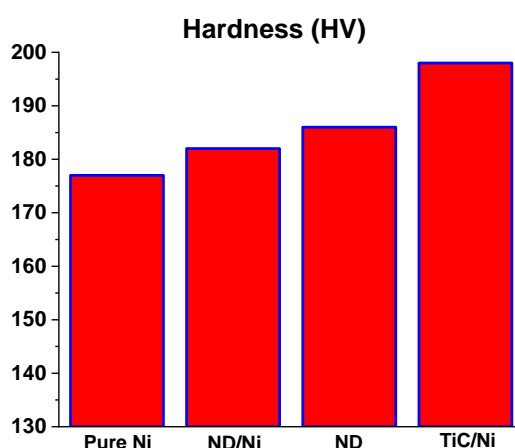

Fig.1. Vickers hardness of materials with different reinforcing phases  
ND – nanodiamonds

The highest hardness for TiC particles reinforced materials of the micron order and coated with a Ni shell is due to a more uniform distribution arisen from increased wettability between the metal matrix and carbide. The hardness of nanodiamonds-reinforced materials has increased less, since nanoparticles have high surface energy and are most prone to aggregation. Also, the coating of particles with a Ni shell affects the strength properties. Materials reinforced with Ni-coated particles have higher tensile strength and elongation, which is also due to a more uniform reinforcing phase distribution.

## Acknowledgements

The research was carried out with the financial support of the Russian Science Foundation, Agreement No. 23-21-00421. The author expresses gratitude to the St. Petersburg State University Science Park, RC "Center for the Study of Extreme States of Materials and Structures", RC "Nanotechnology", RC "Physical methods of surface Research"

# STUDY OF THERMAL DECOMPOSITION OF HYDROSILICATE NANOSCROLLS ON THE BASIS OF THE SYSTEM $\text{Mg}_3\text{Si}_2\text{O}_5(\text{OH})_4\text{-Ni}_3\text{Si}_2\text{O}_5(\text{OH})_4$

*Kurguzkina M.E.<sup>1,2</sup>, Ugolkov V.L.<sup>1</sup>*

<sup>1</sup> Institute of Silicate Chemistry, Russian Academy of Sciences (ISC RAS), St. Petersburg, Russia

<sup>2</sup> Saint Petersburg Electrotechnical University 'LETI', St. Petersburg, Russia

Postgraduate student

[kotovamaria715@gmail.com](mailto:kotovamaria715@gmail.com)

Modern science has been directed towards the development of nanotechnology for several decades. Nanocomposite materials are of particular interest. There is a possibility of their application in catalytic reactions and in separation membranes for liquid and air media. Inorganic nanotube magnesium-nickel hydrosilicates were chosen as precursors for the production of composite catalysts and pervaporation membranes. Magnesium hydrosilicate  $\text{Mg}_3\text{Si}_2\text{O}_5(\text{OH})_4$  with chrysotile structure is unique due to its structural feature and important properties for practical applications. Hydrosilicate layered particles can fold under certain conditions due to excessive strain energy and difference in chemical composition on the outer and inner side of the layer [1]. The high specific surface area becomes one of the results of the process of multiple folding of the hydrosilicate particle, which makes this material promising in adsorption processes and for catalytic applications. One of the most significant properties of this material is its resistance to high temperatures [2]. The obtained composite materials with the inclusion of a small amount of magnesium hydrosilicate nanoparticles showed increased thermal stability due to the nanotubes embedded in the polyamide matrix [3]. Materials based on nickel hydrosilicate  $\text{Ni}_3\text{Si}_2\text{O}_5(\text{OH})_4$  with chrysotile structure demonstrated thermal stability and good catalytic activity in carbon dioxide conversion of methane [4].

This study is devoted to investigate the thermal decomposition process of hydrosilicate nanotubes based on the  $\text{Mg}_3\text{Si}_2\text{O}_5(\text{OH})_4\text{-Ni}_3\text{Si}_2\text{O}_5(\text{OH})_4$  system.

Hydrosilicates of the composition  $(\text{Mg}_{1-x}\text{Ni}_x)_3\text{Si}_2\text{O}_5(\text{OH})_4$  ( $x \in [0, 1]$ ) were prepared using the hydrothermal synthesis method. The starting mixture contained co-precipitated hydroxides of the composition  $\text{Mg}_{1-x}\text{Ni}_x(\text{OH})_2$  ( $x \in [0, 1]$ ) and silicon dioxide. The  $\text{Ni}_3\text{Si}_2\text{O}_5(\text{OH})_4$  sample was prepared from  $\text{Ni}(\text{OH})_2$  and nickel metasilicate  $\text{NiSiO}_3$ . Sodium hydroxide solution with a concentration of 0.38 M was the medium for synthesis. The suspensions were treated for 24 h at a temperature of 350 °C - 400 °C and a pressure of about 70 MPa. Electron microscopic study was carried out to determine the chemical composition of the products. X-ray diffraction analysis of samples was carried out before and after thermal treatment of all samples. TG/DSC analysis was performed on the compressed tablets, in the temperature range from 25 °C to 1000 °C. To determine the change in phase composition, heat treatment of samples of the composition  $(\text{Mg}_{1-x}\text{Ni}_x)_3\text{Si}_2\text{O}_5(\text{OH})_4$ , where  $x = 0; 0.3; 0.5; 0.7; 1.0$  at temperatures of 500, 600 and 700 °C, for 2 hours, was carried out.

Heat treatment of all hydrosilicate samples in the temperature range of 25-1000 °C initiated several processes accompanied by thermal effects and mass losses. The dehydroxylation of the outer surface of the hydrosilicate nanotube occurs at a temperature of 500-700 °C with the formation of a semi-amorphous sepiolite-like phase  $(\text{Mg}_{1-x}\text{Ni}_x)_4\text{Si}_6\text{O}_{15}(\text{OH})_2$ . In this regard, the endothermic effect of this process was found to be quite broad. The mass loss during dehydroxylation is about 7-10 %. The exothermic effect at temperatures above 800 °C corresponded to the crystallisation of Mg-Ni-forsterite. The crystallisation of the Mg-Ni-forsterite phase becomes more difficult with increasing nickel content in the hydrosilicate. The exothermic effect becomes less intense and its minimum shifts to higher temperatures. In the sample of  $\text{Ni}_3\text{Si}_2\text{O}_5(\text{OH})_4$  the effect completely disappears, and crystallisation of forsterite-like phase does not occur at all, instead NiO phase is formed, which is confirmed by the data of X-ray diffraction analysis.

## References

- [1] *Crystals* **2020**, *10*, 654
- [2] *Chem. Int. Ed.* **2004**, *43*, 2017-2020
- [3] *J. Macromol. Sci., Phys.* **2014**, *53*, 555-567
- [4] *Microporous Mesoporous Mater.* **2011**, *140*, 69-80

## Acknowledgements

The work was carried out within the framework of the state assignment of IHS RAS with the support of the Ministry of Education and Science of Russia (project No. 1023032900322-9-1.4.3).

# LASER-INDUCED CARBONIZATION OF SURFACE-GROWN Ni-BDC FOR THE CREATION OF THE BEND SENSOR FROM PET WASTE

*Kurtsevich E.A.<sup>1</sup>, Kogolev D.A.<sup>1</sup>, Fatkullin M.I.<sup>1</sup>, Postnikov P.S.<sup>1</sup>*

<sup>1</sup> National Research Tomsk Polytechnic University, Tomsk, Russia

Junior researcher, PhD student

[eak123@tpu.ru](mailto:eak123@tpu.ru)

Waste polymers are one of the available feedstocks for the preparation of novel materials [1]. Significant progress in the waste valorization has forced chemists to consider other applications of such feedstock especially in the design of smart devices for “Internet of Things” (IoT) [2].

Among other wastes, polyethylene terephthalate (PET) is promising polymer for functional upcycling due to the easiness of structure modification [3] and possibility to extract terephthalates for further preparation of metal-organic frameworks (MOFs). Recently, we have found that surface MOFs are able to form graphene-like conductive layers *via* laser-induced carbonization [4].

Here, we developed the pathway of functional upcycling waste PET by laser-induced carbonization of Ni-BDC on the PET surface for the bend sensor design (Figure 1A). The laser treatment of PET@Ni-BDC led to the formation of specific pattern on the surface distinguished by high mechanical stability and exceptional performance (more than 1000 bending cycles at the bending angle of 44°) (Figure 1 B-D).

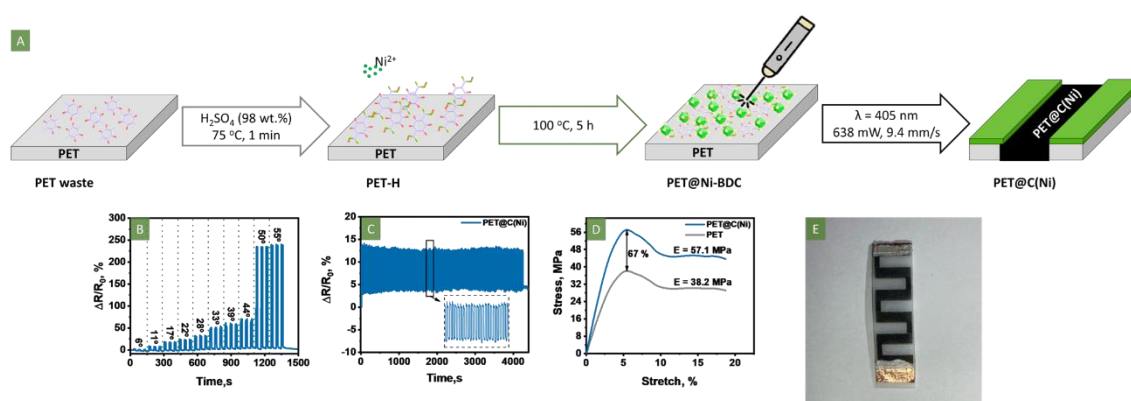

**Figure 1.** A) Laser-induced carbonization of Ni-BDC on the PET surface. Resistive and mechanical characteristics of PET@C(Ni): B) resistance response to the bending depth; C) long-term durability testing during 1000 cycles of stretch and relax; D) tensile strength PET and PET@C(Ni); E) image of the bend sensor

The bend sensor demonstrated the reproducible response on bending (Figure 1E). The linear response was observed in the range of  $32 \pm 1\%$  up to  $44^\circ$  (Figure 1B). Reliability and stability of the sensor during cyclic bending were steady with deviation less than 3% between the starting and the end point (Figure 1C). The tensile strength of the composite material PET@C(Ni) changed from 38.2 to 57.1 MPa compared to pristine PET (Figure 1D). Thus, the composite material PET@C(Ni) is promising for the implementation as a bend sensor within the “IoT” concept.

## References

- [1] *Chem. Soc. Rev.* **2023**, *52*, 4755
- [2] *Nano Futures.* **2020**, *4*, 012001
- [3] *Appl. Mater. Today.* **2021**, *22*, 100910
- [4] *J. Mater. Chem. A.* **2023**, *11*, 1108

# EFFECT OF PROCESSING SOLVENT ON THE HOLE TRANSPORT IN ORGANIC SEMICONDUCTOR SMALL MOLECULES

*I. E. Kuznetsov*<sup>1</sup>, *A. A. Piryazev*<sup>1,3</sup>, *D. K. Sagdullina*<sup>1</sup>, *D. V. Anokhin*<sup>1</sup>, *A. N. Zhivchikova*<sup>2</sup>,  
*M. E. Sideltsev*<sup>1</sup>, *M. M. Tepliakova*<sup>2</sup>, *D. A. Ivanov*<sup>1,3</sup>, *A. V. Akkuratov*<sup>1</sup>

<sup>1</sup> Federal Research Center of Problems of Chemical Physics and Medicinal Chemistry, Russian Academy of Sciences, Chernogolovka, Russian Federation

<sup>2</sup> Skolkovo Institute of Science and Technology, Moscow, Russian Federation

<sup>3</sup> Sirius University of Science and Technology, Sochi, Russian Federation  
Senior Researcher

[kusnetsovija@gmail.com](mailto:kusnetsovija@gmail.com)

Organic electronics is an actively developing area that allow fabrication of biocompatible devices with unique properties such as flexibility, light weight, stretchability, and transparency. The characteristics of such devices depend on the semiconductor properties of the active layer materials, which in turn are associated with the morphology of films. Morphology control can be achieved through various approaches, including thermal and vapor annealing [1,2], the use of additives and co-solvents. However, the most advanced method is the selection of the optimal solvent for film deposition [3]. Herein, we employ solvent engineering to investigate the morphology behavior and modulate the charge transport characteristics of **TB-T**, **TB-Ph**, **TB-TPh**, and **TB-Tz** small molecules (SMs) consisting of thiophene-, benzene-, di(thiophen-2-yl)benzene, and thiazolothiazole-bridged (4-octyl-5-(alkylsilyl)thiophen-2-yl)benzothiadiazole moiety, respectively (Figure 1). As an eco-friendly counterpart to widely used chlorobenzene, we selected non-polar hexane.

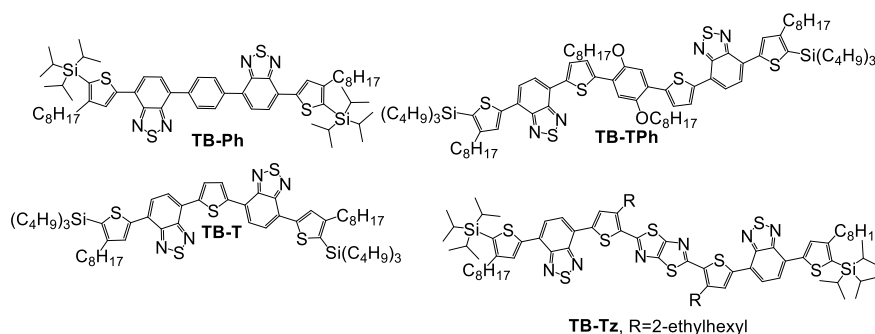

**Figure 1.** Small molecules **TB-Ph**, **TB-T**, **TB-TPh**, and **TB-Tz**.

We systematically investigated optical properties, morphology, and charge-transport characteristics of four conjugated SMs in thin films with respect to the processing solvents. Employing AFM and GIWAXS techniques, we found that the hole transport in donor-acceptor SMs is drastically affected by the film morphology and that the longer the length of the orientational order of molecules, the higher the mobility. Particularly, the highly oriented texture of hexane-cast **TB-TPh** films allowed to achieve the highest hole mobilities as compared to those of films based on thiophene-, and thiazolothiazole-bridged molecules, which showed minor enhancement in mobility. The favorable morphological changes occurring in the case of **TB-Ph** when applying hexane resulted also in a remarkable boosting of hole mobility, although the transport of charge carriers was limited by the discrepancy of alignment of the valence band of **TB-Ph** and the work function of ITO electrode.

Our study paves the way toward replacing halogenated solvents with environmentally preferable solvents as a straightforward approach to control the morphology and improve the electrophysical properties of organic semiconductor materials.

## References

- [1] *J. Mater.Chem. A* **2017**, 5, 18101
- [2] *Chem. Asian J.* **2016**, 11, 2620
- [3] *Dyes Pigments* **2021**, 194, 109560.

## Acknowledgements

The part of this work was supported by the state assignment of the Ministry of Science and Higher Education of the Russian Federation (project No 122111700041-8 (FFSG-2022-0004)).

## LUMINESCENT PROPERTIES OF CALCIUM TUNGSTATE DOPED WITH RARE EARTH ELEMENTS

*Kuznetsova P.D.<sup>1</sup>, Mukhanova E.A.<sup>1</sup>*

<sup>1</sup> Southern federal university, Rostov-on-Don, Russia

Graduate student

[pkuznecova@sfedu.ru](mailto:pkuznecova@sfedu.ru)

Photodynamic therapy for cancer greatly benefits from the use of X-ray activated phosphors.[1] Low-temperature conditions are being investigated for the potential incorporation of rare-earth elements into the structure of scheelite-structured calcium tungstate. It is shown that scheelite nanoparticles can be synthesized using microwave, microfluidic, and ultrasonic techniques with varying particle sizes. Calcium tungstate doped with trivalent lanthanides Ln<sup>3+</sup> (Ln = Eu, Nd, Ce, Pr, Sm) was subjected to X-ray Excited Optical Luminescence (XEOL) and ultraviolet-visible (UV-Vis) spectroscopy. Doping scheelite with europium resulted in the most notable increase in luminescence, according to an analysis of the luminescent properties. Examining the X-ray absorption spectrum in the XANES region measured beyond the L<sub>3</sub>-edge of tungsten, it can be concluded that there is a significantly higher density of free d-states on the W atom. This phenomenon corresponds to the p-d transitions. To calculate the defect energy resulting from aliovalent substitution, the Mott-Littleton method was employed. It is proven that the defect energies differ insignificantly when substituting with various lanthanides.

### References

[1] *Inorg. Chem. Commun.* **2022**, *140*, 109407

### Acknowledgements

The research was supported by the Strategic Academic Leadership Program of the Southern Federal University ("Priority 2030").



# TEMPLATE-FREE SYNTHESIS OF POROUS METAL- AND METALLOID-BASED NANOMATERIALS WITH THE USE OF THE EUTECTIC SODIUM-POTASSIUM ALLOY AS A REAGENT

*Leonchuk S.S.<sup>1</sup>, Falchevskaya A.S.<sup>1</sup>, Morozova P.A.<sup>2</sup>, Gromov N.V.<sup>1</sup>, Vinogradov V.V.<sup>1</sup>*

<sup>1</sup> ITMO University, SCAMT International Institute, St. Petersburg, Russia

<sup>2</sup> Skolkovo Institute of Science and Technology, CEST, Moscow, Russia

PhD student, engineer

[ssleonchuk@yandex.ru](mailto:ssleonchuk@yandex.ru)

Functional materials with controllable porous structures are seen as promising options for a variety of applications in materials science, such as energy storage, catalysis, purification technologies, and green chemistry [1]. Various facile and versatile solution methods have been developed to aid these applications, including solvothermal and sol-gel synthesis, selective leaching, self-assembly, and template methods [2]. Although, many of these traditional approaches are limited in their scalability.

In contrast, liquid metal-mediated approaches offer a potentially valuable alternative for material production. For instance, gallium and gallium-indium alloy (GaIn) can serve as agents for creating porous structures from metals and oxides, as well as sacrificial templates and structure-directing agents for producing hollow-structured materials with different compositions and shapes [3, 4]. Unfortunately, these approaches are not suitable for producing most metalloids due to gallium's lower reduction potential. Recent studies have shown that sodium-potassium alloy (NaK), another liquid metal, could address this limitation as sodium and potassium have two of the highest reduction potentials among metals [5]. So far, this liquid-metal alloy has been used to create mesoporous carbon, silicon, and germanium. However, this synthetic approach still has limitations in controlling the structure, morphology, and porosity of the final materials.

In this study, we are developing a novel method to suggest a potential solution to the issues mentioned above by utilizing the eutectic liquid NaK-78 alloy for simultaneous chemical reduction, structure directing, and pore formation processes. The formation of porous materials in our method is provided by NaK alloy emulsions acting as sacrificial templates. A wide variety of functional materials, such as carbon, silicon, germanium, tin, antimony, iron, ruthenium, tantalum, niobium, titanium, and their oxides, with well-organized pore structures and specific surface areas ranging from 10 to 2000 m<sup>2</sup>, were successfully produced using the developed technique.

In the concluding step of the study, our aim was to showcase the potential application of the produced materials in the fabrication of energy storage devices. Therefore, the synthesized tin- and antimony-based porous materials were integrated as active components in anodes of sodium- and potassium-ion batteries since Sn and Sb are commonly known as alloying-type anode materials. Through the utilization of our materials, we achieved favorable cycling stability (91% after 50 cycles) and capacities up to 353 mAh/g, with an initial fading observed in the first 10 cycles at a C/20 rate.

In summary, we have introduced a novel and versatile template-free method for the synthesis of metal- and metalloid-based porous materials. For the first time, we utilized NaK-78 emulsions as sacrificial templates to generate hollow nanostructured materials with customizable porosity, shape, and composition. Our research demonstrates that NaK serves as a multifunctional agent for chemical reduction, structure directing, and pore formation processes concurrently. The proposed method is simple, scalable, and highly variable, making it suitable for many applications, including energy storage, and catalysis.

[1] *Nat. Mater.*, **2021**, 20, 1179

[2] *Adv. Mater.*, **2020**, 32, 2002780

[3] *Chem. Mater.*, **2021**, 33, 1571

[4] *Chem. Commun.*, **2023**, 59, 10928

[5] *J. Mater. Chem. A*, **2022**, 10, 22955

## Acknowledgements

This work was supported by the Russian Science Foundation (project No 24-23-00270).

# HIGHLY EFFICIENT LASER-INDUCED SYNTHESIS OF ELECTRODE MATERIALS FROM DEEP EUTECTIC SOLVENTS FOR BIOGENIC AMINE DETERMINATION

*Levshakova A.A.<sup>1</sup>, Khairullina E.M.<sup>1</sup>, Ninayan R.G.<sup>1</sup>, Popov A.Yu.<sup>1</sup>, Kalinichev A.A.<sup>2</sup>, Manshina A.A.<sup>1</sup>*

<sup>1</sup> St. Petersburg State University, St. Petersburg, Russia

<sup>2</sup> Center for Optical and Laser Materials Research, St. Petersburg University, St. Petersburg  
[sashkeens@gmail.com](mailto:sashkeens@gmail.com)

Food safety and quality control during transport and storage are major challenges for the fish industry. After fish death, biodegradation of tissues occurs, which is accompanied by the release of a number of specific chemical compounds that are considered biomarkers of fish spoilage, primarily biogenic amines [1].

The main methods used to assess the level of fish spoilage and to determine the concentration of harmful contaminants in fish are usually liquid and gas chromatography and mass spectrometry. These approaches have many disadvantages, such as the complexity of rapid analysis, the need for expensive equipment and highly qualified specialists [2]. Therefore, the development of more efficient and economically feasible technological solutions and approaches to implement sensor platforms for rapid qualitative and quantitative analysis of the quality and freshness of fish products is an extremely important task [3].

In this paper, a fast and efficient electrode fabrication approach is proposed for the development of electrochemical sensors for the detection of biogenic amines. It is based on the laser-induced deposition of metallic nanostructured materials from deep eutectic solvent systems. This method allows to obtain structures with a developed surface of a given geometry on different surfaces at a rate 500 times higher than from aqueous solutions [4]. This work presents the laser synthesis of metal electrodes (Fig. 1a), their comprehensive characterization and their electrochemical analysis to study their sensory response to biogenic amines using cyclic voltammetry, chronoamperometry and differential pulse voltammetry methods (Fig. 1b).

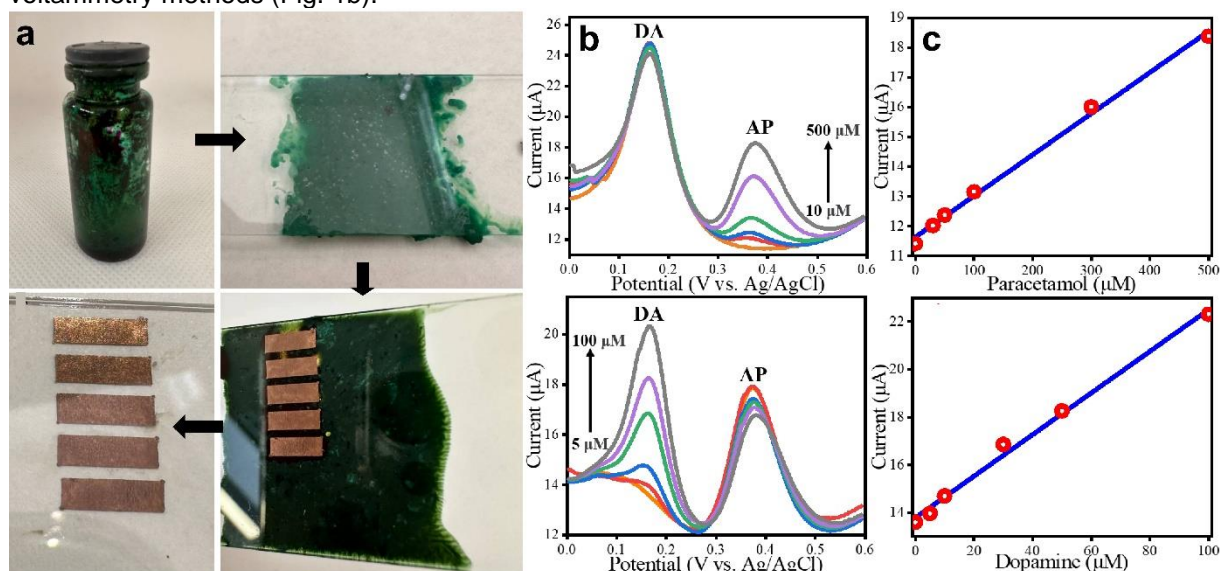

**Figure 1.** (a) Photos of the stages of laser synthesis from DES, (b) DPVs of Ni patterns recorded in solutions containing dopamine (DA) and acetaminophen (AP), (c) The linear dependences of the analytical signal on the concentration of AP and DA.

## References

- [1] *Int. J. Food Microbiol.*, **1996**, vol. 33, no. 1.
- [2] *Trends in Food Science and Technology*, **1997**, vol. 8, no. 8.
- [3] *Trends in Food Science and Technology*, **2021**, vol. 112, no. 5.
- [4] *New J. Chem.*, **2021**, 45, 21896–21904

## Acknowledgements

This work was supported by the Russian Science Foundation (project No 24-19-00541). The authors also express their gratitude to the SPbSU Nano-technology Centre, the Centre for Optical and Laser Materials Research and the Centre for X-ray Diffraction Studies.

# CHIRAL PLASMONIC NANOCRESCENTS FOR SENSING: SYNTHESIS AND OPTICAL PROPERTIES

*Lobanova E.M.<sup>1</sup>, Bochenkov V.E.<sup>1</sup>, Bahratov I.A.<sup>2</sup>*

<sup>1</sup> Moscow State University, Chemical Department, Moscow, Russia

<sup>2</sup> Valiev Institute of Physics and Technology of Russian Academy of Sciences, Moscow, Russia  
Postgraduate, Junior Researcher  
[katerina.m.lobanova@gmail.com](mailto:katerina.m.lobanova@gmail.com)

Nanomaterials based on plasmonic metal nanoparticles have great potential for medicine, pharmaceuticals and sensors. Their unique optical properties are due to the enhancement of local near fields under the influence of external electromagnetic waves upon the excitation of plasmon resonance. The optical properties of such nanomaterials depend on the characteristics of the nanoparticles: shape, size, material [1]. Therefore, the development of methods for the formation of new nanoparticles with a given shape is an urgent task. The plasmon resonance effect can be especially useful for studying the optical properties of chiral molecules, since they give very weak chiroptical signals due to the difference between molecular sizes and the wavelength of incident light [2]. One of the main methods for studying chiral molecules is circular dichroism spectroscopy (CD). It can be expected that in the field of chiral plasmonic nanoparticles, the CD signal of chiral molecules will also be enhanced.

The authors achieved the formation of chiral plasmonic silver nanocrescents using a combination of colloidal lithography and ion-plasma sputtering methods. The new technique makes it possible to obtain chiral nanocrescents of various orientations and widths by controlling the angles of deposition and sputtering (Scheme 1).

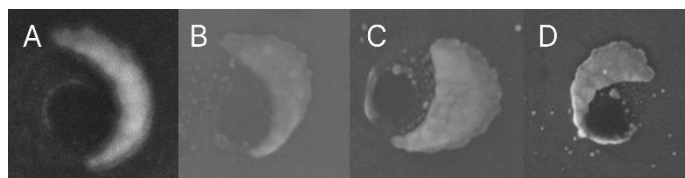

**Scheme 1.** SEM of chiral plasmonic nanocrescents of varying widths

It was shown that the resulting nanoparticles are characterized by enhanced absorption and a CD signal in the visible and near-IR region.

To sum up, a new formation method provides a rapid and inexpensive way of forming chiral nanocrescents. Along with the techniques commonly used to measure the optical properties of metal nanoparticles (extinction and fluorescence spectroscopy), we anticipate that CD will play an important role due to the number of effective ways it can be used to detect interactions between biomolecules and chiral plasmonic systems. Broader research is also needed to determine the relationship of crescent asymmetry with the CD signal and how to integrate such surfaces into functional commercial devices.

## References

- [1] Maier S.A. *Plasmonics: Fundamentals and Applications* / New York, NY: Springer 2007
- [2] Paiva-Marques W.A. et al. Chiral plasmonics and their potential for point-of-care biosensing applications // *Sensors (Switzerland)*. MDPI AG 2020. 20(3). 944-963

## Acknowledgements

This work was supported by the Russian Science Foundation (22-13-00126).

## MAGNETIC CILIA PLATFORM FOR PH SENSING BY FLEXIBLE SENSOR

*Lyashchuk V.K.<sup>1</sup>, Kladko D.V.<sup>1</sup>*

<sup>1</sup>ITMO University, St. Petersburg, Russia

Student

[lyaschuk@scamt-itmo.ru](mailto:lyaschuk@scamt-itmo.ru)

pH value (hydrogen ion activity) is a very important chemical and biochemical property in many fields of science and industry sectors, such as medicine, biology, agriculture, environmental monitoring, etc. For example, the pH value of water is a significant parameter for aquatic animals and plants, which can only survive in the framework of the exact pH values or in an acidic or alkaline environment [1]. Flexible sensors are able to control changes of pH in small quantities of test samples, which is explained by microsizes of such systems. Thus, there is a demand for simultaneously manipulation and measurement of small amounts of analyte. The most appropriate option is to use magnetic cilia, which are actuated by using an external magnetic field. This has a number of advantages: it does not require any mechanical connection from the artificial cilia to the external source, flexible magnetic artificial cilia can be made using low-cost materials and techniques and most microfluidic components, cells and chemicals do not interact with magnetic fields, making it possible to treat magnetic artificial cilia and their external actuators as an auxiliary system, and providing a level of freedom in designing and integration of artificial cilia into an application environment [2].

In this study have been investigated the potentiometric graphene-based sensor for pH measurement integrated with magnetic cilia platform. The fabrication of the sensor starts with a preparation of PET (polyethylene terephthalate) flexible substrate and making a required two-electrode pattern using a laser engraver. Further, the Ag/AgCl paste applied on the pattern to make electrodes with good conductivity [3, 4]. One of the electrodes is covered with graphene paste with mass ratio graphene: PDMS=3/7. To complete a working electrode, graphene dispersion is deposited onto the surface of graphene paste. Polyvinyl pyrrolidone (PVP) is introduced as a dispersant to separate sheets for its conjugated structure with the same  $\pi$ - $\pi$  bond like graphene. The structure of dispersion was checked using a scanning electron microscope (SEM). The conductive tracks were then coated with PDMS (polydimethylsiloxane) to protect the electrodes from water. The pH sensor was tested in a water solution with different concentrations of H<sup>+</sup> ions. The pH sensor showed an excellent sensitivity of about 23 mV/ph. The recovery time was about 10s. The magnetic cilia was integrated to make the pH measurement in a controllable and automated manner. The fabrication of the magnetic cilia includes preparation of the magnetic ink (NdFeB particle and PDMS with mass ratio=3/7) and making a mold with 3D printing technology [2]. The magnetic control of cilia was quantified by 3D Helmholtz coil in a wide range of amplitude and frequency of magnetic field.

The pH sensor with good sensitivity and response time was received. It was integrated with magnetic cilia to make the process of measurement more convenient and automated. It is planning to optimize the sensor to increase sensitivity. We believe that integration of magnetic cilia will be beneficial for creation of the automated mini-lab for study of the properties of biological liquids.

### References

- [1] Goran S., Tijana K., Milan R., Dragana V., Sanja P., Vladimir S., Jelena C. Flexible sensors based on two conductive electrodes and MWCNTs coating for efficient pH value measurement // *Journal of Alloys and Compounds*. **2019**, 794, 76-83.
- [2] Tanveer ul I., Ye W., Ishu A., Zhiwei C., Hossein E.A., Hemanshu G., Roel K., Bhavana B. V., Tongsheng W., Shuaizhong Z., Patrick R. O., Jaap M. J. den T. Microscopic artificial cilia – a review // *Lab on a chip*. **2022**, 9, 1650-1679.
- [3] Hong J.P., Jo H.Y., Kyoung G. L., Bong G.C. Potentiometric performance of flexible pH sensor based on polyaniline nanofiber arrays // *Nano Convergence*. **2019**, 6.
- [4] Vivaldi F., Bonini A., Melai B., Poma N., Kirchhain A., Santalucia D., Salvo P., Di Francesco F. A graphene-based pH sensor on paper for human plasma and seawater // 41st Annual International Conference of the IEEE Engineering in Medicine and Biology Society (EMBC). **2019**.

### Acknowledgements

The work was financially supported by the Russian Science Foundation no. 23-23-00334.

## GREEN SYNTHESIS OF SILVER NANOPARTICLES AND CRYOFORMATION OF THEIR HYBRID NANOSYSTEMS WITH DIOXIDINE

*Makeeva A.A.*<sup>1</sup>, *Vernaya O.I.*<sup>1,2</sup>, *Semenov A.M.*<sup>3</sup>, *Shabatina T.I.*<sup>1,2</sup>

<sup>1</sup>Lomonosov Moscow State University, Chemistry Department, Moscow, Russia

<sup>2</sup>Bauman Moscow State Technical University, Moscow, Russia

<sup>3</sup>Lomonosov Moscow State University, Biology Department, Moscow, Russia

[alinka.mak04@yandex.ru](mailto:alinka.mak04@yandex.ru)

Currently, the widespread and not always justified use of antibiotics has led to the emergence and increase in the number of bacteria resistant to antimicrobial drugs. The creation of new antibacterial dosage forms requires long-term time and financial costs for obtaining new compounds, their characterization and testing *in vitro* and *in vivo*. One of the promising approaches to solve this problem is the simultaneous use of inorganic nanoparticles of compounds with a pronounced bactericidal effect, as well as their combination with antibacterial drugs. Silver nanoparticles are optimal in terms of the ratio of antibacterial activity and cost.

Recently, methods of green chemistry and green synthesis have been actively developed. This direction is associated with the use of environmentally friendly renewable natural resources, such as plant extracts, in the production of materials. Silver nanoparticles are obtained using extracts of aloe vera, green tea, rosemary and other representatives of the flora exotic to our region. Aqueous extracts of medicinal herbs such as chamomile, calendula, and oak bark are actively used as rinses in the treatment of otorhinolaryngological diseases. Colloidal silver-based drugs are also used for bacterial sinusitis: collargol and protargol.

In this work, plant extracts and silver nanoparticles were combined. Aqueous extracts of medicinal plants are reducing agents, stabilizers of silver nanoparticles, and are also active components in the formed systems. To confirm the presence of silver nanoparticles in the resulting systems and establish their size parameters, methods of X-ray phase analysis, UV spectroscopy and dynamic light scattering were used. The composition of the organic component was characterized by UV and IR spectroscopy. The average size of the resulting silver nanoparticles was 30-60 nanometers, depending on the nature of the reducing agent extract, but did not depend on the concentration of precursors. During the work, the optimal conditions for the formation of colloidal solutions were determined. The resulting systems were active against *E. coli* and *S. aureus*, in contrast to plant extracts.

The resulting nanoparticles were included in the particles of the antibacterial drug dioxidin using cryochemical modification. This method makes it possible to obtain hybrid nanosystems with a size of 50-400 nm, which are particles of the drug substance inside and on the surface of which there are inorganic nanoparticles whose size corresponds to the size of the particles in the original colloidal precursor solution.

### **Acknowledgements**

The work was carried out within the framework of the state assignment of M.V. Lomonosov Moscow State University, topic No AAAA-A21-121011590090-7.

## INVESTIGATION OF THE PERMEABILITY OF PAINT COATINGS FILLED WITH BASALT PRODUCTION WASTE

*Maliavina Y.M.<sup>1</sup>, Silaeva A.A.<sup>1</sup>, Romakhina T.R.<sup>1</sup>, Kukushkina E.A.<sup>1</sup>, Snimshchikova Y.O.<sup>1</sup>, Rodnikov D.T.<sup>1</sup>*

<sup>1</sup>D.I. Mendeleev University of Chemical Technology of Russia, Moscow, Russia  
Graduate student  
[jonkey.moa@yandex.ru](mailto:jonkey.moa@yandex.ru)

The protection of large-sized metal structures operated under atmospheric conditions is mainly carried out using protective paint and varnish materials [1]. Such compositions should prevent the diffusion of aggressive media, in particular water, to the metal substrate in order to protect it from corrosion. Thus, the permeability of paint coatings is one of the key factors determining the protective properties of such coatings [2].

In addition to the main components of the paint and varnish material, such as a film-forming substance and pigments, fillers are introduced into the composition of such materials in order to reduce the cost of the composition. Recently, waste from various industries has been increasingly used as fillers. The use of such waste is aimed not only at reducing the harmful effects on the environment, but also at giving the paint composition special properties [3].

This work is devoted to the study of the effect of mineral filler, waste from basalt production, on the permeability of paint coatings. The results of the conducted studies show that the introduction of the filler under study does not lead to a decrease in the physical and mechanical characteristics of the paintwork, there is an improvement in protective properties with a decrease in the permeability of coatings based on polyurethane and epoxy based with an optimal ratio of fillers. Microtalk, zinc phosphate and barium sulfate were also present in the compositions, which were partially replaced by the filler under study. Previously, the effect of another filler of a similar nature on the permeability of polyurethane and epoxy coatings was investigated. The results of the study showed the influence of basalt filler on the curing processes, leading to an increase in the degree of curing and a decrease in the permeability of coatings. The purpose of this work was to confirm the results obtained by examining another basalt filler.

To assess the possible effect of basalt filler on the permeability of the paintwork, the acid-base properties of its surface were evaluated by potentiometric titration. Determination of the content of acid-base centers is based on the use of the method of potentiometric titration of the suspension of the filler under study with aqueous solutions of p-toluene sulfonic acid and caustic potassium. Since the operation of the pH meter is based on measuring the electromotive force created by the electrochemical part of the device (electrodes), titration, in which a change in the pH of the suspension is recorded when a titrant is added, refers to potentiometric methods. Titration results showed the presence of the main centers on the filler surface in the amount of 97,28 mmol/g. The effect of the basalt filler content on the degree of curing of coatings by the gel-sol fraction method was also studied. The method for determining the degree of curing of coatings based on the content of the gel-sol fraction in the film is based on the ability of the soluble part of the films (sol fraction) to be washed out with a solvent during extraction in a Soxhlet apparatus. The method consists in the quantitative determination of a sol fraction that is not bound into a three-dimensional polymer grid (gel fraction). Based on the results obtained, it can be concluded that the introduction of a basalt filler affects the degree of curing of coatings, which, in turn, may affect permeability.

### References

- [1] Drinberg, A.S., Itsko E.F., Kalinskaya T.V. Antikorrozionnye gruntovki [Anticorrosive primers]. Saint Petersburg, NIPROINS LKM and P with OP, 2006, 168 p.
- [2] Reitlinger S.A. Pronitsaemost' polimernykh materialov [Permeability of polymer materials]. Moscow, Chemistry, 1974, 270 p.
- [3] Kovrizhkina N.A., Kuznetsova V.A., Silaeva A.A., Marchenko S.A. Sposoby uluchsheniya svoystv lakokrasochnykh pokrytii s pomoshchyu vvedeniya razlichnykh napolnitelei (obzor) [Ways to improve the properties of paint coatings by introducing various fillers] (review). Aviatsyonnye materialy i tekhnologii, 2019, no. 4 (57), pp. 41-48.

## BOEHMITE NANOPARTICLES-BASED MATERIAL AS A SORBENT FOR TETRACYCLINE ANTIBIOTICS UTILIZATION FROM WASTEWATER

*Markarian A.A.<sup>1</sup>, Podurets A.A.<sup>2</sup>, Voznesenskiy M.A.<sup>2</sup>; Bobrysheva N.P.<sup>2</sup>, Osmolowsky M.G.<sup>2</sup>, Osmolovskaya O.M.<sup>2</sup>, Sokolov I.A.<sup>1</sup>*

<sup>1</sup> Peter the Great St. Petersburg Polytechnic University, St. Petersburg, Russia

<sup>2</sup> St. Petersburg State University, St. Petersburg, Russia

PhD Student

[art.markarian@mail.ru](mailto:art.markarian@mail.ru)

The development of industry in recent decades has not only improved people's lives by making them more comfortable but has also led to the problem of water contamination [1]. Industrial activities on a large-scale result in the production of numerous unnatural substances and materials that can have unpredictable consequences when they find their way into water, air, or soil. One of the most dangerous water pollutants are antibiotics [2], which are extensively used not only for medical purposes but also in agriculture. The presence of antibiotics in water can lead to bacteria mutations and the development of resistance to many of them.

Tetracyclines, which are broad-spectrum antibiotics commonly used to treat various infections, have become widespread in animal husbandry due to their effectiveness and low cost [3]. As a result, residues of these drugs end up in wastewater through animal urine, posing significant threats to human health and ecosystems.

As a way utilization of the pollutant after its separation from wastewater, one can use the process of photodegradation - the destruction of molecules under the light. The second option is desorption with a smaller amount of solvent. This method allows to concentrate the pollutant for its further disposal.

It is clear an efficient way to extract these contaminants from aquatic environments is needed. In this work we propose to use boehmite ( $\gamma$ -AlOOH) as such a substance. It is not-toxic and can be obtained on an industrial scale, which makes it a promising sorbent for wastewater treatment.

Boehmite nanoparticles were obtained by a hydrothermal method using aluminum nitrate and sodium hydroxide. All samples were fully characterized by XRD, TEM, IR and SSA was obtained using BET method. Based on the experiments performed, the activation energies of particle growth were calculated.

Sorption and desorption experiments were held for 3 tetracycline antibiotics: oxytetracycline, tetracycline and chlortetracycline. Experiment parameters like time, solvent pH and concentrations were optimized. Spectrophotometry was used for preliminary experiments and HPLC was chosen for quotative analysis of model solutions and real wastewater.

As different crystallographic modifications of Al<sub>2</sub>O<sub>3</sub> are widely used as a sorbent, some of the samples were calcined to establish their properties. It was shown that the optimal sample S240\_500 allows removing 90% of antibiotics from the solution, and also a high degree of elution is achieved for it, which indicates the possibility of its regeneration. A sorbent was tested to remove the antibiotics described above from real wastewater taken in the centre of St. Petersburg, and high results of pollutant sorption were shown.

### References

- [1] *Frontiers in Environmental Science* **2022**, 10, 1
- [2] *Sci Total Environ.* **2019**, 690, 1068
- [3] *J Anal Methods Chem.* **2017**, 2017, 1

### Acknowledgements

This Data was given by Centre for Optical and Laser Materials Research, Research Centre for X-ray Diffraction Studies, Chemical Analysis and Materials Research Centre, Geomodel and Centre for Innovative Technologies of Composite Nanomaterials of Saint Petersburg State University

## PROPERTIES OF NANOCOMPOSITE MATERIALS BASED ON POLYSACCHARIDES

*Maslennikova M.S., Zarubin D.M., Kachalova E.A., Salomatina E.V., Smirnova L.A.*

Nizhny Novgorod State University named after. N.I. Lobachevsky, Nizhny Novgorod, Russia  
Student

[masrita1414@gmail.com](mailto:masrita1414@gmail.com)

Recently, one of the most serious environmental problems has been a sharp increase in the amount of non-recyclable waste from polymer materials. According to 2021 data from Plastics Europe, about 44% of plastic is used as packaging material. [1] They are most widely used in the food industry for long-term storage of products. The use of disposable packaging and personal protective equipment makes a significant contribution to the deterioration of the environmental situation, especially during the Covid-19 pandemic. One of the possible ways to reduce the burden on the environment is to create biodegradable packaging materials based on natural substances. Promising materials for this purpose are polysaccharides, such as starch (ST) and chitosan (CTS), due to their biocompatibility and the availability of raw materials.

In order to be able to create a material from ST combined with CTS, the original polysaccharides were modified, since CR is soluble in alkaline media, and CTS in acidic media. Modification of ST was carried out by graft polymerization with acrylamide (AA) and CTS treatment with enanthaldehyde (EA) to form Schiff bases. The conditions for combining modified CTS with ST in aqueous acid solutions in a mass ratio of 1 to 2 and 1 to 3, respectively, have been worked out. In order to increase mechanical properties and bactericidal properties, nanoparticles of titanium dioxide (TiO<sub>2</sub>) up to 5wt% relative to polysaccharides were introduced into the composition. Film samples were obtained using the casting method. The structure of the compositions was studied using IR spectroscopy, scanning electron microscopy and X-ray phase analysis.

Introduction of nanoparticles TiO<sub>2</sub> helps to increase the strength characteristics of film materials based on polysaccharides. The dependence is extreme, the best indicators are observed when content of 2wt.% TiO<sub>2</sub> relative to the mass of CTS and ST:AA. The highest value of the tensile strength of the films was 26.2 MPa and at a deformation of 8.1%, which is 3.2 times higher than that of the sample that does not contain nanoparticles. It should be noted that despite satisfactory tensile strength characteristics, they turned out to be brittle in bending. Therefore, the films were additionally modified with a plasticizer, which was glycerol (GL).

The introduction of GL led to an increase in bending elasticity. The best results were shown by films containing 25wt.% GL and 2wt.% nanoparticles TiO<sub>2</sub>. Surprisingly, it turned out that the introduction of GL does not lead to a decrease in tensile strength compared to a composition that contains only nanoparticles. The strength of the films reaches 30 MPa, the deformation increases to 12wt.%, which exceeds the corresponding indicators of films based on modified ST presented in the literature - 15 MPa and synthetic packaging materials - 22 MPa.

In addition, the permeability of nitrogen, oxygen and carbon dioxide of the synthesized films was studied. For films based on ST:AA-CTS-EA in a ratio of 2 to 1, the permeability for N<sub>2</sub> is 0.013 Barrer, for O<sub>2</sub> – 0.019 Barrer, for CO<sub>2</sub> – 0.41 Barrer. The permeability values show that the resulting films are medium barrier, and the barrier properties with respect to oxygen are superior to the main polymers (PET, LDPE, BOPP, etc.) used as packaging materials. The introduction of TiO<sub>2</sub> nanoparticles does not affect the permeability of the films.

### References

[1] *Plastics Europe. Plastics – the Facts 2022*

### Acknowledgements

This work was supported by the Russian Science Foundation (grant No. 23-74-10069).



# PREPARATION OF NANOCOMPOSITES BASED ON EXFOLIATED ORGANIC-INORGANIC DERIVATIVES OF LAYERED DOUBLE HYDROXIDES AND LAYERED PEROVSKITE-LIKE OXIDES

*Matsenko R.O.<sup>1</sup>, Silyukov O. I.<sup>1</sup>, Kurnosenko S.A.<sup>1</sup>*

<sup>1</sup> St. Petersburg State University, St. Petersburg, Russia

Student

[st092192@student.spbu.ru](mailto:st092192@student.spbu.ru)

Some crystals don't bond in three dimensions. Layered crystals, for instance, have strong bonds within planes but weaker bonds between planes. This property enables them to be peeled apart into nanosheets, which are thin sheets, micrometers wide but less than a nanometer thick. This process yields materials with incredibly high surface areas, over 1000 square meters per gram, enhancing their surface activity significantly. This characteristic finds applications in various fields, like serving as electrodes in supercapacitors or batteries [1]. Also, nanolayers can be used to synthesize new, composite nanomaterials based on the reassembly process. In particular, layer-by-layer assembly of LDH nanosheets with other 2D materials has emerged as a widely employed strategy to preserve the nanosheet structure and ensure synergistic performance.

The first stage of the work involved the development of a method for the synthesis of layered double hydroxides (LDH) and layered perovskite-like oxides (LPLO) intercalated with surfactant molecules. We selected 3 layered hydroxides: Mg<sub>2</sub>Al-LDH, Ni<sub>2</sub>Al-LDH, Co<sub>2</sub>Al-LDH and 3 layered perovskite-like oxides: KCa<sub>2</sub>Nb<sub>3</sub>O<sub>10</sub>, CsCa<sub>2</sub>Ta<sub>3</sub>O<sub>10</sub> and K<sub>2</sub>La<sub>2</sub>Ti<sub>3</sub>O<sub>10</sub>. The precursors of organic-inorganic LDH derivatives were synthesized by a hydrothermal method to maintain maximum crystallinity and contained a carbonate anion in the interlayer space [2]. Next, a technique was developed for the preparation of nitrate derivatives of LDH by the anion exchange method. This stage is required to replace the more stable carbonate anion with the less stable nitrate anion, to facilitate the subsequent introduction of surfactants. For all nitrate hydroxide derivatives, organic derivatives containing pentanoate, octanoate and dodecyl sulfate anions in the interlayer space were obtained. The interlayer distances for the LDH data were 17, 21 and 25 Å, respectively, which indicates the arrangement of surfactant molecules in the form of a monolayer in the case of this synthesis procedure. The precursors of organic-inorganic perovskite-like oxides were synthesized by classical ceramic method. After this, protonated forms of layered oxides were synthesized by mixing the original alkaline form in a strong acid solution. The protonated form has been used to prepare organic derivatives of layered perovskite-like oxides with butylamine, octylamine, and dodecylamine in the interlayer space. All samples were fully characterized by XRD, SEM, IR and Raman spectroscopy, TGA and CHN-analysis.

The second part of the work is to develop a technique for exfoliation and retaking of all obtained organic derivatives in a non-polar solvent. The use of nonpolar solvent is due to the opposite charges of oxide and hydroxide nanosheets. Oppositely charged nanolayers in stable suspensions in non-polar solvents, being attracted to each other, are capable of forming a new composite material in which layers of oxide and hydroxide alternate with each other. In this work, we report for the first time the possibility of decomposition of layered perovskite-like oxides in a non-polar environment, as well as the preparation of nanocomposites based on nanolayers of layered double hydroxides and layered perovskite-like oxides.

## References

1. Nicolosi V. et al. Liquid exfoliation of layered materials // *Science*. 2013. Vol. 340, № 6139. P. 72–75.
2. Miyata S. Anion-exchange properties of hydrotalcite-like compounds. 1983. Vol. 31, № 4. P. 305–311.

## Acknowledgements

This work was supported by the Russian Science Foundation (project No 22-73-10110). Scientific research was performed using the equipment of the Research Park of St. Petersburg State University (Centre for X-ray Diffraction Studies, Chemical Analysis and Materials Research Centre, Centre for Innovative Technologies of Composite Nanomaterials, Centre for Optical and Laser Materials Research, Centre for Magnetic Resonance).

## EXPLORING DAST MICROCRYSTALS: ADVANCES IN OPTICAL MATERIALS SCIENCE

*Mediantsev E.S.<sup>1,2</sup>, Lobova N.A.<sup>1,2</sup>, Ivanov I.I.<sup>1</sup>*

<sup>1</sup> NRC «Kurchatov Institute», Moscow, Russia

<sup>2</sup> Moscow Institute of Physics and Technology, Dolgoprudny, Russia

PhD Student

[evgenkupffer@gmail.com](mailto:evgenkupffer@gmail.com)

The study investigates the nonlinear optical properties of microcrystalline powders of the DAST dye and its supramolecular complexes, presenting a novel approach to optical materials science. Traditionally, the exploration of nonlinear optical phenomena has heavily relied on single crystals, which are often challenging and time-consuming to grow. However, this research proposes the utilization of microcrystals as a viable alternative. The primary aim is to demonstrate the applicability of this method and elucidate the optical behavior of the system.

The use of microcrystals offers several advantages over single crystals, including simpler synthesis processes and enhanced versatility in experimental setups. Through comprehensive spectroscopic analysis and theoretical modeling, the study elucidates the nonlinear optical response of DAST microcrystals and their supramolecular complexes. Notably, the research showcases the feasibility of employing microcrystalline powders in diverse optical applications, ranging from nonlinear frequency conversion to optical switching and modulation.

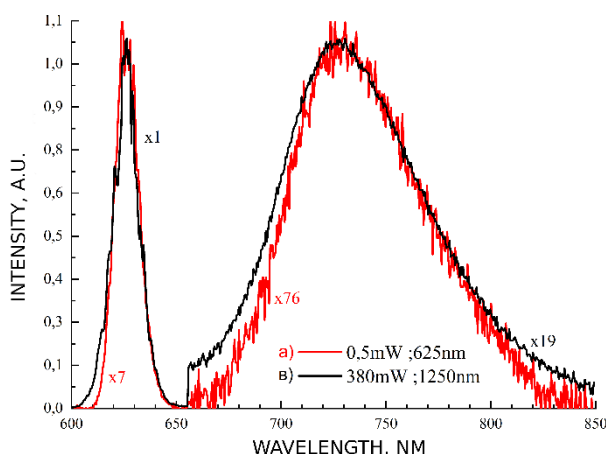

**Figure 1.** Second harmonic generation and cascade excitation of luminescence in crystalline powder DAST

Furthermore, the findings underscore the potential of microcrystalline DAST as a promising candidate for the development of advanced photonic devices and integrated optical circuits. By harnessing the unique optical properties of these microscale structures, researchers can explore new avenues in optical materials science and pave the way for innovative technologies with applications in telecommunications, biophotonics, and beyond. Overall, this work contributes to expanding the scope of nonlinear optics and highlights the significance of microcrystal-based approaches in advancing the field of optical materials science.

### References

[1] J. Phys. D: Appl. Phys. **2019**, 52, 433001.

[2] RSC Adv. **2020**, 10, 37, 22273-22283.

### Acknowledgements

The work was carried out as part of a state assignment of NRC «Kurchatov Institute»

# LONG-TERM ADSORPTION STORAGE OF LIQUEFIED NATURAL GAS VAPORS BASED ON THE CAPILLARY CONDENSATION EFFECT IN NOVEL MICRO-MESOPOROUS CARBON COMPOSITES

*Menshchikov I.E.<sup>1</sup>, A.E. Grinchenko<sup>1</sup>, I.D. Shelyakin<sup>1</sup>, S.S. Chugaev<sup>1</sup>, Shkolin A.V.<sup>1</sup>*

<sup>1</sup> A.N. Frumkin Institute of physical chemistry and electrochemistry of the Russian academy of sciences, Moscow, Russia  
Lead researcher, Deputy Head of the R&D center, PhD  
[i.menshchikov@phych.ac.ru](mailto:i.menshchikov@phych.ac.ru)

Liquefied natural gas (LNG) is one of the most important and reliable energy carriers; it possesses high energy capacity, eco-friendliness and excellent logistics capabilities. However, its storage in a cryogenic state (at a temperature of ~ 111 K) requires special techniques to protect from boil-off gases (BOG), which emerge due to external heat flow inside a cryogenic vessel or during the refueling process. BOGs are usually released into the atmosphere via protective valves or simply burned if their rational utilization or recovery is impossible, leading to the loss of valuable energy resource and strengthening the greenhouse effect. In this regard, the development of new methods for the LNG vapors capture and storage is an issue of scientific and practical interest.

Adsorption-based capture and storage of the LNG vapors (ALNG) is a promising method for improving cryogenic methane storage systems [1]. One of the key objectives in this area is searching efficient highly-porous materials, such as metal-organic frameworks and microporous carbon adsorbents. However further improvement of the ALNG capacity can be achieved using the capillary condensation effect in mesopores at subcritical temperatures.

In the present study, the molecular dynamics (MD) calculations and the Dubinin theory of volume filling of micropores (TVFM) were used for optimizing the parameters of micro- and mesoporosity of new adsorbents intended for the ALNG technology. The results of theoretical modeling were used for designing the synthesis routes for preparing novel adsorption materials with a tailored micro- and mesopore structure from various precursors. The textural properties of the adsorbents were investigated by x-ray diffraction, scanning electron microscopy, and low-temperature nitrogen adsorption and other methods.

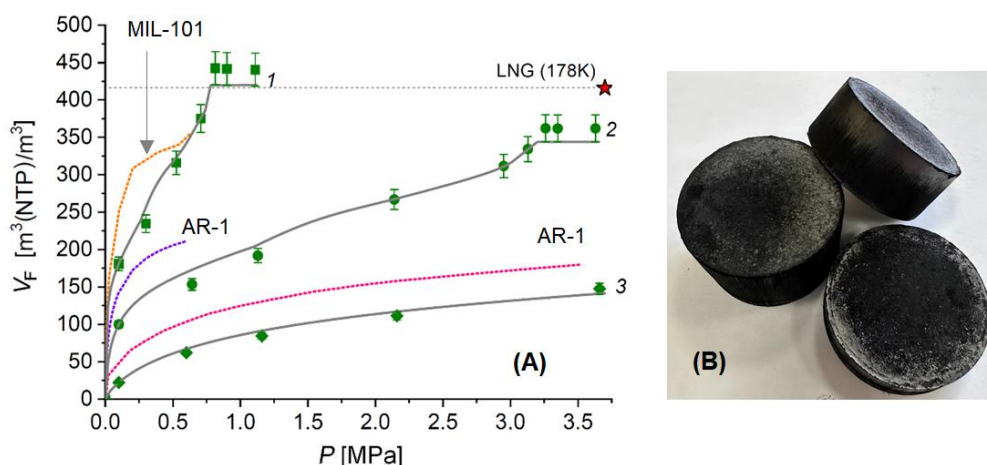

**Scheme 1.** Values of the total volumetric capacity  $V_F$  of the ALNG system (A) loaded with designed micro-mesoporous carbon composites (B) compared to the best samples of carbon adsorbents (AR-1) and MOF (MIL-101) at temperatures: 1 – 143, 2 – 178 and 3 – 243 K.

Methane adsorption on novel adsorbents and was measured experimentally in the range of temperatures of 112–333 K and pressures from 5 Pa to 5 MPa using a custom-made adsorption unit. It was found that the capillary condensation of methane in mesopores ensured an extraordinary adsorption capacity of new composites, over 400 m<sup>3</sup>(NTP)/m<sup>3</sup>, which exceeds all known achievements in this area of research.

## References

[1] *Adsorption* **2023**, 29, 255

## Acknowledgements

This work was supported by the Russian Science Foundation (project No 22-73-00184).

## THE CONTROL OF ZnO ORIENTED ATTACHMENT PROCESSES AS A TOOL FOR REGULATING ITS PHOTOCATALYTIC ACTIVITY

*Meshina K.I.<sup>1</sup>, Barabanov N.M.<sup>1</sup>, Tkachenko D.S.<sup>1</sup>, Bobrysheva N.P.<sup>1</sup>, Osmolovsky M.G.<sup>1</sup>,  
Voznesensky M.A.<sup>1</sup>, Osmolovskaya O.M.<sup>1</sup>*

<sup>1</sup> St. Petersburg State University, St. Petersburg, Russia  
Student, undergraduate degree  
[kmeshina040301@gmail.com](mailto:kmeshina040301@gmail.com)

Due to its antibacterial properties and non-toxicity, zinc oxide is engaged in the cosmetic industry (foundation creams, sunscreens) and medicine. Besides, a new urgent task is the use of zinc oxide as a photocatalyst for the decomposition of cyclic organic compounds that polluting wastewaters. Being a semiconductor, ZnO can be used for photodegradation of molecules, but there is a problem of creating an effective catalyst.

To solve this issue, it is worth referring to the fact that a feature of zinc oxide is the rapid course of the process of oriented attachment (OA) during synthesis. This topic has hardly been studied and opens up a lot of possibilities for regulating the structural and functional properties of ZnO.

In this work, based on our understanding of the OA process, counterions were used in the synthesis of ZnO nanoparticles, since this is the most easily adjustable parameter in the control of OA. Sulfate anion and nitrate anion were utilized as counterions. It is worth noting that there is a certain minimum in the form of structural blocks (hereinafter referred to as blocks), which are able to assemble in different ways into larger structures (nanorods, plates, flowers, etc.). In addition, during the synthesis, the holding time of the reaction mixture (0 and 90 min) and the order of reagents injection (SEQ – separately and SIM – simultaneously) were varied. The obtained samples were characterized by XRD, FTIR, SEM, SSA, XPS, Raman spectra, absorption and reflection spectra.

It was found out that the use of sulfate anions as counterions leads to the appearance of an additional phase of zinc hydroxide, therefore, zinc oxide nanoparticles obtained in cases of nitrate application were used for subsequent studies. The characterization also showed the presence of defects and oxygen vacancies in the ZnO structure.

Quantum chemical calculation methods were used to calculate the band structure of the samples, the interaction of the blocks with each other and the interaction of the surface of the blocks with ions present in the reaction mixture. Calculations revealed that the band gap energy corresponds to that obtained experimentally by constructing absorption spectra in Tauc plot. Moreover, it has been demonstrated that the most effective interaction is between blocks which surfaces are expressed by faces (0 0 1), while other faces (1 0 0) are “closed” to interaction because of adsorbed ions.

It is noteworthy, the OA process depends on which blocks are present in the reaction medium. In order to change the blocks and their varying connections, two procedures SIM and SEQ were used. Additionally, data analysis showed that holding the reaction medium for 90 min practically does not change the structural parameters of nanoparticles, which leads to the conclusion that the processes of block formation occurs directly while gaining the particles. The SEM data show the formation of grouped nanorods and flower-like structures using zinc sulfate. As for the use of the nitrate anion as a counterion, the formation of flowery clusters of nanoparticles in the case of the SIM procedure and nanoplates of the SEQ procedure was observed.

Photocatalytic activity was screened for four samples: ZnO particles were kept for 30, 60 and 90 minutes in a methylene blue (MB) dye solution, considered as a model of wastewater, under the visible light radiation. The optimal sample turned out to be the one that was synthesized by the SEQ procedure using nitrate ions. The high efficiency of photodegradation is explained by the fact that this sample has a more accessible face (0 0 1) due to the assembly of blocks, which decomposes MB better under these conditions, which was also confirmed by quantum chemical calculations in our previous works.

Thus, the control of the process of oriented attachment makes it possible to regulate not only the morphological, but also the photocatalytic properties of ZnO nanoparticles.

### Acknowledgements

This work was supported by the Russian Science Foundation (project No 23-23-00220). The research was carried out on the basis of the St. Petersburg State University Research Park, including the resource centers “RDMI”, “MASV”, “OLMIV”, “VC”, “Cryogenic Department”, “MRCNT”.

# PREPARATION AND STUDY OF PHYSICO-CHEMICAL PROPERTIES OF PARAFFIN NANO-SIZED AQUEOUS DISPERSIONS. DEVELOPMENT OF PHASE CHANGE MATERIALS BASED ON PARAFFINS

*Mrachkovskaya D.A.<sup>1</sup>, Gudkova E.G.<sup>1</sup>, Kuryakov V.N.<sup>2</sup>*

<sup>1</sup> Dmitry Mendeleev University of Chemical Technology of Russia, Moscow, Russia

<sup>2</sup> Oil and Gas Research Institute of the Russian Academy of Sciences, Moscow, Russia  
Student

[danamrachkovskaya@yandex.ru](mailto:danamrachkovskaya@yandex.ru)

Phase change materials (PCM) are attracting increasing attention from researchers and engineers due to their potential to utilize the latent heat of phase transitions for various applications such as thermal energy storage, heat exchange processes, and thermal barriers. Interest in PCM continues to grow due to the need to develop efficient and environmentally friendly technologies as well as to improve the energy efficiency of various systems.

Of particular interest is the study of the phase behavior of n-alkanes as potential components of PCM. n-Alkanes are simple organic compounds consisting of linear chains of carbon atoms that possess a number of unique physical and chemical properties. It is important to note that n-alkanes have specific phase behavior. Firstly, they exhibit rotator phases - quasicrystalline structures and transitions between them are possible, i.e. phase transitions of the solid-solid type. Secondly, they are characterized by the effect of surface crystallization – when a molten n-alkane is cooled, a crystalline monolayer appears on the surface of the liquid, at temperatures 2-3 degrees above the melting point [1, 2].

n-Alkanes have several advantages that make them promising candidates for use in PCM. They have a wide range of phase transition temperatures depending on the number of carbon atoms in the molecule, high heat capacity, are non-toxic, chemically inert, and are available in production [3]. Thus, studies of the phase behavior of n-alkanes are important both from the fundamental point of view for understanding the peculiarities of phase transitions in organic compounds and from the practical point of view for the development of new and improvement of existing PCM based on them.

This work is devoted to the preparation and investigation of physicochemical properties of nanosized aqueous dispersion of n-eicosane (C<sub>20</sub>H<sub>42</sub>) with a characteristic particle size (radius) of 100 nm (measured by DLS) and describes a method for obtaining such a stable dispersion without the use of surfactants. It is important to note that the studied dispersions can withstand multiple heating-cooling cycles while maintaining colloidal stability, which is an important property for PCM.

Using the ultramicroscopy method NP Counter (NP Vision, Russia) [4], the numerical concentration of n-alkane nanoparticles was measured for the studied samples. An estimate was made of the mass concentration of n-alkane in samples from such measurements, taking into account data on the average particle size by the DLS method.

By means of new optical method, the temperatures of phase transitions during heating and cooling of the studied sample of a nano-sized aqueous dispersion of n-alkane were determined. This method is based on measuring the temperature dependence of the intensity of scattered light on the dispersion under study. During the phase transition of n-alkane particles in the dispersion, their refractive index will change abruptly, which will lead to a change in the intensity of the scattered light. In this way, optical changes in the system are measured, rather than thermal effects, as in calorimetry. The measured temperatures of phase transitions (melting, crystallization, rotator phases) in samples of aqueous n-alkane dispersions coincide with published data.

## References

- [1] *J. Chem. Phys.* **1994**, 101, 10873
- [2] *J. Chem. Phys.* **1993**, 98, 5809
- [3] *Int. J. Heat Mass Transfer* **2020**, 161, 120285
- [4] [website] URL: <http://npcounter.ru/> (Cited May 11, 2024)

## Acknowledgements

This work was supported by the Russian Science Foundation (project No 24-29-00563).

# USING DIELECTRIC MIE-RESONANCES IN SEMICONDUCTOR NANOHETEROSTRUCTURES FOR PHOTOCATALYSIS ENHANCING

*Murausky D.I.<sup>1</sup>, Artem'ev M.V.<sup>1</sup>*

<sup>1</sup> Research Institute for Physical Chemical Problems of the Belarusian State University, Minsk, Belarus

PhD student

[dmitry\\_murausky@mail.ru](mailto:dmitry_murausky@mail.ru)

Core-shell nanoheterostructures based on amorphous selenium nanospheres of 200 nm with Ag<sub>2</sub>Se shell of 2 nm exhibit pronounced dielectric Mie-resonances with high extinction cross-section, and low optical losses in the visible region [1]. Semiconductor nature, high monodispersity and amorphous structure in combination with strong Mie-resonances in the visible region make a-Se/Ag<sub>2</sub>Se nanoparticles (NPs) a promising material with enhanced photocatalytic activity. Here, we demonstrate the influence of dielectric Mie-resonances in colloidal a-Se/Ag<sub>2</sub>Se NPs of 200 nm on the rate of leuco-methylene blue (LMB) photooxidation.

We propose that Mie-resonance optical excitation in the spectral region of Ag<sub>2</sub>Se absorption provides enhanced e-h pairs photogeneration in Ag<sub>2</sub>Se shell due to Mie-scattering resonance energy transfer (MIRET) [2]. According to the energy diagram (Fig. 1a) photogenerated holes are able to oxidize LMB molecules near the surface of NPs, while photogenerated electrons are captured at trapping levels of a-Se core.

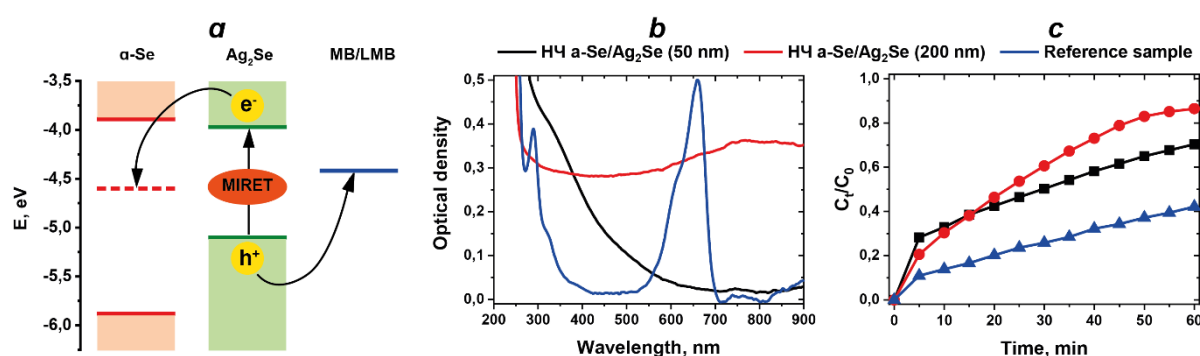

**Figure 1.** Proposed mechanism of leuco-methylene blue photooxidation in the presence of a-Se/Ag<sub>2</sub>Se NPs of 200 nm (a); extinction spectra of colloidal NPs and methylene blue solution before reduction, used in the kinetic experiments (b); kinetics of leuco-methylene blue photooxidation (c).

To identify the influence of dielectric Mie resonances on the rate of LMB photooxidation we used reference sample without NPs and samples of a-Se/Ag<sub>2</sub>Se NPs of 50 nm (without Mie-resonances) and 200 nm (with Mie-resonances at  $\lambda \geq 600$  nm) (Fig 1b). Aqueous colloidal solutions of NPs (1.3 mL, pH=5), purified by dialysis, were studied under Ar in the presence of 0.5 wt% polyacrylamide ( $M_w=1000000$ ) and 6.8  $\mu$ M LMB, pre-obtained by MB reduction on Zn-amalgam. The total surface area of NPs in the solutions was constant in all experiments. Kinetic experiments were carried out with constant stirring in the dark or under LED illumination at  $\lambda \geq 620$  nm, favoring e-h pairs photogeneration in Ag<sub>2</sub>Se shell and Mie-resonance excitation. The extinction spectra of the solutions under study were measured every 5 min to determine the optical density at the maximum of MB absorption band (662 nm). The data obtained was used to plot kinetic curves (Fig. 1c). The rate of LMB photooxidation in the presence of 200 nm a-Se/Ag<sub>2</sub>Se NPs is 2 times higher compared to 50 nm NPs, taking into account LMB photooxidation kinetics in the absence of NPs (reference sample). This fact clearly indicates photocatalysis enhancement provided by MIRET effect. Thus, a-Se/Ag<sub>2</sub>Se NPs of 200 nm can be considered as perspective semiconductor photocatalyst with high effectivity in the visible and near-infrared region.

## References

- [1] *Appl. Surf. Sci.* **2020**, 513, 1
- [2] *ACS Catalysis* **2022**, 12, 7975

## Acknowledgements

This work was supported by the program 2.1.04.01 «Chemical processes, reagents and technology, bioregulators and bioorganic chemistry».

# CRYSTALLIZATION CONTROL OF ANIONIC THIALCALIXARENES ON SILICON SURFACE COATED WITH CATIONIC POLY(ETHYLENEIMINE)

*Muravev A.A., Botnar A.A., Skorb E.V.*

ITMO University, St. Petersburg, Russia

PhD

[muravev@itmo.ru](mailto:muravev@itmo.ru)

Surface modification of solid substrate with macrocycles and polyelectrolytes is a promising strategy towards advanced soft materials due to the control of molecular arrangement and supramolecular organization [1-2]; however, understanding the nature of interactions within the assembly is challenging.

Here a facile approach to the control of the architecture of calixarene macrocycles on soft surfaces is presented through the interplay of weak interactions involving solid silicon substrate, cationic polyelectrolyte layer, and anionic sulfonatothiacalix[4]arene (STCA) (Scheme 1). Topological analysis of atomic force microscopy (AFM) images of STCA on silicon, as well as silicon wafers modified with neutral polyethyleneimine (PEI) and cationic PEI-H<sup>+</sup> indicates different surface morphology and assembly behavior of STCA on such substrates. Drop-casting of calixarene solution onto silicon induces the formation of chaotically oriented needle crystals. When there is globular PEI, a nucleation point for the STCA crystals is formed on the polyelectrolyte surface, which grow into rosette structures. In contrast, protonated PEI with a chain-like structure alters the self-organization of STCA on silicon surfaces leading to a dense uniform fiber-like network. These results are promising for the development of ion-permeable biocompatible membranes suitable for tissue regeneration and other self-healing materials utilizing guest encapsulation behavior of thiacalixarene cavity and adaptive and responsive properties of flexible polyelectrolyte nanofilm. Density functional theory modeling of the system components self-assembly reveals thermodynamically favorable face-to-face antiparallel aggregation of STCA monomers and contribution of H-bonding into PEI(PEI-H<sup>+</sup>)-STCA and Si-STCA association.

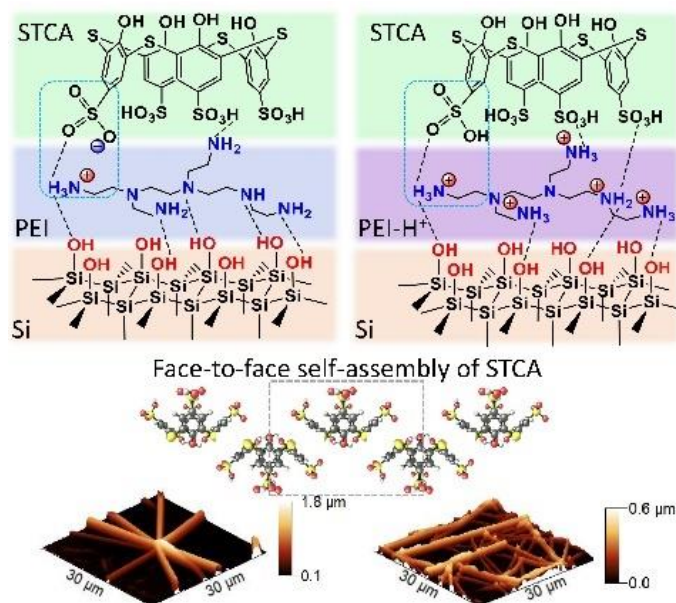

**Scheme 1.** AFM visualization and DFT calculation of self-assembly of sulfonatothiacalix[4]arene molecules on the PEI-coated silicon wafer

## References

- [1] *Adv. Mater.* **2024**, 36, 2310429
- [2] *Int. J. Mol. Sci.* **2022**, 23, 2341

## Acknowledgements

The authors thank the Priority-2030 program for infrastructural support.

# MESOPOROSITY DEVELOPMENT IN ZEOLITES AND STUDY OF GLYCEROL SORPTION AND CATALYTIC PROPERTIES OF MICROPOROUS AND MESOPOROUS ZEOLITES MODIFIED WITH TRANSITIONAL METALS

*Neupokoev A.I.<sup>1</sup>, Minich I.A.<sup>1</sup>, Kruchkova T.A.<sup>2</sup>, Sheshko T.F.<sup>2</sup>, Zvereva I.A.<sup>1</sup>*

<sup>1</sup> St. Petersburg State University, St. Petersburg, Russia

<sup>2</sup> Peoples' Friendship University of Russia, Moscow, Russia

Student

[st107398@student.spbu.ru](mailto:st107398@student.spbu.ru)

Biomass is a rich source of renewable carbon, which can be converted using a range of technologies into environmentally friendly fuels and chemicals. An important environmental problem is the large number of waste products from the production of biodiesel, in particular crude glycerol, the main by-product (about 10 wt.%) of the biodiesel industry. Utilization of glycerol with conversion to products with high added value is currently an urgent task in the direction of green, energy-saving and low-carbon development in the field of atmospheric ecology and the development of bioenergy. In this regard, effective methods of increasing conversion (dehydration, carboxylation and other processes) are highly required [1,2]. The effectiveness of glycerol conversion is determined by a catalyst and its sorption capacity in respect to glycerol. Moreover, the development of mesoporous structures is important for the kinetics of the sorption and chemical reactions.

In this contribution we report results of the synthesis of mesoporous zeolites starting from microporous ones, results of the investigation of glycerol sorption for pristine microporous and mesoporous samples and results of testing efficiency of zeolites under investigation in reactions of dehydration and carboxylation of glycerol. The objects under investigation are series of catalysts with different type of structure – mordenite and ZSM-5, and different content in ratio of Al/Si.

The procedure for the development of mesoporosity was carried out by treating microporous zeolites with a solution of sodium hydroxide under low heating in order to create disordered secondary porosity. Moreover, the protonated form was obtained by treating dried leached samples with ammonium nitrate, followed by calcination. Nanoparticles of Ag and other transition metals were precipitated from solutions of salts, for example, silver nitrate. The change in Al/Si ratio was followed by EDX analysis (Shimadzu EDX 800 HS). Surface area, pore volume and pore size have been estimated by BET and BJH methods on the base of nitrogen adsorption experiments (QuadraSorb SI).

The sorption of glycerol have been investigated by methods of thermogravimetry of desorption (Netzsch STA 449 F1) and by isothermal calorimetry of sorption (Setaram C80) for various microporous and mesoporous zeolites. A comparative analysis will be focused on the role of zeolite topology and secondary porosity as it was done in [2]. Finally, the amount of glycerol and heat effect of sorption have been obtained as specific values in respect to zeolite-base catalysts and glycerol molecules. As additional result of thermal analysis the preferable temperature for reactions of the glycerol conversion has been estimated.

It will be present some results of catalytic efficiency of modified zeolites under investigation in reactions of glycerol conversion in value-added chemicals - dehydration to acetol in gaseous reactions and carboxylation to glycerol carbonate in liquid medium.

The research was conducted using the equipment of the Saint Petersburg State University Research Park: Center for Thermal Analysis and Calorimetry, Interdisciplinary Center for Nanotechnology, Center for Diagnostics of Functional Materials for Medicine, Pharmacology and Nanoelectronics.

## References

[1] Catalysts **2022**, 12, 897.

[2] Current Research in Green and Sustainable Chemistry **2021**, 4, 100199

[3] J Therm. Anal. Calorim. **2022**, 147, 6147.

## Acknowledgements

This research was funded by the Russian Federation represented by the Ministry of Science and Higher Education of Russia, Agreement No 075-15-2023-611 dated August 30, 2023.



# STUDY OF THE EXFOLIATION OF LAYERED DOUBLE HYDROXIDES IN AQUEOUS MEDIA AND THEIR PHOTOCATALYTIC ACTIVITY

*Novikov S.S.<sup>1</sup>, Silyukov O.I.<sup>1</sup>*

<sup>1</sup> St. Petersburg State University, St. Petersburg,  
Russia  
Student  
[st094940@student.spbu.ru](mailto:st094940@student.spbu.ru)

The problem of finding environmentally friendly sources of energy is acute today. One of the many ways to solve this problem is to develop methods, including the use of photochemical processes, in which part of the solar radiation can initiate chemical reactions, one of the most attractive being the reaction of water decomposition to produce hydrogen. With this in mind, an important task is to obtain the most active photocatalyst, i.e. a substance that facilitates the course of photoreactions.

Among the others, the use of layered double hydroxides (LDHs) (compounds whose structure can be described as an alternation of positively charged layers consisting of double metal hydroxides and an interlayer space where anions are located) is attractive. Because of this layered structure, these substances have a significant potential for further modification, in particular the introduction of different molecules into the interlayer space [1], the formation of composite materials based on them, or the splitting (exfoliation process) into separate layers [2]. Subsequent changes in the structure make it possible to significantly increase the photocatalytic activity of the layered double hydroxide itself or a composite material based on it.

The present research focuses on a new method of exfoliation of layered double hydroxides Ni/Al, Mg/Al and Co/Al and on the study of the photocatalytic activity in the hydrogen evolution reaction of their exfoliated form. Within the framework of this method, carbonate forms of these layered double hydroxides were synthesized by hydrothermal method, which consisted of mixing nitrates of the corresponding metals (in a ratio of 2/1 divalent and trivalent) with methenamine (concentration in solution = 0.15 M) in an autoclave, the hydrolysis of which at 150°C for one day led to the formation of the target carbonate form of LDH, which was separated by centrifugation and after have been washed to a neutral environment. Subsequently, a method for obtaining nitrate forms of these LDHs was studied, since at different concentrations of reagents and acidity of the medium, samples with different degrees of purity were obtained, in particular, it was found that the most single-phase samples are obtained when 200 mg of the carbonate form of LDH is placed in 20 ml of an acidic solution of sodium nitrate (104 µl of nitric acid and 2.55 g of sodium nitrate). The method itself consisted of mixing in a specific proportion LDH, sodium nitrate and a solution of nitric acid, after which the solution was stirred for two days with the replacement of the solution. In this work, the exfoliation of LDH in aqueous solutions of organic substances (DMSO, DMF, formamide, THF, isopropanol, N-methyl-2-pyrrolidone) was studied, carried out by forming a suspension under the influence of ultrasound for one hour at temperature control (10°C) in a dispersing agent, after which the solution was centrifuged for an hour at RCF = 1000. The resulting nanolayers were separated from unexfoliated part by centrifugation and were studied by dynamic light scattering, UV-Vi's spectroscopy and scanning electron microscopy. The photocatalytic activity was studied for the reaction of hydrogen evolution from methanol solution, which consists in illuminating a given solution in the reactor with an ultraviolet lamp, where the target reaction took place during thermostating, the gas products of which were recorded by gas chromatography.

It has been found that the smallest hydrodynamic radii (46-60 nm) have LDH whose decomposition has been carried out in DMSO, DMF, N-methyl-2-pyrrolidone and especially in isopropanol, indicating their successful decomposition in these aqueous media, and has also been studied the photocatalytic activity of exfoliated forms in the reaction of hydrogen evolution from an aqueous solution of methanol.

## References

- [1] Gholami P. et al. *Hazard Mater.* **2020**, 81, 352-359  
[2] Qiu L., Chen W., Qu B. *Polym Degrad Stab.* **2005**, 87, 433-440

**Acknowledgements.** The study was supported by the Russian Science Foundation (grant № 22-73-10110). The authors are grateful to the Saint Petersburg State University Research Park: Centre for X-ray Diffraction Studies, Centre for Optical and Laser Materials Research, Centre for Chemical Analysis and Materials Research, Centre for Thermal Analysis and Calorimetry, Interdisciplinary Centre for Nanotechnology, Center for Diagnostics of Functional Materials for Medicine, Pharmacology and Nanoelectronics

## ENCAPSULATION OF HYDROPHOBIC ANTICANCER DRUGS USING GOLD NANORODS (GNRS) FOR SIMULTANEOUS CHEMOTHERAPY AND PHOTOTHERMAL THERAPY(CHT-PTT)

*Shukla N.<sup>1</sup>, Das R.<sup>2</sup>, Mukhanova E.<sup>1</sup>, Soldatov A.<sup>1</sup>*

<sup>1</sup>Southern Federal University, 344090 Rostov-On-Don, Russia

<sup>2</sup>Dr Hari Singh Gour University Sagar MP India

post doc

[nutanshukla14@gmail.com](mailto:nutanshukla14@gmail.com)

One of the main obstacles in the delivery of chemotherapy is now the development of drug delivery systems (DDSs) with therapeutic selectivity and efficacy. Furthermore, the hydrophobicity of chemotherapeutic medicines hinders the efficacy of DDSs that are now under investigation. When multiple cancer treatment modalities, including photothermal therapy (PTT) and chemotherapy (CHT), are combined, the synergistic improvement of anticancer drug localization and therapeutic efficacy is accomplished. These multimodal approaches provide localized heat-assisted death and anticancer medicine administration at the same time as reducing the inadvertent systemic side effects of a single therapy. However, when CHT-PTT is utilized as a direct cancer treatment, its effectiveness is diminished due to its non-targeted effects. Considering the previously described limitations of CHT-PTT, we developed a GNRS-based nanoplatform that improved drug/dye accumulation by means of FR-targeted endocytosis. To sum up, GNRS were electrostatically coupled to amphiphilic PPEG-Folic acid (PPFA) that had already been produced. GNRS functionalized with water-soluble amphiphilic ligands form kinetically stable complexes when paired with hydrophobic drugs and dyes. The effective release of these medications and dyes into cells has been shown by cytotoxicity tests and fluorescence microscopy. Notably, the particles exhibit negligible or no cellular absorption, rendering these low-toxicity particles highly attractive for use in delivery applications. The loading of three distinct hydrophobic anticancer drugs was greatly improved by the synthesized PPFAGNRs. Conversely, FA on the PPFAGNR moiety promotes the development of nanoplatform toward overexpressed FR. When exposed to near-infrared (NIR) radiation, the plasmonic characteristic of the GNR raises temperature. This causes all anticancer medications to release more readily and progressively reduces the viability of cancer cells. Our findings demonstrate that GNR-based nanoplatform may efficiently transport hydrophobic drugs to their target site and function remarkably well in conjunction.

### References

- [1] V. Wagner, A. Dullaart, A. K. Bock and A. Zweck, *Nat. Biotechnol.*, 2006, 24, 1211–1217.
- [2] T. M. Allen and P. R. Cullis, *Science*, 2004, 303, 1818–1822.
- [3] P. Botella, I. Abasolo, Y. Fern´andez, C. Muniesa, S. Miranda, M. Quesada, J. Ruiz, S. Schwartz Jr and A. Corma, *J. Controlled Release*, 2011, 156, 246–257.
- [4] D. Peer, J. M. Karp, S. Hong, O. C. Farokhzad, R. Margalit and R. Langer, *Nat. Nanotechnol.*, 2007, 2, 751–760.
- [5] C. K. Kim, P. Ghosh, C. Pagliuca, Z. J. Zhu, S. Menichetti and V. M. Rotello, *J. Am. Chem. Soc.*, 2009, 131, 1360–1361.
- [6] K. Dong, Z. Liu, Z. Li, J. Ren and X. Qu, *Adv. Mater.*, 2013, 25, 4452–4458.
- [7] E. Miele, G. P. Spinelli, E. Miele, F. Tomao and S. Tomao, *Int. J. Nanomed.*, 2009, 4, 99–105.
- [8] N. Ahmed, C. E. Mora-Huertas, C. Jaafar-Maalej, H. Fessi and A. Elaissari, in *Drug Delivery Strategies for Poorly Water Soluble Drugs*, ed. D. Douroumis and A. Fahr, John Wiley & Sons Ltd, Oxford, UK, 2013, ch. 5, pp. 151–197.
- [9] N. Reum, C. Fink-Straube, T. Klein, R. W. Hartmann, C. M. Lehr and M. Schneider, *Langmuir*, 2010, 26, 16901–16908.
- [10] J. C. Y. Kah, J. Chen, A. Zubieta and K. H. Schifferli, *ACS Nano*, 2012, 6, 6730–6740.
- [11] X. Q. Zhang, X. Xu, R. Lam, D. Giljohann, D. Ho and C. A. Mirkin, *ACS Nano*, 2011, 9, 6962–6970.
- [12] M. Colombo, S. Mazzucchelli, V. Collico, S. Avvakumova, L. Pandol, F. Corsi, F. Porta and D. Prospero, *Angew. Chem., Int. Ed.*, 2012, 51, 9272–9275.
- [13] E. R. Hernandez, A. Baeza and M. V. Regi, *ACS Nano*, 2011, 5, 1259–1266.

### Acknowledgements

The research was supported by the Strategic Academic Leadership Program of the Southern Federal University ("Priority 2030")

# THERMAL AND FROST-RESISTANT POLYDIMETHYL(METHYLBENZYL)SILOXANES: SYNTHESIS AND PROPERTIES.

*Olenich E.A.*<sup>1</sup>, *Gorodov V.V.*<sup>1</sup>, *Milenin S.A.*<sup>1,2</sup>, *Cherkaev G.V.*<sup>1</sup>, *Khanin D.A.*<sup>3</sup>, *Buzin M.I.*<sup>3</sup>, *Muzafarov A.M.*<sup>3</sup>

<sup>1</sup> Enikolopov Institute of Synthetic Polymeric Materials Russian Academy of Sciences (ISPM RAS)

<sup>2</sup> Federal State Budgetary Educational Institution of Higher Education "Tula State Pedagogical University named after. L.N. Tolstoy"

<sup>3</sup> A. N. Nesmeyanov Institute of Organoelement compounds Russian Academy of Sciences Moscow  
PhD student, 1 year

[Ekaterina.olenich@ispm.ru](mailto:Ekaterina olenich@ispm.ru)

Polyorganosiloxanes are a large and important group of diverse hybrid compounds and materials known as "silicones". They play a key role among other polymers due to their unique properties. One of the most important features of these materials is their minimal change in mechanical and dielectric characteristics under moderate temperature increase. It is known that PDMS has a very low glass transition temperature (-123°C), this fact is making these polymers highly promising for creating frost-resistant materials. However, its crystallization temperature is relatively high (-40°C), significantly limiting the application of such polymers in low-temperature conditions without additional structure modification [1,2]. Phenyl, ethyl, and other groups can act as modifying fragments, which can suppress crystallization. Previously, it was shown that the introduction of 3 mol% benzyl fragments into the macromolecule chain suppresses the crystallization of PDMS. However, the synthesis process was poorly controlled [3].

One of the main methods for obtaining polyorganosiloxanes of various structures is ring-opening polymerization (ROP). It enables the production of high molecular weight polymers with relatively well-defined molecular weight compared to polycondensation methods [4]. The main substrates, which are using in such reactions are organocyclosiloxanes. The most important substances of this class are octamethylcyclotetrasiloxane (D4) and hexamethylcyclotrisiloxane (D3). Cyclosiloxanes, which contain fragment other than methyl, such as ethyl, fluoroalkyl, phenyl, etc., are used to obtain copolymers with desired performance properties (oil resistance, heat resistance, improved cold resistance). Organocyclosiloxanes of mixed composition are of particular interest because with such monomers, the necessary material properties can be incorporated at the molecular level [5].

In this regard, we decided to modernize the synthesis of methylbenzyl copolymers. For this purpose, we synthesized 1-benzyl-1,3,3,5,5,7,7-heptomethylcyclotetrasiloxane. The kinetics of its copolymerization were studied, and a series of copolymers based on it were obtained and their thermophysical properties were investigated (**Figure 1**).

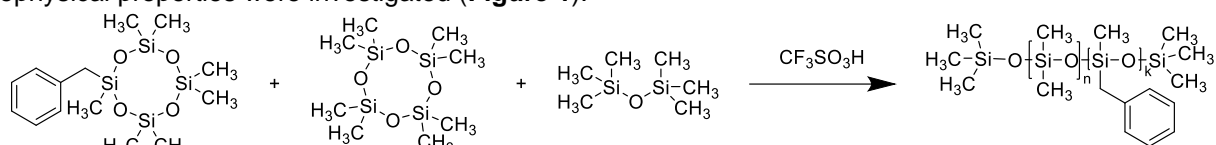

**Figure 1.** Scheme for obtaining polymer based on 1-benzyl-1,3,3,5,5,7,7-heptomethylcyclotetrasiloxane

## References

- [1] *Polymer* **1985**, 26, №. 6, 930-934
- [2] *Macromolecules* **2020**, № 15(53), 6452–6460.
- [3] *Polymer Science, Series B*, **2023**, 65(6), 812-820.
- [4] *Polymers*, **2022**, 14(12), 2408
- [5] *Journal of applied polymer science*, **2001**, 82(13), 3333-3340.

## Acknowledgements

This work was supported by the Russian Science Foundation (project № 21-73-30030)

# PREPARATION AND ELECTROMAGNETIC WAVE ABSORPTION PROPERTIES OF Ni/C COMPOSITE AEROGELS

Pan Wang<sup>1</sup>, Xijiang Han<sup>1</sup>, Yunchen Du<sup>1</sup>

<sup>1</sup>Harbin Institute of Technology, Harbin, China

Graduate student

[wangpan2029@163.com](mailto:wangpan2029@163.com)

Magnetic carbon-based aerogel is an emerging high-performance electromagnetic wave absorbing material due to its unique structural advantages, which lays a good foundation for electromagnetic wave propagation and attenuation [1-2]. However, the traditional post-processing methods of magnetic carbon-based aerogels have difficulties in maintaining the aerogel structure, adjusting the content of magnetic components, and dispersing the magnetic particles [3-5]. In this research, we first induce a topological deformation of bulky Ni-MOF particles to generate Ni-MOF aerogel assembled by crosslinked fibers, and then convert this intermediate aerogel into final Ni/C composite aerogels (NCCAs) through controllable high-temperature pyrolysis. This novel strategy achieves high loading and homogeneous dispersion of magnetic metal nanoparticles on the carbon skeleton. The best product (NCCA-2) exhibits the best electromagnetic absorption performance in this series of composites with strong reflection loss and wide effective absorption bandwidth. Subsequently, we employ Ni-MOF as a precursor, induce topological deformation in the presence of graphene oxide (GO) nanosheets, and finally harvest the composite aerogels composed of GO nanosheets and Ni-MOF fibers. It is found that GO nanosheets can resist the thermal shrinkage of composite aerogels during high-temperature pyrolysis and endow the final Ni/C@rGO composite aerogels (NCGCAs) with extremely high porosity (96.4%) and low density (0.04 g cm<sup>-3</sup>). Electromagnetic analyses reveal that both the changes in structure and composition reinforce the overall loss capability of NCGCAs effectively, and thus generate obvious improvements in broadband response with a thin thickness (12.8-18.0 GHz, 1.5 mm). The good EM absorption performance of NCGCAs is significantly superior to those of many reported Ni/C aerogels. In addition, the structural advantage of NCGCAs also demonstrates their potential application in thermal management. This GO-mediated MOFs deformation is a promising strategy for the formation of high-porosity magnetic metal/carbon composite aerogels, which may bring some unexpected benefits in different fields.

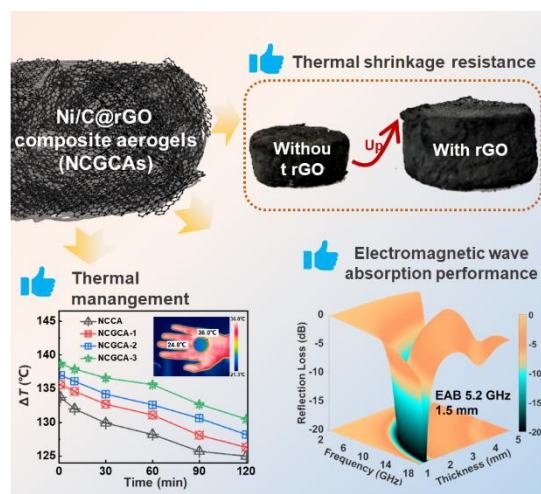

Scheme 1. ToC figure this research.

## References

- [1] *Adv. Mater.* **2004**, *16*, 401-405
- [2] *J. Mater. Chem. A.* **2015**, *3*, 13426
- [3] *ACS Appl. Mater. Interfaces.* **2015**, *7*, 13604-13611
- [4] *Nano-Micro Lett.* **2019**, *17*, 76
- [5] *Adv. Funct. Mater.* **2019**, *29*, 1807624

## Acknowledgements

This work was supported by National Natural Science Foundation of China (21776053 and 52373262).

## PRODUCTION OF WC-ZrO<sub>2</sub> CERAMICS FROM NANOCRYSTALLINE MIXTURES

*Pankratova E.M.<sup>1,2</sup>, Kurlov A.S.<sup>1</sup>*

<sup>1</sup> Institute of Solid State Chemistry of the Ural Branch of the Russian Academy of Sciences,  
Yekaterinburg, Russia

<sup>2</sup> Ural Federal University, Institute of Physics and Technology,  
Yekaterinburg, Russia

Student

[pankratova@ihim.uran.ru](mailto:pankratova@ihim.uran.ru)

Tungsten carbide WC, due to a unique combination of high hardness and strength that persist even at relatively high temperatures, is the main component of the most widespread hard alloys used in metal working, mining and oil and gas industries. One of the ways of improving the performance of these materials is to go from micro- to submicro- and nanostructure [1]. However, as the particle size is reduced, the surface area increases and is easily contaminated by atmospheric oxygen. During sintering, impurity oxygen partially decarburizes WC, being removed in the form of CO and CO<sub>2</sub>, which leads to a change in the phase composition and formation of a porous structure of the final material [2, 3].

In this work, an attempt was made to prevent the decarburization of nanocrystalline WC during sintering by binding the impurity oxygen into a strong, hard and refractory oxide ZrO<sub>2</sub> before it interacts with carbide carbon.

For these purposes, ZrC was added to WC; its amount was calculated by the change in the phase composition (carbon loss) during sintering of nanocrystalline WC without additives. Nanocrystalline powders ( $D_{\text{aver}} \approx 20\text{-}30$  nm) of WC, WC-ZrC and WC-ZrC-Y<sub>2</sub>O<sub>3</sub> were prepared from microcrystalline powders ( $D_{\text{aver}} \approx 4\text{-}5$  μm) of WC, ZrC and Y<sub>2</sub>O<sub>3</sub> in a planetary ball mill Retsch PM 200 using 3 mm milling balls and 50 ml jars made of WC-Co hard alloy. The following milling parameters were used: 10 hours with 500 rpm rate; powder to balls ratio 1:10; volume of C<sub>3</sub>H<sub>8</sub>O – 10 ml. Compaction of the obtained powder mixtures was carried out at room temperature in a steel cylindrical mold with a diameter of 7.45 mm by uniaxial pressing under a pressure of ~ 460 MPa. The green compacts were sintered in a high-temperature laboratory vacuum furnace Centorr LF-22-2000 with 15 min exposure at 1400 °C and vacuum ~ 10<sup>-2</sup> Pa. After sintering, the samples were cut across the cross section. Then the internal surface was ground and polished on a BUEHLER MOTOPOLO 8 facility using special grinding disks and diamond suspensions with particle size from 30 to 1 μm.

The initial microcrystalline powders, nanocrystalline powder mixtures prepared therefrom, as well as their compressed and sintered samples were certified using X-ray diffraction, BET method, chemical analysis for carbon and oxygen content, scanning electron microscopy with EDS analysis, pycnometry and Vickers method. Simultaneous thermo-gravimetric analysis and differential scanning calorimetry (TGA-DSC) were used to study the chemical and physicochemical processes occurring in nanocrystalline powders during heating.

The studies performed showed that the use of nanocrystalline powders makes it possible to obtain dense (up to 99%) and hard (11-26 GPa) ceramics by conventional vacuum sintering. The ZrC additive prevents the decarburization of WC during sintering of ceramics by binding impurity oxygen into monoclinic m-ZrO<sub>2</sub> oxide, and when Y<sub>2</sub>O<sub>3</sub> is added to the mixture, oxygen is bound into tetragonal t-ZrO<sub>2</sub> (YSZ). It was shown that the presence of oxide inclusions ZrO<sub>2</sub> does not preclude intensive growth of WC grains during sintering, rather the opposite, it contributes to it. In addition, the presence of ZrO<sub>2</sub> in WC-based ceramics leads to a reduction in microhardness, but increases its crack resistance, especially in the case of the tetragonal phase t-ZrO<sub>2</sub> (YSZ).

### References

- [1] *Int. J. Refract. Met. Hard Mater.* **2019**, 80, 40
- [2] *Int. J. Refract. Met. Hard Mater.* **2011**, 29, 221
- [3] *AIP Conf. Proc.* **2022**, 2466, 060002

# COMPOSITE SINGLE CRYSTAL LAYERED OXIDES AS POSITIVE ELECTRODES FOR ADVANCED LI-ION BATTERIES

*Pavlova A.D.<sup>1</sup>, Savina A.A.<sup>1</sup>, Abakumov A.M.<sup>1</sup>*

<sup>1</sup> Skolkovo Institute of Science and Technology, Moscow, Russia

Poster, PhD-1 Student

[Alina.Pavlova@skoltech.ru](mailto:Alina.Pavlova@skoltech.ru)

Lithium-ion batteries (LIBs) demonstrate many advantages, such as high energy density, low self-discharge, long cycle life, and negligible memory effect, making them competitive in battery market [1]. LIBs have been used in mobile devices, electric vehicles, hybrid electric vehicles, stationary energy storage, and other fields. The electrochemical performance of LIBs depends on the positive electrode (cathode), therefore, the development of cathode materials with higher energy density, longer cycle life, and higher safety is one of the most important scientific and industrial issues [2]. Currently used positive electrode materials such as LiCoO<sub>2</sub> (LCO), LiFePO<sub>4</sub> (LFP), LiMn<sub>2</sub>O<sub>4</sub> (LMO), LiNi<sub>x</sub>Co<sub>y</sub>Mn<sub>z</sub>O<sub>2</sub> ( $x+y+z=1$ ,  $x<0.6$ ) [3], do not have sufficient performance characteristics for a confident shifting of from internal combustion engines to electric vehicles. In turn, layered transition metal oxides LiNi<sub>x</sub>Co<sub>y</sub>Mn<sub>z</sub>O<sub>2</sub> with an increased nickel content ( $x \geq 0.6$ ), so-called Ni-rich NMCs, are the most promising materials for next-generation LIBs. Increased nickel content in LiNi<sub>x</sub>Co<sub>y</sub>Mn<sub>z</sub>O<sub>2</sub> provides both high specific capacity ( $\geq 220$  mAh/g) and high energy density ( $\geq 800$  Wh/kg) as well as lower cost compared with the commercialized LCO. However, although the high nickel content in the NMCs can increase specific capacity, their low electrochemical and mechanical stability hinders their further application in commercial LIBs. During Li (de)intercalation, the crystal structure of Ni-rich NMCs is known to undergo a series of phase transitions, causing sharp changes of the unit cell parameters. It leads to the accumulation of mechanical stresses and consequent microcracks propagation along the grain boundaries of the polycrystalline NMC. It entails the parasitic reactions of the material with the electrolyte components, causing capacity fade as well as compromising the battery safety [4].

The promising approach to mitigate these issues is the use of single crystal Ni-rich NMCs (SC-NMC) with the size of about 1–2  $\mu\text{m}$ . The SC-NMCs demonstrate reduced surface reactivity and transition metal dissolution towards electrolyte due to lower surface area and high structural wholeness. Moreover, the diminished porosity of the particles entails higher theoretical density as well as more mechanically stable through the calendaring process of the electrodes preparation. The significantly reduced number of intergranular boundaries in the bulk of the SC-NMC particles provides a reversible process of layer slip and self-healing of microcracks during prolonged cycling of the material, which affects a better resilience to the bulk changes during Li (de)intercalation. However, the problems of microcrack formation still exist since due to the near absence of grain boundaries, growth propagates along the movement of dislocations and irreversible planar gliding. Moreover, the kinetic characteristics of SC-NMC are worse than those of polycrystalline analogue, depending strongly on the state of charge (SOC) [5].

To solve both problems, within this work two new approaches based on synthesis of composite SC-NMC materials with nano-inclusions and core-shell structured SC-NMCs were applied. The first approach includes obtaining crystals reinforced with nanosized particles of non-isostructured compounds. In this case, the nano-inclusions act as a pinning center for microcracks, stopping their growth and improving the cyclic stability of the material during prolonged cycling at high current densities. The second method involves the synthesis of a core-shell structured SC-NMC, where Ni-rich SC-NMC acts as the core while Co-rich layered oxide is shell. The using Co-rich shell results in increasing the kinetics characteristics of the modified materials without losing the capacity retention.

## References

- [1] *IEEE Access*, **2017**, 5, 15372–15379
- [2] *Chem. Soc. Rev.*, **2020**, 49, 1569–1614
- [3] *J. Power Sources*, **2011**, 196, 2452–2460
- [4] *Chem. Mater.*, **2018**, 30, 1155–1163
- [5] *Ang. Chem. Int. Ed.*, **2021**, 60 (32), 17350-17355

## Acknowledgements

This work was supported by the Russian Science Foundation (project No 23-73-30003).

SELF-REINFORCEMENT EFFECT IN THE PROCESS OF SYNTHESIS OF GYPSUM COMPOSITES  
BASED ON FLY ASH WITH A HIGH CONTENT OF FREE CALCIUM OXIDE

*Petropavlovskii K.S.<sup>1</sup>, Novicenkova T.B.<sup>1</sup>, Kalyaskin P.A.<sup>1</sup>, Sulman M.G.<sup>1</sup>*

<sup>1</sup>Tver state technical university, Tver, Russia

PhD

[kspetropavlovsky@gmail.com](mailto:kspetropavlovsky@gmail.com)

The studies described in the work are devoted to the self-reinforcement of gypsum in the process of structure formation of the binder matrix. The development of the theory of hardening of gypsum composites provides a scientific basis for increasing performance characteristics and expanding the scope of their application. For example, in the field of 3D printing. The gypsum matrix, strengthened with crystals as a reinforcing element, is also the basis of structural materials. The use of fly ash with a high content of free calcium oxide increases the efficiency of the synthesis of composites.

# OPTIMIZATION OF DYE SENSITIZED SOLAR CELLS FOR EFFICIENT OPERATION UNDER LOW-LIGHT CONDITIONS AND ARTIFICIAL INDOOR ILLUMINATION

*Petrova V.I., Kozlov S.S., Alexeeva O.V., Nikolskaia A.B., Shevaleevskiy O.I.*

Emanuel Institute of Biochemical Physics, Russian Academy of Sciences, Moscow, Russia

Petrova V.I.

PhD student

[petrovavi@internet.ru](mailto:petrovavi@internet.ru)

During the last two decades novel emerging solar cell types based on brand new working principles have been extensively developed as an alternative to conventional crystalline silicon solar cells [1]. Among them, dye-sensitized solar cells (DSSCs) attract significant attention due to their potentially lower production costs, low toxicity and better performance under diffuse light conditions.

State-of-the-art DSSCs have power conversion efficiencies (PCE) exceeding 13% under standard lighting conditions (AM1.5G, 1000 W/m<sup>2</sup>). It was shown previously that DSSCs perform well under low-light intensities and under scattered lighting conditions, providing higher PCE values under light intensities in the 10 – 200 W/m<sup>2</sup> range as compared to standard AM1.5G illumination [2]. Moreover, under LED indoor light DSSCs showed impressive PCE values exceeding 25%, making this solar cell type suitable for various Internet-of-Things applications [3]. Considering the fact that lighting conditions close to AM1.5G are not often reachable, optimization of DSSCs particularly for low-light operation is of great fundamental and practical interest.

Conventional DSSCs based on TiO<sub>2</sub> mesoscopic nanocrystalline layers sensitized by ruthenium-based dyes (N719, C106) were used in this study. Optimized fast sensitization procedure using DMSO dye solutions was applied in order to decrease the TiO<sub>2</sub> staining time up to 10 minutes. Photoelectric properties of DSSCs were measured under varied light intensities in the range of 10 – 1000 W/m<sup>2</sup>. AM1.5 solar simulator was used as a light source and a set of neutral density filters (Marumi, Japan), uniformly decreasing the intensity of the light flux in the spectral range from 300 to 1100 nm, was used to reduce the incident light intensity. PCE measurements for DSSCs were also performed under LED artificial illumination at 1000 lux imitating indoor lighting conditions.

In this research particular attention was paid to the optimization of DSSCs performance under low-light conditions. The influence of several parameters, such as dye loading and the iodine concentration in the electrolyte on the photoelectrical characteristics DSSCs under low illumination conditions were studied. Obtained results showed that at reduced illumination intensities (10 – 100 W/m<sup>2</sup>) the PCE for studied DSSCs is increased by 20% as compared to the values obtained at standard lighting conditions. This effect is more pronounced for the DSSCs based on low I<sub>2</sub> electrolytes (I<sub>2</sub> concentration lower than 0.001 M). The physical processes which underlie the observed PCE enhancement in DSSCs under low illumination conditions were studied using EIS spectroscopy, open circuit voltage decay (OCVD) method and theoretical modelling. Observed effects were attributed to the decreased recombination at TiO<sub>2</sub>/electrolyte interface and increased charge collection efficiency.

Obtained results could be of great practical interest as they show that DSSCs could be effectively used as power sources for various wireless sensors (Internet of Things) and portable electronic devices both under low light outdoor conditions and indoor artificial light illumination.

## References

- [1] *Nat. Rev. Mat.* **2019**, 4, 269
- [2] *Nature Photonics* **2017**, 11, 372
- [3] *Sol. RRL* **2024**, 8, 2300574



## DESIGN OF THE PHOTOCATALYTIC PROPERTIES OF TIN DIOXIDE NANOPARTICLES THROUGH STRUCTURAL PARAMETERS AND SHAPE

*Podurets A.A.<sup>1</sup>, Skripkin E.V.<sup>1</sup>, Bobrysheva N.P.<sup>1</sup>, Osmolowsky M.G.<sup>1</sup>, Voznesenskiy M.A.<sup>1</sup>, Osmolovskaya O.M.<sup>1</sup>*

<sup>1</sup>St. Petersburg State University, St. Petersburg, Russia

PhD

[anastasiya.podurets@spbu.ru](mailto:anastasiya.podurets@spbu.ru)

With the fast urbanization and industrial growth water resources are threatened due to a large chemical discharge of the textile and pharmaceutical industries, healthcare facilities, or agriculture. This global trend has led to the development of waste-free purification methods, such as photocatalysis in the presence of semiconductor SnO<sub>2</sub> nanoparticles (NPs). It has previously been demonstrated that the photocatalytic activity of SnO<sub>2</sub> nanoparticles is determined by two factors: the potential efficiency of the photocatalyst (determines the number of radicals that produce particles per unit time) and the ability of its surface to form an activated complex with pollutant molecules, which simplifies the process of pollutant degradation. The first factor is determined by the ratio of oxygen vacancies and defects - essentially, the ratio of the number of charge carriers to the number of "traps" they can fall when migrating to the surface. The second factor depends on the nature of the pollutant and surface composition, particularly the ratio of different crystal facets, i.e., the particle shape.

In this study, obtained spherical nanoparticles with different ratios of oxygen vacancies and defects were obtained by varying synthesis conditions. Additionally, controllable shape transformation of samples towards rod-like nanoparticles were achieved by initiating oriented attachment (OA) processes using suspensions of the obtained spherical nanoparticles. OA mechanism based on the idea that two particles can combine into one if their crystallographic directions coincide, followed by the formation of a single crystal.

All as-prepared nanoparticles were characterized using a combination of physicochemical methods. As expected, XRD data demonstrated only rutile SnO<sub>2</sub> peaks (PDF 00-041-1445). According to TEM and SSA data, all samples demonstrate equal spherical shape and the average diameter below 4 nm. A combination of original techniques was used for the regulation and estimation of SnO<sub>2</sub> structural parameters. Defects and oxygen vacancies were determined using Raman spectroscopy and XPS, respectively, and their amount depends on the temperature and synthesis procedure. The evaluation of the oxygen vacancy concentration based on the combination of experimental approach and quantum chemical calculations, including solid-state UV-Vis absorption spectroscopy, modelling of band structure and density of states using DFT method.

Initial spherical blocks of 4 types with varying amount of oxygen vacancies and defects were obtained for post-synthetic treatment in hydrothermal conditions. The mechanism of oriented attachment (OA) process was investigated in details, and it can be concluded that the formation of rod-shaped particles of different sizes was determined by the favorable interaction of varying numbers of initial blocks along the 001 facet, which was confirmed by a decrease in parameter "c" for all samples after hydrothermal treatment. However, the different surface composition led to varying shielding capabilities of the components of the reaction medium.

Photocatalytic test of spherical and rod-shaped nanoparticles was conducted using three dyes of different nature, the structure of which gradually becomes more complex - Methylene Blue, Rhodamine 6G, and Congo Red. It was shown that spherical NPs exhibited higher photocatalytic activity for the dyes of simple structure, such as Methylene Blue and Rhodamine 6G, at the same time degradation of dyes of complex structure, such as Congo Red, rod-shaped NPs demonstrate higher photocatalytic activity. The optimal sample demonstrate over 90% degradation after 7 minutes under UV-irradiation. In this regard, a comprehensive study of photocatalytic properties was performed based on our developed protocol. Therefore, based on the results, it can be concluded that as-prepared samples after cycling test demonstrate stable high photocatalytic activity and reusable properties which makes it promising for efficient remediation.

### Acknowledgements

The work was financially supported by the Russian Science Foundation (project no. 23-23-00408, <https://rscf.ru/en/project/23-23-00408/>). Scientific research was performed at the research park of St. Petersburg State University: Centre for X-ray Diffraction Studies, Centre for Innovative Technologies of Composite Nanomaterials, Chemical Analysis and Materials Research Centre, Centre for Physical Methods of Surface Investigation, Computing Centre, Centre for Optical and Laser Materials Research, and Interdisciplinary Resource Centre for Nanotechnology.

## BIOINORGANIC SORBENT BASED ON IMPRINTED BOVINE SERUM ALBUMIN FOR EXTRACTION OF ECOTOXICANTS

*Presnyakov K.Yu., Kuprianova V.L., Lenivaya A.A., Pidenko P.S.*

Saratov State University, Institute of Chemistry Saratov, Russia

Postgraduate student

[kirillpresnyakov1999@ya.ru](mailto:kirillpresnyakov1999@ya.ru)

Many different types of food products are subject to contamination by natural pollutants (ecotoxins). The most common ecotoxins are produced by fungi. Fungi are capable of producing one to several ecotoxins, the most frequent producers are members of the genera *Aspergilli*, *Fusaria* and *Penicillia* [1]. A significant number of fungal secondary metabolites are mycotoxins, which mostly are harmful to mammals. The issue of mycotoxin contamination is particularly prevalent in grains and cereal crops, given the favorable storage conditions for fungal growth. The work focuses on zearalenone (ZEN), which is the mycotoxin with the high prevalence compared to other mycotoxins. The presence of ZEN in animal feeds and food products leads to various cellular changes, infertility in animals, and estrogenic disturbances in humans. This necessitates the development of efficient methods for concentration and inactivation of ZEN in natural matrices.

Numerous studies have been focused on design ZEN specific sorbents. At the same time, the transition from non-specific to selective sorbents is a modern trend in separation chemistry. Molecular imprinting technique is an approach for creating artificial recognition elements — molecularly imprinted polymers (MIP) [2]. Often, MIP syntheses are performed on a carrier surface to enhance sorbent properties. Practical interest is the generation of new binding sites at biopolymers (protein) structure. That approach called imprinting of proteins gives a possibility to obtain biosynthetic recognition elements — imprinted proteins (IPs). The uniqueness of using protein molecules is due to the conformational changes that occur during the formation of the protein-molecule-template complex [3]. Compared to organic polymer-based MIP, IPs have greater biocompatibility as well as the inherent advantages of proteins and enzymes. This makes it possible to use IPs to create highly selective analysis systems, catalysts, and sorbents compliant with the principles of “green” chemistry. Immobilization of IPs on bionatural carriers with highly developed surface has a number of advantages: an increase in the number of binding sites per unit mass of the carrier, increased stability and the possibility of creating a biologically neutral sorbent.

This study optimized the procedure for synthesizing IPs specific to ZEN using bovine serum albumin. It explored the influence of pH during template addition, the optimal method of IP purification was chosen, and the influence of the concentration of template on the sorption characteristics was studied. The bioorganic sorbent was obtained by immobilizing imprinted bovine serum albumin on the surface of commercially available silicon dioxide particles (Aerosil® 200). The sorption capacity of the bioorganic sorbent was found to be enhanced compared to native Aerosil® 200 particles ( $1.70 \pm 0.15$  and  $0.72 \pm 0.26 \text{ mg}\cdot\text{g}^{-1}$ , respectively). Furthermore, less than 5 % of ZEN was released from the sorbent, enabling the use of the created sorbent to combat mycotoxins directly in the digestive system of animals as a feed additive.

### References

- [1] *Crit. Rev. Food Sci. Nutr.* **1985**, 22(3), 177
- [2] *J. Sep. Sci.* **2013**, 36(3), 609
- [3] *J. Anal. Chem.* **2023**, 78.8, 953

### Acknowledgements

This work was supported by the Russian Science Foundation (project No 22–16–00102).

# ONE-STEP SYNTHESIS OF SILVER-CONTAINING NANOCOMPOSITES BASED ON FUNCTIONALIZED HYPERBRANCHED POLYESTERS USING SYNTHETIC GREEN CHEMISTRY APPROACHES

*Prytkov V.A.<sup>1</sup>, Osipova A.M.<sup>1</sup>, Hannanov A.A.<sup>1</sup>, Kuznetsov I.V.<sup>1</sup>, Kutyreva M.P.<sup>1</sup>*

<sup>1</sup>Kazan Federal University, Kazan, Russia  
Postgraduate  
[vaaprytkov@gmail.com](mailto:vaaprytkov@gmail.com)

The introduction of green chemistry approaches is one of the promising directions in the development of technologies for the synthesis of nanomaterials for biomedicine [1]. Metal-polymer nanocomposites based on silver nanoparticles with pronounced antimicrobial activity are promising objects for medicine and pharmacology as a basis for the creation of multifunctional therapeutic and theranostic agents [2]. For these purposes, non-toxic biodegradable dendrite-like hyperbranched polyesters (HBPs) with 3D architecture and high stabilizing activity towards noble metal ions can be successfully used. The functionalization of these compounds with fragments that exhibit reducing activity towards silver ions under mild conditions makes it possible to avoid the use of additional reducing agents, which will increase the purity of the nanomaterial, reduce toxicity, and control the morphology and functional activity of the composite nanomaterial.

As part of the work, the synthesis of derivatives of hyperbranched dendritic-like polyesters of the second generation, functionalized with 3[(2-aminoethyl)amino]propionate - **G2-EDA** (amino group content  $14.7 \pm 0.2$  wt.%) and fragments of maleic acid monoester – **G2-estMA** (carboxyl content groups  $19.7 \pm 0.1$  wt%) was carried out. The synthesized hyperbranched polymers are water-soluble and have been used to synthesize silver-containing nanocomposites using synthetic green chemistry approaches.

A one-step method was developed for the synthesis of composite nanomaterials consisting of silver nanoparticles stabilized in nano-sized polymer aggregates **G2-EDA** and **G2-estMA** in an aqueous environment. Silver nitrate (**AgNO<sub>3</sub>**) was used as a precursor salt. It has been established that these HBPs act as reductants and stabilizers of silver nanoparticles: **G2-EDA** - under standard conditions, **G2-estMA** - under thermo- (60 - 100 °C) and photoinitiation (254 and 365 nm). Using UV/Vis and IR spectroscopy, the processes of formation of silver nanoparticles in nanocomposites were studied, and the influence of the molar ratios  $V_{Ag^+}:V_{EDA}$  and  $V_{Ag^+}:V_{MA}$  on the morphology of synthesized nanoparticles was determined. Based on UV/Vis and IR spectroscopy data, the possibilities of controlling morphology and rate of formation of nanocomposite particles in the temperature range of 25 - 50 °C for **G2-EDA** were assessed. The ability to control the morphology and rate of nanophase formation by varying the method (thermo-/photo-) and initiation [T, °C/ $\lambda_{init}$ ] parameters for **G2-estMA** was also studied. The aggregation activity of nanocomposites was studied using the nanotracking analysis method (NTA), and the concentrations and hydrodynamic diameters of metal-polymer aggregates were determined. Using transition electron microscopy (TEM) data, the morphology and size distribution of silver nanoparticles were determined. In this work, the optimal conditions for the formation of **Ag@G2-EDA** ( $V_{Ag^+}/V_{EDA} = 1:5, 1:4$  и  $1:2$  at  $T_{synth} = 25^\circ C$ ;  $2:1 - 4:1$  at  $T_{synth} = 50^\circ C$ ) and **Ag@G2-estMA** ( $V_{Ag^+}:V_{MA} = 1:70, 1:50, 1:28, 1:12, 1:4$  at  $T = 100^\circ C$  under thermal initiation conditions and  $\lambda = 365$  nm for photoinitiation) were determined.

The synthesized metal-polymer nanocomposites have plasmonic activity and can be used in medicine as theranostic agents with antibacterial and antimycotic activity, as well as SERS substrates for the selective detection of proteins.

## References

- [1] *Current Research in Green and Sustainable Chemistry* **2021**, 4, 100205
- [2] *Drug Resistance Updates* **2023**, 68, 100935

## Acknowledgements

The work was carried out with the support of the academic leadership of the Kazan (Volga region) Federal University "Priority-2030". This work was supported by the Russian Science Foundation (project No 22-73-10036).

## MULTIFUNCTIONAL SORBENT/PHOTOCATALYST MATERIALS BASED ON Mg-Al LAYERED DOUBLE HYDROXIDES

*Rashitova K.I.<sup>1</sup>, Gerasimov S.A.<sup>1</sup>, Bobrysheva N.P.<sup>1</sup>, Osmolowsky M.G.<sup>1</sup>, Osmolovskaya O.M.<sup>1</sup>*

<sup>1</sup> St. Petersburg State University, St. Petersburg, Russia

Student, First-Year Master's Degree

[rashitovaki@gmail.com](mailto:rashitovaki@gmail.com)

The purification of industrial wastewater containing ions of toxic heavy metals ( $\text{Cu}^{2+}$ ,  $\text{Co}^{2+}$ ,  $\text{Ni}^{2+}$ ,  $\text{Fe}^{3+}$  and  $\text{Pb}^{2+}$ ), as well as various cyclic organic compounds, remains a great challenge in the point of view of modern pollution rates of natural objects. This problem leads to a decrease of the surface waters ecological status and a decrease in the quality of drinking water.

To solve the stated problem various strategies were proposed such as membrane technologies, ion exchange and chemical precipitation followed by filtration are used to remove heavy metal ions from wastewater. However, these approaches are either too expensive or not effective enough at low concentrations of metal cations. In this regard, the use of cheap and effective sorbents for ion removal becomes a promising alternative.

Nowadays, photocatalysis is considered one of the optimal methods for the decomposition of organic pollutants in water. Its advantages include cost-effectiveness, high efficiency and the ability to purify water without additional waste. However, most of the modern researches are devoted to studying materials photocatalytic efficiency on model systems. With transferring the proposed technology to real objects, it turns out that developed photocatalysts show low efficiency due to rapid contamination of the material surface with various ions, since real samples are complex multi-component systems.

To solve the problem of removing heavy metal ions and cyclic organic compounds from wastewater, we propose the use of layered double hydroxides (LDHs) as a multifunctional material that combines the functions of a sorbent and a photocatalyst. LDHs consist of the positively charged brucite-like layers and charge-compensating anions in the interlayer space. Due to their structure, LDHs can sorb ions in their interlayer space, preventing contamination of the surface of the photocatalyst, what is increasing the efficiency of wastewater treatment.

This work is devoted to the development of new multifunctional sorbents and photocatalysts; for this purpose, 3 samples of bare and copper and chromium doped layered double hydroxides MgAl, CuMgAl and CrMgAl were synthesized. The synthesis was carried out by co-precipitation at pH 10, followed by aging of the precipitate. X-ray diffraction (XRD) patterns show that all samples are crystalline phases of  $\text{Mg}_2\text{Al}(\text{OH})_7$ . It has been shown that doping leads to an increase in the distance between layers. FTIR spectra represents characteristic peaks of LDH with  $\text{NO}_3^-$  in the interlayer space. SEM micrographs with EDX element distribution maps and X-ray photoelectron spectroscopy results proved the uniform distribution of the dopant in the structure of the samples. The optical absorbance and transmittance spectra were used to evaluate the bandgap values of the samples.

Sorption of  $\text{Cu}^{2+}$ ,  $\text{Co}^{2+}$ ,  $\text{Ni}^{2+}$ ,  $\text{Fe}^{3+}$  and  $\text{Pb}^{2+}$  on LDH samples and the influence of various parameters (pollutants nature and concentration, pH, temperature, incubation time) on this process was studied. Optimal sorption conditions allow to achieved 90% removal of pollutants in an hour.

The screening of MgAl, CuMgAl and CrMgAl samples photocatalytic activity was conducted using the widely used model dyes under Vis irradiation. The process optimization (temperature, time, amount of photocatalyst) for CuMgAl sample, demonstrated the best result of dyes decomposition, demonstrated 58% of degradation through 60 min of irradiation.

Additionally, we demonstrated a possibility of simultaneous sorption of heavy metals and photocatalytic decomposition of an organic dyes.

### **Acknowledgements**

Scientific research was performed at the research park of St. Petersburg State University: Centre for X-ray Diffraction Studies, Chemical Analysis and Materials Research Centre, Centre for Physical Methods of Surface Investigation, Centre for Optical and Laser Materials Research and Interdisciplinary Resource Centre for Nanotechnology.

## SYNTHESIS AND ELECTROCHEMICAL PROPERTIES OF POLYNIMESALTMEN

*Rodionova U.M., Levin O.V., Kustin R.P., Filippova S.S.*

St. Petersburg State University, St. Petersburg, Russia

Student

[st113331@student.spbu.ru](mailto:st113331@student.spbu.ru)

At present, various types of portable electronic devices and electric vehicles widely use energy storage devices such as double-layer supercapacitors and lithium-ion batteries. However, due to their relatively short lifetime and hazardous use, it has become necessary to search for new energy storage materials, especially organic materials capable of reversible charge/discharge.

One such material may be polyNiMeSaltmen (N, N'-2,3-dimethylbutane-2,3-diyl-bis(3-methyl-salicylideneiminato) nickel (II) -  $[-\text{Ni}(\text{MeSaltmen})-]_n$ ), which belongs to the class of transition metal complexes with Schiff bases of the 'salen' type. Traditionally, the term 'salen' refers to a specific ligand prepared by condensation of two equivalents of salicylaldehyde and one equivalent of ethylenediamine, but it is now often used to refer to other similar ligands with different phenyl ring substituents and diamine backbones.

Salen ligands can be readily coordinated to a wide variety of transition metal ions to form stable coordinatively unsaturated metal complexes. In the present work, it is shown that polyNiMeSaltmen, in contrast to other representatives of salen complexes, has enhanced electrochemical stability in both non-aqueous and aqueous electrolytes. This is explained by the presence of four methyl groups at the imine bridge (-C=N-), which create steric hindrance for coordination of water molecules with  $\text{Ni}^{2+}$  ions.

Properties such as conductivity (in non-aqueous electrolytes and electrolyte containing 1% water), process kinetics have been studied using the CVA method. The stability of the properties is proven by the results of the tests carried out (Scheme 1).

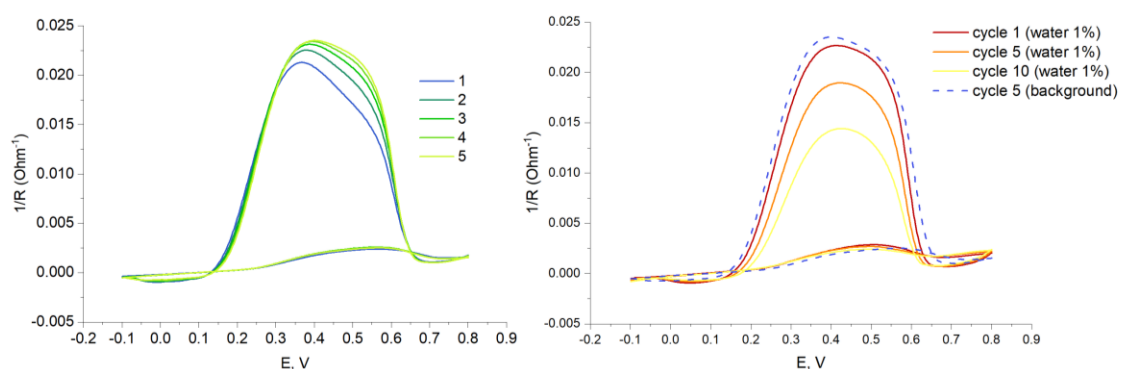

**Scheme 1.** Conductivity in dry electrolyte (left) and electrolyte with 1% of water (right) (electrolyte – 0.01 M polyNiMeSaltmen in 0.1 M TEABF<sub>4</sub>), E vs Ag/Ag<sup>+</sup>, 5 mV/s on Pt IDE

### Acknowledgements

This work was supported by the Russian Science Foundation (project No 22-43-04414).

# A TYPE II PHOTOINITIATOR FOR ACHIEVING EFFICIENT PHOTOCURING IN A SINGLE-COMPONENT SYSTEM

Saihe Yang<sup>1</sup>, Yifei Zhang<sup>2</sup>

<sup>1</sup>Dalian University of Technology, Dalian, China

<sup>2</sup>Saint Petersburg State University of Architecture and Civil Engineering, Saint Petersburg, Russia  
Student (speaker status, master's degree)

[zyf9313167098@yandex.ru](mailto:zyf9313167098@yandex.ru)

This investigation explores advancements in photocuring technology, distinguished by its 5E attributes: economical, efficient, enabling, environmentally friendly, and energy-saving. It utilizes ultraviolet light, visible light, or electron beams to swiftly convert photosensitive materials from liquid or semi-solid states into solid polymers through solidification and cross-linking. This technology is pivotal for fabricating advanced materials noted for their precision, rapid processing, and superior surface finishes. The study introduces a novel thioxanthone-based photoinitiator, TX-A4, which incorporates co-initiating groups to enhance the efficiency of LED-driven photopolymerization reactions and enable single-component polymerization. A comprehensive evaluation of its photophysical and photochemical properties, along with thermal stability and cytotoxicity, revealed that TX-A4 possesses a wide absorption spectrum, fast polymerization speed, high thermal stability, and low cytotoxicity. Moreover, both the polymerization rate and double bond conversion rate of TX-A4 are superior to those of the commercial photoinitiator ITX.

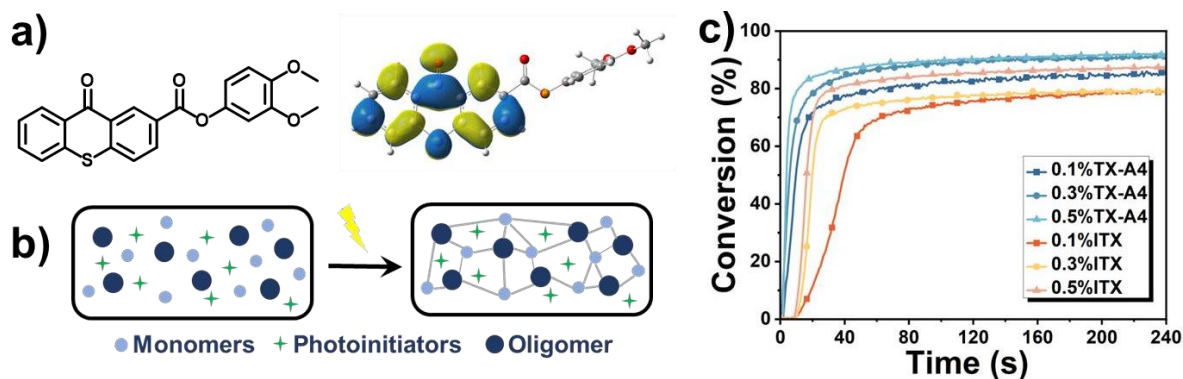

**Scheme 1.** a) The molecular structure and LUMO orbital of TX-A4; b) Schematic of the photocuring process; c) The double bond conversion rate of the monomer TPGDA initiated by TX-A4 and ITX.

## References

- [1] *Chemical Engineering Journal* **2023**, 477, 147104
- [2] *Polymer* **2019**, 174, 101–108
- [3] *Polymers* **2023**, 15, 342
- [4] *Dyes and Pigments* **2022**, 200, 110133
- [5] *Progress in Organic Coatings* **2022**, 167, 106859
- [6] *Polym. Chem.* **2015**, 6, 6595–6615
- [7] *Macromol. Chem. Phys.* **2016**, 217, 1501–1512

## Acknowledgements

The authors acknowledge the assistance of DUT Instrumental Analysis Center

## EXTRACTANT-CONTAINING MICROEMULSIONS BASED ON SODIUM DODECYL SULFATE FOR LEACHING OF NON-FERROUS METALS FROM ORE RAW MATERIALS

*Sharapova E.K.<sup>1,2</sup>, Murashova N.M.<sup>2</sup>*

<sup>1</sup> The Russian State Center for Animal Feed and Drug Standardization and Quality (VGNKI), Moscow, Russia

<sup>2</sup> Department of Nanomaterials and Nanotechnology, Mendeleev University of Chemical Technology of Russia, Moscow, Russia  
Post-graduate student  
[kate-dronova@ya.ru](mailto:kate-dronova@ya.ru)

The quality of ores has been continuously decreasing over the past decades. The solution to these problems is the development of new hydrometallurgical methods for ore processing. Thermodynamic stable nanostructured systems (for example, microemulsions) are promising materials for many branches of chemical industry, including hydrometallurgy. The method of microemulsion leaching was proposed, which involves selective extraction of metals from natural or anthropogenic raw materials by contacting them with an extractant-containing microemulsion. After leaching, the solid phase is separated and the target components are re-extracted by the introduction of mineral acid [1]. The main advantage of microemulsion leaching is the combination of the stages of leaching and extraction. In this work, the possibility of using reverse (water-in-oil) microemulsions in the system sodium dodecyl sulfate - extractant – 1-butanol - kerosene - water for metal leaching was evaluated.

Among the extractants of non-ferrous metals, carboxylic acids occupy one of the first places by their efficiency and extraction ability. On the model system of metal oxides (CuO, NiO, CoO, MnO, Fe<sub>2</sub>O<sub>3</sub>) the influence of different carboxylic acids on recovery factor of non-ferrous metals was compared. The model system of metal oxides was obtained by precipitation of aqueous solutions of their salts with 1 mol/L NaOH solution followed by washing, drying and calcination, its composition (g/kg): Cu - 186; Co - 164; Fe - 99; Mn - 210; Ni - 208. Monocarboxylic acids with short (acetic acid, C2, butyric acid, C4), medium (valerianic acid, C5, caproic acid, C6, caprylic acid, C8) and long (lauric acid, C12, oleic acid, C18) hydrocarbon chains were taken as extractants. Leaching was carried out with a combination of ultrasound (22 kHz, 10 W) and mechanical agitation (1000 rpm) at T=80°C and solid/liquid=1:50, metal re-extraction from the microemulsion was carried out with nitric acid solution. The content of metals in the re-extract was determined by ICP-MS (Agilent 7900).

The best results were shown by a microemulsion containing 2.0 mol/L caproic acid in the organic phase. The hydrodynamic diameter of the microemulsion droplets, determined by dynamic light scattering on a Zetasizer Nano ZS instrument (Malvern, UK), was 7.5±1.3 nm. The recovery of metals arranged as follows: Cu>>Mn>Ni≈Co>Fe, there is selectivity in the extraction of non-ferrous metals compared to iron, copper being extracted most effectively. The following recovery of metals, %, was achieved after 5 hours of leaching: Cu - 47.6, Mn - 12.8, Ni - 9.4, Co - 9.1, Fe - 4.3.

As an example of practical application, leaching of Cu, Co, Ni, Mn, and Fe from oxidized cobalt-copper concentrate using microemulsions containing caproic acid as an extractant was studied, as it showed high efficiency in metal leaching on the model system. The metal content in the concentrate was as follows (g/kg): Co - 87.0; Cu - 9.4; Ni - 4.0; Mn - 4.1; Fe - 107.0. The leaching results from cobalt-copper concentrate are similar to those obtained for the model system: active extraction of metals during the first hour, followed by a process at a roughly constant rate. Copper and cobalt are extracted most effectively, with the following recovery of metals achieved after 5 hours (%): Cu - 60.0, Co - 51.3, Mn - 16.5, Fe - 10.0, Ni - 9.3. According to these values, the metals are arranged as follows: Cu>Co>>Mn>Fe≈Ni, i.e., there is a separation of copper and cobalt from iron, nickel, and manganese. Increasing the concentration of caproic acid from 0.25 mol/L to 2.0 mol/L in the microemulsion resulted in increased extraction for copper from 12 to 60% and for cobalt from 17 to 51% (after 5 hours), while there was no change for nickel and iron.

To assess the influence of ultrasound power, leaching from oxidized cobalt-copper concentrate using microemulsions containing 2.0 mol/L caproic acid was conducted at the following powers: 10 W, 31.6 W, 63.1 W, 158.5 W. With an increase in ultrasound power, the extraction of manganese increased, while the extraction of cobalt, copper, and nickel remained practically unchanged.

Microemulsions containing caproic acid can be recommended for leaching metals from ores due to their high efficiency, selectivity in the extraction of Cu and Co over Fe, and the cost-effectiveness of the extractant (caproic acid).

### References

[1] *Hydrometallurgy*, 2018, **175**, 278.

## SYNTHESIS OF CRYSTALLINE CERIC PHOSPHATES OF A GIVEN MICROSTRUCTURE

*Sheichenko E.D.<sup>1,2</sup>, Tronev I.V.<sup>1,2</sup>, Vasilyeva D.N.<sup>1,2</sup>, Kozlova T.O.<sup>1</sup>*

<sup>1</sup> Kurnakov Institute of General and Inorganic Chemistry RAS, Moscow, Russia

<sup>2</sup> National research university «Higher School of Economics», Moscow, Russia

[esheichenko@igic.ras.ru](mailto:esheichenko@igic.ras.ru)

Crystalline ceric phosphates are regarded as a potential alternative to oxide materials employed in sunscreen cosmetics due to their biocompatibility and the high chemical and thermal stability of the phosphate matrix. The synthesis of crystalline ceric phosphates is typically conducted using methods that result in micron-sized particles. Given that the microstructure of materials can significantly influence their properties, including their photoprotective properties, this study explored the potential for directed modification of the material's structure, both through physical treatment (ultrasonication) and chemical modification. In the latter case, the method of homogeneous hydrolysis was realised in the process of hydrothermal synthesis of ceric phosphate ammonium-containing phases using hexamethylenetetramine (HMT) and urea as reagents.

On the example of crystalline ceric phosphates of the composition  $(\text{NH}_4)_2\text{Ce}(\text{PO}_4)_2 \cdot \text{H}_2\text{O}$ ,  $\text{NH}_4\text{Ce}_2(\text{PO}_4)_3$ ,  $\text{KCe}_2(\text{PO}_4)_3$  it was demonstrated that ultrasonic treatment of starting ceric phosphate gels with subsequent hydrothermal-microwave treatment allows the production of double ceric phosphates with the smallest crystallite sizes (approximately 60 nm) and the most narrow size distributions. For the first time, it has been demonstrated that the crystallite size of  $\text{NH}_4\text{Ce}_2(\text{PO}_4)_3$  and  $\text{KCe}_2(\text{PO}_4)_3$  affects their UV-shielding properties. It was observed that the values of the sun protection factor and protection factor against UV-A radiation increase as the mean particle size of the samples decreases, reaching values of approximately 4, which exceed previously published values for ceric compounds.

The potential for directional alterations in the microstructure of crystalline ceric phosphates of composition  $(\text{NH}_4)_2\text{Ce}(\text{PO}_4)_2 \cdot \text{H}_2\text{O}$  and  $\text{NH}_4\text{Ce}_2(\text{PO}_4)_3$  was explored by substituting the  $\text{NH}_4\text{OH}$  electrolyte used for gelling the ceric phosphate solution with HMT or urea at comparable concentrations. In the case of using HMT, the formation of the  $\text{NH}_4\text{Ce}_2(\text{PO}_4)_3$  phase was observed only at short synthesis times (up to 15 minutes) achieved by microwave heating of the reaction mixture. In contrast, under the conditions of conventional hydrothermal treatment (24 hours), the monazite phase was formed. The use of urea resulted in the formation of the  $\text{NH}_4\text{Ce}_2(\text{PO}_4)_3$  phase at low electrolyte concentrations (0.5 M) under hydrothermal synthesis conditions. Furthermore, the coherent scattering region size of the products obtained by the method of homogeneous hydrolysis was less than 100 nm.

### Acknowledgements

This work was supported by Russian Science Foundation (Grant no. 23-73-10088, <https://rscf.ru/en/project/23-73-10088/>)



## CO<sub>2</sub> ABSORPTION BY COMPOSITE MATERIALS BASED ON POLYETHYLENIMINE

*Sheshkovas A.Z.<sup>1</sup>, Veselovskaya J.V.<sup>1</sup>, Rogov V.A.<sup>1</sup>, Kozlov D.V.<sup>1</sup>*

<sup>1</sup>Boreskov Institute of Catalysis, Novosibirsk, Russia  
Postgraduate  
[sheshkovas@catalysis.ru](mailto:sheshkovas@catalysis.ru)

In recent years, much attention has been paid to reducing greenhouse gas emissions, in particular CO<sub>2</sub>. This interest is due to the increase in the concentration of CO<sub>2</sub> in the atmosphere, which negatively impacts the environment and human health. CO<sub>2</sub> can be removed from gas mixtures using a variety of sorption technologies. Nowadays, there are many absorption systems for capturing CO<sub>2</sub>, but they all have disadvantages, such as high volatility, high regeneration temperatures, and/or low CO<sub>2</sub> absorption capacities. In this paper, we consider a CO<sub>2</sub> chemisorbent devoid of these disadvantages based on the active component with a polymer structure, specifically, hyperbranched polyethylenimine (PEI). A large number of amino groups in the composition of PEI contribute to the high sorption capacity of the material (~365 mg(CO<sub>2</sub>)/g(PEI)), but this polymer is a viscous liquid, which results in a low rate of CO<sub>2</sub> absorption and makes it difficult to use PEI in its pure form. To improve the dynamics of chemisorption, PEI is dispersed using porous supports.

Porous Al<sub>2</sub>O<sub>3</sub>, SiO<sub>2</sub>, ZrO<sub>2</sub>-SiO<sub>2</sub> aerogels, and polymer matrices (PMMA, SDVB) were used as supports for PEI. The aim of the work was to study the dependence of their absorption characteristics on the choice of the support and the mass content of the PEI for the obtained composite materials. We synthesized composite sorbents by wet impregnation of the support using an alcoholic solution of PEI with a given concentration. First, the materials were dried in an oven at 50°C, and then at 100°C in a helium flow. We studied the CO<sub>2</sub> absorption and thermal characteristics of the obtained composite materials using the methods of thermogravimetric analysis (TGA) and differential scanning calorimetry (DSC). The CO<sub>2</sub> absorption capacity of the materials was determined at 30°C using a gas mixture of CO<sub>2</sub> and He containing 15 vol% of carbon dioxide.

The acceptable content of PEI in the pores of the support (silica gel) was previously identified. This value is about 40 wt% PEI, which corresponds to 50% filling of the support volume. For materials with higher PEI loading, the CO<sub>2</sub> sorption efficiency decreases, presumably due to hindered gas diffusion.

Next, CO<sub>2</sub> sorption experiments were carried out for composite materials based on various porous supports with the same PEI content (40 wt%). The enthalpy of CO<sub>2</sub> sorption for the studied composite sorbents ranged from 82 to 108 kJ/mol, which is typical for amine-containing CO<sub>2</sub> chemisorbents. It has been established that the sorption capacity correlates with the proportion of free pore volume in the composite (measured by low-temperature nitrogen porosimetry). Materials with a high proportion of free pore volume demonstrate optimal distribution of the active component in the pore space, which makes it possible to obtain high sorption capacity values. Based on the results obtained, we can assume that the effectiveness of CO<sub>2</sub> sorption depends on both the porous structure of the support and the chemical composition of its surface. Based on the results of the investigation, the most effective supports for PEI were determined: PMMA and SDVB. Thus, the efficiency of using the active component in SDVB pores reaches a value of 339 mg(CO<sub>2</sub>)/g(PEI), while the proportion of free pore volume in the resulting composite is 70%.

Testing of the 40%PEI/SDVB material in adsorption cycles "sorption (30 °C)/desorption (100 °C)" showed its stability (99% of the initial sorption capacity is preserved in 10 cycles). The heat consumption for the regeneration of the sample, according to calculations, amounted to ~2.9-3.5 GJ/t(CO<sub>2</sub>), which is significantly lower than for traditional methods of water-amine purification (4.2 GJ/t(CO<sub>2</sub>) [1]). It can be concluded that the obtained materials are promising for use in CO<sub>2</sub> capture technologies due to their high sorption capacity, stability, and low energy costs for regeneration.

### References

[1] *Int. J. Greenhouse Gas Control*. **2010**, 4, 486

### Acknowledgements

The work was supported by the Russian Science Foundation (grant № 23-23-10080, <https://rscf.ru/project/23-23-10080/>) and the Novosibirsk Region (agreement № r-47 dated 04/03/2023).

## APPLICATION OF $Ti_3C_2T_x/Fe_3O_4@PAA$ NANOCOMPOSITE FOR WATER PURIFICATION FROM METHYLENE BLUE DYE

*Shilov N.R.<sup>1</sup>, Aga-Tagiyeva S.E.<sup>1</sup>, Ni V.A.<sup>1</sup>, Magomedov K.E.<sup>1</sup>, Sobolev K.V.<sup>2</sup>, Rodionova V.V.<sup>1</sup>*

<sup>1</sup>Immanuel Kant Baltic Federal University, Kaliningrad, Russia

<sup>2</sup>Ben Gurion University of the Negev, Be'er Sheva, Israel

Student

[nikolayshilov2002@gmail.com](mailto:nikolayshilov2002@gmail.com)

MXenes are a novel class of two-dimensional materials with the general formula  $M_{n+1}X_nT_x$ , where M is a transition metal, X is either C or N, and  $T_x$  is a surface functional group, usually  $-OH$ ,  $-O$  or  $-F$ ; n is an integer index that typically takes the value from 1 to 3.[1] MXenes have found wide applicability in various fields (biomedicine, energy harvesting, environmental remediation, electronics, etc.) due to their unique properties: metallic conductivity, high hydrophilicity, large specific surface area, and its negative charge.[2] Moreover, MXenes can be controllably functionalized, which provides the possibility to enhance its existing properties or induce the new ones. Due to the negatively charged surface with multiple adsorbing centers, MXenes are used to adsorb heavy metals, dyes, and antibiotics from water while exhibiting giant sorption capacity.[3],[4],[5] Due to the fact that MXenes are hydrophilic they are difficult to remove from water, they can be placed into porous polymer matrices, or the purified water should be additionally filtered to remove MXenes. Functionalization of MXenes with magnetic nanoparticles makes it easy to purify water from the spent adsorbent, by means of magnetic decantation.

In this work, a new method of functionalization of  $Ti_3C_2T_x$  MXenes with magnetite ( $Fe_3O_4$ ) magnetic nanoparticles is employed, where multilayer MXenes are used as a nucleation sites for the nanoparticles growth.[3] As a result, single-layer  $Ti_3C_2T_x$  MXenes coated with magnetite nanoparticles are obtained. This method allows to increase the yield of single-layer MXenes, as well as to reduce the cost of their production. Such obtained nanocomposite material was used an adsorbing agent to eliminate the presence of methylene blue (MB) dye in water. To enhance the adsorptive properties of the composite, it was coated with polyacrylic acid, which demonstrated high selectivity towards MB. Coated nanoparticles exhibit perspective as potential candidates for sorption applications due to their water dispersibility, stability in aqueous environments, and significantly strong magnetic properties at room temperature. This is particularly important in water pollution control, where sorption is a critical process. The prepared  $Ti_3C_2T_x:Fe_3O_4$  nanocomposite was characterized using XRD, VSM, FTIR, TEM and DLS. The theoretical capacity of 10000 mg(MB)/g(MXenes) was calculated. Further research will focus on the use of surface-functionalized magnetic nanoparticles for this purpose.

### References

- [1] M. Naguib, V. N. Mochalin, M. W. Barsoum, and Y. Gogotsi, "25th anniversary article: MXenes: a new family of two-dimensional materials," *Adv Mater*, vol. 26, no. 7, pp. 992–1005, Feb. 2014, doi: 10.1002/ADMA.201304138.
- [2] M. Khazaei, A. Mishra, N. S. Venkataramanan, A. K. Singh, and S. Yunoki, "Recent advances in MXenes: from fundamentals to applications," *Curr Opin Solid State Mater Sci*, vol. 23, no. 3, pp. 164–178, Jan. 2019, doi: 10.1016/j.cossms.2019.01.002.
- [3] K. Sobolev *et al.*, "Iron Oxide Nanoparticle-Assisted Delamination of  $Ti_3C_2T_x$  MXenes: A New Approach to Produce Magnetic MXene-Based Composites," *Nanomaterials 2024, Vol. 14, Page 97*, vol. 14, no. 1, p. 97, Dec. 2023, doi: 10.3390/NANO14010097.
- [4] I. Ijaz *et al.*, "Functionalization of chitosan biopolymer using two dimensional metal-organic frameworks and MXene for rapid, efficient, and selective removal of lead (II) and methyl blue from wastewater," *Process Biochemistry*, vol. 129, pp. 257–267, Jun. 2023, doi: 10.1016/J.PROCBIO.2023.03.029.
- [5] S. Kashif, S. Akram, M. Murtaza, A. Amjad, S. S. A. Shah, and A. Waseem, "Development of MOF-MXene composite for the removal of dyes and antibiotic," *Diam Relat Mater*, vol. 136, p. 110023, Jun. 2023, doi: 10.1016/J.DIAMOND.2023.110023.

### Acknowledgments

This work was supported by the Russian Science Foundation, grant №22-12-20036.

# SYNTHESIS OF PERFORATED ZINC OXIDE NANOSHEETS WITH THE ASSISTANCE OF REACTIONS AT THE AQUEOUS SOLUTION OF ZINC SALT - ETHYLENEDIAMINE (AIR) INTERFACE

*Shilovskikh E.E.<sup>1</sup>, Meleshko A.A.<sup>1</sup>*

<sup>1</sup> St. Petersburg State University, St. Petersburg, Russia  
Student  
[evelina14shilovskikh@gmail.com](mailto:evelina14shilovskikh@gmail.com)

Zinc oxide-based compositions are widely used as bioactive materials, as they demonstrate anti-inflammatory, antifungal, and antibacterial action and promote wound healing. The optical and semiconducting properties of the ZnO are in demand for the creation of transparent electrodes, gas sensors, solar cells, photocatalysts, electronic and electrochemical devices. Several applications require the material to have a large surface area. A significant increase in the value of a specific surface area is observed when moving from bulk to nanomaterials, primarily with 2D morphologies such as perforated nanosheets. In addition to an increase in surface area, materials with such morphologies often exhibit a change in functional characteristics, and new promising properties emerge [1].

A top-down approach based on block crystals splitting into separate layered fragments is widely used to produce nanosheets. High-temperature bottom-up synthesis methods, such as atomic layer or gas-phase deposition, are also used. At the present stage of development of science and technology, nature-like methods of "soft" chemistry, which make it possible to produce new nanomaterials at room temperature and atmospheric pressure, without energy-intensive facilities, are increasingly in demand. Earlier, during the synthesis of some metal oxides by the action of gaseous NH<sub>3</sub> on the surface of an aqueous salt solution, it was shown that, when synthesis is carried out at the liquid-gas interface with a separate supply of reagents in the reaction zone, unique conditions can be realized that contribute to the production of materials with 2D morphology [2]. The developed synthesis method provides an opportunity to obtain complex metal oxides [3] and composite materials [4]. The prerequisite for the present work was the hypothesis that the interaction of organic reagents in the gaseous aggregate state with the surface of an aqueous salt solution can produce hybrid or complex compounds. This work aims to investigate the possibility of synthesis of zinc oxide nanosheets with the participation of reactions at the interface aqueous solution of zinc salt-gaseous ethylenediamine in an air atmosphere.

The report presents the results of the synthesis and characterization of zinc oxide with the morphology of perforated nanosheets, as well as the results of their photocatalytic properties studies. For the first time, we found conditions for the interfacial synthesis of nanosheets of hydroxide zinc acetate containing ethylenediamine groups in its composition. The thickness of nanosheets does not exceed 10 nm, and as a result of heat treatment they become perforated.

The obtained compounds may find application in the design of new biomedical materials and environmental protection technologies. The proposed synthesis method can serve as a basis for developing routes for obtaining new hybrid materials.

## References

- [1] *Russ. Chem. Rev.* **2023**, 92 (3), RCR5071.
- [2] *Prog. Nat. Sci.: Mater. Int.* **2020**, 30 (3), 279-288.
- [3] *Russ. J. Inorg. Chem.* **2024**, 69 (3), in press.
- [4] *Nanosystems: Phys. Chem. Math.* **2024**, 15 (1), 98-103.

## Acknowledgements

This work was supported by the Russian Science Foundation (project No 23-23-00060).

# EFFECT OF THE $\text{SiO}_2/\text{GeO}_2$ RATIO IN THE $\text{Na}_2\text{O}-\text{B}_2\text{O}_3-\text{SiO}_2-\text{GeO}_2$ SYSTEM ON THE CHARACTERISTICS OF POROUS GLASSES.

*Shiribazarova E. B.<sup>1,2</sup>, Korobatova N. M.<sup>1</sup>, Koroleva O. N.<sup>1</sup>*

<sup>1-</sup> Institute of Mineralogy SU FRC MG UB RAS, Miass

<sup>2-</sup> Lomonosov Moscow State University, Faculty of Fundamental Physical and Chemical Engineering, Moscow

Student

[eshiribazarova@bk.ru](mailto:eshiribazarova@bk.ru)

Porous glasses (PGs) comprise a distinct class of nanostructured materials, whose frame is formed by a glass skeleton, having distinct physical and chemical properties. The microstructure of PGs is characterised by the presence of branched channels. Depending on the synthesis method and the initial composition, their pore diameter varies from several angstroms to hundreds of nanometres. These can be used in the production of catalysts and electrochemical energy storage devices, employed for various sensing functions, and used as sorbents, membranes, matrices for nanocomposites, as well as in biomedical applications [1–4]. Nanoporous borosilicate glasses can also potentially be used as containers for the disposal of radioactive waste [5].

The main purpose of this work is to determine the effect of the  $\text{SiO}_2/\text{GeO}_2$  ratio in the  $\text{Na}_2\text{O}-\text{B}_2\text{O}_3-\text{SiO}_2-\text{GeO}_2$  system on the porous characteristics of glasses. To do this, is necessary to establish the influence of initial glass structure on the characteristics of the porous material. Here, the assessment of the pore diameter changing with replacing silicon oxide with germanium oxide in the absence of alkaline etching is of particular interest. The content of germanium oxide in the glasses varies from 14 up to 55 mol.%. Germanium oxide completely replaces silicon oxide in the composition of the initial glass with a  $\text{GeO}_2$  content of 55 mol.%.

As a result of the research, the substitution of silicon oxide with germanium oxide in the composition of the initial glass is shown to have a significant effect on the characteristics of the porous material obtained from it. The increase in the specific surface area and pore volume is associated with structural changes occurring in the initial glasses with the gradual replacement of  $\text{SiO}_2$  by  $\text{GeO}_2$ . Raman spectroscopy demonstrated that an increase in the number of highly coordinated germanium atoms occurs in the system. The transition  $^{[4]}\text{Ge} \rightarrow ^{[6]}\text{Ge}$  leads to spatial changes in the grid, a decrease in the number of non-bridge oxygen atoms and consequent elongation of channels in the future porous glass. In addition, an increase in the coordination number of germanium atoms contributes to an increase in the density of the phase forming the skeleton of the porous material. When replacing silicon with germanium in the  $\text{Na}_2\text{O}-\text{B}_2\text{O}_3-\text{SiO}_2$  system, an increase in the diameter of mesopores is observed when only acid leaching is used during synthesis; this is presumably due to the absence of secondary germanium.

Based on the obtained results, it can be argued that the characteristics of porous materials, which depend on the composition and structure of the initial glass, can be controlled already at the synthesis stage. A change in the  $\text{SiO}_2/\text{GeO}_2$  ratio leads to variations in both the specific surface area of PGs and porosity, as well as affecting the diameter of mesopores.

## References

- [1] Materials Chemistry and Physics. 2020, 242,122511.
- [2] J. of Non-Cryst. Solids. 2021, 554, 120598.
- [3] Optics & Laser Technology. 2022,147, 107658.
- [4] J. Phys.: Conf. Ser. 2022, 2169
- [5] US Patent No. 4,224,177, 1980

## Acknowledgements

Financial support of the work was provided by the Russian Science Foundation No. 22-17-20005 (<https://rscf.ru/project/22-17-20005/>).

## STRUCTURAL FEATURES OF CATIONIC LIPIDS FOR LIPID NANOPARTICLES FORMATION

*Shmykov B.D., Zaborova O.V.*

Moscow State University, Moscow, Russia

1<sup>st</sup> year PhD student

[bogdanshmykov@mail.ru](mailto:bogdanshmykov@mail.ru)

Lipid nanoparticles (LNPs) are spherical nanometer-sized particles widely used as delivery vehicles for bioactive molecules of various natures, including hydrophilic nucleic acids (RNA or DNA). Classic LNPs consist of four components: phospholipid, cholesterol, lipid conjugated with polyethyleneglycol (lipid-PEG) and an ionizable cationic lipid. The mixing of these components contributes to the formation of a stable dispersion of particles with a narrow monomodal size distribution and high RNA loading [1-3].

One of the promising areas of research for LNP is the search for new ionizable lipids that can improve the characteristics of particles. However, most studies are based on random selection of the lipid structure, or on minimal modification of existing ones. Therefore, the purpose of this work is to determine the necessary structural characteristics of cationic lipids for lipid nanoparticles.

The lipid mixture used for siRNA delivery was selected for the investigation: C12-200 / cholesterol / DSPC / C14-PEG = 50 / 38.5 / 10 / 1.5 (molar fractions) [1]. Cationic surfactants with different hydrocarbon tail structures were used to replace C12-200: oleylamine (OA), cetyltrimethylammonium bromide (CTAB), dodecyltrimethylammonium bromide (DTAB), dilauryldimethylammonium bromide (DLDMAB), distearoyldimethylammonium bromide (DSDMAB). Physico-chemical properties, such as size, surface charge and aggregation stability, of obtained LNPs were determined. LNPs were visualized using high-angle-annular dark-field scanning transmission electron microscopy (HAADF-STEM).

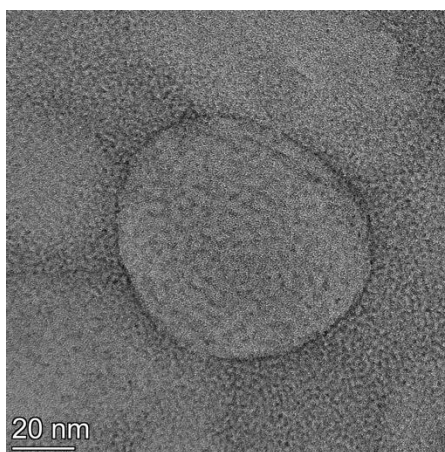

**Figure 1.** HAADF-STEM image of LNP

### References

- [1] Kulkarni J.A. et al. *Spontaneous, solvent-free entrapment of siRNA within lipid nanoparticles // Nanoscale.* **2020.** Vol. 12, № 47. P. 23959–23966;
- [2] Aldosari B.N., Alfagih I.M., Almurshedi A.S. *Lipid nanoparticles as delivery systems for RNA-based vaccines // Pharmaceutics.* **2021.** Vol. 13, № 2. P. 1–29;
- [3] Evers M.J.W. et al. *State-of-the-Art Design and Rapid-Mixing Production Techniques of Lipid Nanoparticles for Nucleic Acid Delivery // Small Methods.* **2018.** Vol. 2, № 9. P. 1700375.

### Acknowledgements

The work was carried out on the state budget subject of research (CITIS number: 121031300084-1).

# NANOZYMES "ARTIFICIAL PEROXIDASE" FOR THE SUPPRESSION OF REACTIVE OXYGEN SPECIES

Shneiderman A.A.<sup>1</sup>, Komkova M.A.<sup>1</sup>, Karyakin A.A.<sup>1</sup>

<sup>1</sup>Moscow State University, Moscow, Russia

Graduate student

[aleshneiderman@gmail.com](mailto:aleshneiderman@gmail.com)

Nanoparticles with enzyme-like catalytic activity and high stability, also known as nanozymes, have a huge advantage in eliminating the reactive oxygen species (ROS) therefore being attractive for applications in ROS-related disease therapy and engineering of drug delivery materials. To be applicable in therapy such nanozymes should be not only highly effective but also safe for the patient. Nanozymes based on Prussian blue combine both of these properties, unlike the numerous inorganic analogues described in the literature. Being highly effective mimetic of the peroxidase [1], which catalyzes reaction of hydrogen peroxide reduction, Prussian blue is also included in the list of medicines approved by the World Health Organization [2].

For the design of nanozymes based on Prussian blue the approach of catalytic synthesis is of greatest interest. The controlled reduction of the complex  $\text{Fe}^{\text{III}}[\text{Fe}^{\text{III}}(\text{CN})_6]$  with hydrogen peroxide promotes the growth of the most catalytically active structures and also makes it possible to control the size of obtained nanoparticles precisely. We investigated the effect of the catalytic reaction conditions and nanoparticles size on the effectiveness of such nanozymes.

Using approaches of steady-state kinetics the catalytic constants ( $k_{\text{cat}}$ ) of the hydrogen peroxide reduction catalyzed by nanozymes of different sizes were estimated. It was found that  $k_{\text{cat}}$  calculated for a single active site decreases with increasing nanozyme size.

The study was conducted for catalytic reactions in the presence of substrates with different redox potentials ( $E_0'(S_{\text{Ox}}/S_{\text{Red}})$  from 0.21 V for  $\text{K}_4[\text{Fe}(\text{CN})_6]$  to 0.50 for 3,3',5,5'-tetramethylbenzidine). It is shown that the relative change of the catalytic constant depending on the size is the more significant the lower the redox potential of the substrate. For example, with increasing nanoparticle size from 30 to 360 nm  $k_{\text{cat}}$  decreases by an order of magnitude in case  $\text{K}_4[\text{Fe}(\text{CN})_6]$  used as a substrate, but only twice in case of catechol. This result, on the one hand, indicates limited diffusion in the bulk of the largest ensembles of nanostructures, on the other hand, confirms that the catalysis proceeds under stronger mass transfer limitations when low-potential substrates are used.

The catalytic activity of catalytically synthesized Prussian Blue nanoparticles was compared with the most common nanozymes described in the literature. It is shown that  $k_{\text{cat}}$  of Prussian Blue nanozymes is more than an order of magnitude higher than for the transition metal oxides (Fe, Mn, Ce) and other Fe-NC catalysts. At the same time, the obtained activation energies of catalytic reaction, calculated according to the Arrhenius equation, are significantly lower than for other nanozymes described in the literature (up to 5 times lower compared to the  $\text{Fe}_3\text{O}_4$  nanozymes).

Such a high catalytic activity of Prussian blue-based nanozymes, in comparison with other materials, is of great interest for applications of ROS suppression. It has been demonstrated that Prussian blue nanozymes are not cytotoxic up to a concentration of 100  $\mu\text{M}$ . By the method of flow cytometry, it was found that incubation of mouse macrophages cells in the presence of nanozymes leads to a decrease in the level of reactive oxygen species. Increase in the concentration of the material leads to the increase of ROS suppression effectiveness. The maximum level of ROS reduction is 65%, achieved when the Prussian blue concentration more than 11  $\mu\text{M}$ .

## References

- [1] M.A. Komkova et al., *Journal of the American Chemical Society*, 2018, **140**, 11302.
- [2] World Health Organization, Model list of essential medicines - 22nd list. 2021.

## Acknowledgements

This work was supported by the Russian Science Foundation (project No 24-73-10015).

## CRYOCHEMICAL SYNTHESIS OF MAGNETIC IRON OXIDE NANOPARTICLES AND THEIR HYBRID SYSTEMS WITH CHLORAMPHENICOL

*Shumilkin A.S.<sup>1</sup>, Vernaya O.I.<sup>1,2</sup>, Semenov A.M.<sup>3</sup>, Shabatina T.I.<sup>1,2</sup>*

<sup>1</sup>Lomonosov Moscow State University, Chemistry Department, Moscow, Russia

<sup>2</sup>Bauman Moscow State Technical University, Moscow, Russia

<sup>3</sup>Lomonosov Moscow State University, Biology Department, Moscow, Russia

[alexpard99@gmail.com](mailto:alexpard99@gmail.com)

During the last decade, science and engineering have seen a rapid increase in interest for nanoscale materials with dimensions less than 100 nm. Nanoparticles, due to their submicroscopic sizes intermediate between atoms and bulk (solid) materials, have unique characteristics, primarily, a large surface area per volume unit, a high proportion of surface and near-surface atoms. Magnetite and maghemite nanoparticles also possess the unique magnetic and thermal properties, easily separation, low toxicity and biocompatibility. Magnetic iron oxides nanoparticles currently have immense potential as magnetic vectors for directed drug delivery and carriers, magnetic agents for MRI and magnetic hyperthermia. They are used for magnetic cell labeling separation and tracking in tissue engineering and clinical diagnostic. If the size of these particles decreases below the critical size of the magnetic domain, they will transfer into a superparamagnetic state. Superparamagnetic nanoparticles are characterized by a high value of saturation magnetization, the absence of residual magnetism and a high magnetocaloric effect. In addition, superparamagnetic particles smaller than 10 nm are optimal agents for MRI, as they are T<sub>1</sub> contrast agents, unlike larger particles [1,2].

Cryochemical technologies in the case of nanomaterials production make it possible to increase the environmental friendliness of the synthesis and obtain materials with different dimensional and structural characteristics. In the course of this work, particles of magnetic iron oxides of various sizes and structures were obtained, by varying the conditions of cryochemical synthesis. Spray freeze-drying methods were applied to aqueous solutions of iron salts (iron III acetylacetonate, iron II formate, iron III citrate, iron II glucognate) followed by thermal decomposition of the resulting precursors making it possible to obtain maghemite particles from tens of nanometers in size (in the case of iron II formate and iron III acetylacetonate), to micron lamellar (in the case of iron III citrate) and porous structures (in the case of iron II glucognate) structures.

Cryochemical coprecipitation of divalent and trivalent iron salts makes it possible to reduce the average size of the resulting magnetic iron oxide nanoparticles from 17 (the case of classical coprecipitation) to 6 nm. However, in this case, in addition to the main metal oxide products, goethite with undesirable magnetic properties is also formed. The deposition of iron II sulfate from the surface of cryogranules makes it possible to obtain nanopowder of magnetic iron oxide, freed from the admixture of goethite particles.

Low-temperature technologies make it possible to obtain not only nanoparticles, but also hybrid materials. Magnetite nanoparticles obtained by cryochemical method were included in chloramphenicol based nanocomposite. The resulting hybrid particles had an average size of 50-400 nm, including magnetite nanoparticles with an average size of less than 10 nm, as in the precursor used. The resulting systems showed higher dissolution rates and saturation solubility than for the original pharmacopoeia bulk preparation. For the nanosystems obtained the antibacterial activity against *E. coli* and *S. aureus* was determined both by kinetic methods determining the inhibition constants and minimal inhibition concentration (MIC). It has been established that the simultaneous presence of magnetite and chloramphenicol in the nanosystems leads to a synergistic increase in their antibacterial activity.

### References

- [1] Magnetic nanoparticles for biomedical purposes: Modern trends and prospects / T. I. Shabatina, O. I. Vernaya, V. P. Shabatin, M. Y. Melnikov // *Magnetochemistry*. — 2020. — Vol. 6, no. 3. — P. 30.
- [2] Metal and metal oxides nanoparticles and nanosystems in anticancer and antiviral theragnostic agents/ T. I. Shabatina, O. I. Vernaya, N. L. Shimanovskiy, M. Y. Melnikov // *Pharmaceutics*. — 2023. — Vol. 15. — P. 1181.

# THE DESIGN OF ALKYL-SUBSTITUTED HOLE TRANSPORT MATERIALS FOR PEROVSKITE SOLAR CELLS

*Sideltsev M.E.*<sup>1</sup>, *Zhivchikova A.N.*<sup>1,2</sup>, *Kuznetsov I. E.*<sup>1</sup>, *Piryazev A.A.*<sup>1,3</sup>, *Nikitenko N.G.*<sup>1</sup>, *Akkuratov A.V.*<sup>1</sup>

<sup>1</sup> Federal Research Center of Problems of Chemical Physics and Medicinal Chemistry, Russian Academy of Sciences, Chernogolovka, Russia

<sup>2</sup> Skolkovo Institute of Science and Technology, Moscow, Russia

<sup>3</sup> Moscow State University, Moscow, Russia

Graduate Student

[sideltsev.max@yandex.ru](mailto:sideltsev.max@yandex.ru)

Organic semiconductor materials (OSM) have attracted a much attention from the scientific community due to their unique physicochemical and optoelectronic properties, which enable the fabrication of new generation of flexible electronic devices. OSMs have great potential as hole transport materials (HTMs) for perovskite solar cells (PSC) providing higher device stability by encapsulating unstable perovskite [1] as well as higher performance by improving charge extraction from the photoactive layer [2]. Generally, the efficiency and stability of PSCs is determined by the morphology of HTM films, which in turn depends on the structure of the compounds [3].

Herein, we designed three donor-acceptor small molecules consisting of benzodithiophene, benzothiadiazole and thiophene moieties and investigated them as hole-transport materials in n-i-p perovskite solar cells (Figure 1).

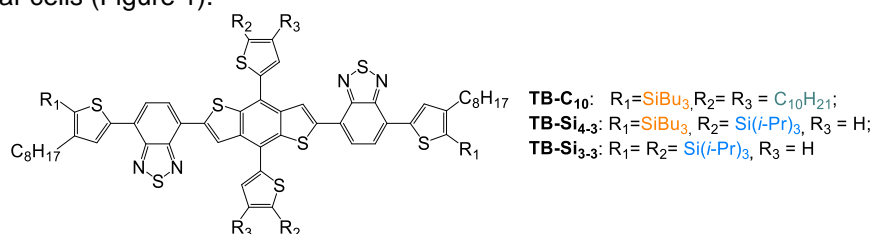

**Figure 1.** Chemical structure of investigated molecules.

The optoelectronic properties of materials indicate the prospects of their application in PSCs. The morphology, charge mobility, and charge extraction ability of developed molecules are shown to strongly depend on the shape and number of alkylsilyl side groups. The replacing Bu<sub>3</sub>Si groups with (*i*-Pr)<sub>3</sub>Si substituents ensured superior crystallinity and uniform surface morphology of films (Figure 2).

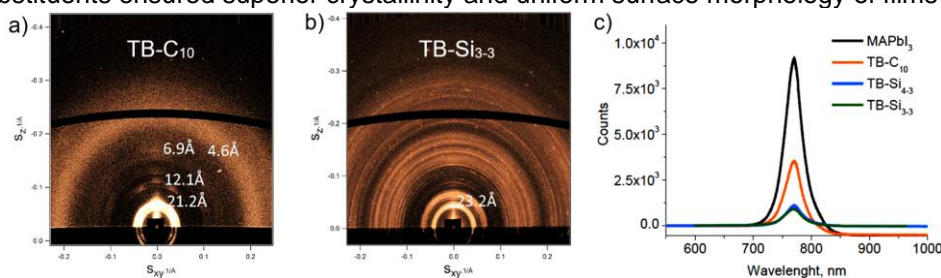

**Figure 2.** 2D GIWAXS images for films **TB-C<sub>10</sub>** (a) и **TB-Si<sub>3-3</sub>** (b) and PL spectra for MAPbI<sub>3</sub> and MAPbI<sub>3</sub>/HTM (c)

As a result, the optimized PSCs with TB-Si<sub>3-3</sub> comprising four peripheral (*i*-Pr)<sub>3</sub>Si-groups delivered the best power conversion efficiency of 16.8%. The results obtained suggest the great potential of alkylsilyl-substituted small molecules as dopant-free HTMs for perovskite photovoltaic applications.

## References

- [1] *DeCarbon*. **2023**, *1*, 100004
- [2] *Energy Environ. Sci.* **2020**, *13*, 4057
- [3] *Dyes Pigments*. **2021**, *195*, 109718

## Acknowledgements

This work was supported by the Ministry of Science and Higher Education of the Russian Federation, project No 122111700041-8 (FFSG-2022-0004).



# SURFACE-MODIFIED HIGH ENERGY DENSITY Ni-RICH LAYERED CATHODE MATERIALS FOR ADVANCED LITHIUM-ION BATTERIES

*Sitnikova L.A.*<sup>1</sup>, *Dolzhikova E.A.*<sup>1</sup>, *Savina A.A.*<sup>1</sup>, *Abakumov A.M.*<sup>1</sup>.

<sup>1</sup> Skolkovo Institute of Science and Technology, Moscow, Russia

1<sup>st</sup> year PhD Student

[Lyutsia.Sitnikova@skoltech.ru](mailto:Lyutsia.Sitnikova@skoltech.ru)

The demand for high-energy density Li-ion batteries (LIBs) increases with expanding their application from portable mobile devices towards electric vehicles and stationary energy storage systems<sup>1</sup>. The positive electrode (cathode) plays a key role in defining cost, capacity, cycling and thermal stability of LIBs. Ni-rich layered oxides  $\text{LiNi}_x\text{Mn}_y\text{Co}_z\text{O}_2$  ( $x + y + z = 1$ ,  $x \geq 0.6$ ), so-called Ni-rich NMCXYZ, have become one of the preferred cathode materials for advanced LIBs due to their high reversible electrochemical capacity, energy density and relatively low cost. The current trend is increase of the Ni fraction in Ni-rich NMCs, which leads to layered oxides with ultra-high Ni content ( $x > 0.85$ ) demonstrating discharge capacity as high as 230 mAh/g<sup>2</sup> and higher energy density ( $> 800$  Wh/kg). However, enhancing the Ni concentration not only boosts energy density, but also causes dramatic structure changes during electrochemical cycling compromising battery durability. Cracks are considered to be one of the main reasons for the rapid degradation of Ni-rich NMCs upon cycling<sup>3</sup>. These issues are mainly related to widely commercialized Ni-rich NMCs with spherical-like micrometer-sized agglomerates consisting of randomly oriented primary nanoparticles. In contrast, the radially oriented primary particles seemingly allow the cathode agglomerate to contract and expand uniformly, remarkably suppressing microcracks formation and, thereby, improving cycling stability<sup>4</sup>. This microstructure improves both rate capability by expediting Li migration and mechanical stability by alleviating the intergrain stress. Enhancing the concentration of Co on the surface of Ni-rich NMC can stabilise the cathode surface, form a less rigid surface, prevent the appearance of microcracks and improve the mechanical stability of Ni-enriched NMC<sup>5</sup>.

In this work, Co-modified Ni-rich NMCs with Ni  $> 85\%$  with remarkable electrochemical performance were obtained via combined gradient-composition and microstructural modification approaches. The synthesis route was based on microwave-assisted hydrothermal treatment of the  $\text{Ni}_{0.95}\text{Co}_{0.025}\text{Mn}_{0.025}(\text{OH})_2$  precursor with aqueous solution of  $\text{CoSO}_4$  and urea followed by a conventional high-temperature solid-state reaction with a Li source. The best electrochemical properties were observed for the material with the integral Ni:Co:Mn  $\sim 0.87:0.11:0.02$  ratio delivering the initial capacities of 215, 210, 199, 189, 178 and 160 mAh/g at C/10, C/5, C/2, 1C, 2C, and 5C rates, respectively, comparable or even superior than those for unmodified  $\text{LiNi}_{0.95}\text{Co}_{0.025}\text{Mn}_{0.025}\text{O}_2$  (221, 210, 194, 180, 163, 138 mAh/g). At the same time, the modified material demonstrates three times better cycling stability (capacity fade per cycle is  $0.04 \pm 0.01\%$  for the Co-modified material vs.  $0.13 \pm 0.02\%$  for  $\text{LiNi}_{0.95}\text{Co}_{0.025}\text{Mn}_{0.025}\text{O}_2$ ). The boost in capacity retention is attributed to the synergetic effect of the compositional gradient and resulting microstructure organization of radially oriented plate-like primary particles, which improves mechanical integrity of both primary crystallites and agglomerates.

## References

- [1] *Energy Environ Sci*, **2021**, *14*, 844–852.
- [2] *Nano Res*, **2022**, *15*, 9038–9046
- [3] *Advances and Perspectives*, **2017**, *Small* **13**, 1701802
- [4] *Journal of Energy Chemistry*, **2022**, *71*, 588–594
- [5] *Nat Commun*, **2021**, *12*, 6024.

## Acknowledgements

The study was supported by the Russian Science Foundation grant No. 23-73-30003, <https://rscf.ru/project/23-73-30003/>

# ENHANCING ANTIBIOTIC REMOVAL FROM WASTEWATER USING TIN DIOXIDE NANOPARTICLES OF VARIOUS SHAPE: INVESTIGATING THE IMPACT OF STRUCTURAL PARAMETERS ON PHOTOCATALYSIS

*Skripkin E.V., Podurets A.A., Osmolowsky M.G., Bobrysheva N.P.,  
Voznesenskiy A.M., Osmolovskaya O.M.*

St. Petersburg State University, St. Petersburg, Russia  
Bachelor Student  
[st087709@student.spbu.ru](mailto:st087709@student.spbu.ru)

Currently, water pollution by cyclic organic compounds (COCs) such as dyes and antibiotics poses a significant environmental threat. Antibiotics enter wastewater through various technological processes and adversely affect the ecological state of water resources, since many of them are toxic and mutagenic. Additionally, without proper treatment, sulfonamides can persist in the environment for extended periods due to their stability, exacerbating their harmful impact.

Cost-effectiveness, environmental friendliness, and the simplicity of implementation are crucial factors for effective water purification. In this context, the photodegradation of cyclic organic compounds (COCs) using wide band gap semiconductor nanoparticles (NPs) is gaining traction. Photocatalysis involves the accelerated degradation of complex COCs facilitated by reactive oxygen species generated in the aqueous medium when light interacts with the surface of wide band gap semiconductor nanoparticles.

Despite the extensive understanding of the photocatalysis process, achieving optimal efficiency in practical applications requires identifying the specific factors and material characteristics that influence this process. However, the existing literature on this topic is limited. Semiconductor particles are characterized by a wide range of parameters that affect their properties. To determine the key factors influencing photocatalytic activity, it is sensible to begin by studying nanoparticles with similar morphology (i.e., the same size and shape).

Among the numerous semiconductor materials that demonstrate significant activity under UV radiation, tin dioxide  $\text{SnO}_2$  stands out due to its rutile-type structure, n-type semiconductor properties, and a bandgap energy of 3.6 eV. This work focuses on developing an approach to regulate the structural parameters of nanoparticles and exploring their relationship with photocatalytic activity.

Spherical NPs were synthesized by co-precipitation method. The synthesis temperature and reaction media composition were varied to change the rate of NPs formation. All samples were characterized by physico-chemical methods in a combination with quantum chemical calculations.

The organic dye Methylene Blue (MB) solution was used as a model system to study the kinetics of photodegradation under UV radiation. The optimal sample demonstrated 95% MB decomposition in 7 minutes. Consequently, this sample, exhibiting the best photocatalytic efficiency, was then used to test the photodegradation of a widely used sulfonamide antibiotic. The study revealed that a mixture of sulfonamides degrades less efficiently than individual antibiotics. However, more than 90% of all components in the mixture degraded within 35 minutes. It was shown that the rate of the photocatalysis process is determined by the energetic benefit of the interaction between antibiotics and the photocatalyst surface.

Initial spherical blocks with various amounts of oxygen vacancies and defects were used for post-synthetic treatment under hydrothermal conditions (HTT) and investigated via oriented attachment (OA) mechanism. Consequently, the size of the resulting rod-shaped particles was determined by the favorable interaction of different numbers of initial blocks, as evidenced by the decrease in lattice parameters. It was demonstrated, that the surface composition affects the shielding capabilities of the reaction medium components. The optimal sample demonstrate 75% degradation of MB after 7 min.

In summary, the amounts of oxygen vacancies ( $V_o$ ) and structural defects (D) were calculated using our original approach based on XPS and Raman spectroscopy data. The effect of the  $V_o/D$  ratio on the photocatalytic activity of the  $\text{SnO}_2$  samples was established for the first time. The results showed that samples with a higher number of vacancies and fewer defects exhibited improved photocatalytic efficiency.

## Acknowledgements

This work was supported by the Russian Science Foundation (project No 23-23-00408). The author expresses his gratitude to the Resource Center of the Science Park of St. Petersburg State University: "Centre for X-ray Diffraction Studies", "Chemical Analysis and Materials Research Centre", "Centre for Optical and Laser Materials Research", "Centre for Physical Methods of Surface Investigation".

# SYNTHESIS, CRYSTAL STRUCTURE AND FUNCTIONAL PROPERTIES OF $\text{La}_{2-x}\text{A}_x\text{Ni}_{1-y}\text{Cu}_y\text{O}_{4+\delta}$ (A=Pr, Nd; x=0.5, 1.0, 1.5, y=0.4, 0.6, 0.8) AS CATHODE MATERIAL FOR SOFC

*Sobol M.E.*<sup>1</sup>, *Sukhanov K.S.*<sup>1</sup>, *Gilev A.R.*<sup>1</sup>, *Kiselev E.A.*<sup>1</sup>, *Cherepanov V.A.*<sup>1</sup>

<sup>1</sup> Ural Federal State University, Yekaterinburg, Russia

Student

[sobol2709@mail.ru](mailto:sobol2709@mail.ru)

Research related to the development of solid oxide fuel cells (SOFCs) is of great interest at present time. These devices produce electricity effectively without harming the environment. Decreasing the operating temperature from 800-1000 °C to 500-800 °C and choosing an electrode material with good performance characteristics are the main goals to improve the SOFC technology. In this respect the  $\text{Ln}_2\text{NiO}_{4+\delta}$  (Ln=La, Pr and Nd) complex oxides belonging to the Ruddlesden-Popper series,  $\text{Ln}_{n+1}\text{Ni}_n\text{O}_{3n+1}$ , where n = 1, have a number of advantages: high chemical stability, except for  $\text{Pr}_2\text{NiO}_{4+\delta}$ , mechanical compatibility with solid electrolytes, good oxygen-ion and electronic conductivity [1-2]. Thus, the purposes of the present work are to synthesize new  $\text{La}_{2-x}\text{A}_x\text{Ni}_{1-y}\text{Cu}_y\text{O}_{4+\delta}$  (A=Pr, Nd), (x=0.5, 1.0, 1.5, y=0.4, 0.6, 0.8) complex oxides, which should be stable at operating temperatures 500-800 °C showing acceptable electrochemical activity in oxygen oxidation-reduction reactions; to study their crystal structure, oxygen content, electrotransport properties and to estimate their performance as cathode materials.

The samples were synthesized by decomposition of citrate-nitrate precursors with the final annealing step at 900 °C for 12 hrs in air. All synthesized samples were identified to be single phase by X-ray powder diffraction and adopted the tetragonal  $\text{K}_2\text{NiF}_4$ -type structure (sp.gr. *I4/mmm*). Crystal structure parameters were refined by the Rietveld method using a *FullProf* package.

Oxygen content ( $4+\delta$ ) was determined for the  $\text{LaPrNi}_{0.6}\text{Cu}_{0.4}\text{O}_{4+\delta}$ ,  $\text{La}_{1.5}\text{Pr}_{0.5}\text{Ni}_{0.6}\text{Cu}_{0.4}\text{O}_{4+\delta}$ ,  $\text{La}_{1.5}\text{Pr}_{0.5}\text{Ni}_{0.4}\text{Cu}_{0.6}\text{O}_{4+\delta}$  samples by a thermogravimetric analysis which was implemented in the temperature range of 25-1100 °C in air followed by a reduction in hydrogen-nitrogen mixture. It was found that all samples showed excess in oxygen ( $\delta>0$ ) and no substantial changes in oxygen content were detected in the range of 25-350°C in air. The active oxygen release from the oxides to gaseous phase began at about 400 °C which could mainly be attributed to interstitial oxygen.

Total conductivity ( $\sigma$ ) and the Seebeck coefficient (S) of the  $\text{La}_{2-x}\text{A}_x\text{Ni}_{1-y}\text{Cu}_y\text{O}_{4+\delta}$  (A=Pr, Nd), (x=0.5, 1.0, 1.5, y=0.4, 0.6, 0.8) samples were measured by a DC four-probe technique and integral method respectively. Maximal value of 107 S/cm was obtained for the  $\text{LaNdNi}_{0.6}\text{Cu}_{0.4}\text{O}_{4+\delta}$  sample. In the series  $\text{La}_{2-x}\text{Pr}_x\text{Ni}_{1-y}\text{Cu}_y\text{O}_{4+\delta}$  (x=0.5, 1.0, 1.5, y=0.4, 0.6, 0.8), total conductivity increases with the increase in x and the decrease in y. Positive values of the Seebeck coefficient and relatively high total conductivity values showed that the main charge carriers should be positively charged electron holes. In the lower temperature interval (25-350°C), where the concentration of the main charge carriers did not change, the linear dependencies of  $\lg(\sigma T)$  and S vs.  $1/T$  were obtained. Positive values of activation energies  $E_\sigma$  and  $E_s$ , which were calculated from the corresponding slopes of the  $\lg(\sigma T)=f(1/T)$  and  $S=f(1/T)$  dependencies, and their difference  $W=E_\sigma - E_s$ , indicated that charge transfer was occurred by a small polaron hopping mechanism for all studied samples.

Polarization resistance ( $R_p$ ) of the  $\text{La}_{2-x}\text{A}_x\text{Ni}_{1-y}\text{Cu}_y\text{O}_{4+\delta}$  (A=Pr, Nd), (x=0.5, 1.0, 1.5, y=0.4, 0.6, 0.8) cathode materials in symmetrical cells with the  $\text{Ce}_{0.8}\text{Sm}_{0.2}\text{O}_{2-\delta}$  (SDC) electrolyte was determined by the Electrochemical Impedance Spectroscopy (EIS). It was found that the  $R_p$  value decreased with increasing x or y in the  $\text{La}_{2-x}\text{Pr}_x\text{Ni}_{1-y}\text{Cu}_y\text{O}_{4+\delta}$  series, and its value was equal to 0.07  $\Omega \text{ cm}^2$  for x=0.5, y=0.4; 0.05  $\Omega \text{ cm}^2$  for x=1.0, y=0.4 and 0.03  $\Omega \text{ cm}^2$  for x=1.5, y=0.4 at 800 °C. In the  $\text{La}_{2-x}\text{Nd}_x\text{Ni}_{1-y}\text{Cu}_y\text{O}_{4+\delta}$  series, copper doping level (y) increased polarization resistance from 0.081  $\Omega \text{ cm}^2$  (x = 1.0, y = 0.4) to 0.093  $\Omega \text{ cm}^2$  (x = 1.0, y = 0.6) at 800 °C.

## References

- [1] *Recent advances in layered  $\text{Ln}_2\text{NiO}_{4+\delta}$  nickelates: fundamentals and prospects of their applications in protonic ceramic fuel and electrolysis cells*, *J. Mater. Chem. A* 9 (2021) 154
- [2]  *$\text{Ln}_2\text{MO}_4$  cathode materials for solid oxide fuel cells*, *Sci. China Chem.* 54 (2011) 898.

## Acknowledgements

This work was supported by the Russian Science Foundation (project No 24-23-00128)

## SYNTHESIS AND STUDY OF THE THERMOSTABLE ALUMINUM OXIDE PROPERTIES FOR USAGE IN THREE-WAY CATALYSTS

*Solodovnikova P.A.<sup>1</sup>, Telegin T.E.<sup>1</sup>, Ugrumova M.V.<sup>1</sup>, Vostretsova D.A.<sup>2</sup>*

<sup>1</sup>Ural Federal University, Ekaterinburg, Russia

<sup>2</sup>Lyceum № 128, Ekaterinburg, Russia

Graduate student

[solly.polly@yandex.ru](mailto:solly.polly@yandex.ru)

Aluminum oxide is one of the most suitable materials for use as a catalyst support [1]. Methods for producing aluminum oxide make it possible to impart a developed porous morphology to its surface, which increases the activity of the catalyst [3].

Transition from the process of synthesis of a laboratory sample to the synthesis of a semi-industrial sample and obtaining a semi-industrial sample is an important intermediate step in the introduction of laboratory technology into industrial production. It is important to obtain a final product that satisfies the technical specifications and has the same characteristics as the laboratory sample.

During the work, aluminum hydroxides were synthesized by controlled double-jet deposition with their subsequent decomposition to oxides. At the same time, the influence of variable synthesis parameters was studied, such as: precipitation pH, percentage and method of introducing the modifier (lanthanum oxide), firing temperature, and composition of the feedstock.

The synthesis of an enlarged sample in the amount of 10 kg of the final oxide was carried out in a similar way; the synthesis parameters were chosen in accordance with the synthesis conditions of the laboratory sample. The essence of the process was to ensure that the characteristics of the resulting product from a large batch corresponded to the characteristics of the laboratory sample when scaling up the synthesis process.

The resulting samples were subjected to further studies: the surface and porosity of the samples were analyzed by nitrogen adsorption/desorption, X-ray phase analysis, and the viscosity of the samples in the working suspension was analyzed. Next, the enlarged sample was transferred to Ecoalliance LLC for testing as part of an automobile catalyst: a coating adhesion test was carried out, as well as a test under real operating conditions when operating an internal combustion engine.

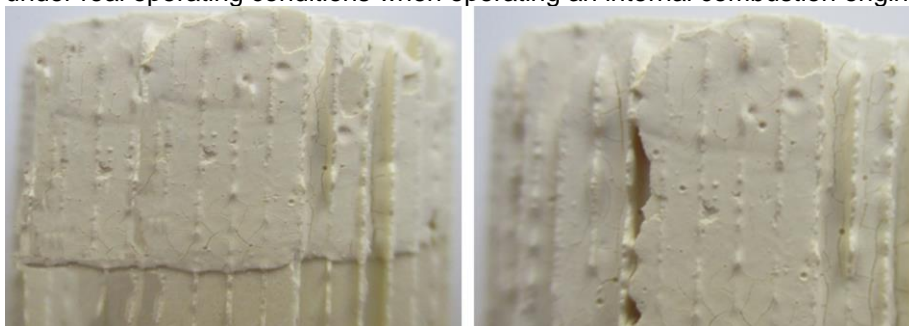

**Figure 1.** The result of the adhesion test of the working coating with the content of a laboratory sample (left) and for an enlarged one (right)

From the point of view of structure preservation (no cracks), the samples successfully passed the tests. The test results showed that the synthesis of a semi-industrial sample makes it possible to obtain samples of thermally stable aluminum oxide that meet the requirements of the technical specifications. The results obtained have practical application in the production of thermostable aluminum oxide at SAPFIR LLC - Chemical Technologies.

### References

- [1] Pakhomov N.A. *Scientific principles of catalyst preparation: introduction to theory and practice* / N.A. Pakhomov; resp. ed. V.A. Sadykov. Ross. acad. Sciences, Sib. department, Institute of Catalysis named after. G.K. Boreskova. - Novosibirsk: Publishing House SB RAS, 2011.
- [2] Chaly V.P. *Metal hydroxides* / Chaly V.P.—Kyiv: Nauk. Dumka, 1972 - 153 p.

### Acknowledgements.

The authors express their gratitude to the company Ecoalliance LLC and personally to engineer E.O. Baksheev. for assistance in testing samples as part of automotive catalysts.

# PHOTOACTIVE SELF-CLEANING MATERIALS MODIFIED WITH TiO<sub>2</sub>-N FOR DESTRUCTION OF CONTAMINANTS UNDER VISIBLE LIGHT

*Solovyeva M.I.*<sup>1,2</sup>, *Zhuravlev E.S.*<sup>3</sup>, *Stepanov G.A.*<sup>3</sup>, *Kozlova Y.N.*<sup>3</sup>, *Morozova V.V.*<sup>3</sup>, *Richter V.A.*<sup>3</sup>,  
*Kozlov D.V.*<sup>1,2</sup>, *Selishchev D.S.*<sup>1,2</sup>

<sup>1</sup> Borekov Institute of Catalysis SB RAS, Novosibirsk, Russia

<sup>2</sup> Novosibirsk State University, Novosibirsk, Russia

<sup>3</sup> Institute of Chemical Biology and Fundamental Medicine SB DAS, Novosibirsk, Russia

Graduate student

[smi@catalysis.ru](mailto:smi@catalysis.ru)

Self-cleaning materials are a promising technology for removing various harmful contaminants. It was shown that photoactive cotton fabric modified with nanocrystalline TiO<sub>2</sub> can oxidize dangerous chemical and biological contaminants such as viruses and bacteria under irradiation in UV-A range [1]. However, the sunlight contains only 5% UV-radiation. Therefore, it is necessary to develop self-cleaning materials using photocatalysts that are active under visible light to increase the efficiency of light usage.

The new method to obtain such materials included the following stages: preparation of a mixture consisting of nanocrystalline nitrogen-doped titanium dioxide [2], titanium (IV) isopropoxide [3] or silicon binder [4] fixing photocatalyst particles, and isopropyl alcohol as a solvent; addition of an acid and water to hydrolyze the binder; addition of copper (II) acetate to increase the charge separation; impregnation with the mixture; drying at room temperature to remove the solvent and washing with water. The obtained materials absorbed light up to 470 nm and had a thin-film coating of a binder with fixed particles of anatase-modified titanium dioxide. Also, photoactive coatings were applied to the surfaces of different materials such as fabric, glass, and metal.

Contaminant destruction was investigated under visible light (450 nm, 160 mW·cm<sup>-2</sup>). The acetone was completely oxidized to carbon dioxide and water. Additionally, DNA fragments were shown to be rapidly destroyed on the surface of such materials. An increase in the length of the fragment contributes to an increase in the efficiency of its destruction. Antiviral properties were investigated by titration in a two-layer agar method using the bacteriophage PA136 as an example. The virus was completely inactivated after 6 h of irradiation (Figure 1a). At the same time, a significant decrease in the amount of bacteriophage DNA was detected using polymerase chain reaction (Figure 1b), which confirmed the destruction of all virus structures. It is worth noting that copper enhanced the antiviral properties even without exposure to light.

The obtained results show the prospects of using these materials for permanent surface cleaning from various chemicals, macromolecules, and biological objects under visible light.

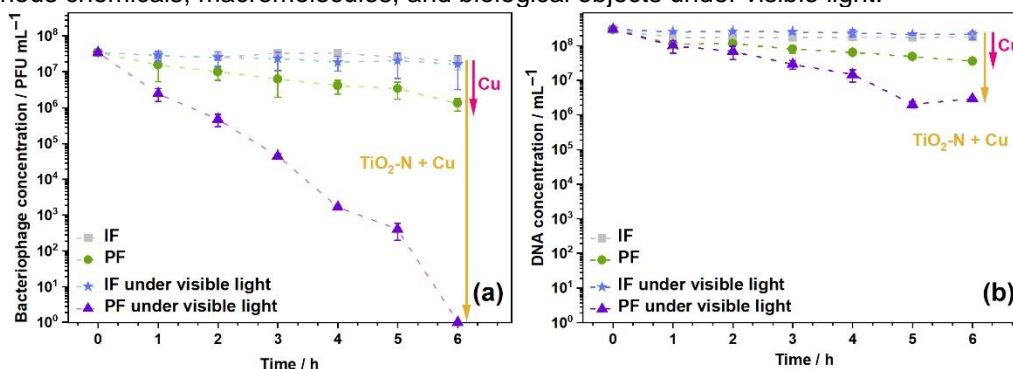

**Figure 1.** Inactivation of the bacteriophage PA136 (a) and its DNA concentration (b) over time

## References

- [1] *Chem. Eng. J.* **2020**, 388, 124167.
- [2] *Nanomaterials.* **2022**, 12, 3, 359.
- [3] *Catalysts.* **2022**, 12, 11.
- [4] *Patent of RF* №2793180. **2023**.

## Acknowledgements

This work was supported by the Ministry of Science and Higher Education of the Russian Federation within the governmental assignment for Borekov Institute of Catalysis (project FWUR-2024-0036) and the governmental assignment for Novosibirsk State University (№ 122122100147-9).

# NANOCOMPOSITES WITH CHARGE TRANSFER FOR RECOGNITION ORGANIC MOLECULES IN GAS PHASE BASED ON PHOTOCATALYSIS

*Skrypnik M.U., Platonov V.B., Vasiliev R.B.*

Moscow State University, Faculty of Chemistry, Moscow, Russia

1<sup>st</sup> year PhD Student

[skrypnikmy@my.msu.ru](mailto:skrypnikmy@my.msu.ru)

Recognition of organic molecules in the gas phase using compact and inexpensive devices is an important task in modern technologies. Living organisms solve this problem through biochemical reactions on olfactory receptors, providing unprecedented selectivity, which underlies odor recognition. In engineering, this task is addressed using semiconductor gas sensors based on metal oxides. However, the reaction of oxidation of organic molecules by chemisorbed oxygen, which is the basis of their operation, requires high temperatures and has low selectivity, fundamentally limiting the use of gas sensors. This study proposes a new concept for the operation of a gas sensor using photocatalysis on quantum dots (QDs) with photoexcited electrons transfer to the transport matrix of oxide semiconductor, resembling olfactory receptors.

In this work, hybrid nanocomposites based on CdSe QDs with organic ligands and nanodispersed powders of SnO<sub>2</sub> were studied. The photooxidation of aliphatic alcohols was chosen as a model reaction for photocatalysis. This is the reaction that does not require oxygen, oxidants, or heating, which are commonly used in the oxidation by chemisorbed oxygen in traditional gas sensors. CdSe QDs were synthesized using a colloidal method and the size of QDs was controlled with the time of the synthesis and optical spectroscopy. Native long-chain oleic acid ligands on the surface of CdSe QDs were exchanged for a series of short-chain molecules containing a thiol group for binding to the CdSe surface and a carboxyl group for binding to the metal oxide surface. The photocatalyst was obtained by immobilizing and chemically binding CdSe QDs on the surface of the ultra-dispersed metal oxide matrix. Photochemical reactions occurring on the system's surface were detected by monitoring the electrical resistance of the oxide matrix. The interaction of the photocatalyst surface with the gas phase was studied using methanol, ethanol, butanol-2, acetone, acetic acid, ethanal, methanal as examples. Device prototypes were fabricated by applying the photocatalyst to microelectronic chips to control electrical resistance. The photocatalytic reaction was provided under the yellow radiation with a wavelength of 595 nm. SnO<sub>2</sub> samples modified with QDs have lower baseline resistance than pure samples of SnO<sub>2</sub> due to electron transfer from QDs to the oxide matrix. An increased resistance amplitude is observed after introducing 100-1000 ppm of the analyzed organic molecule in gas phase compared to an inert atmosphere, attributed to the interaction of the photoexcited hole with alcohol molecules. Concentration dependence on different organic compounds ratios was also investigated. The sensor response dependency on the distance between QDs and the metal oxide matrix was studied by varying the length of the organic ligand chain, as well as evaluating the influence of ligand coordination (carboxylate and thiolate). The process of photooxidation of organic molecules by photocatalysts was established with a detailed analysis of photocatalysis products using FTIR, DRIFT, and NMR spectroscopy.

## References

- [1] *Science* **2014**, 343, 1370
- [2] *The Journal of Physical Chemistry Letters* **2021**, 12, 7180

## Acknowledgements

This work was supported by the Russian Science Foundation (project No 22-13-00101).

# DOUBLE SENSORS FOR MONITORING FREEZING AND SPOILAGE OF PRODUCTS BASED ON LATEX NANOPARTICLES AND CURCUMIN

*Statsenko T.G.<sup>1,2</sup>, Golubkov S.S.<sup>1</sup>, Koltsov S.I.<sup>1</sup>, Morozova S.M.<sup>1,3</sup>*

<sup>1</sup> Bauman Moscow State Technical University, Moscow, Russia

<sup>2</sup> Federal Research Center of Problems of Chemical Physics and Medicinal Chemistry, Russian Academy of Sciences, Chernogolovka, Russia

<sup>3</sup> Moscow Institute of Physics and Technology, Moscow, Russia

PhD Student

[tatianaststsenko@yandex.ru](mailto:tatianaststsenko@yandex.ru)

The quality of food is an important factor affecting public health. Food monitoring through active and intelligent packaging, with a focus on informing consumers about food quality, is expected to improve the effectiveness of foodborne disease control [1]. This research aims to develop an environmentally friendly and biocompatible sensor for food spoilage detection and monitoring of temperature storage to improve food safety. The sensor contains 90% water, the remaining components are latex particles based on biocompatible polyvinyl acetate, natural dye curcumin and NaCl.

Previously, we demonstrated that for the mixture of oppositely charged latexes the state of colloidal systems depends on the temperature (T) at which experiments were performed and glass transition temperature ( $T_g$ ) of the polymer [2]. At  $T < T_g$  latexes form colloidal gels with hard-hard contacts between particles, while at  $T > T_g$  they undergo phase separation with the formation of aggregates. In this work, we confirmed the presence of this effect for the colloidal systems based on positively charged latex and high ionic strength, i.e. changes in salt concentration. To study the formation of colloidal clusters and gels, we conducted an experiment using mixtures of positively charged polymer nanoparticles (NPs) based on polyvinyl acetate (p(VAc)+ NPs) and aqueous solutions of sodium chloride. Latex (p(VAc)+ NPs) were prepared by emulsion polymerization, the hydrodynamic radius of NPs  $R_h$  was 25 nm, and the electrokinetic potential  $\zeta$  potential was +25 mV.

The sensor was prepared by placing a colloidal system prepared at 0–3 °C based on 0.05 wt.% latex (p(VAc)+ NPs), 0.0028 M NaCl and 0.5 mg/ml curcumin into a dialysis bag. Cocktail shrimp were used to illustrate the sensor's operation (Scheme 1).

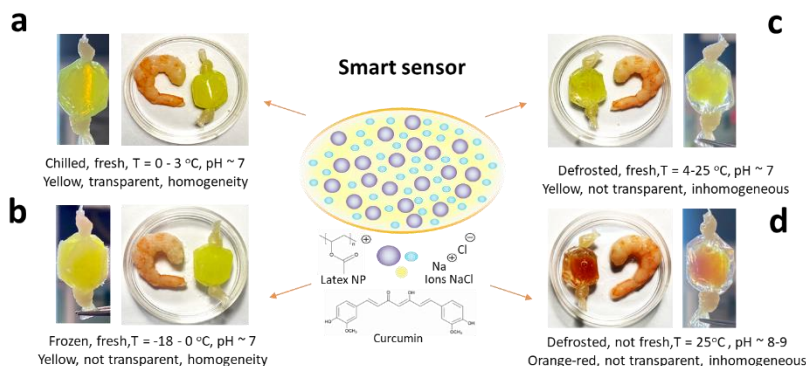

**Scheme 1.** Illustration of sensor operation at different temperatures and product freshness - (a-d) experimental sample type of sol at different temperatures and type of freshness of cocktail shrimps, system at 0-3 °C, fresh (a) frozen system at -18 °C, fresh (b), defrosted system 4-25 °C, fresh (c), defrosted system and kept at 25 °C for 8 hours (d); Petri dish size is 60 x 15 mm.

The developed sensor, based on the coagulation effect of colloidal latexes, provides an easy-to-use, cost-effective and efficient platform for the development of smart packaging. This platform allows the customer to control the transport and storage conditions of temperature-sensitive components, including food, drugs and biological reagents.

## References

- [1] *Food Packaging and Shelf Life*, **2024**, (Sent to the editorial office)
- [2] *ACS Nano*, **2023**, 17(15), 15012–15024

## Acknowledgements

This work was supported by the Russian Science Foundation (project No 21-79-20113).

# CHEMICAL POLISHING OF COPPER USING INVERSE MICROEMULSION CONTAINING NITRIC ACID

*Steshenko A.A.<sup>1</sup>, Murashova N.M.<sup>1</sup>*

<sup>1</sup> Mendeleev University of Chemical Technology of Russia, Moscow, Russia  
Postgraduate  
[steshenko.arsenii@gmail.com](mailto:steshenko.arsenii@gmail.com)

Microemulsions find a wide range of applications to solve problems in chemical technology. Inverse (water in oil) microemulsions containing an aqueous acid solution in droplets can be used for chemical polishing of metals [1]. Using chemical polishing, you can process products of complex shapes with areas that are difficult to reach for mechanical polishing. It is assumed that droplets of microemulsion with acid will primarily interact with protruding surface irregularities, which will result in flattening of the surface. The use of a microemulsion allows for more precise control of the process, since the metal dissolves more slowly in comparison with reaction in an aqueous solution of the etchant. Microemulsion polishing does not use complex equipment and induce less corrosion on it compared to conventional chemical polishing.

The range of suitable concentrations of nitric acid in the aqueous phase was selected based on data on its solubilization in various microemulsion compositions. A microemulsion in the system sodium dodecyl sulfate (SDS) – butanol-1 – kerosene – aqueous solution of HNO<sub>3</sub> is a multicomponent system, its properties depend on many factors simultaneously. Therefore, two types of multifactor experimental designs were used for this study. Screening design was used to determine the significance of the influence of microemulsion composition on two responses - solubilization capacity for nitric acid and microemulsion droplet size. The correlation between these two response parameters was also tested. Response surface design was used to infer a numerical dependence between microemulsion composition and maximum concentration of solubilized nitric acid. It was found that the size of microemulsion droplets does not directly correlate with the solubilization capacity for nitric acid, but it increases most strongly with a decrease in the ratio of butanol to SDS, as well as with a decrease in the mass fraction of water and an increase in the mass fraction of SDS in the microemulsion. The dependence surface has a saddle shape with an increase in maximum solubilization with a significant increase in the mass fraction of surfactants and cosurfactants and a decrease in the mass fraction of water. The electrical conductivity of the microemulsions ranged from 0.485 to 33.5 mS/cm; it increased with increasing content of the aqueous phase (0.5 mol/l HNO<sub>3</sub> solution) in the microemulsion from 9.5 to 35.9 wt.%. Based on the data obtained, a polishing composition with a possible content of nitric acid in the aqueous phase of 0.5–3.9 mol/l was selected.

The effect of the concentration of nitric acid in the microemulsion aqueous phase on the kinetics of copper chemical polishing was studied. Surface roughness analysis was carried out using a microinterferometer (MII-4) based on the arithmetic mean profile deviation Ra and the largest profile height difference Rz. Before measurements, the surface was cleaned of microemulsion components successively in acetone, an aqueous soda solution with a concentration of 20 g/l, and boiling water.

During the first minutes of polishing, the values of the Ra and Rz parameters change slightly. Then, both small and large surface protrusions dissolve, and a gradual decrease in both parameters is observed. After reaching a certain minimum in the curves of Ra and Rz versus time, the surface begins to be etched, which leads to an increase in Ra and Rz. At high concentrations, the roughness increases immediately, only etching occurs. Also, in addition to changes in the macrorelief, the dynamics of changes in surface texture (microrelief) were observed for nitric acid concentrations of 1.0-2.0 mol/l. At the beginning of polishing, single microdefects were observed, then only large rolling lines were visible on the surface, and at the end a uniform wavy texture was observed. The best polishing results were achieved at a concentration of 0.5 mol/l nitric acid in the aqueous phase of the microemulsion. The largest decrease in Ra 39.6% and Rz 27.3% was observed after 24 minutes of polishing. The reduction in roughness after polishing was confirmed by surface analysis using an optical profilometer (SuperView W1) and using atomic force microscopy (AFM). The AFM data are consistent with the microinterferometer results; the decrease was Ra 36.7% and Rz 18%. Analysis of the copper content in the microemulsion after the chemical polishing process confirmed that the copper plate dissolves and copper ions accumulate in the microemulsion.

Based on the data obtained, a new process for chemical polishing of copper using reverse microemulsions containing nitric acid will be developed.

## References

[1] *Protection of Metals and Physical Chemistry of Surfaces*, **2020**, 56, 309-316.



# SYNTHESIS OF NANOSTRUCTURED COPPER COMPOUNDS FOR ELECTROCATALYTIC UTILIZATION

*Streminskaya R.A.,<sup>1</sup> Krivoschapkin P.V.<sup>1</sup>*

<sup>1</sup> ITMO university, St. Petersburg,, Russia,

1st year Master Student

[streminskaya@scamt-itmo.ru](mailto:streminskaya@scamt-itmo.ru)

Nanoparticles exhibit a high surface area-to-volume ratio, making them more active and selective catalysts compared to bulk materials. This characteristic contributes to enhancing the efficiency of electrocatalysis and addressing issues related to energy barriers in reactions [1].

Three different catalyst materials were synthesized, each with distinct characteristics for CO<sub>2</sub> conversion. Initially, spherical copper(I) oxide nanoparticles were fabricated employing Ostwald ripening technology [2]. Subsequently, a catalyst featuring plate-like nanostructures was derived via electrochemical reduction of CuO using galvanostatic anodic oxidation [3]. Lastly, CuO plates with nanoscale defects were synthesized through the hydrothermal method in an alkaline solution [4].

For characterization purposes, the morphological and phase composition analyses of the particles were conducted employing scanning electron microscopy (SEM) as shown in Figure 1, accompanied by energy-dispersive analysis, and X-ray diffraction (XRD) techniques.

For testing of catalyst materials, particle dispersions were applied by impregnation method on copper and nickel foams and by drop-coating method on the carbon electrode and were tested in H-type cells with different volumes.

As result, Spherical copper(I) oxide structures showed the best performance with a faradaic efficiency of 63.96% for C<sub>2</sub>+ products.

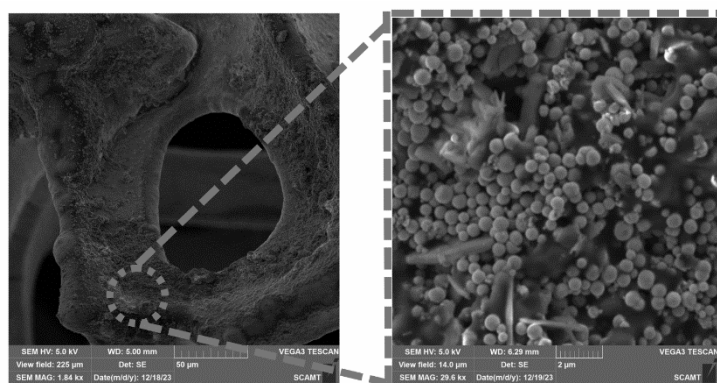

**Figure 1.** SEM image of nanoparticles deposited on nickel foam and SEM image of the surface morphology of hollow multilayer cloud-like structures of copper(I) oxide Cu<sub>2</sub>O

## References

- [1] Łosiewicz, B.; Popczyk, Magdalena, *Aims of Electrocatalysis. Solid State Phenomena*, **2015**, 228(), 179–186.
- [2] Chen, X.; Zhao, Y.; Han, J.; Bu, Y. Copper-Based Catalysts for Electrochemical Reduction of Carbon Dioxide to Ethylene. *ChemPlusChem* **2023**, 88 (1), e202200370.
- [3] Fan, M.; Huang, J. E.; Miao, R. K.; Mao, Y.; Ou, P.; Li, F.; Li, X.-Y.; Cao, Y.; Zhang, Z.; Zhang, J.; Yan, Y.; Ozden, A.; Ni, W.; Wang, Y.; Zhao, Y.; Chen, Z.; Khatir, B.; O'Brien, C. P.; Xu, Y.; Xiao, Y. C.; Waterhouse, G. I. N.; Golovin, K.; Wang, Z.; Sargent, E. H.; Sinton, D. Cationic-Group-Functionalized Electrocatalysts Enable Stable Acidic CO<sub>2</sub> Electrolysis. *Nat Catal* **2023**, 6 (9), 763–772.
- [4] Electrochemical CO<sub>2</sub> reduction to ethylene by ultrathin CuO nanoplate arrays | *Nature Communications*, **2024**.

## Acknowledgements

The work was carried out with the support of the state assignment No. FSER-2022-0002 within the framework of the national project "Science and Universities". INVESTIGATION OF THE POSSIBLE

## APPLICATION OF TECHNOGENIC SILICA GEL FOR HYDROTHERMAL SYNTHESIS OF LTA-TYPE ZEOLITES

*Svakhina Ya.A.<sup>1</sup>, Titova M.E.<sup>1</sup>, Pyagay I.N.<sup>1</sup>*

<sup>1</sup>Empress Catherine II St. Petersburg Mining University, St. Peterburg, Russia  
Junior researcher  
[y\\_svakhina@mail.ru](mailto:y_svakhina@mail.ru)

Nowadays, synthetic zeolites are widely used in many chemical industries due to their well-developed pore and channel system.

The zeolite framework, consisting of  $[\text{SiO}_4]^{4-}$  and  $[\text{AlO}_4]^{5-}$  tetrahedrons, has a negative charge, which is compensated by positively charged alkali or alkaline-earth metal ions. Due to the high mobility of positive metal ions, zeolites exhibit high efficiency in ion exchange processes. Thus, low-modulus zeolites are used as water treatment and water purification agents to reduce overall water hardness or remove heavy metal ions [1, 2]. In addition, the presence of molecular sieve properties in low-modulus LTA-type zeolites allows them to be used to produce zeolite membranes, which are widely used in pervaporation and vapour permeation processes for the separation of aqueous-organic mixtures [3, 4].

Continuously growing demand for zeolite materials associated with the increasing use of LTA-type zeolites as components of detergents and dehumidifiers raises the question of creating knowledge-intensive technology with the use of secondary resources. The use of anthropogenic wastes as raw materials will allow to expansion of the production of zeolites and reduce the load on the environment by utilization of wastes.

One of the promising silicon-containing resources for the production of LTA-type zeolites by hydrothermal synthesis is aluminium fluoride production waste - silica gel. Silica gel, which is a hydrated fine powder with a  $\text{SiO}_2$  content of more than 50 %, can be used to produce sodium silicate, a precursor of zeolites.

The authors of the work considered the process of LTA type zeolites production using technogenic silica gel containing more than 30 wt.% of aluminium fluoride impurities. Silica gel was subjected to sulphuric acid purification in order to obtain amorphous silica with  $\text{SiO}_2$  content not less than 90 wt.%, which was used to obtain the silicate component of aluminosilicate gel. The molar ratios of aluminosilicate gel components for zeolite synthesis and optimal parameters of the crystallization process were established in the course of the study.

Samples of LTA-type zeolites from aluminosilicate gel of a certain composition were obtained at a process temperature of at least 95 °C with a process duration of more than 1 hour. Based on the study of the phase composition and morphology of the obtained precipitates, the samples presented a phase of LTA type zeolite, the particles of which have a cubic shape, and the average particle diameter does not exceed 10  $\mu\text{m}$ .

Thus, the presented research results confirm the reliable possibility of obtaining LTA-type zeolites during the processing of technogenic waste-silica gel. In addition, the parameters of the crystallization process and molar ratios of aluminosilicate gel for synthesis were established experimentally. Characteristics of the obtained zeolites indicate their possibility for effective application in the processes of ion exchange and dehydration of organic mixtures.

### References

- [1] Koohsaryan E., Anbia M., Maghsoodlu M. Application of zeolites as non-phosphate detergent builders: A review. *J. Environ. Chem. Eng.* **2020**, 8(5), 104287.
- [2] Tran H.N., Viet P. Van, Chao H.P. Surfactant modified zeolite as amphiphilic and dual-electronic adsorbent for removal of cationic and oxyanionic metal ions and organic compounds. *Ecotoxicol. Environ. Saf.* **2018**, 147, 55–63.
- [3] Wu X. et al. Improved hydrothermal stability of LTA zeolite membrane by forming an acrylamide protective layer for pervaporation dehydration of water-rich acrylamide and ethanol solutions. *Microporous Mesoporous Mater.* **2024**, 365, 112888.
- [4] Wang L. et al. Sustainable fabrication of large-scale tubular LTA zeolite membranes by a simple wet gel conversion. *Microporous Mesoporous Mater.* **2022**, 329, 111541.

### Acknowledgements

The investigation was conducted at the Scientific Center "Issues of Mineral and Technogenic Resources Processing" with the involvement of the laboratory base of the Center for Collective Use of Empress Catherine II Saint Petersburg Mining University.

## HYBRID SYSTEMS BASED ON GOLD NANOPARTICLES, CHITOSAN AND PROTOPORPHYRIN AS AGENTS OF ANTIBACTERIAL PHOTODYNAMIC THERAPY

*Svinko V.O., Solovyeva E.V.*

St. Petersburg State University, St. Petersburg, Russia  
[st077077@student.spbu.ru](mailto:st077077@student.spbu.ru)

Antibacterial photodynamic therapy (APDT) is a method for treating complex cases of purulent infections and periodontal diseases that is rapidly gaining popularity. Modern APDT utilizes chlorin- and porphyrin-based photosensitizers. To enhance the effectiveness of APDT agents, hybrids of photoactive substances with gold nanoparticles are considered promising. Gold nanoparticles offer several advantages, such as the ability to significantly increase the amount of generated reactive oxygen species (ROS), excitation within the transparency range of biological tissues, low cytotoxicity and hematotoxicity, as well as relatively easy surface modification. Polyelectrolytes are often used for surface modification of nanoparticles to enhance their aggregative stability in complex environments with high salt concentrations. Natural amido polysaccharides, such as chitosan, which have high biocompatibility, are rational choices for coatings. However, there is still very limited data on the mutual influence of the individual components (photosensitizer, plasmonic particle, and biopolymer) on each other's properties in hybrid systems. Moreover, the effects observed depend on the nature of the individual components. This study is dedicated to establishing the influence of a gold core with a chitosan coating on the photophysical properties of protoporphyrin IX.

In the first stage of the work, nanostructures consisting of gold nanorods covered with a polymer shell, including polyacrylic acid and chitosan, were obtained. The incorporation of the photosensitizer was conducted via three different methods: using electrostatic adsorption, covalent conjugation allowing direct binding of protoporphyrin IX to the coated metallic core, and binding the photosensitizer to chitosan followed by coating the nanoparticle. For the obtained systems, the efficiency of the conjugation was evaluated using infrared spectroscopy, the optical properties were studied, and the generation of ROS by the obtained nanohybrids was assessed.

As a result of the work, ternary systems consisting of a metallic core coated with chitosan and protoporphyrin IX were successfully obtained. The resulting hybrids demonstrated high efficiency in generating ROS, which is currently a promising result.

### **Acknowledgements**

**The work was supported by Saint-Petersburg State University, project № 122040800256-8.** The authors would like to thank the Resource Centers of SPbU: "Optical and Laser Materials Research", "Chemical Analysis and Materials Research", "Physical Methods of Surface Investigation", "Center for Molecular and Cell Technologies", "Interdisciplinary Center for Nanotechnology", "Cryogenic Center".

# DEVELOPMENT OF A TECHNIQUE FOR DETERMINING THE ACTIVITY OF ARGININE DEIMINASE USING A VOLTAMMETRIC AMMONIA SENSOR BASED ON COPPER (II) SULFATE COATED WITH A POLYMER MEMBRANE

*Sychinskaia K.A.<sup>1</sup>, Ermakov S.S.<sup>1</sup>*

<sup>1</sup> St. Petersburg State University, St. Petersburg, Russia  
Student  
[st107302@student.spbu.ru](mailto:st107302@student.spbu.ru)

More than 40 years ago, the first suggestions appeared that various tumor cells are sensitive to a lack of arginine. In recent years, due to the increase in the number of oncological diseases, the need for the development of new antitumor drugs has increased. In connection with this demand, the Institute of Experimental Medicine has begun to develop streptococcal strains capable of suppressing the growth of certain types of cancerous tumors by cleavage of L-arginine [1], [2]. But to determine the most effective strain, an assessment of the activity of the enzyme arginine deiminase, which is the basis of this new therapy, is required. Therefore, we have developed a technique that allows for a comparative analysis of the activity of this enzyme in various strains in a short time.

Arginine deiminase (ADI) is an enzyme that breaks down arginine to citrulline with the release of ammonia [3], [4], [5]. The lack of nutrients in the tumor triggers an evolutionarily conserved eukaryotic process called macroautophagy (autophagy), in which organelles and bulk proteins are processed by lysosomal activity [2].

The method for determining the activity of arginine deiminase was based on the reaction of enzymatic deamination and subsequent detection of released ammonia using a voltammetric ammonia sensor based on copper (II) sulfate coated with a polymer membrane of the Nafion type. L-arginine acted directly as the substrate, the reaction product is citrulline (1:1). In the course of the work, the degrees of influence of the substrate, Todd-Hewitt broth (pure and in the presence of culture in it) on the analytical signal were determined.

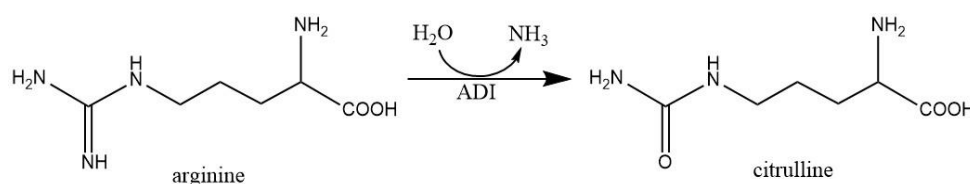

**Scheme 1.** The deamination reaction of arginine.

Since copper ions can form stable complexes with ammonia ( $\lg\beta_4 = 12.03$ ), voltammetric detection of the released ammonia is possible using a complexation reaction underlying the operation of a voltammetric ammonia sensor based on copper (II) sulfate. But the phosphate buffer, which ensures maximum bacterial activity at pH = 5-6 [5], and, accordingly, the enzyme arginine deiminase, does not allow the determination of small amounts of ammonia, since complexes are not formed at these pH levels. As a solution, a scheme was proposed according to which measurements are made first at the direct activity of bacteria, and then after stopping the reaction by adding concentrated NaOH (since at pH > 9 bacteria are not viable).

## References

- [1] D. Mossmann *et al.*, "Arginine reprograms metabolism in liver cancer via RBM39," *Cell*, vol. 186, no. 23, pp. 5068-5083.e23, Nov. 2023, doi: 10.1016/j.cell.2023.09.011.
- [2] R. H. Kim *et al.*, "Arginine deiminase as a novel therapy for prostate cancer induces autophagy and caspase-independent apoptosis," *Cancer Res*, vol. 69, no. 2, pp. 700–708, Jan. 2009, doi: 10.1158/0008-5472.CAN-08-3157.
- [3] G. Cottenceau, M. Dherbomez, B. Lubochinsky, and F. Letellier, "Immobilization and treatment of *Streptococcus faecalis* for the continuous conversion of arginine into citrulline," 1990.
- [4] H. Jiang, K. Huang, W. Mu, B. Jiang, and T. Zhang, "Characterization of a recombinant arginine deiminase from *Enterococcus faecalis* SK32.001 for L-citrulline production," *Process Biochemistry*, vol. 64, pp. 136–142, Jan. 2018, doi: 10.1016/j.procbio.2017.06.006.
- [5] I. Chibata and T. Tosa, "Transformations of Organic Compounds by Immobilized Microbial Cells," 1977.

## DIRECTED MODIFICATION OF HYDROXYAPATITE-BASED BIOCOMPATIBLE MATERIAL AS A WAY TO REGULATE ITS PROPERTIES

*Syukkalova E.A.<sup>1</sup>, Kolokolova N.D.<sup>1</sup>, Voskanyan L.A.<sup>1</sup>, Sadetskaya A.V.<sup>1</sup>, Osmolowsky M.G.<sup>1</sup>, Bobrysheva N.P.<sup>1</sup>, Voznesenskiy M.A.<sup>1</sup>, Osmolovskaya O.M.<sup>1</sup>*

<sup>1</sup>St. Petersburg State University, St. Petersburg, Russia  
Research engineer  
[evgenia.syukkalova@gmail.com](mailto:evgenia.syukkalova@gmail.com)

Nowadays synthetic analogs of natural materials are widely introduced in biotechnology, biomedicine, bone tissue engineering, and cosmetology. Recently, a great attention has been attracted to hydroxyapatite, as it is the main mineral component of the bone tissue of living organisms and can be obtained synthetically with scalable methods. Hydroxyapatite (HAp) is widely used in various fields of technology such as environmental remediation, biomedicine, gases detection, applications in catalysis and protein separation. However, in order to improve properties, the surface needs to be modified. Surfactants are typical and widespread agent used for HAp surface modification. In addition, PVA, casein sodium salt, lactic acid and other can be used as capping agents. The main problem of modification is the impact of capping agents of different nature on nanoparticles morphology as well as the position of the agent on nanoparticle surface are out of consideration.

Current work is dedicated to the synthesis of inorganic materials based on HAp NPs with different shape, size, and surface compositions and studying the impact of their morphological and structural parameters on the position of capping agent's molecules on surface. Salicylic, tartaric, succinic acids, pyrocatechol, 1,10-phenanthroline, and Nitroso-R salt were used as capping agents with a different ratio of hydrophilic / hydrophobic regions.

Two sets of HAp NPs samples were prepared. First set of HAp NPs were synthesized by hydrothermal procedure (2 h at 240 °C). Second set of HAp NPs with a modified surface were synthesized by chemical wet precipitation method at room temperature. Morphological parameters of all obtained samples were characterized by complex of physical and chemical methods: XRD, IR spectroscopy, TEM, SSA, and DLS. All resulting NPs had a rod-like shape and structure of hydroxyapatite. The dimensions of HAp NPs from first set were in the range of 23-26 nm (thickness) and 48-81 nm (length). For the second set – dimensions were in the range of 7-12 nm (thickness) and 18-32 nm (length).

The position of modifiers on the surface of HAp NPs was determined based on quantum chemical calculations using an original approach. It was shown that synthesis technique is impact to the position of modifiers on the surface of HAp NPs.

HAp NPs synthesized by hydrothermal procedure were used for dispersive micro-solid phase extraction of tetracyclines. It was shown that the coefficient of extraction of tetracyclines from a mixture by hydroxyapatite nanoparticles under optimal conditions can reach 98%. After determining the optimal conditions for sorption and elution processes, the efficiency of isolating and concentrating tetracyclines with sorbents based on modified hydroxyapatite nanoparticles under selected optimal conditions was demonstrated on real biological objects - human urine and animal feed.

HAp NPs synthesized by precipitation method were used as stabilizer of Pickering oil-in-water emulsions. In order to study emulsions stability, the following parameters were varied: oil:water ratio, pH of the medium, and mass of modified nanoparticles. It has been shown that the best inorganic component for stabilizing emulsions is a sample of hydroxyapatite nanoparticles modified with salicylic acid. The Pickering emulsion remained stable for more than 28 days after preparation. It was also found that with increasing mass of nanoparticles, the size of droplets of the oil phase decreases, while the size of the droplets increases with increasing oil:water ratio.

So, the directed modification can assist to produce HAp NPs for various application.

### **Acknowledgements**

The work was financially supported by the Russian Science Foundation (project no. 24-23-00225, <https://rscf.ru/en/project/24-23-00225/>).

The authors are grateful to the SPbSU Research Park, including resource centers «X-ray Diffraction Studies», «Chemical Analysis and Materials», «Nanotechnology», «Innovative Technologies of Composite Nanomaterials», «Optical and Laser Materials», «Diagnostics of Functional Materials», «Physical Methods of Surface Investigation», «Computing Centre», «Nanofabrication of Photoactive Materials (Nanophotonics)».

# MONITORING HYDROGEN PEROXIDE IN TUMOR METASTASIS: ACHIEVING TARGETED AND PERSISTENT LUMINESCENT SURVEILLANCE

Tao Jia<sup>1</sup>, Guanying Chen<sup>2</sup>

<sup>1</sup>St. Harbin Institute of Technology, China

<sup>2</sup> Harbin Institute of Technology, China

[chenguanying@hit.edu.cn](mailto:chenguanying@hit.edu.cn)

Tumor microenvironment is rich in hypoxia and reactive oxygen species (ROS), including substantial levels of hydrogen peroxide (H<sub>2</sub>O<sub>2</sub>) and reduced glutathione (GSH). Precise spatial and temporal early diagnosis within this complex environment is crucial for advancing cancer treatments. Near-infrared dye-sensitized upconversion nanoparticles (UCNPs) are designed as luminescent probes, with controlled reactivity to ROS through self-assembled monolayers on their surfaces. Coupled with a passive implanted system, a 20-day monitoring of H<sub>2</sub>O<sub>2</sub> in a rat model of ovarian cancer with peritoneal metastasis is conducted, overcoming challenges of limited light penetration depth and potential nano-probe toxicity. These novel monitoring strategies hold promise for accelerating the clinical application of nano-probes and biochemical detection techniques. [1-2].

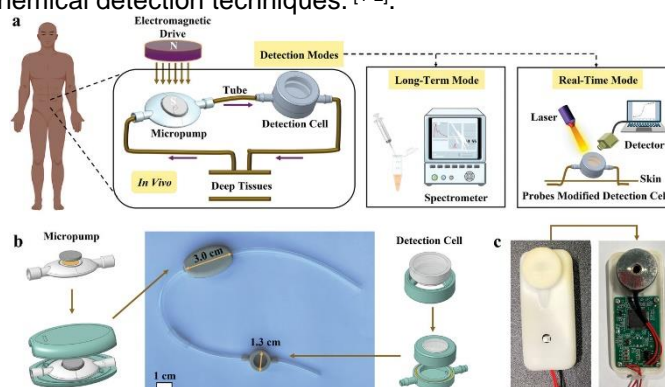

**Scheme 1.** Our developed detection modes and relevant devices for *in vivo* H<sub>2</sub>O<sub>2</sub> detection.

## References

- [1] *Nat. Rev. Drug. Discov.* **2013**, 12, 931.
- [2] *Andreescu, Curr. Opin. Electrochem.* **2021**, 29, 100809.

## Acknowledgements

This work was supported by the National Natural Science Foundation of China (52272270 and 51972084) and the Young Scientist Workshop (Harbin Institute of Technology) (AUGA9803502318).

## DISTINCTIVE FEATURES OF THE Fe<sub>3</sub>O<sub>4</sub>@ZnO CORE-SHELL NANOPARTICLE FORMATION, THEIR STRUCTURE AND PHOTOCATALYTIC ACTIVITY

*Tkachenko D.S.<sup>1</sup>, Meshina K.I.<sup>1</sup>, Zheltova V.V.<sup>1</sup>, Bobrysheva N.P.<sup>1</sup>, Osmolowsky M.G.<sup>1</sup>, Voznesenskiy M.A.<sup>1</sup>, Osmolovskaya O.M.<sup>1</sup>*

<sup>1</sup> St. Petersburg State University, St. Petersburg, Russia

Student

[dmitry.tka12@gmail.com](mailto:dmitry.tka12@gmail.com)

Currently, major cities worldwide are facing the problem of wastewater pollution by various organic contaminants. These include antibiotics and dyes, which enter water resources from light industry enterprises, livestock farms, medical facilities, and ordinary households. Current technologies do not allow for their complete elimination. Therefore, it is extremely important to find an effective and inexpensive method for treating wastewater contaminated with these pollutants.

One promising solution is the photocatalytic degradation of cyclic organic compounds under light irradiation in the presence of photocatalyst nanoparticles. However, the problem of separating water and nanoparticles in the form of powder is still present. This leads to the necessity of developing new materials that combine properties of a photocatalyst and an easily separated matrix.

Due to its non-toxicity, stability, and affordability, nano-sized ZnO is a promising candidate. On the other hand, Fe<sub>3</sub>O<sub>4</sub> nanoparticles exhibit superparamagnetic behaviour, which leads to the possibility of magnetic separation. Therefore, core-shell Fe<sub>3</sub>O<sub>4</sub>@ZnO nanoparticles would be a promising material for wastewater treatment.

However, shell formation leads to changes in the crystalline structure and, consequently, the properties of core-shell nanoparticles. Understanding this influence and how to predict it has defined the direction of this research.

Fe<sub>3</sub>O<sub>4</sub>@ZnO nanoparticles with different thicknesses and crystallinity degrees of the ZnO shell were obtained. Regulation of these parameters was achieved by an original approach based on varying the synthesis temperature and the sequence of reagent introduction. The obtained samples were characterized using a complex of physicochemical methods, namely, XRD, FTIR, HRTEM, AES-ICP, XPS, Raman spectroscopy, absorption and reflection spectra, vibrational magnetometry. In addition, magnetic property modelling using the Monte Carlo method were conducted.

The comprehensive analysis of all obtained data and modelled ZFC-FC curves has revealed that the shell influences the magnetic core by forming an intermediate layer. Its structure can be represented as a sequence of "magnetite—maghemite—goethite—zinc oxide," and the composition can be varied by changing the synthesis conditions. It has been established that it is the intermediate layer that determines the magnetic behaviour of Fe<sub>3</sub>O<sub>4</sub>@ZnO nanoparticles.

The most effective photocatalyst in the series exhibited a naphthol green B degradation efficiency of 77% after 60 minutes of irradiation with a UV lamp. Separation using an ordinary magnet showed the same result as that using a centrifuge. Thus, Fe<sub>3</sub>O<sub>4</sub>@ZnO nanoparticles work as a promising photocatalyst that can be easily separated using an inexpensive method.

### **Acknowledgements**

This work was supported by the Russian Science Foundation (project No. 23-23-00220). Scientific research was performed at the research park of St. Petersburg State University: Centre for X-ray Diffraction Studies, Centre for Innovative Technologies of Composite Nanomaterials, Chemical Analysis and Materials Research Centre, Centre for Physical Methods of Surface Investigation, Centre for Optical and Laser Materials Research, Interdisciplinary Resource Centre for Nanotechnology.

## SMALL NON-CODING 6S RNAS IN REGULATION OF SURFACTIN BIOSYNTHESIS IN BACILLUS SUBTILIS

*Trefilov V.S.*<sup>1</sup>, *Lindin E.Y.*<sup>1</sup>, *Burenina O.Y.*<sup>2</sup>, *Kubareva E.A.*<sup>3</sup>

<sup>1</sup>Lomonosov Moscow State University,  
Chemistry Department, Moscow, Russia

<sup>2</sup>Skolkovo Institute of Science and Technology, Moscow, Russia

<sup>3</sup>Lomonosov Moscow State University,

A. N. Belozersky Research Institute of Physico-Chemical Biology, Moscow, Russia

PhD student

[trefilov.vadik@gmail.com](mailto:trefilov.vadik@gmail.com)

6S RNA is a small non-coding RNA that has a conserved secondary structure similar to DNA in an open complex with RNA polymerase. It competes with DNA for binding to the enzyme and acts as a global transcription regulator in bacteria cells. It is known that *Bacillus subtilis* cells have two 6S RNAs, which are 6S-1 and 6S-2. The hypothesis that small non-coding RNAs affect and participate in the regulation of surfactin biosynthesis in *B. subtilis* can be made based on some scientific papers results.

Surfactin is a well-known and highly sought-after biological surfactant. Microbiological synthesis is the only way for producing significant amounts of surfactin. The knockout of the 6S-1 and 6S-2 genes in *B. subtilis* does not cause fatal consequences for the cell. Therefore, studying the role of 6S RNA in the metabolic pathway of surfactin could lead to the development of a new method for increasing the yield of surfactin formed by organisms.

The object of this research is *B. subtilis* NCIB 3610 which is natural strain of *B. subtilis*. It has been observed that deletion of the 6S-1 RNA gene leads to the increase of the level of mRNA for all the genes of *urfA* operon, which encodes four subunits of surfactin synthase, during the late stationary phase of growth. To evaluate the effectiveness of surfactin biosynthesis in bacterial cells, the spectrophotometric method based on the disruption of the complex between a pH indicator, bromothymol blue, and a cationic surfactant, cetylpyridinium chloride, when a surfactin solution is added to it, was optimized. We also used reversed-phase high-performance liquid chromatography (HPLC) to validate the results. Despite the increase in transcription levels of the surfactin synthase subunits genes, deletion of the 6S-1 RNA gene did not lead to increase of surfactin yield produced by *B. subtilis* NCIB 3610. To explain this result, we investigated the effect of 6S-1 RNA gene deletion on the transcription efficiency of genes that have an indirect influence on surfactin biosynthesis in *B. subtilis*. For instance, these genes encode synthetases of fatty acids and amino acids that are the parts of surfactin molecule, or synthetases of polyketides and exopolysaccharides that compete with surfactin synthetase for cellular resources. It has been observed that deletion of the 6S-1 RNA gene led to a significant increase in the expression of *rocG* and *glnA* genes. These genes are responsible for glutamine acid catabolism which is the first amino acid in the surfactin peptide fragment. So, a decrease in glutamine acid level inside the cell could negatively affect the yield of surfactin, leading to a lack of increased efficiency in mutant cells.

Similar studies are being conducted on 6S-2 RNA.

### Acknowledgements

This work was supported by the Russian Science Foundation (project No 24-24-00193).



# STUDY OF ADSORPTION PROPERTIES OF POLY[2-METHYL-1H-INDOLE] DERIVATIVES

*Usmanova G.S., Latypova L.R., Mustafin A.G*

Ufa Institute of Chemistry of the Russian Academy of Sciences, Ufa, Russia

Postgraduate student

[gulsum.dom@mail.ru](mailto:gulsum.dom@mail.ru)

Protection of water resources from pollution is the most important ecological task of our time. Adsorption occupies a special place among various methods of wastewater treatment from toxic components. However, the development of sorption technologies in solving environmental problems is constrained by the lack of available highly effective, easy-to-use sorbents.

The presented work presents the results of investigation of the possibility of obtaining new adsorption materials based on polyindole and their derivatives obtained in the process of modification of polyalkenylanilines (Scheme 1) [1, 2].

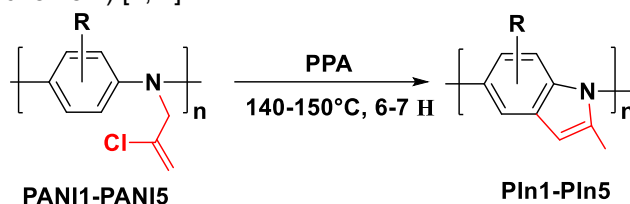

**Scheme 1.** Synthesis of polyindole derivatives.

The adsorption properties of polyindole derivatives (PI n1-PI n5) towards anionic dye methyl orange were investigated (Figure 1), and the influence of adsorbent amount, initial solution concentration, contact time and pH on the adsorption process was determined.

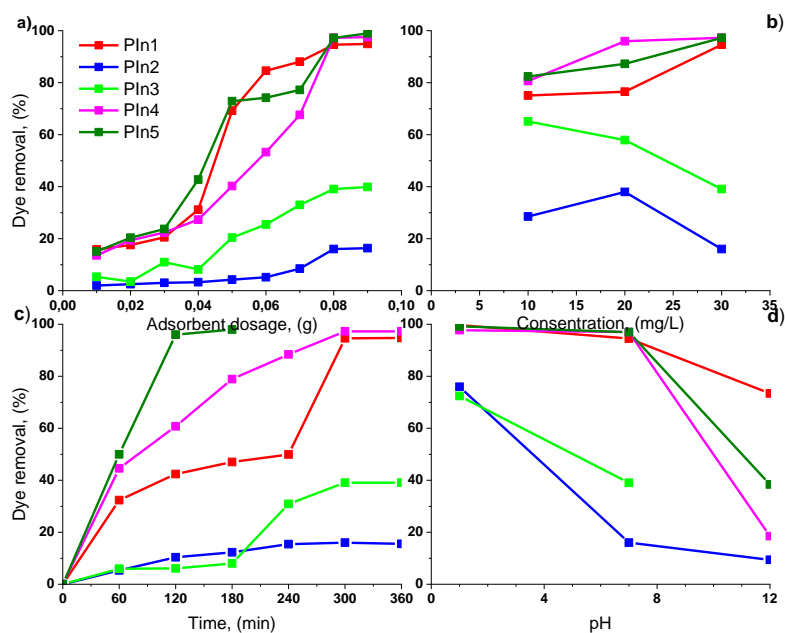

**Figure 1.** Influence of the adsorbent dose (a), initial concentration (b), contact time (c) and pH (d) on the adsorption process.

## References

- [1] *Polym. Chem.* **2021**, 12, 5650
- [2] *Chem. Pap.* **2022**, 77, 473

# SYNTHESIS AND STUDY OF MANGANESE-CONTAINING PHOTOCATALYSTS BASED ON $\text{Na}_2\text{La}_2\text{Ti}_3\text{O}_{10}$ LAYERED OXIDE

*Ustinova A.I.<sup>1</sup>, Voitovich V.V.<sup>1</sup>, Silyukov O.I.<sup>1</sup>*

<sup>1</sup>Saint Petersburg State University, St. Petersburg, Russia  
Student  
[st097834@student.spbu.ru](mailto:st097834@student.spbu.ru)

Photocatalytic decomposition of water and organic substrates under the action of sunlight is currently attract the attention of researchers due to the possibility of obtaining environmentally friendly hydrogen fuel. One of the well-known classes of heterogeneous photocatalysts is layered perovskite-like oxides in the structure of which there is a sequential alternation of two-dimensional blocks (layers) with a perovskite structure, with layers with a different type of structure (interlayer space). Some of them are capable of entering into ion exchange reactions (replacement of interlayer cations) and splitting into nanolayers. It is possible to introduce organic molecules into the interlayer space.

Three-layer perovskite-like titanate  $\text{Na}_2\text{La}_2\text{Ti}_3\text{O}_{10}$  belongs to the Ruddlesden-Popper phases [1]. It is known that this compound and corresponding protonated form  $\text{H}_2\text{La}_2\text{Ti}_3\text{O}_{10}$  exhibits photocatalytic activity under ultraviolet radiation [2] but are inactive under visible radiation. According to the literature, cation substitution in the structure of such photocatalysts can lead to light absorption in the visible region [3].

This work is devoted to the development of a procedure for the synthesis of layered perovskite-like titanates of the composition  $\text{Na}_2\text{La}_2\text{Mn}_x\text{Ti}_{3-x}\text{O}_{10}$  and its corresponding protonated forms with the degree of substitution of Ti for Mn in the range from 0.1 to 1.0, studies of the their structure, quantitative composition, light absorption region and photocatalytic activity of the protonated forms and nanolayers of these compounds in the reaction generation of hydrogen from an aqueous solution of methanol.

The compounds were synthesized by high-temperature solid state reaction. The optimal synthesis conditions were selected by varying the temperature, duration and number of calcination steps, and an excess of  $\text{Na}_2\text{CO}_3$ . Single-phase samples were obtained, which was confirmed by X-ray diffraction. It was found that the Mn-containing oxides are isostructural to the Mn-free compound, manganese is predominantly introduced into the central octahedron of the perovskite block. The data obtained by DRS indicate a decrease in the band gap and the appearance of light absorption in the visible region of the spectrum when manganese is introduced into the oxide structure. However, photocatalysts under ultraviolet, visible and simulated sunlight in aqueous solutions of 1% (mol.) methanol using Pt as a cocatalyst showed a decrease in the efficiency of photocatalysis when replacing titanium cations with manganese cations.

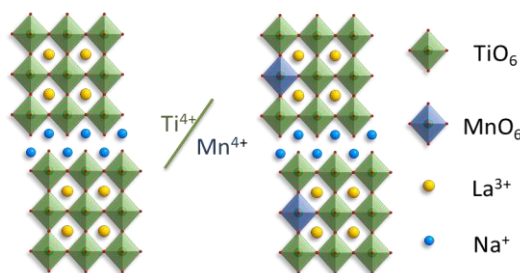

**Figure 1.** The schematic structure of  $\text{Na}_2\text{La}_2\text{Ti}_3\text{O}_{10}$  and  $\text{Na}_2\text{La}_2\text{Mn}_x\text{Ti}_{3-x}\text{O}_{10}$  compounds.

## References

- [1] *Ceramic Soc of Japan* **1994**, *102*, 737–741
- [2] *Russ J Gen Chem.* **2012**, *82*, 1191–1196
- [3] *Int J Hydrogen Energy* **2010**, *35*, 3306–3312

## Acknowledgements

The work was supported by Russian Science Foundation (grant №22-73-10110). Authors are also grateful to Saint Petersburg State University Research Park: Centre for X-ray Diffraction Studies, Centre for Optical and Laser Materials Research, Centre for Chemical Analysis and Materials Research, Centre for Thermal Analysis and Calorimetry, Centre for Nanotechnology.

# EFFECT OF SOLVENT AND CATALYST ON THE HYDROLYSIS RATE OF GERMANIUM ALKOXIDES – KEY STEP IN THE PRODUCTION OF GeO<sub>2</sub> AEROGELS

*Veselova V.O.<sup>1</sup>, Gajtko O.M.<sup>1</sup>*

<sup>1</sup> N.S. Kurnakov Institute of general and inorganic chemistry RAS, Moscow, Russia

Junior researcher

[ibvarvara@yandex.ru](mailto:ibvarvara@yandex.ru)

Spectral and kinetic characteristics of a luminescent material strongly depend on its morphology (particle size and agglomerate size), surface chemistry and deviations from stoichiometry. Oxygen-deficient GeO<sub>1.61</sub> aerogel exhibited strong blue luminescence at 425 nm ( $\lambda_{exc.} = 280$  nm), which is uncharacteristic for germanium oxide in a less dispersed state [1].

However, there are very few works dedicated to production of GeO<sub>2</sub> aerogels despite its similarity to SiO<sub>2</sub>. Previously GeO<sub>2</sub> aerogels were obtained by hydrolysis of tetraethoxygermanium in ethanol with HCl acting as a catalyst. Gelation time was 3 days and the resulting aerogels were extremely brittle and completely opaque. Choice of alkoxide precursor, solvent, gelation catalyst and its concentration might help control hydrolysis speed [2], but this research has never been done for germanium compounds.

In the present work the effect of various solvents and catalysts on the gelation speed of germanium alkoxides tetraethoxygermanium (TEOG) and tetraisopropoxygermanium (TiPOG) is studied. Ethanol, butylacetate, acetone, dimethylformamide and acetonitrile were tested as solvents. Only the use of acetonitrile allowed to obtain stable transparent gels and aerogels both using TEOG and TiPOG. The gelation time mainly depended on the water content in the system and was 3 h for TEOG:Acetonitrile:H<sub>2</sub>O:HCl ratio 1:50:8:0.001 and 1 min in case of 1:50:18:0.001. Concentration range of stable gel formation was determined for both of the germanium precursors and it was shown that TiPOG forms gels in a wider range of concentrations.

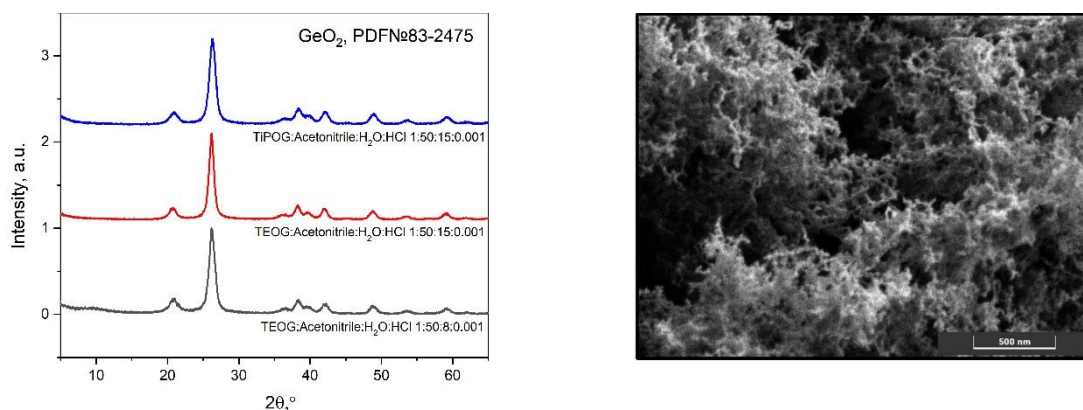

**Scheme 1.** X-ray diffraction patterns of GeO<sub>2</sub> aerogels obtained using TEOG and TiPOG as precursors, acetonitrile as solvent and HCl<sub>(aq)</sub> as gelation catalyst. SEM image of sample obtained using the ratio TEOG:Acetonitrile: H<sub>2</sub>O:HCl 1:50:15:0.001 (Red XRD line).

Multitude of gelation catalysts was tested: HCl, HF, HNO<sub>3</sub>, CH<sub>3</sub>COOH, NH<sub>3</sub>. Strong acidic catalysts resulted in stable gels, whereas weak acids and basic catalysts lead to precipitation of the sols. Obtained gels were dried in supercritical CO<sub>2</sub>. All the obtained aerogels were highly crystalline, had particle size of ~1-5 nm (Scheme 1) and specific surface area of ~50 m<sup>2</sup>/g.

## References

- [1] *Materials letters*. **2013**, 104, 41
- [2] *J.of materials science*. **1994**, 29,1807

## Acknowledgements

This work was supported by the Russian Science Foundation (project No 22-73-10182).

# INVESTIGATION OF THE PROPERTIES OF TETRAMETHYLENEDIETHYLENETETRAMINE FOR THE DEVELOPMENT OF AN ANTICORROSIVE COATING

*Vinogradova E.A.<sup>1</sup>, Molchanov V.P.<sup>1</sup>*

<sup>1</sup>Tver State Technical University, Tver, Russia

Student

[vinogradli27@yandex.ru](mailto:vinogradli27@yandex.ru)

Corrosion destroys metal structures and degrades their properties, causing economic and production losses, as well as a threat to safety. Therefore, the development of effective anticorrosive coatings is an important task in industry and construction. The use of new materials such as tetramethylenediethylenetetramine (TMDETA) in these coatings can improve their protective properties and durability.

Tetramethylenediethylenetetramine – 1,3,6,8-tetraazatricyclo [4.4.1.1<sup>3,8</sup>] dodecane belongs to the group of macrocyclic aminals that attract great attention due to their fundamental importance and widespread use in perfumery, veterinary medicine, construction and the oil and gas industry [1].

TMDETA is an organic compound, forming stable complexes with many metals and at the same time has a high adsorption capacity and chemical stability. It also has inhibitory properties and can form passive films on the metal surface that protect metal structures from oxidation and reduce the rate of corrosion reactions. In addition, TMDETA has good adhesion, which ensures durability, durability of the coating and increases the service life of objects. All these properties allow tetramethylenediethylenetetramine in the composition of anticorrosive coatings to interact effectively with the metal surface and prevent self-destruction of the metal.

The stability of TMDETA in solvents is an important parameter for the creation of coatings. To determine the solubility of tetramethylenediethylenetetramine, a quantitative analysis was performed using a gas chromatomass spectrometer PQ-2010s.

The results showed that TMDETA is better soluble in isopropyl alcohol and water. This is due to the fact that isopropyl alcohol, as a polar solvent, has a greater ability to form hydrogen bonds and interact with tetramethylenediethylenetetramine molecules. And in water it is of particular interest because, on the one hand, it has a rather high solubility, and on the other hand, the combined presence of hydrophilic and hydrophobic fragments in the molecule, which have a great influence on the surrounding water structure [2].

The study of publications and the results of economic research made it possible to systematize problems, analyze foreign products and trends in the development of the Russian market of specialized anticorrosive coatings [3]. And the main problem of the domestic market is the lack of high-quality coatings against corrosion of Russian production, which is covered by imports. The creation of coatings based on tetramethylenediethylenetetramine is an innovative solution for the construction chemicals market, which will help expand the range, attract customers from different industries, and stabilize demand within the country.

## References

- [1] Augusto R., Martín E., et al. NMR Study of Sequential Intermediates and Collateral Products in the Conversion of 1,3,6,8-tetraazatricyclo [4.4.1.1<sup>3,8</sup>] Dodecane (TATD) to 1,3,6,8-tetraazatricyclo [4.3.1.1<sup>3,8</sup>] Undecane (TATU) // Tetrahedron Letters. 2008. № 49, pp. 2154–2158
- [2] Evgeniy V. Ivanov., et.al. Some interaction-related thermodynamic properties of aqueous tetramethylenediethylenetetramine (drug teotropine) solutions: Effect of the solvent H/D isotope substitution and temperature // Journal of molecular liquids. 2021.V.326.
- [3] Pozdnyakov, E.S. Analysis of the financial condition of the enterprise on the example of UZS LLC / E.S. Pozdnyakov // Chelyabinsk: SUSU, 2021. 101 p.

## Acknowledgements

The study was carried out with the financial support of the Fund for Assistance to the Development of Small Enterprises in the Scientific and Technical Field (Agreement No. 19189GU/2023 dated March 12, 2024).

## OPTIMIZATION OF NANOSIZED CaF<sub>2</sub>:Eu SYNTHESIS VIA EXPERIMENTAL DESIGN

*Volik K.K.<sup>1</sup>, Kuznetsova P.D.<sup>1</sup>, Mukhanova E.A.<sup>1</sup>*

<sup>1</sup> Southern federal university, Rostov-on-Don, Russia

Student

[kvolik@sfedu.ru](mailto:kvolik@sfedu.ru)

X-ray luminophores can be used in X-ray photodynamic therapy for cancer treatment inside the human body. However, the optical properties and morphology of such substances strongly depend on the synthesis conditions. To control these properties, it is best to apply the design of experiments (DoE) together with microfluidic synthesis, as it allows many experiments under different conditions in a short time.

To perform such an experiment, we used the Dohlert scheme [1] (scheme 1). This allows us to obtain objective results with the smallest number of experiments.

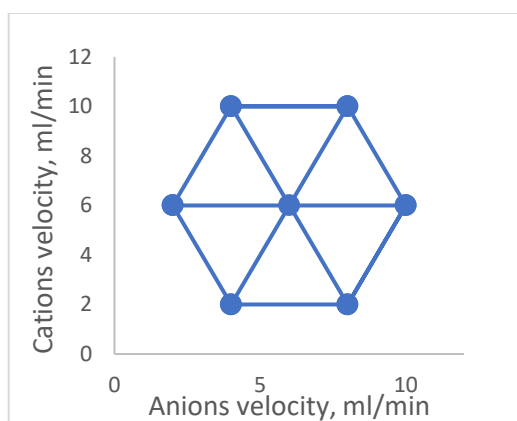

**Scheme 1.** Dohlert scheme.

Based on the experimental results, we constructed properties maps (scheme 2). Analyzing them, we came to the conclusion that the best conditions for synthesis are the speed of cations in the range 5-6 ml/min and the speed of anions in the range 7-8 ml/min.

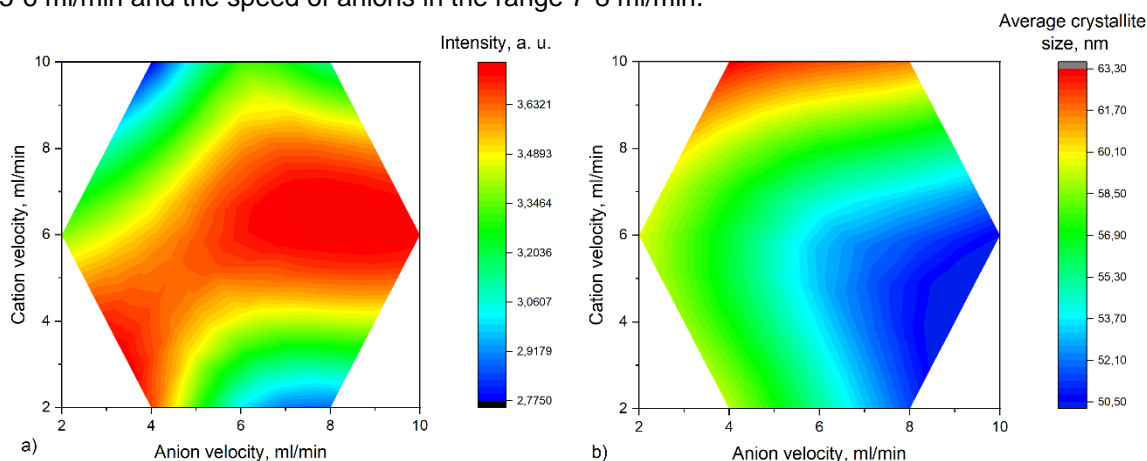

**Scheme 2.** Mapping schemes of microfluidic design: a) UV-Vis peaks intensity; b) Average crystalline size.

### References

[1] *Chem. Mater.* **2022**, 34(22), 9823-9835.

### Acknowledgements

The research was supported by the Strategic Academic Leadership Program of the Southern Federal University ("Priority 2030").

## SYNTHETIC APPROACHES TO OBTAIN A GREEN PALETTE OF MULTIFUNCTIONAL PIGMENTS BASED ON CHROMIUM-DOPED HYDROXYAPATITE NANOPARTICLES

*Voskanyan L.A., Morokhovets M.A., Tkachenko D.S., Bobrysheva N.P., Osmolowsky M.G., Voznesenskiy, M.A., Osmolovskaya O.M.*

St. Petersburg State University, St. Petersburg, Russia  
Student, first-year master's degree  
[vosk\\_lys@mail.ru](mailto:vosk_lys@mail.ru)

One of the main trends of the 21st century is to pay special attention to the quality of cosmetic products and their compositions. In terms of material science, the challenge is to develop effective and safe materials for the beauty industry.

Hydroxyapatite is the main component of human bone tissue, which determines the wide use of its synthetic analogue in various fields of medicine and biotechnology, as well as in the cosmetic industry. Hydroxyapatite has an anti-aging effect due to stimulation of collagen formation, and doping, in addition to color change, leads to pronounced UV reflection, which gives the proposed nanomaterial a third functionality - protection from UV radiation. In addition, hydroxyapatite is cheap to obtain, the method of production is scalable, and the final product is biocompatible and non-toxic.

The natural color of hydroxyapatite is white. Introduction of 3d-element ions into the structure of hydroxyapatite will allow to obtain an ecological pigment palette, and varying the conditions of synthesis will regulate not only the color, but also its intensity.

In the development of cosmetic products, green pigment, which is complementary to red pigment, is in great demand, which explains its ability to cover imperfections and inflammation on the face. Therefore, in this work, hydroxyapatite was doped with Cr<sup>3+</sup> ions.

It is known that the functional properties of a nanomaterial are often determined by the parameters of the nanoparticles themselves. An important but not fully understood issue for hydroxyapatite nanoparticles is the regulation of their size and shape.

The main method of hydroxyapatite production is 'wet' chemistry, which has a large set of ways to regulate the morphological parameters of nanoparticles: pH of the reaction medium, temperature, duration of synthesis, concentration of dissolved substances. In addition, it is possible to direct the formation of final nanoparticles by one of two mechanisms: Ostwald ripening or oriented attachment, which also allow to set the morphology of the final product.

Orientated attachment is a process where in the reaction medium under the influence of external conditions initiates the fusion of smaller primary nanoparticles with the formation of larger (final nanoparticles). The peculiarity of oriented attachment is that it is poorly studied and there is practically no information about the factors initiating it.

Therefore, within the framework of this work nanoparticles of hydroxyapatite doped with chromium were obtained by co-precipitation method, which consists in mixing of initial reagents at room temperature and separation of the final product in the form of a sparingly soluble substance. In order to obtain hydroxyapatite nanoparticles with different morphological parameters, the synthesis was carried out with incubation of the reaction medium at room temperature and at 100°C, and the reaction mixture was supplemented with regulating ions (K<sup>+</sup>, Na<sup>+</sup>).

The obtained samples of doped hydroxyapatite were characterized by a complex of methods: XRD (determination of the phase composition of the product, lattice parameters and crystallite sizes), IR spectroscopy (identification of the surface composition), BET (calculation of specific surface area and pore size), TEM (determination of the shape and size of the obtained particles), WPPM (clarification of crystallite sizes), XPS (analysis of the elemental composition of the substance, determination of the dopant oxidation degree), ISP-OES (determination of the qualitative and quantitative elemental composition of the sample).

The color of all samples was measured using a portable colorimeter and then expressed in the device-independent CIELAB color space.

### **Acknowledgements**

This work was supported by the Russian Science Foundation (project No 24-23-00225).

The authors are grateful to the SPbSU Research Park, including resource centers «X-ray Diffraction Studies», «Chemical Analysis and Materials», «Nanotechnology», «Innovative Technologies of Composite Nanomaterials», «Optical and Laser Materials», «Diagnostics of Functional Materials», «Physical Methods of Surface Investigation», «Culture Collection of Microorganisms», «Computing Centre».

## CONSTRUCTION OF HOLLOW ARTIFICIAL TISSUES BASED ON MAGNETIC ARCHIMEDES EFFECT

*Wan Zhao<sup>1</sup>, Xiaojun Han<sup>1</sup>*

<sup>1</sup>Harbin Institute of Technology, Harbin, China

Graduate student

[hanxiaojun@hit.edu.cn](mailto:hanxiaojun@hit.edu.cn)

Artificial tissues have structures and functions similar to those of natural tissues and are composed of one or more types of cells. They hold a wide range of biomedical applications as an in vitro model, to mimic the dynamic development of natural tissues, screen drugs for specific diseases, alleviate ethical issues in animal experiments, study cell-cell interactions, and be used for tissue transplantation. Tissues such as glomeruli, alveoli, and mammary glands in living organisms have a cavity structure. Although a variety of methods for constructing artificial tissues in vitro have been developed in recent decades, the lack of methods for constructing artificial tissues with cavity structures makes it challenging to study the aforementioned cavity tissues in vitro. Herein, we investigated the construction of various arrays of tissues with cavity structures using giant unilamellar vesicles (GUVs) and demonstrated the feasibility of constructing artificial tissues with cavity structures based on the magnetic Archimedes effect.

### **Acknowledgements**

This work was supported by the National Natural Science Foundation of China (Nos. 22174031).

# SYNTHESIS OF UV-CURABLE DISULFIDE FUNCTIONALIZED POLYSILOXANE FOR STRETCHABLE GOLD ELECTRODES WITH MICROCRACK

Wei Zhang<sup>1</sup>, Yongping Bai<sup>1, 2</sup>, Zhen Yang<sup>1</sup>, Ruolin Wang<sup>1</sup>, Linghui Meng<sup>1</sup>, Yu Wang<sup>1</sup>

<sup>1</sup> Harbin Institute of Technology, Harbin, China

<sup>2</sup> Wuxi HIT New Material Research Institute Co., Ltd., China

Student

[18545403079@163.com](mailto:18545403079@163.com)

Stretchable electrodes prepared by conductive layer and elastomer were widely applied in sensors, flexible electronic devices and health detections [1]. The microcracks in conductive layer strained synergistically with the elastomer, achieving linearly changing of conductivity with stretch. However, the interactions between the metal conductive layers and the substrates need to be enhanced for synergistical strain [2], [3]. In addition, the preparation of stretchable electrode with both high gauge factor (GF) and high stretchable conductivity is still a challenge [4-6]. The study reported the synthesis of lipoic acid functionalized polysiloxane elastomer (LFPSE), which adhered gold nanoparticles to prepare stretchable electrodes. Elastomer were cured through thiol-ene click polymerization and stretchable electrode was prepared through evaporating gold nanoparticles on LFPSE in vacuum. S-Au bond was characterized by Raman spectroscopy and XRD. Tensile conductivity was performed through microcrack propagation of Au. The study of UV curable polysiloxane elastomer based on thiol-ene with S-Au interaction provided a potential application in wearable flexible electronic devices and stretchable electrodes.

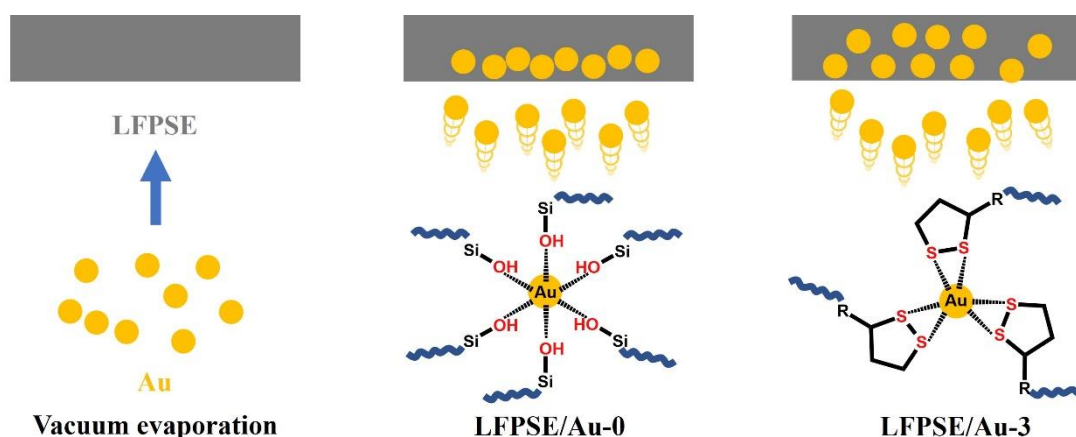

**Scheme 1.** Schematic diagram of gold nanoparticles adhering to the surface of UV-cured polysiloxane.

## References

- [1] Nano Energy 2019, 62, 674-681.
- [2] ACS Applied Nano Materials 2021, 4, 10845-10851.
- [3] ACS Nano 2021, 15, 19629-19639.
- [4] Composites Part A: Applied Science and Manufacturing 2020, 130, 105762.
- [5] Advanced Materials 2020, 32, 2000969.
- [6] ACS Sensors 2023, 8, 465-481.

## Acknowledgements

This work was supported by the special silicone joint laboratory established by Jiangxi Bluestar Xinghuo Silicone Co., Ltd. and Harbin Institute of Technology Wuxi New Materials Research Institute.



## CONSTRUCTION OF ARTIFICIAL PHOTOSYNTHETIC ORGANELLES

*Weichen Wang<sup>1</sup>, Xiaojun Han<sup>1</sup>*

<sup>1</sup>Harbin Institute of Technology, Harbin, China

Graduate student

[1103104304@qq.com](mailto:1103104304@qq.com)

The construction of artificial cells capable of mimicry of cellular structure and functions using a bottom-up strategy helps understanding the working mechanism of cells. Artificial photosynthetic cells can simulate photosynthesis to product ATP. However, it is challenging to achieve efficient energy supply and substance synthesis through a bottom-up approach. Here, we report the design of a bottom-up efficient energy-supplying artificial photosynthetic cell in chloroplast photosynthesis. ATP synthase and PSII were reconstituted on the phospholipid membrane as photosynthetic energy organelles, which integrated phycocyanin to enhance energy transfer efficiency. The production of ATP increase by 2.5-fold. The artificial photosynthetic organelles pave the path to build artificial cells with more complex metabolic networks.

# PARYLENE-N THIN FILM ENCAPSULATION FOR ENHANCED PEROVSKITE SOLAR CELLS STABILITY

Zagorovskaia K. D.<sup>1,2</sup>, Boldyreva A. G.<sup>2</sup>, Trepalin O. R.<sup>1,2</sup>, Krasnikov D. V.<sup>2</sup>

<sup>1</sup> Dmitry Mendeleev University of Chemical Technology of Russia, Moscow, Russia

<sup>2</sup> Skoltech, Moscow, Russia

Student

[Kseniia.Zagorovskaia@skoltech.ru](mailto:Kseniia.Zagorovskaia@skoltech.ru)

Perovskite solar cells (PSCs) have been a rapidly developing photovoltaic (PV) technology in recent years; for 14 years, they have achieved power conversion efficiencies above 26% [1], which is a record value among all emerging PV and even thin-film PV<sup>1</sup>. PSCs can be considered promising candidates for next-generation thin-film solar cells due to their outstanding electronic properties, chip and simple fabrication process. However, poor long-term stability of PSCs in ambient atmosphere, caused by bad perovskite extrinsic stability [2-4], limits the widespread use of PSCs as commercially implemented devices. It is crucial to find a good encapsulation strategy to overcome this obstacle. Encapsulation should protect PSCs from such destructive environmental factors as oxygen and moisture, and it should also prevent the evaporation of volatile degradation products.

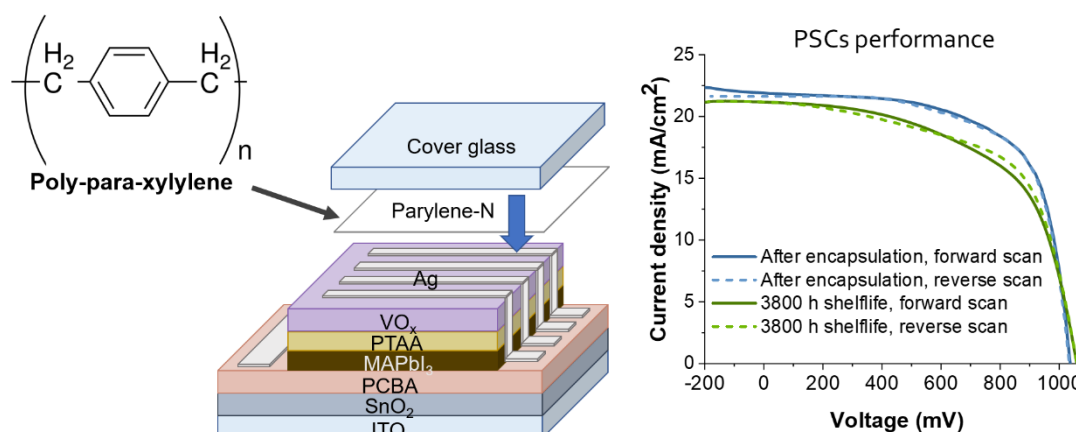

**Figure 1.** Parylene-N formula, scheme of PSCs architecture, PSCs performance before and after 3350 h shelflife in a dark ambient atmosphere.

In this study, we investigated parylene-N film as an encapsulation material for PSCs based on MAPbI<sub>3</sub> perovskite. Parylene-N film was deposited on the surface of devices with configuration by the chemical vapor deposition technique. We studied the thermal stability of MAPbI<sub>3</sub> films coated with parylene-N film on a hotplate at 85 °C, the extrinsic stability of encapsulated PSCs in a dark ambient atmosphere, and their thermal stability on a hotplate at 85 °C.

We have achieved minimal perovskite degradation and minimal loss of absorbance of parylene-coated perovskite films after 246 hours of heating at 85 °C. PSCs based on MAPbI<sub>3</sub> perovskite remained operational even after 29 hours at 85 °C due to encapsulation with parylene-N film.

Solar cells, encapsulated with parylene-N and cover glass, showed stable characteristics for over 3800 h in a dark ambient atmosphere. They retained almost 100% of their initial power conversion efficiency. There is only a slight degradation in J-V curves after the experiments (Fig. 1), which confirms the success of parylene-N in the dark ambient atmosphere stability test.

Based on the results of our study, we can assume that the use of parylene-N as an encapsulation material can increase the operation lifetime of PSCs in ambient conditions.

## References

- [1] Best Research-Cell Efficiency Chart. <https://www.nrel.gov/pv/cell-efficiency.html>
- [2] *J. Mater. Chem. A*. **2018**, 6, 9604
- [3] *J. Am. Chem. Soc.* **2015**, 137, 1530
- [4] *Adv. Energy Mater.* **2016**, 6, 1600014

## Acknowledgements

This work was supported by the Russian Science Foundation (project No 24-72-00085).

# OPTIMIZATION OF ZEOLITE LTA SYNTHESIS FROM KAOLIN VIA RESPONSE SURFACE METHODOLOGY

*Zdretsov I.M.<sup>1</sup>, Gerasimov A.M.<sup>1</sup>*

<sup>1</sup> St. Petersburg Mining University, Department of Chemical Technology and Energy Processing, St. Petersburg, Russia  
Graduate student, master of engineering  
[iv.zdretsov@yandex.ru](mailto:iv.zdretsov@yandex.ru)

Conventionally, zeolite LTA is a detergent builder, gas separator, and ion-exchanger for water purification. However, it has found novel applications as host for releasing anticancer drugs, luminescent-based humidity sensor, and hybrid photovoltaic solar cell [1, 2].

Zeolites are synthesized by hydrothermal method from pure sources of SiO<sub>2</sub> and Al<sub>2</sub>O<sub>3</sub>, whose production is relatively expensive and associated with waste generation. Here, we use kaolin as a low-cost alternative natural raw material for zeolite NaA (LTA) synthesis. The work aims to determine the conditions for obtaining the product with a relative crystallinity of more than 90 %.

Metakaolin obtained by cosmetic kaolin calcination at 750 °C for 1 h, was taken for synthesis. It was mixed with NaOH and H<sub>2</sub>O to prepare a reaction mixture with the formula 2,1SiO<sub>2</sub> : 1Al<sub>2</sub>O<sub>3</sub> : xNa<sub>2</sub>O : 100H<sub>2</sub>O, homogenized for half an hour at 400 rpm, and left for hydrothermal crystallization. Optimization of synthesis conditions has been performed using the response surface methodology (Box-Behnken design). Temperature and time, stirring speed, and Na<sub>2</sub>O : Al<sub>2</sub>O<sub>3</sub> were varied in the experiments. The responses were relative crystallinity and yield of the zeolite NaA, product water capacity, average NaA agglomerates and cubes size, and average number of cubes in the agglomerate. Product properties have been derived from X-ray diffraction (XRD), scanning electron microscopy (SEM), laser diffraction analysis (LDA), classical chemical analysis, and material balance.

As a result, we have obtained models for all responses. Figure 1 shows the response surfaces for relative crystallinity ( $R^2 = 0.6794$ , adj.  $R^2 = 0.6025$ , pred.  $R^2 = 0.4184$ ). The model for the average cube size has the best statistical values ( $R^2 = 0.9961$ , adj.  $R^2 = 0.9926$ , pred.  $R^2 = 0.9039$ ). The synthesis conditions for obtaining NaA with a relative crystallinity of 92.59 % are as follows: temperature of 80 °C, time of 5.95 h, stirring speed of 400 rpm, and Na<sub>2</sub>O : Al<sub>2</sub>O<sub>3</sub> = 3.

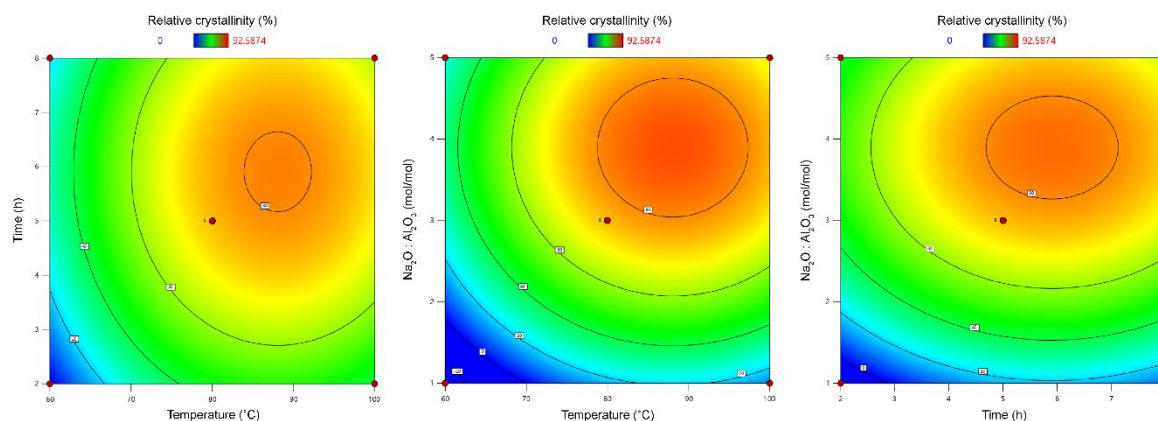

**Figure 1.** Derived response surfaces for relative crystallinity. Factors not shown on the axes have central values: 80 °C, 5 h, 200 rpm (no effect on relative crystallinity), and Na<sub>2</sub>O : Al<sub>2</sub>O<sub>3</sub> = 3.

The derived models are statistically satisfying, yet the product properties prediction without introducing additional constraints is difficult. Promising research is the synthesis of zeolite NaA from pre-formed metakaolin granules and kaolin purification technologies modernization to obtain pure zeolite for advanced applications.

## References

- [1] *Microporous Mesoporous Mater.* **2014**, *189*, 11
- [2] *Aerospace Research in Bulgaria.* **2020**, *32*, 209

## Acknowledgements

The authors are grateful to the Scientific Center "Issues of Processing of Mineral and Technogenic Resources" for the instrumentation and laboratory facilities provided for this study.

## ALUMINA AND ZIRCONIA AS NANOCONTAINERS FOR REPELLENT DELIVERY AND PROTECTIVE CLOTHING DEVELOPMENT

*Zverev S.A.<sup>1</sup>, Selivanova A.A.<sup>2</sup>, Zvereva A.S.<sup>1</sup>, Vinogradova Ya. V.<sup>2</sup>*

<sup>1</sup>Disinfectology Institute of F.F. Erisman FSCH of Rospotrebnadzor, Moscow, Russia

<sup>2</sup>MIREA – Russian Technological University (M.V. Lomonosov Institute of Fine Chemical Technologies), Moscow, Russia

Junior researcher

[zverev.s.chem01@gmail.com](mailto:zverev.s.chem01@gmail.com)

Nanomaterials are widely used for the delivery of components to hard-to-reach places. Such materials are widely used in biology, medicine, agriculture, and industry [1]. Not only their size, but also their versatility makes them special. Thus, the nanocapsulation approach can be used for the delivery of active ingredients by controlling their release at the desired site or target point.

Materials that can be used in a variety of ways are particularly important. Nanoporous aluminum and zirconium oxides with titanium dioxide are photocatalytic [2]. They can also act as sorbents. By combining such properties, nanomaterials can both expand the range of applications for such substances and increase the efficiency of their targeted application.

Health care may also benefit from nanomaterial approaches. To prevent the spread of dangerous parasitic diseases, DEET repellent is especially important. However, it is currently only used in cream and liquid form. Another essential tool for the protection of people is protective clothing [3]. However, it is more aimed at the protection of people from arthropod bites and is not always widely used by the population.

Therefore, the aim of the present study was to obtain textile materials with repellent properties, where nanoporous alumina and zirconia will be used as repellent carrier.

In the present study, we prepared nanoporous aluminum and zirconium oxides using a glycol-citrate synthesis method and studied their sorption properties towards the repellent N,N-diethyl-m-toluamide (DEET). The results showed that the oxides have sorption capacity to DEET (118 mg/g and 63 mg/g for aluminum and zirconium oxides, respectively) and can be used for transport to the target site.

In the subsequent phase, the oxides were combined with a solution of polyacrylate (alkyl substituted organic acid copolymer) fixative, which is employed in the production of finished textile products. The analysis of the resulting solution indicated that the repellent desorbed into the polymer solution, thereby enabling the solution to be further utilized for the application to fabrics. A variety of textile materials with varying DEET content (up to 150 mg/m<sup>2</sup>) were produced by immersing a 5x5 cm piece of fabric in a solution for a period of five minutes, followed by drying at 170°C for a further five minutes.

The results obtained indicate that aluminum and zirconium oxides can serve as nanocontainers for the delivery of substances, in particular repellents to various objects, such as on fabrics. Due to their sorption properties, these compounds overcame the difficulties in obtaining textiles with repellent properties because DEET has low solubility in water. This approach will produce materials that can be widely used by the public, thereby improving epidemiological protection and reducing the risks associated with the spread of dangerous infections.

### References

- [1] Zehra, S., Mobin, M., & Aslam, R. (2023). Nanocontainers: A comprehensive review on their application in the stimuli-responsive smart functional coatings. *Progress in Organic Coatings*, 176, 107389.
- [2] Istomina, L. I., Sakharov, K. A., Vikulina, E. I., Yan, Y., Solovov, R. D., Zverev, S. A., ... & Andreev, S. V. (2024). A novel approach to making composite photocatalyst by peroxide sol-gel deposition of TiO<sub>2</sub> on Al<sub>2</sub>O<sub>3</sub> and ZrO<sub>2</sub> nanosheets. *Brazilian Journal of Chemical Engineering*, 1-14.
- [3] Zverev, S. A., Andreev, S. V., Sakharov, K. A., Akhmetshina, M. B., Istomina, L. I., Verzhutskaya, Y. A., & Shashina, N. I. (2023). Evaluation of the efficacy of permethrin-and cypermethrin-based textile against taiga tick, *Ixodes persulcatus*. *Experimental and Applied Acarology*, 89(2), 275-286.



# **ABSENTEE PARTICIPANTS**

## SULFURIC ACID ACTIVATION OF KAOLIN CLAYS CHOVDARDAG FIELD OF AZERBAIJAN

*Abbasova G.M.<sup>1</sup>, Efendieva S.G.<sup>1</sup>, Nadirov P.A.<sup>2</sup>, Jafarova S.T.<sup>1</sup>, Gahramanova E.B.<sup>1</sup>*

<sup>1</sup>Ministry of Science and Education of the Republic of Azerbaijan Institute of Catalysis and Inorganic Chemistry named after Academician M. Nagiyev, Baku, Azerbaijan

<sup>2</sup> Azerbaijan State University of Oil and Industry, Baku, Azerbaijan

Junior researcher<sup>1</sup>, PhD

[gkanzayeva@mail.ru](mailto:gkanzayeva@mail.ru)

The search for new alternative sources of raw materials used in the metallurgical industry for the production of aluminum oxide against the backdrop of decreasing reserves of high-quality aluminum-containing raw materials makes research in this area very relevant. Therefore, the processing of high-silica aluminum-containing ores for the production of aluminum and its compounds is considered feasible. From this point of view, the use of local aluminosilicate raw materials, reserves of which in our republic reach tens of millions of tons, is of great importance. Until now, it has not been possible to process huge reserves of this raw material due to the lack of processing technology that would produce alumina of metallurgical quality. Experiments were carried out with aluminum-containing ores of the Chovdardag deposit in Azerbaijan, which were studied in their original and also in pre-calcined form. The results of X-ray phase analysis showed that the main minerals included in the clay consist of kaolinite ( $\text{Al}_2\text{Si}_2\text{O}_5(\text{OH})_4$  – 65 %), quartz ( $\text{SiO}_2$  – 31 %) and aluminum sulfate  $\text{Al}_2(\text{SO}_4)_3$  – 2 %). Currently, the most common method for producing aluminum oxide is the Bayer method. However, this method is used for ores with low silicon content (less than 5 %). In works [1-4], the decomposition of kaolin clays with sulfuric acid was studied. Studies were carried out on the dependence of the degree of extraction of aluminum and iron oxides from the composition of burnt rocks on temperature, process duration and sulfuric acid concentration. Leaching operations were carried out in a thermostated reactor—a jacketed vessel with a capacity of 0.20 L, equipped with a stirrer and a reflux condenser.

The weight of the sample in the experiments was 5 g. The original clay was crushed in a laboratory ball mill to a particle size of 0.1 mm, then fired in the temperature range 400-700 °C for 60-120 minutes. Calcined kaolin clay was leached with 20-60 % sulfuric acid for 60-150 minutes at a temperature of 80-95 °C. It was revealed that leaching of kaolin clay in order to extract aluminum oxide is achieved using samples of kaolin clay calcined at 700 °C, 40 % sulfuric acid for 120 minutes at a leaching temperature of 95 °C. The degree of extraction of aluminum and iron oxide under these conditions is 95.6 and 85.2 %, respectively.

#### References:

- [1]. Dudkin B.N., Laukhina I.V., Isupov V.P., Avvakumov E.G. Mechanical activation of kaolinite in concentrated sulfuric acid. //Journal of Applied Chemistry, 2005. vol. 2. 70, no. 1, P. 36-40.
- [2]. Kipiakogona K.R., Giannopoulou I.K., Pnias D.S. Extraction of aluminum from kaolin: a comparative study of hydrometallurgical processes. //Proceedings of the 3rd World Congress on Mechanical Engineering, Chemistry and Materials Science (MCM'17). Rome, Italy – June 8-10, 2017, P. 1-6.
- [3]. Colina F.G., Esplugas S., Costa J.. High temperature reaction of kaolin with sulfuric acid. //Ind. Ing. Chem. Res., 2002, 41, P. 4160-4173.
- [4]. Layner Yu. A., Milkov G. A., Samoilov E. N. Promising cases of obtaining aluminum and compounds based on it // Non-ferrous metals. 2012. N°. 6. P. 42–47.

## SIZE AND STABILIZER - DEPENDENT CATALYTIC BEHAVIOR OF GOLD NANOPARTICLES

Aleksandrov Yu.D.<sup>1</sup>, Sergeyev V.G.<sup>1</sup>, Karpushkin E.A.<sup>1</sup><sup>1</sup> Moscow State University, Moscow, Russia

Postgraduate student

[Aleksandrov-Yura@yandex.ru](mailto:Aleksandrov-Yura@yandex.ru)

The 4-nitrophenol reduction reaction is used to study the catalytic properties of metal nanoparticles. During the reaction, the components are adsorbed onto the surface of metal nanoparticles, therefore, this reaction is often considered within the framework of the Langmuir-Hinshelwood mechanism [1]. The size and accessibility of the adsorption surface directly affect the rate of the catalytic reaction.

We investigated the effect of various stabilizers on the catalytic activity of gold nanoparticles: for this purpose, gold nanoparticles of the same size stabilized by various ligands were prepared and the effective rate constants of the catalytic reaction of the reduction of 4-NP were compared for different systems.

Series of gold Nanoparticles with an average size from 5 to 40 nm were obtained in the presence of sodium citrate and were chosen as reference ones. In the case of other ligands, the particle size depends on the nature of the stabilizer; for example, particles with sizes of 2.5 and 12 nm were obtained in the presence of PEI; 20 nm for glucose; 70nm and with carbon nanoparticles. UV spectroscopy, transmission electron microscopy, and dynamic light scattering were used to characterize the size of AuNP. In all cases, the shape of gold nanoparticles were spherical, with negative value of zeta potential except PEI.

The catalytic reaction was carried out under the same conditions varying the total amount of AuNP.

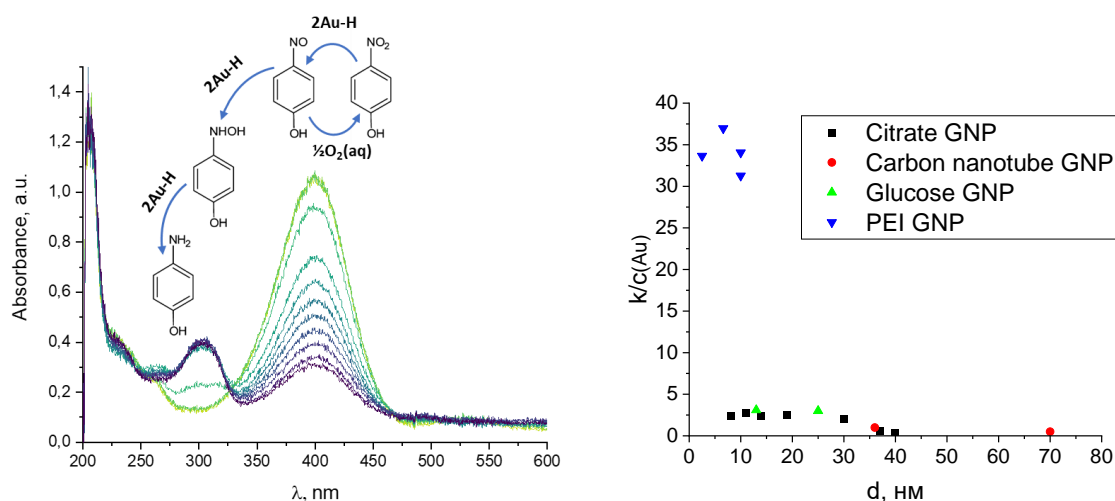

**Scheme 1.** a) Mechanism of 4-NP reduction and changing in UV-spectra  
b) Catalytic activity of gold nanoparticles with different stabilizers.

In accordance with the model of heterogeneous catalysis, the increase of surface area is proportional to the change in the rate of the catalytic reaction. But it isn't true for particles with sizes less than 20 nm. Surface of nanoparticles is not the entire available for catalysis. Comparison of different ligands show that the values of the constant rates for particles obtained in the presence of glucose, sodium citrate and carbon nanoparticles were the same. In the case of PEI, the rate of the catalytic reaction were 10 times higher.

### References

[1] Strachan J. et al. 4-Nitrophenol reduction: probing the putative mechanism of the model reaction //ACS Catalysis. – 2020. – T. 10. – №. 10. – C. 5516-5521.

### Acknowledgements

This work was supported by the Russian Science Foundation (grant 21-73-20144.).

## ACTIVATED CARBON FROM HIGH-DENSITY BIOMASS FOR ELECTRODES OF SUPERCAPACITORS ON NON-AQUEOUS ELECTROLYTES

*Borodina O.A.*<sup>1,2</sup>, *Yeletsky P.M.*<sup>1,2</sup>, *Lebedeva M.V.*<sup>1,2</sup>, *Mozyleva M.A.*<sup>1,2</sup>

<sup>1</sup>Novosibirsk State University, Novosibirsk, Russia

<sup>2</sup>Borokov Institute of Catalysis SB RAS, Novosibirsk, Russia

Student

[o.borodina@g.nsu.ru](mailto:o.borodina@g.nsu.ru)

Supercapacitors are widely used as power sources in electric and hybrid vehicles, as well as in electronics. Various porous materials are utilized for manufacturing supercapacitor electrodes, but the most accessible are still known to be activated carbons (ACs). Renewable biomass is a promising type of the feedstock of ACs. Fruit pits and nut shell are of particular interest due to their increased density and hardness, that can be inherited by ACs being obtained. In Russia, only pine nuts are currently harvested on an industrial scale (mainly in Siberia and Far East), the annual production of which is estimated at 35000 tons [1]. The shell is a waste constituting more than 50% of the whole nut weight.

The requirements to electrode materials for supercapacitors are the following: BET specific surface area ( $S_{\text{BET}}$ ) more than  $\sim 1500 \text{ m}^2/\text{g}$ , micro-mesoporous structure with high proportion of the effective surface area available for the electrolyte [2]. Phosphoric acid as an activating agent allows for achieving the required textural characteristics with the higher yield of ACs from biomass compared to other approaches [3].

In this work, a series of activated carbons was obtained with the yield of up to 47% and  $S_{\text{BET}}$  up to  $2500 \text{ m}^2/\text{g}$ . Their testing as supercapacitor electrode materials using 1M BMIMBF<sub>4</sub>/acetonitrile as an electrolyte showed that the electrode capacitance depends on both  $S_{\text{BET}}$  and pore size. It reaches ca. 120 F/g at a discharge current density of 0.2 A/g.

The work was carried out with financial support from the Ministry of Science and Higher Education of the Russian Federation within the framework of a state assignment for the Novosibirsk State University (project No. FSUS-2022-022), as well as for the Federal Research Center of the Borekov Institute of Catalysis SB RAS (project No. FWUR-2024-0038).

### References

- [1] <https://berekat.ru/info/articles/orekhi-2022-2023-proizvodstvo-predlozhenie-prognozy-kedrovye-i-gretskie-orekhi-pekan/>  
[2] Yeletsky P. M., Lebedeva M. V., Yakovlev V. A. // Journal of Energy Storage. 2022. (50). P. 1–28.  
[3] Alcañiz-Monge J., del Carmen Román-Martínez M., Lillo-Ródenas M.Á. // Molecules. 2022. (27). 1630. P. 1–26.

### Acknowledgements

The work was carried out with financial support from the Ministry of Science and Higher Education of the Russian Federation within the framework of a state assignment for the Novosibirsk State University (project No. FSUS-2022-022), as well as for the Federal Research Center of the Borekov Institute of Catalysis SB RAS (project No. FWUR-2024-0038).



PHYSICO-MECHANICAL PROPERTIES AND MICROSTRUCTURE OF CERAMICS MADE OF  
COMPOSITE MATERIALS OF DIAMOND-SILICON CARBIDE COMPOSITION

*Chekuryaev A.G.*<sup>1</sup>

<sup>1</sup> National Research Centre "Kurchatov Institute," Gorynin Central Research Institute of Structural  
Materials "Prometey", St. Petersburg, Russia

Graduate student

[achekuryaev@bk.ru](mailto:achekuryaev@bk.ru)

The development of modern science and technology requires the development of new ceramic materials with improved mechanical characteristics.

When performing this work, two ceramic materials were synthesized by reaction sintering from diamond powders of two types of fractions (20–28  $\mu\text{m}$  and 225–250  $\mu\text{m}$ ) - 30 vol. % fine fraction and 70 vol. % coarse (composition 1) and 25 vol. % fine fraction, 70 vol. % coarse and 5 vol. % carbon black (composition 2). The technology for producing this ceramic is described in detail in the work [1].

According to work [2], silicon impregnation during reaction sintering of workpieces from diamond particles of two fractions leads to the formation of a diamond-silicon carbide composite material (Ideal ceramics), the microstructure of which consists of triply periodic surfaces of silicon carbide synthesized on diamond particles. Under certain conditions, according to the Turing reaction-diffusion mechanism, silicon carbide grains form and grow, forming a "Turing fence" that fills the space between the diamond particles, forming a monolithic material – "Ideal" ceramics..

The physical and mechanical properties of Ideal ceramics far exceed the properties of standard reaction-sintered materials based on silicon carbide and boron carbide [3]. Table 1 shows measured data that allows us to distinguish "Ideal" ceramics in comparison with known ceramic materials.

**Table 1 - Physico-mechanical properties of reaction-sintered materials based on diamond, SiC and B<sub>4</sub>C**

Material	$\rho$ , g/cm <sup>3</sup>	E, GPa	$v$ , km/s	$\sigma_{\text{изг}}$ , MPa	$K_{1c}$ , MPa · m <sup>1/2</sup>	HV, GPa
Ceramics "Ideal":						
1	3,38	760	15	420	4,7	68
2	3,36	720	14,8	425	4,8	62
Reaction-sintered:						
SiC	3,05–3,10	380–410	10,2	380–400	3,5–4,0	20–21
B <sub>4</sub> C	2,60–2,65	380–420	11,8	350–380	3,2–3,5	28–30

Ideal ceramics, synthesized through the reaction-diffusion Turing mechanism, showed better mechanical characteristics compared to standard ceramic materials based on reaction-sintered silicon carbide and boron carbide.

#### References

- [1] *Russian Journal of Inorganic Chemistry* **2021**, 66. 8. 1107.  
[2] *Glass Physics and Chemistry* **2021**, 47. 4. 281.  
[3] *Refractories and Industrial Ceramics* **2022**, 62. 5. 548.

#### Acknowledgements

This work was supported by the Russian Science Foundation (project No 21-73-30019).

## STRUCTURE AND SURFACE STUDY OF TINI ALLOY AFTER PRELIMINARY MARTENSITIC ELECTROCHEMICAL TESTING

*Churakova A.A.<sup>1</sup>, Iskhakova E.I.<sup>1,2</sup>*

<sup>1</sup> Institute of Molecule and Crystal Physics - Subdivision of the Ufa Federal Research Center of the Russian Academy of Sciences, Ufa, Russia

<sup>2</sup> Ufa University of Science and Technology, Ufa, Russia  
Young scientist, Ph.D (Candidate of Physical and Mathematical Sciences)

[churakovaa\\_a@mail.ru](mailto:churakovaa_a@mail.ru)

Shape-memory alloys have found widespread application as functional materials across a range of industrial sectors [1]. However, there are practically no data on the corrosion and electrochemical properties of TiNi alloys, the study of mechanical behaviour in corrosive media and the analysis of corrosion fatigue of TiNi alloys with different microstructures are of particular interest. Studies on the influence of preliminary thermocycling (as an imitation of real conditions of titanium nickelide alloys) on the corrosion behaviour in coarse-grained (CG) and ultra-fine grained (UFG) states were carried out on  $Ti_{49.2}Ni_{50.8}$  alloy in biological solutions of 0.9% NaCl, Ringer's solution and Hanks' solution. A decrease in corrosion current density was observed with structure refinement, with the lowest corrosion current density in Ringer's solution. An increase in corrosion potential was observed in the states with additional thermocycling. The lowest corrosion current densities were found in Ringer's and Hanks' solutions in the UFG state. On the surface of the specimens, significant corrosion damage is observed in the form of pitting. In the CG condition, the pittings are smaller, approximately 0.8-1  $\mu m$  in size, whereas in the UFG structure specimen, the pittings are larger, reaching 2  $\mu m$ . The volume fraction of the corrosion lesions in the UFG condition is significantly higher than the volume fraction in the CG condition. The tests have shown that this alloy is more resistant to corrosion in the Hanks' solution.

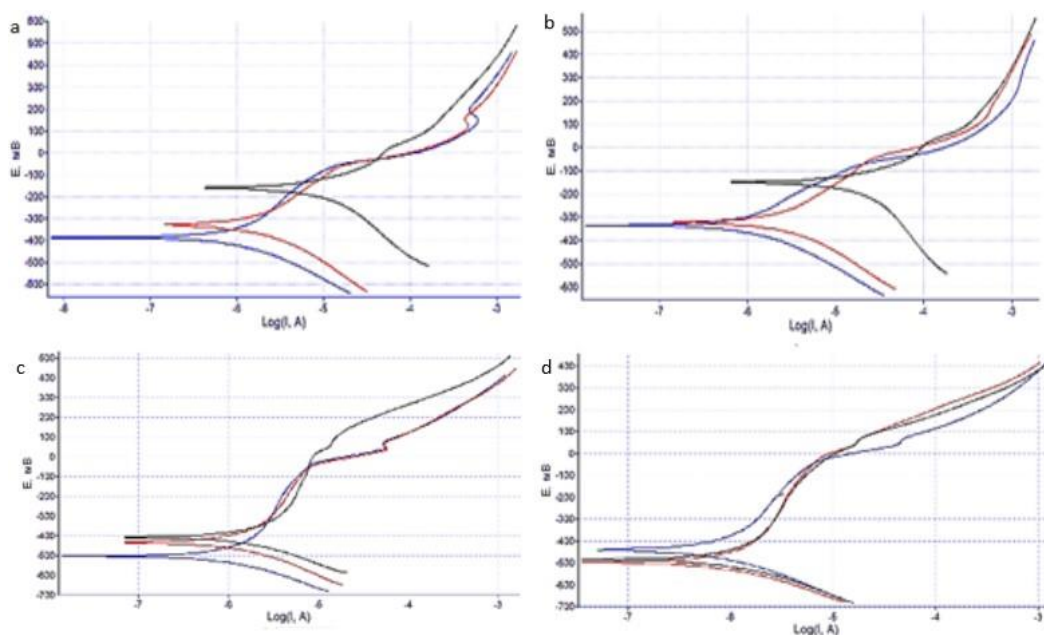

**Scheme 1.** Polarisation curves of  $Ti_{49.2}Ni_{50.8}$  alloy in coarse-grained (a), ultrafine-grained (b) states, coarse-grained (c), ultrafine-grained (d) states followed by thermocycling, where blue is Ringer's solution, red is 0.9% NaCl, black is Hanks' solution

### References

[1] Progress in Materials Science **2005**, 50, 511

### Acknowledgements

The study was supported by the Russian Science Foundation Grant No. 22-73-00289, <https://rscf.ru/project/22-73-00289/>. The work was carried out in the framework of the youth laboratory «Combined surface and bulk methods of processing of functional and structural materials» (No. CPD-ML-10/RF-23, 21.11.2023).

## LITHIUM ZIRCONATE SYNTHESIS BY PRECIPITATION METHOD

*Galiaskarova M.R.<sup>1</sup>, Kosykh A.S.<sup>1</sup>*

<sup>1</sup> Ural Federal University named first, Yekaterinburg, Russia,  
Graduate student  
[Sherlocked221b69@mail.ru](mailto:Sherlocked221b69@mail.ru)

Currently, research is widely carried out on the development of various methods for obtaining materials based on lithium zirconate. The most advanced methods are the solid-phase and sol-gel method [1, 2]. However, these methods do not allow to control the properties of the final powders. The method of controlled double-jet precipitation (CDJP), in turn, allows fine-tuning the characteristics of the materials obtained.

Lithium zirconate samples were synthesized by various deposition methods, namely direct, reverse and CDJP. The samples obtained using BWW and reverse deposition methods were synthesized at pH values from 3 to 8 units in increments of 1 unit. To obtain all samples, a solution of titanium chloride with a concentration of 0.5 mol/l was used as a source of titanium ions, and lithium hydroxide with a concentration of 2 mol/l was used as a precipitator. The resulting precipitates were subjected to heat treatment to obtain the required phase. The granulometric composition of all samples was measured by laser diffraction, the surface and porosity characteristics of the samples were determined by low-temperature nitrogen adsorption/desorption, and the phase composition was determined using X-ray phase analysis. The sorption properties of the samples were investigated by the potentiometric method.

It is shown that samples with a porous structure, developed surface and small particle sizes absorb lithium ions to a greater extent during deposition. All this can contribute to the effective diffusion of Li<sup>+</sup> ions.

### References

- [1] K. Narasimharao, T.T. Ali, *Ceram. Int.*, 42 , 2016, pp. 1318-1331
- [2] Q. Xiao, X. Tang, Y. Zhong, W. Zhu, *J. Am. Ceram. Soc.*, 95, 2012, p. 1444

A NEW APPROACH FOR OBTAINING COMPOSITE CERAMIC MATERIALS IN THE  $\text{Na}_2\text{O}-\text{CaO}-\text{SiO}_2-\text{P}_2\text{O}_5$  SYSTEM FOR MEDICAL APPLICATIONS

*Kaimonov M.R., Safronova T.V.*

Lomonosov Moscow State University, Moscow, Russia  
PhD student

[M.R.Kaimonov@yandex.ru](mailto:M.R.Kaimonov@yandex.ru)

Modern trends in medical material science, particularly in the area of import substitution, are leading to the search for alternatives to obtaining biomaterials that are both effective and affordable. One such alternative is the use of silicate bioceramic materials, which have been shown to be more bioactive in in vitro and in vivo tests than calcium phosphate ceramics. Ceramics incorporating both calcium phosphate and silicate components also have a synergistic effect. Typically, these composite materials are created using bioglass powders. The application of an aqueous solution of sodium silicate ( $\text{Na}_2\text{O}\cdot n\text{SiO}_2$ ) acts as a binder allows for the creation of highly biocompatible ceramic materials based on synthetic calcium phosphates (CPs). This results in a unique combination of properties for the finished product.

In this work, we studied a new approach to obtaining a composite biocompatible ceramic material based on synthetic calcium phosphates and an aqueous solution of sodium silicate for medical applications.

In the research, highly concentrated suspensions consisting of a dispersion medium and a dispersed phase were prepared. Synthetic calcium phosphate powders (hydroxyapatite, tricalcium phosphate and pyrophosphate) were used as the dispersed phase. The aqueous sodium silicate solution with the silica module ( $\text{SiO}_2/\text{Na}_2\text{O}$ ) of 2,87 was used as the dispersion medium. The initial powder mixture's composition was adjusted by adding calcium oxide CaO and sodium carbonate  $\text{Na}_2\text{CO}_3$ .

Pre-ceramic semi-finished products in the form of blocks were obtained by moulding in silicone moulds, and simple 3-dimensional layered geometric shapes were obtained by extrusion moulding using a syringe. The samples hardening occurred spontaneously both due to polycondensation of an aqueous sodium silicate solution and because of air-drying.

Ceramic materials after firing at  $1000^\circ\text{C}$  consisted of sodium-calcium silicate  $\text{Na}_6\text{Ca}_3\text{Si}_6\text{O}_{18}$  and  $\beta$ -rhenanite  $\beta\text{-NaCaPO}_4$ . The relative density of these materials obtained after firing at this temperature was  $\approx 28\%$ . It has been determined that both the bending and compressive strengths correspond to the strength limit for spongy bone. In vitro tests confirmed biocompatibility.

To sum it up, the highly concentrated suspensions based on synthetic calcium phosphates and the aqueous sodium silicate solution can be recommended for porous composite biomaterials preparation with both defined geometry and a porous architecture of implants using extrusion 3D printing. The approach proposed in the current work allows one to achieve a given phase composition of composite biocompatible ceramic materials in the  $\text{Na}_2\text{O}-\text{CaO}-\text{SiO}_2-\text{P}_2\text{O}_5$  system.

COPPER DEPOSITED CATALYST FOR THE ELECTROCHEMICAL REACTION OF REDUCTION  
NITRATES TO AMMONIA

*Kuznetsova I.I.<sup>1</sup>, Polykova O.V.<sup>1</sup>, Kultin D.Yu.,<sup>1</sup> Lebedeva O.K.,<sup>1</sup> Kustov L.M.<sup>1,2</sup>*

<sup>1</sup> Department of Chemistry, Lomonosov Moscow State University, Moscow, Russia

<sup>2</sup> N.D. Zelinsky Institute of Organic Chemistry, Russian Academy of Sciences, Moscow, Russia

PHD Student

[kuznetsowair@yandex.ru](mailto:kuznetsowair@yandex.ru)

The global demand for ammonia is growing with the universal development, as it is necessary in modern agriculture and industry. Currently, ammonia production is heavily dependent on the Haber-Bosch process, which must be carried out at high temperature and pressure, consumes large amounts of natural gas and leads to serious energy and environmental problems. The electrocatalytic reduction reaction of NO<sub>3</sub><sup>-</sup>RR nitrates has been widely studied for many years as one of the alternative methods [1]. Electrocatalytic reactions can serve as a substitute in a number of processes [2]. As a result of this reaction, it provides not only a stable synthesis of ammonia, but also eliminates environmental pollution.

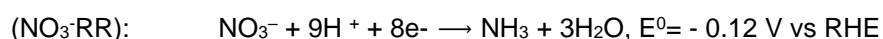

The most effective electrocatalysts today remain based on noble metals such as platinum, rhodium and especially ruthenium. The problem of replacing expensive such components with cheaper ones, such as nickel, titanium, and cobalt, is associated with a sharp decrease in catalytic efficiency. The task is to create electrocatalysts that could replace noble to inexpensive metals. In this case, copper is one of the most promising bases.

In this work, the task was not only to test Cu-containing electrocatalysts in NO<sub>3</sub>-RR, but also to check the substrates so that the mass of catalytic copper was as low as possible. An array copper electrode and a graphite substrate were chosen as substrates. Electrochemically deposited copper microparticles served as sources of active catalytic centers. To compare the catalytic activity, a copper electrode containing no active layer of microparticles was used.

Both the criterion of electrocatalytic activity and selectivity was the characteristic of the Faradaic efficiency (FE) for experiments that were conducted at a constant potential of the working electrode.

$$\text{FE}(\text{NH}_3) = \frac{8 \times 96500 \times m(\text{NH}_3)}{17 \times Q}$$

where Q is the total spent charge and m is the mass of the released target product (ammonia).

The experimental technique was used [3]. The tests were carried out at three constant potentials, which were selected using the method of cyclic and linear voltammetry. Electrocatalysts based on an array of copper with a deposited layer of copper microparticles showed the best results. The results for an electrocatalyst on a graphite substrate with a deposited layer of copper microparticles showed a comparable result (FE more than 20-25%). On an electrode without an active catalytic layer, the FE values did not exceed 13%.

Thus, Cu micro-catalysts were synthesized; a catalyst based on a graphite substrate, that is, from the cheapest materials, showed a result compatible with a self-supporting catalyst based on a copper array and copper nanoparticles. It has been shown that copper microparticles have catalytic activity in NO<sub>3</sub>-RR and can serve as a promising replacement for catalysts containing noble metals.

## References

- [1] *Nat. Catal.* **2023**, 6, 1125  
 [2] *Russ. Chem. Rev.* **2024**, 93, RCR5101.  
 [3] *Int. J. Mol. Sci.* **2023**, 24, 13373

## N-METHYL-N-PROPYLPYPERIDIUM PERCHLORATE DOPING BY LITHIUM PERCHLORATE AS ELECTROLYTE FOR LITHIUM-ION BATTERIES

*Kyzlasova D.A.<sup>1,2</sup>, Ulihin A.S.<sup>1</sup>, Uvarov N.F.<sup>1</sup>*

<sup>1</sup>Institute of Solid State Chemistry and Mechanochemistry of SB RAS, Novosibirsk, Russia

<sup>2</sup>Novosibirsk State University, Novosibirsk, Russia

Student

[d.kyzlasova@q.nsu.ru](mailto:d.kyzlasova@q.nsu.ru)

Lithium-ion batteries are widely used currently. However, there are some problems associated with their use. This is primarily due to safety, since the electrolyte uses volatile solvents that can be dangerous. The second problem is related to the increased power of the device. An electrolyte need have a wider electrochemical "window". To solve these problems, an electrolyte based on organic ionic plastic salts can be used. These electrolytes are thermally stable over a wide temperature range, have a high ionic conductivity and a wide window of electrochemical stability. N-methyl-N-propylpiperidinium perchlorate ( $[N_{13}pip]ClO_4$ ) is an example of this unique type of compound. The literature reports that a doping organic ionic plastic salts by lithium cations an electrolyte with high lithium-ion conductivity can be obtained [1]. As an ionic additive at this work lithium perchlorate was used.

The possibility of using binary system  $[N_{13}pip]ClO_4 - LiClO_4$  as the main electrolyte component for lithium-ion batteries was investigated. During the study, the thermal, electrochemical, and structural properties of both pure N-methyl-N-propylpiperidinium perchlorate and the system  $[N_{13}pip]ClO_4 - LiClO_4$  were investigated. The thermal properties were analyzed using differential scanning calorimetry (DSC). A phase diagram of the system is proposed. The structural properties were determined by X-ray diffraction (XRD). The formation of a new phase, which is a double salt, has been discovered. Electrochemical tests have shown that lithium perchlorate-based systems are electrochemically stable up to a voltage of 4.9 V (fig.1).

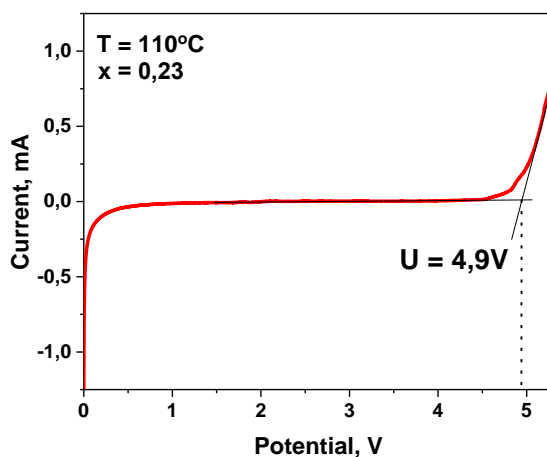

**Figure 1.** The voltage curve of the system  $(1-x)[N_{13}pip]ClO_4 \cdot xLiClO_4$ .

The long-term galvanostatic tests of a symmetrical cell with lithium electrodes were carried out. It was shown that ion transport in the systems under study is obtained by lithium cations.

### References

[1] *J. Power. Sources.* **2017**, 117, 10.

### Acknowledgements

This work was supported by the Russian Science Foundation (project N° 23-23-00556.).

## NOVEL THIAZOLOTHIAZOLE-BASED CONJUGATED POLYMER FOR THE INDOOR PHOTOVOLTAIC APPLICATIONS

*Lolaeva A.V.<sup>1</sup>, Zhivchikova A.N.<sup>1,2</sup>, Tepliakova M.M.<sup>2</sup>, Akkuratov A.V.<sup>1</sup>, Kuznetsov I.E.<sup>1</sup>*

<sup>1</sup> Federal Research Center of Problems of Chemical Physics and Medicinal Chemistry, Russian Academy of Sciences, Chernogolovka, Russia

<sup>2</sup> Skolkovo Institute of Science and Technology, Moscow, Russia

Junior research

[alina.lolaewa@yandex.ru](mailto:alina.lolaewa@yandex.ru)

Indoor photovoltaics (IPVs) have attracted considerable interest for their potential to power small portable electronics, photonic devices and the fastest energy supplements for growing technologies like Internet of Things (IoT) under indoor light conditions [1].

Herein, we report the synthesis and study of a novel conjugated polymer (PTBT-Tz), which provided outstanding performance of perovskite solar cells as hole-transport material (HTM) when combining with a wide-gap perovskite CsFAPbI<sub>3</sub>Br. The power conversion efficiency of devices reached of **19.31%** under indoor conditions surpassing that of the reference cells with state-of-the-art polytriarylamine (PTAA) HTM (PCE = **9.63%**).

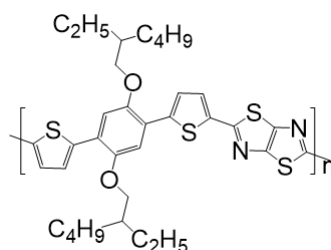

**Figure 1.** Conjugated polymer PTBT-Tz.

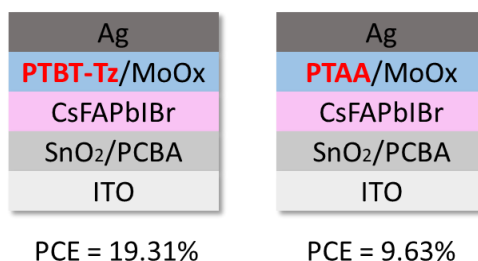

**Figure 2.** Schematic diagrams of perovskite solar cells.

### References

[1] *Chemical Science*. 2021, 12(36), 11936-11954

### Acknowledgements

Evaluation of the polymer PTBT-Tz in the indoor photovoltaic device was carried out within state assignment of Ministry of Science and Higher Education of the Russian Federation (project № 122111700041-8 (FFSG-2022-0004)).

SYNTHESIS AND STUDY OF OXIDE CERAMICS  $\text{Al}_2\text{O}_3$  STRUCTURES BY LASER SINTERING*Medvedev V.A.<sup>1</sup>, Mikhailov M.D.<sup>2</sup>, Manshina A.A.<sup>1</sup>*<sup>1</sup>Saint Petersburg State University, Saint Petersburg, Russia<sup>2</sup>S. I. Vavilov State Optical Institute

PhD student

[st063851@student.spbu.ru](mailto:st063851@student.spbu.ru)

Inorganic nanoparticles can act as precursors in the production of ceramics [1]. In this case, the advantage of using nanoparticles compared to powders of larger particles is the efficient occurrence of sintering, lower energy costs for this process, as well as the possibility of fine-tuning the composition, and therefore the optical/luminescent characteristics [2,3]. It is possible to produce ceramics from nanoparticles not only by standard hot sintering, but also by a number of other methods, among which stereolithography, laser sintering, technology of melting material in a layer, etc. are very popular. These methods make it possible to control the shape of the final ceramic element, which is important for such applied areas as instrument making, marking, etc.

Among the methods for producing various structures, including ceramics, techniques using laser exposure have high potential. The ability to focus laser radiation into a small surface area provides a high degree of spatial localization of the process, and therefore high-precision shape control, which determines the advantage of laser-based technologies over analogues in the production of luminescent ceramics from nanoparticles.

In this work,  $\text{Al}_2\text{O}_3$  nanoparticles were used as a starting material for producing ceramics on glass substrates.  $\text{Al}_2\text{O}_3$  ceramics was obtained as a result of laser-induced melting and/or recrystallization under wide range of laser parameters such as: laser radiation power, pulse repetition rate, processing time, number of laser scans. The results of X-ray diffraction analysis (XRD) demonstrated that the ceramics is characterized by the same characteristics XRD peaks as initial  $\text{Al}_2\text{O}_3$  nanoparticles. Morphology (SEM, optical microscopy) were obtained and analyzed.

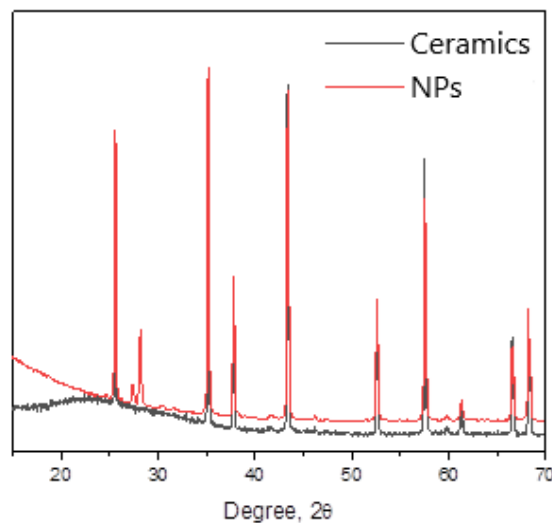

**Scheme 1.** XRD of  $\text{Al}_2\text{O}_3$  nanoparticles and ceramics on a glass surface.

### References

- [1] Zhang J. et al. Spark Plasma Sintering of High-Density Antimony-Doped Tin Oxide Ceramics from Nanoparticles // *Journal of the American Ceramic Society*. 2006. T. 89. № 12. C. 3874–3876.  
 [2] Chermahini M. D. et al. Low temperature sintering of magnetic  $\text{Ni}_0.5\text{Co}_0.5\text{Fe}_2\text{O}_4$  ceramics prepared from mechanochemically synthesized nanopowders // *Ceram Int*. 2019. T. 45. № 5. C. 5491–5495.  
 [3] Hou Y. et al. The fine-grained KNN–LN ceramics densified from nanoparticles obtained by an economical sol–gel route // *Mater Chem Phys*. 2012. T. 134. № 1. C. 518–522.

### Acknowledgements

Authors are grateful to “Interdisciplinary Resource Centre for Nano-technology”, “Research Centre for X-ray Diffraction Studies” and “Centre for Optical and Laser Materials Research” of Saint-Petersburg State University Research Park.



SYNTHESIS OF MIXED FERRITE  $\text{Co}_{0.5}\text{Zn}_{0.5}\text{Fe}_2\text{O}_4$   
 NANOPOWDER BY CITRATE COMBUSTION

Meshcheryakova A.A.,<sup>1</sup> Titov S.A.,<sup>1</sup> Tomina E.V.<sup>1,2</sup>

<sup>1</sup> Voronezh State University, Voronezh, Russia

<sup>2</sup> Voronezh State Forest Engineering University named after G.F. Morozov, Voronezh, Russia  
 PhD student

[anna-meshcheryakova@internet.ru](mailto:anna-meshcheryakova@internet.ru)

Mixed Ni-Co ferrites have been studied recently for their magnetostrictive, structural and magnetic properties. Synthesis of nano-scale ferrite materials are considerably the area of recent research as nano-ferrites have potential applications as catalysis, gas sensors, magnetic drug delivery and dye adsorbent. Approaches to synthesize nanoscale ferrites with spinel structure are diverse, but not all methods are suitable for scale-up due to the high cost, complex synthesis process, purity and quantity of the resulting substance. In this work, a solution combustion method characterized by high speed and productivity, simplicity and cost-effectiveness is used [1-2].

In the present work, synthesis of mixed Nickel-Cobalt spinel ferrite samples. Citrate combustion method has been employed for the synthesis of ferrites.

Mixed cobalt-zinc spinel ferrite was synthesized by mixing stoichiometric aqueous solutions of zinc nitrate  $[\text{Zn}(\text{NO}_3)_2] \cdot 6\text{H}_2\text{O}$ , cobalt nitrate  $[\text{Co}(\text{NO}_3)_2] \cdot 6\text{H}_2\text{O}$ , and iron nitrate  $[\text{Fe}(\text{NO}_3)_3] \cdot 9\text{H}_2\text{O}$ . At room temperature, citric acid was added to the solution, followed by ammonia until the pH value reached 7. The resulting solution was heated on a hotplate under continuous stirring at 60 °C for 30 min and then at 110 °C for 1 h until gel formation. The gel was additionally heated on a gas burner until the solution was completely burned off. The powder was annealed in a muffle furnace at 600 °C for 1 h, resulting in a nanosized ferrite nanopowder.

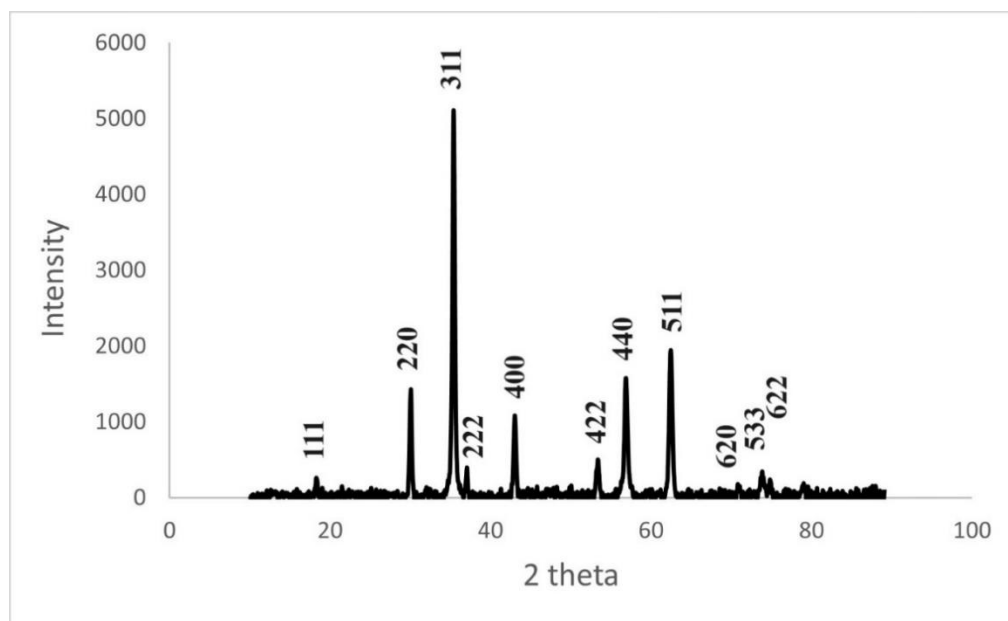

**Scheme 1.** Diffractogram of  $\text{Co}_{0.5}\text{Zn}_{0.5}\text{Fe}_2\text{O}_4$  nanopowder.

The phase composition of the synthesized sample of mixed Cobalt-Zinc ferrite was determined by X-ray phase analysis (XRD, X-ray diffractometer Empyrean B.V. with Cu anode ( $\lambda = 1.54060$  nm)). Imaging was performed in the angle range  $2\theta = 15-80^\circ$  with a step of  $0.0200^\circ$ .

According to XRD data, the nanopowder synthesized by the citrate combustion method contains target phases. The sample  $\text{Co}_{0.5}\text{Zn}_{0.5}\text{Fe}_2\text{O}_4$  is single phase.

#### References

- [1] *Environmental Research. Microwave assisted hydrothermally synthesized cobalt doped zinc ferrites nanoparticles for the degradation of organic dyes and antimicrobial applications.* **2022**, 208, 112687
- [2] *Materials Today. Proceedings.* **2021**, 46, 6527

## THE EFFECT OF ANTIOXIDANTS ON THE THERMAL OXIDATIVE STABILITY OF POLYURETHANES

*Perepada M.V.*

<sup>1</sup> Institute of Technical Chemistry of the Ural Branch of the Russian Academy of Sciences – a branch of the Perm Federal Research Center of the Ural Branch of the Russian Academy of Sciences, Perm.  
Postgraduate student  
[Mari.Perepada.@mai.ru](mailto:Mari.Perepada.@mai.ru)

Polyurethanes are polymers with a fairly wide range of properties. However, an area is allocated for the modification of polyurethanes to increase their stability under conditions of thermal oxidative degradation [1-2]. An increase in durability is possible due to technological techniques (adjustable ratio of hard and soft segments, frequency of crosslinking, introduction of urea groups), as well as the use of stabilizers or antioxidants.

In this paper, the effect of commercially available antioxidants (Neozone D, antioxidant 165 and 445) on the resistance of polyurethanes in conditions of elevated temperatures in oxygen is considered. The samples were synthesized according to the classical 2-stage method [3] based on oligoester (based on adipic acid and ethylene glycol), isoforondiisocyanate and MOCA for the standard sample and 1% antioxidant for modified samples. After manufacture, the samples were exposed to exposure for 16 days with control points, at which the strength level for the samples was determined according to Russian standards GOST 260-75. The results of the described tests are shown below (Figure 1.)

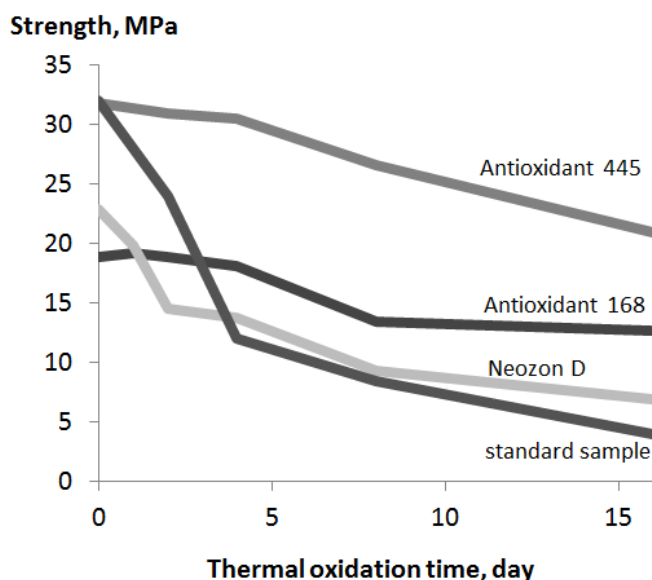

**Figure 1.** Change in the strength level during exposure at 100° C for samples with various antioxidants compared to a sample without an antioxidant (standard sample) .

As can be seen from the results, the maximum strength after exposure is possessed by a sample containing an antioxidant 445. When compared with a standard sample that does not contain an antioxidant, the strength decreases by 31% with an 85% decrease in the standard one. The lower efficiency of other products is probably due to lower compatibility with the polymer base. Most likely, the effectiveness of 445 is related to its activity relative to free radicals produced during thermal oxidative degradation[4].

### References

- [1] A.Y. Coran, N.R. Legge, G. Holden, H.G. Schroeder// Munich: Hanser Publ. – 1987 - P.133.
- [2] F. Coutinho, M. Delpech// Polym. Degrad. Stabil. – 2000 – Vol. 70 – P. 49–57
- [3] Tereshatov V.V et all. Russian Journal of Applied Chemistry, **2016**, 89, 943–948.
- [4] L.G. Lage, Y. Kawano // Journal Apply Polymer Science. - 2001 – Vol.79 – P. 910.

### Acknowledgements

The work was carried out within the framework of the State Assignment (theme-state registration number 124022200003-8) using the equipment of the Center for Collective Use "Investigations of materials and substances" of Perm Federal-Research Center of the Ural-Branch of the Russian Academy of Sciences.

## BIORESORPTION OF MAGNESIUM-BASED CERAMIC

*Preobrazhenskiy I.I., Klimashina E.S., Putlyayev V.I.*<sup>1</sup> Moscow State University, Moscow, Russia

PhD Student

[preo.ilya@yandex.ru](mailto:preo.ilya@yandex.ru)

Currently, the development of bioceramic materials for the treatment of bone tissue defect capable of resorbing in a biological environment is a pressing issue. This is because ceramic materials based on calcium phosphates such as hydroxyapatite ( $\text{Ca}_{10}(\text{PO}_4)_6(\text{OH})_2$ ) and tricalcium phosphate ( $\text{Ca}_3(\text{PO}_4)_2$ ) have a low dissolution rate [1, 2]. Magnesium phosphates could be considered as potential candidates for the development of such materials. Therefore, the aim of this study was to create bioceramic materials based on  $\text{Mg}_3(\text{PO}_4)_2$  and  $\text{Mg}_4\text{Na}(\text{PO}_4)_3$ , and to investigate the process of ceramic resorption in a simulated environment of citric acid solution.

Mixtures based on  $\text{Mg}_3(\text{PO}_4)_2$  and  $\text{Mg}_4\text{Na}(\text{PO}_4)_3$  were prepared to obtain ceramic materials. For the synthesis of magnesium orthophosphate ( $\text{Mg}_3(\text{PO}_4)_2$ ), a solid-phase method was used. The precursors used were magnesium oxide ( $\text{MgO}$ ) and magnesium pyrophosphate ( $\text{Mg}_2\text{P}_2\text{O}_7$ ), taken in a stoichiometric ratio. Double magnesium-sodium phosphates ( $\text{MgNaPO}_4$ ) were obtained by solid-phase synthesis according to a previously developed method [3-5]. Double magnesium-sodium phosphate,  $\text{MgNaPO}_4$ , was obtained by two-stage heat-treatment of a mixture of magnesium pyrophosphate and sodium carbonate,  $\text{Na}_2\text{CO}_3$ , at 900 °C and 600 °C with exposure for 10 hours.  $\text{Mg}_4\text{Na}(\text{PO}_4)_3$  was obtained by a solid-phase method from mixtures of  $\text{MgNaPO}_4$  and  $\text{Mg}_3(\text{PO}_4)_2$ . Ceramics based on these mixtures ( $\text{Mg}_3(\text{PO}_4)_2$  and  $\text{Mg}_4\text{Na}(\text{PO}_4)_3$ ) were produced by pressing tablets with a diameter of 8 mm. The mixtures were calculated based on the reaction:

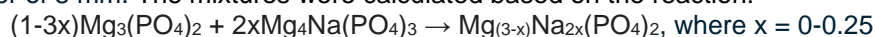

The resorption kinetics of magnesium-sodium phosphates ceramic granules was studied on the titrator with citric acid. In this work, pH=5 value was set to accelerate the resorption process.

The solubility of magnesium-sodium double phosphates in a model medium (citric acid) was evaluated, and it was shown that ceramic granules based on  $\text{Mg}_3(\text{PO}_4)_2$  and  $\text{Mg}_4\text{Na}(\text{PO}_4)_3$  are resorbed while maintaining pH = 5 for 1 day. The developed ceramic material is promising for bone replacement in regenerative medicine.

**References**

- [1] Materialia. **2023**, 28, 101742.
- [2] European Polymer Journal. **2024**, 112842.
- [3] Mendeleev Communications. **2023**, 33, 531.
- [4] Ceramics International. **2023**, 49, 29064.
- [5] Inorganic Materials. **2023**, 59, 500.

**Acknowledgements**

This work was supported by the Russian Science Foundation (project No 22-19-00219).

## DEVELOPMENT OF COMPLEX MORTARS BASED ON BENTONITE CLAY

*Shainova R.S.<sup>1</sup>, Karamyan H.H.<sup>1</sup>, Sahakyan A.T.<sup>1</sup>, Avagyan M. A.<sup>1</sup>, Aperyanyan A.J.<sup>2</sup>*

<sup>1</sup>National University of Architecture and Construction of Armenia, 105 Teryan Street, Yerevan 0009, Armenia

<sup>2</sup>Institute of Geological Sciences of the National Academy of Sciences of Armenia, Baghramyan ave. 24a, Yerevan, 0019, Armenia  
Researcher, PhD in Chemistry  
[rozetta\\_11@mail.ru](mailto:rozetta_11@mail.ru)

The production of cement is an energy-intensive process that generates significant carbon dioxide emissions. To reduce these emissions in both the short and long term, the best approach is to partially replace cement clinker with supplementary cementitious materials (SCMs). This necessitates the development of complex components [1-4].

Natural pozzolans, especially raw clays are widespread and the most promising source of SCM to serve the cement industry sufficiently for a more sustainable future. Since there is a growing interest of applying calcined clays in the construction industry, many countries started to evaluate the pozzolanic potential of local clay deposits [5-10].

After conducting extensive laboratory examinations, it was determined that the local raw materials exhibited the most favorable physical and mechanical properties compared with the observed Persian, Russian, and Armenian clays (Armenia, Nubarashen). In the cement/lime complex mortar, calcined clay powder served as a pozzolanic material, and its characteristics are listed in Table 1. Notably, the addition of a sulfate activator ( $\text{CaSO}_4 \cdot 0.5 \text{H}_2\text{O}$ ) to the composition led to the formation of hydrosilicates, calcium hydroaluminates, and hydrosulfoaluminates through chemical reactions.

Table 1.

Physico-mechanical and physico-chemical properties of fired clay

Temperatures of the calcined clay °C	Density g/cm <sup>3</sup>	Water absorption %		Compressive strength MPa		Flexural strength MPa	
		7 days	28 days	7 days	28 days	7 days	28 days
1. 400	1851	11.83	12.18	4.373	6.092	0.625	0.078
2. 600	1930	12.76	7.92	7.145	10.482	1.757	2.134
3. 1000	1914	12.52	10.31	6.445	8.638	0.834	0.976

According to the experimental data presented in Table 1, it was observed that clay fired at 600°C demonstrated the most favorable physical and mechanical properties.

### References

- [1] *Mater. Struct.* **2013**, 47, 1055.
- [2] *Cem. Concr. Res.* **2008**, 38, 115.
- [3] *Cem. Concr. Res.* **2004**, 34, 1489.
- [4] *Cem. Concr. Res.* **2015**, 78, 71.
- [5] *J. Clean. Prod.* **2016**, 124, 361.
- [6] *Appl. Clay Sci.* **2006**, 33, 79.
- [7] *Constr. Build. Mater.* **2012**, 28, 276.
- [8] *Appl. Clay Sci.* **2018**, 162, 391.
- [9] *Appl. Clay Sci.* **2016**, 133, 552.
- [10] *J. Compos. Sci.* **2023**, 7, 182.

## LUMINESCENCE CHARACTERISTICS OF NEW ANTHRACENE-BASED COMPOUNDS

Yulaev T.A.<sup>1</sup><sup>1</sup>Lomonosov Moscow State University, Moscow, Russia  
Student[YulaevAlpha@mail.ru](mailto:YulaevAlpha@mail.ru)

Anthracene-based organic semiconductors are attracting scientific interest due to their flexibility and easy-fabrication properties [1]. To date, it has been found that this type of semiconductor in its current form has a number of disadvantages. In particular, the semiconductor is highly susceptible to thermal degradation and aging. In this regard, a number of modifications have been proposed, where anthracene

derivatives as well as copolymers in which it is a component have been chosen as a base.

In this work, the luminescent properties of a block copolymer consisting of an anthracene derivative and a polymer with internal microporosity (PIM) were investigated by fluorescence spectrometry. The excitation and emission spectra of the block copolymers at different fractions of anthracene (AN = 5%, 10% и 20%) were investigated. In addition, spectra of pure PIM and anthracene (AN) were constructed. It was found that at a certain laser emission length, a transition of excitation from anthracene links to PIM links is observed at an excitation point of 350 nm. With the known values of the excitation point for anthracene (about 350 nm) and emission point for PIM (about 480 nm), it can be determined that under laser emission anthracene is excited and PIM fluoresces. The results obtained in this work may be useful for further development of organic semiconductors of the considered type.

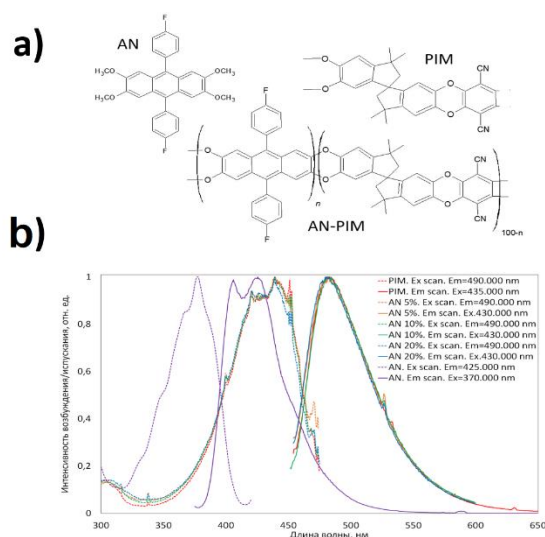

**Scheme 1.** (a) Chemical formula of anthracene derivative (AN), polymer with internal microporosity (PIM) and AN-PIM copolymer; (b) Excitation (Ex scan) and emission (Em scan) spectra of the corresponding compounds and copolymers of different composition.

## References

[1] Chen, Mengyun and Yan, Lijia and Zhao, *Journal of Materials Chemistry C*, 2018,6,7416-7444.

THE CONCEPT OF COMPOSITION SELECTION OF MULTICOMPONENT ADDITIVES FOR SELF-HEALING CEMENT HARDENING SYSTEMS

Zakatov A.B.<sup>1</sup>, Artamonova O.V.<sup>1</sup>

<sup>1</sup>Voronezh State Technical University, Voronezh, Russia  
Postgraduate student  
[zakatovartem@yandex.ru](mailto:zakatovartem@yandex.ru)

The sustainable development of building materials calls for the birth of self-healing concrete composites, which has the built-in ability to autonomously repair narrow cracks. This work reviews the fabrication, characterization, mechanisms and performances of autogenous healing concretes. Autogenous healing materials such as mineral admixtures, fibers, nanoparticles, fillers and curing agents have been proven to be effective to partially or even fully repair small cracks (less than 150 microns).

The mechanisms of autogenous healing can be identified as follows: 1) carbonization of calcium hydroxide; 2) healing of cracks caused by impurities in water and loose particles of newly formed cementitious material due to cracking; 3) expansion of the hydrated cement matrix at the edges of the crack; 4) continued hydration of (residual) cement grains [1]. The dominant factors influencing the effectiveness of self-healing in cementitious composites are the chemical composition and quantity of additives introduced, crack characteristics, and curing conditions.

The introduction of certain mineral additives (usually with high content), such as fly ash, blast furnace slag, carbonized steel slag, expansive agents, geomaterials, and chemical additives, contributes to the self-healing of cementitious composites. Practically all mineral additives are multicomponent, and the optimal combination would involve swelling substances and crystalline components based on silica.

The introduction of fibers (polyvinyl acetate fiber (PVA), polyethylene fiber (PE), polypropylene fiber (PP), steel fiber, and carbon fiber) is also an effective means of creating self-healing cement concrete. On one hand, fiber can limit crack width, thus enhancing self-healing efficiency as less healing material will be required to fill the cracks. On the other hand, fibers can play a crucial role in bridging cracks by attaching to them the crystallization products, thereby facilitating self-healing.

Numerous studies show that nanoparticles have significant potential for modifying cementitious composites due to their unique structure and properties [1]. Firstly, nanoparticles act as nucleation centers in the pore solution of hydration products, thereby accelerating hydration. Secondly, the introduction of nanoparticles improves the three-dimensional mesh structure of the cement matrix, forms finer cracks, and redistributes crack propagation direction. Thirdly, active nanoparticles, such as SiO<sub>2</sub> and TiO<sub>2</sub>-coated SiO<sub>2</sub> with pozzolanic reactivity, can react with Ca(OH)<sub>2</sub>, inducing additional hydration of calcium silicate, thereby increasing the density of specimens.

Internal curing, provided by expansive additives (hardeners), is another method aiding concrete in achieving self-healing properties. Expansive additives act as internal water reservoirs, absorbing and retaining water when there is excess, and gradually releasing the contained water into the unhydrated cement upon moisture gradient occurrence, sustaining continuous hydration. Consequently, autogenous and plastic shrinkage due to low water-to-binder ratio can be significantly reduced. Common hardeners include lightweight aggregates such as expanded clay and pumice, as well as chemical additives, for example, superabsorbent polymers.

Self-healing technology provides concrete infrastructures with the ability to adapt and respond to the environment, exhibiting a great potential to facilitate the creation of a wide variety of resilient materials and infrastructures.

#### References

[1] Zhang W., Zheng Q., Ashour A., et al. Self-healing cement concrete composites for resilient infrastructures: A review // Composites Part B. 2020. V. 189. Pp. 107892.



# **MODERN TRENDS IN POLYMER SCIENCE**



# **KEYNOTE & INVITED SPEAKERS**





## KEYNOTE SPEAKER



**Dr. Sci., Prof. Alexei Volkov**

*Professor of the Russian Academy of Sciences, A.V. Topchiev Institute of Petrochemical Synthesis Russian Academy of Sciences, Moscow, Russia*

**Polymers for Separation on Molecular Level**

## INVITED SPEAKER

**Dr. Tatiana Plisko**

*St Petersburg University, St. Petersburg, Russia*

**Influence of Molecular Weight and Concentration of Poly(Diallyldimethylammonium Chloride) Added to Coagulant on the Structure and Performance of Thin Film Composite Membranes for Nanofiltration**



POLYMERS FOR SEPARATION ON MOLECULAR LEVEL

*Volkov A.V.*

A.V. Topchiev Institute of Petrochemical Synthesis Russian Academy of Sciences, Moscow, Russia  
Professor of the Russian Academy of Sciences

[avolkov@ips.ac.ru](mailto:avolkov@ips.ac.ru)

Up to 70% of OPEX in industry is associated with separation and purification steps, and the membrane processes enabling the separation on molecular can provide higher efficiency due to lower energy penalties and unit size. It will be shown how the membrane separation processes mimic the biological membranes and organs of our body. For instance, the production of fresh water by nanofiltration is acting as the membrane cell allowing one type of ions passing through, while other ions are rejected. The membranes can be also change the chemical processes such as crude oil fraction by replacing of distillation process.

INFLUENCE OF MOLECULAR WEIGHT AND CONCENTRATION OF  
POLY(DIALLYLDIMETHYLAMMONIUM CHLORIDE) ADDED TO COAGULANT ON THE  
STRUCTURE AND PERFORMANCE OF THIN FILM COMPOSITE MEMBRANES FOR  
NANOFILTRATION

*Plisko T.V.<sup>1</sup>, Burts K.S.<sup>1</sup>, Penkova A.V.<sup>1</sup>, Bilyukevich A.V.<sup>2</sup>*

<sup>1</sup> St. Petersburg State University, 7/9 Universitetskaya nab., 199034, St. Petersburg, Russia

<sup>2</sup> Institute of Physical Organic Chemistry, National Academy of Sciences of Belarus, 220072 Minsk, Belarus

Leading Researcher

[t.plisko@spbu.ru](mailto:t.plisko@spbu.ru)

The perspective technique of membrane modification is the introduction of hydrophilic polymers or polyelectrolytes into the coagulation bath during membrane preparation via non-solvent induced phase separation (NIPS). This technique can contribute to surface modification due to the embedding of hydrophilic polymers or polyelectrolytes into the selective layer, which yields changes in the hydrophilicity, roughness, charge and chemical composition of the membrane selective layer. It is known that structure (pore size, porosity, surface roughness) and surface properties (hydrophilicity, zeta potential) of porous membrane-supports significantly effects the formation and performance of the polyamide layer of thin film composite membranes prepared via interfacial polymerization (IP). The aim of the research was to study the influence of molecular weight and concentration of poly(diallyldimethylammonium chloride) (PDADMAC) used as an additive to coagulation bath during preparation of polysulfone substrate membrane via NIPS on the structure and performance of thin film composite membrane (TFC) for nanofiltration obtained via IP. PDADMAC with the molecular weight of 100 kDa, 200-350 kDa and 400-500 kDa was used as an additive to aqueous coagulation bath during polysulfone membrane preparation. It was found that introduction of PDADMAC to coagulation bath and increase in its concentration up to 0.15 wt.% yielded in the decrease of membrane pure water flux from 280 L·m<sup>-2</sup>·h<sup>-1</sup> down to 160 L·m<sup>-2</sup>·h<sup>-1</sup> (at transmembrane pressure of 1 bar) and increase in polyvinylpyrrolidone K-30 (Mn=40 000 g·mol<sup>-1</sup>) rejection from 77% to 80-86%. It was shown that modification of membranes using PDADMAC led to hydrophilization of porous membranes-supports. However, the higher the molecular weight of PDADMAC resulted in the higher water contact angle of membrane selective layer. Thin polyamide layer was formed on the surface of polysulfone porous membrane supports via IP of piperazine aqueous solution and trimesoyl chloride solution in hexane. TFC membrane performance was studied in nanofiltration of salts (NaCl, Na<sub>2</sub>SO<sub>4</sub>, MgSO<sub>4</sub>, CaCl<sub>2</sub>, MgCl<sub>2</sub>), dye (indigo carmine) and antibiotic (sulfadimethoxine) aqueous solutions at transmembrane pressure of 5 bar.

It was found that introduction of PDADMAC yielded the significant increase in water permeability (from 14 to 79 L·m<sup>-2</sup>·h<sup>-1</sup> at 5 bar) and rejection of MgSO<sub>4</sub> from 91 to 95% of nanofiltration membranes. It was found that increase in concentration of the additive of PDADMAC in coagulation bath increased the rejection of NaCl (0.5 g·L<sup>-1</sup> aqueous solution) from 19 to 32-54%. Thus, introduction of PDADMAC to coagulation bath during membrane preparation via NIPS is an efficient tool to tune surface properties of membrane selective layer which significantly influences formation of thin polyamide layer via IP.

**Acknowledgements**

This work was supported by the Russian Science Foundation (project No 22-73-10034).



# **ORAL & POSTER PRESENTATIONS**

## INTERPOLYMER COMPOSITES OF POLYESTERS WITH POLYSACCHARIDES

*Alikparova E.R.*<sup>1</sup>, *Guliaeva P.S.*<sup>1</sup>, *Sinitsyna E.S.*<sup>1</sup>, *Korzhikov-Vlakh V.A.*<sup>1</sup>, *Korzhikova-Vlakh E.G.*<sup>1</sup>,  
*Tennikova T.B.*<sup>1</sup>

<sup>1</sup> St. Petersburg State University, St. Petersburg, Russia

Student

[e.alikparova@gmail.com](mailto:e.alikparova@gmail.com)

Many synthetic and natural polymers find their place in the development of products for biomedical research and applications [1]. However, objects based on pure polymers are limited to conceptual use and prototyping because they have unsatisfactory mechanical properties. In addition, they usually do not meet the required functional characteristics such as cell adhesion, bioactivity, etc. Therefore, combining two or more polymers to obtain interpolymer composites is an important task to achieve suitable characteristics due to the synergistic effect of the two polymers. The main purpose of obtaining such composites is to vary and improve the properties in terms of mechanical properties of the material as well as their suitability for the realization of a particular technology [2]. Currently, of importance are attempts to prepare polyesters composites with hydrophilic polymers, which should improve hemocompatibility and biointeractions of biomaterials.

In current study we were aimed to obtain interpolymer composites combining relatively hydrophobic poly(lactic acid) (PLA), poly(caprolactone) (PCL) with hydrophilic polysaccharides. Hydrophobic modification of polysaccharides (cellulose, alginate, guar gum) with stearic acid and isoleucine allowed forming their stable mixtures with PLA/PCL. Such hydrophobic modifiers provided necessary cohesion forces between natural polymer and polyesters.

Preparation of interpolymer biocomposites was carried out by two approaches: (1) mechanical mixing in the melt using rollers, and (2) formation of material from a mixed solution/suspension in a volatile solvent. Obtained materials were investigated by thermogravimetry, differential scanning calorimetry and X-ray phase analysis, in order to determine the microphase composition. The mechanical properties of the composites were evaluated, using a tensile machine and dynamic mechanical analysis. Optical and scanning electron microscopy methods allowed analyzing morphological features of interpolymer composites.

Obtained results allowed us to form polyesters with different content of polysaccharides. Such composites will be further applied for preparation of 3D scaffolds for bone tissue engineering via 3D printing method.

### References

- [1] *Polymers*. **2020**, *12*, 1765
- [2] *ACS Biomater. Sci. Eng.* **2016**, *2*, 1679

### Acknowledgements

This work was supported by a grant of the Ministry of Science and Higher Education of the Russian Federation for large scientific project in priority areas of scientific and technological development (grant number 075-15-2024-553).

## NANOPARTICLES BASED ON AMPHIPHILIC COPOLYMERS FOR COMBINATION DRUG DELIVERY

*Bagaeva I.O.*<sup>1</sup>, *Sinitsyna E.S.*<sup>1,2</sup>, *Tennikova T.B.*<sup>1</sup>, *Korzhihova-Vlakh E.G.*<sup>1,2</sup>

<sup>1</sup> Institute of Chemistry, St. Petersburg State University, St. Petersburg, Russia

<sup>2</sup> Institute of Macromolecular Compounds, Russian Academy of Sciences, St. Petersburg, Russia  
Student

[Bagaeva\\_irina2000@rambler.ru](mailto:Bagaeva_irina2000@rambler.ru)

Currently, cancer therapy efficiency is significantly limited due to high toxicity and low bioavailability of cytostatic drugs. Recently, the *in vivo* studies have shown that the use of polymeric systems for co-delivery of gene therapy agents and cytotoxic drugs enhances treatment efficacy. The development of such formulations involves the use of biocompatible and biodegradable polymeric carriers with the necessary charge and physicochemical properties. For successful loading and delivery of drugs of different nature, the polymeric system should include various polymer moieties with corresponding properties: (1) a hydrophobic block responsible for particle formation and encapsulation of hydrophobic drugs, (2) a cationic block responsible for electrostatic binding to negative chains of nucleic acids and (3) a hydrophilic block to ensure stability of delivery systems *in vivo*.

Recently, we have developed and characterized mPEG-*b*-PCL block copolymer-based nanoparticles as delivery systems for the anticancer drug dioxadet (DOD) [1]. The aim of this work was to prepare the nanoparticles based on an amphiphilic block-copolymer of poly(ethylene glycol) (PEG) with poly( $\epsilon$ -caprolactone) (PCL) and poly(L-lysine) (PLys) and to test the suitability of developed nanoparticles for a combined delivery of DOD and siRNA.

At first step, the mPEG-*b*-PCL-OH and H<sub>2</sub>N-PEG-*b*-PCL-OH block copolymers were obtained by ring-opening polymerization of  $\epsilon$ -caprolactone using mPEG and H<sub>2</sub>N-PEG-OH as macroinitiators. The next step involved modification of the terminal hydroxyl group of mPEG-*b*-PCL-OH to an azide one followed by azide-alkyne 1,3-dipolar cycloaddition with the alkyne-containing linker bearing also a primary amino group. After that, PLys block was formed by two ways. The first one was based on the ring-opening polymerization of *N* $\alpha$ -carboxyanhydride (*N*-CA) of Lys(Z) initiated by a primary amino group of mPEG-*b*-PCL-DBCO-NH-Et-NH<sub>2</sub> and CBZ-O-PCL-*b*-PEG-NH<sub>2</sub> due to nucleophilic attack on the 5-carbonyl of *N*-CA. The second method involved the use of the hydroxyl group of mPEG-*b*-PCL-OH as a nucleophile for the same polymerization.

Molecular weights and dispersity of the synthesized copolymers were analyzed by size-exclusion chromatography. The structure and degree of modification of the obtained block copolymers were confirmed by NMR and IR spectroscopy.

Nanoparticles based on block copolymers were obtained by nanoprecipitation. The particles were characterized by narrow size distribution and positive surface charge. DOD was encapsulated into nanoparticles by nanoprecipitation technique. The stability study of empty and DOD loaded nanoparticles was carried out at 4 °C and RT. In addition, due to the positive surface zeta potential, both empty particles and DOD-loaded nanomedicines were tested for loading of the 23 b.p. duplex of oligothymidine and oligoadenine (oligo-dT-dA). The encapsulation efficiency of oligo-dT-dA into the developed nanoparticles was analyzed by dynamic and electrophoretic light scattering and agarose gel electrophoresis.

The cytotoxicity of the obtained empty nanoparticles was evaluated by MTT assay. Human embryonic kidney cell line (HEK-293) was used for cytotoxicity study.

### References

[1] *Pharmaceutics*. **2022**, 14, 2506.

### Acknowledgements

This work was supported by the Russian Science Foundation (project No 21-73-20104). Center for Magnetic Resonance of the Research Park of St. Petersburg State University is acknowledged for the performance of NMR analysis.

# PROPERTIES OF POLYMER MATERIALS BASED ON COMPOSITIONS OF POLYCAPROLACTONE-CHITOSAN-MEDICINAL SUBSTANCE

*Bakirova E.R.*<sup>1</sup>

Ufa University of Science and Technology, Ufa, Russia

Postgraduate

[elina\\_bakirova@mail.ru](mailto:elina_bakirova@mail.ru)

The creation of modern polymer-based film coatings designed to protect and treat wounds of various etiologies is a complex and multidisciplinary task. The modern market of protective wound coatings offers a number of materials, mainly based on chitosan and collagen. These materials have proven themselves well in the case of superficial burns and cuts, as well as uninfected wounds. Nevertheless, the development of new, improved materials is necessary for the treatment of deep burns, trophic ulcers and pressure sores. Thus, the purpose of this work was to create polymer film materials based on polycaprolactone (PCL) with chitosan and the addition of a medicinal substance. The choice of PCL as a base is related to its biocompatibility with body tissues and its ability to biodegrade. A biocompatible, biodegradable polymer chitosan was used as a hydrophilic filler, among the positive properties of which are bacteriostaticity and shortening of epithelialization time. A broad-spectrum antibiotic, ceftriaxone, was used as a model drug.

A sample of PCL of the Ecoplastic brand (China) was used in the work with a degree of crystallinity of 69% and a molecular weight of 63,000 Da, chitosan ("Bioprogress", Russia) with a molecular weight of 116,000 Da and an average particle size of 0.05 mm, ceftriaxone sodium salt ("Biosynthesis", Russia). The compositions based on PCL were obtained on a laboratory plastograph (Brabener, USA) at a temperature of 80 °C, a mixing time of 10 minutes and a rotor rotation speed of 10 rpm. After the plasticization process, the composite samples were placed in an automatic hydraulic press (Carver, USA) to form 0.3 mm thick films. The temperature in the press was 80 °C, the pressure was 1000 kgf. The choice of processing conditions is due to the earlier optimization of the process [1]. The chitosan content in the film did not exceed 70 mass parts due to the difficulties of processing a composition with a large amount of non-melting filler by melt technology [2]. The ceftriaxone content varied from 2.5 to 10.0% of the total weight of the polymers in the mixture. A certain amount of medicinal substance was evenly distributed in the chitosan suspension, after which the mixture was introduced into the PCL. Tests of the resulting materials for rupture were carried out on a universal testing machine (Shimadzu, Japan). Experiments on the sorption of water by films were carried out at 100% humidity under thermostatically controlled conditions (T = 37 °C). The degree of swelling was determined as the ratio of the mass of water absorbed by the film at the time to the initial mass of the film. The kinetics of the release of medicinal substances from films into an aqueous medium was studied by UV spectrophotometry in the region of maximum absorption of ceftriaxone at a temperature of 37 °C. The concentration of ceftriaxone in the aqueous medium was determined by the calibration curve. The proportion of ceftriaxone released from the film at the time was determined as the ratio of concentration to concentration of ceftriaxone introduced into the film. Microbiological activity was assessed by suppressing the growth zone with samples of the studied compositions with a diameter of 0.5 mm of *Staphylococcus aureus* and *Pseudomonas aeruginosa*. To study the hydrolysis of polymer compositions, the studied samples of a known mass were placed in a saline solution and kept for a long time at room temperature. The degree of hydrolysis was determined by gravimetric method, measuring at certain intervals the mass of the samples relative to the initial mass of the films.

In the course of the work done, it was proved that film materials based on PCL, chitosan and ceftriaxone are characterized by microbiological activity against *Staphylococcus aureus* and *Pseudomonas aeruginosa* at the level of the initial activity of the medicinal substance. It was found that the presence of chitosan in the composition leads to an increase in the moisture absorption capacity of the material and accelerated hydrolytic degradation. It has been proven that by regulating the content of ceftriaxone and chitosan in a PCL-based composition, it is possible to regulate the rate of release of the drug from the film coating. The more chitosan and ceftriaxone are in the composition, the faster the medicinal substance leaves the material. It is shown that the presence of chitosan in the composition is accompanied by an increase in the modulus of elasticity, a decrease in strength, as well as a significant decrease in the values of tensile elongation compared with films of individual PCL.

## References

- [1] *Butlerov Communications B.* **2023**, 74, 4, 72-76.
- [2] *Physics and technology of advanced materials - 2023: Proceedings of the International Conference, Ufa*, **2023**, 37-39.

## INFLUENCE OF THE NATURE OF THE LIQUID PHASE IN THE IONOMER'S DISPERSION ON ITS CONFORMATION AND FILMS MICROSTRUCTURE.

*Baturina E.P.<sup>1</sup>, Golubkov S.S.<sup>1</sup>, Statsenko T. G.<sup>1</sup>, Don G.M.<sup>2</sup>, Lihomanov V.S.<sup>1</sup>, Vinyukov A.V.<sup>2</sup>, Kashin A.M.,<sup>1</sup> Maryasevskaya A.V.<sup>3</sup>, Levchenko A.V.<sup>2</sup>, Ivanov D. A.<sup>3</sup>, Morozova S.M.<sup>1</sup>*

<sup>1</sup>Moscow Institute of Physics and Technology, National Research Institute, Institutsky Lane, d 9, Dolgoprudny, Russia

<sup>2</sup>Federal Research Center for Problems of Chemical Physics and Medical Chemistry of the Russian Academy of Sciences, Academician Semenov Ave., 1, Chernogolovka

<sup>3</sup>Lomonosov Moscow State University, GSP-1, 1-3 Leninskiye Gory, 119991 Moscow, Russia  
Student

[baturina.ep@phystech.edu](mailto:baturina.ep@phystech.edu)

Prospective branch of sustainable power sources is hydrogen energetics, moreover, ongoing researches in the field focused on the developing of proton exchange membrane fuel cells (PEMFCs). Their significant advantage over the solar cells, wind and hydro power sources lies in the zero emission, independence from weather conditions, simple system construction and high energy efficiency (approximately 60%).

Perfluorinated ionomers with short side chain, such as Aquivion®, exhibit unique properties, including high thermal stability, improved chemical resistance, and high ionic conductivity which make them promising candidate for fuel cell applications. The aim of this study was to investigate of the impact of the liquid media of ionomers dispersions on copolymer conformation and film structure.

The perfluorinated copolymer with Aquivion type structure consisting from alternating hydrophobic tetrafluoroethylene blocks and hydrophilic blocks containing sulfonate groups were synthesized (Fig. 1a). Equivalent weight (EW) of the copolymer characterizes the concentration of sulfonic acid groups in the polymer volume and was 850, which according to the literature data is the most promising for obtaining high electrochemical characteristics. Next, polymer dispersions in different liquids media was obtained using high pressure homogenizer. Depending on the nature of liquid phase pressure was ranging from 50 MPa to 100 MPa with subsequent heating and, where it was necessary, centrifugation at 20,000G to eliminate large particles. Received samples were stable for approximately several weeks, however, after 1 month storage of the dispersions precipitate was observed.

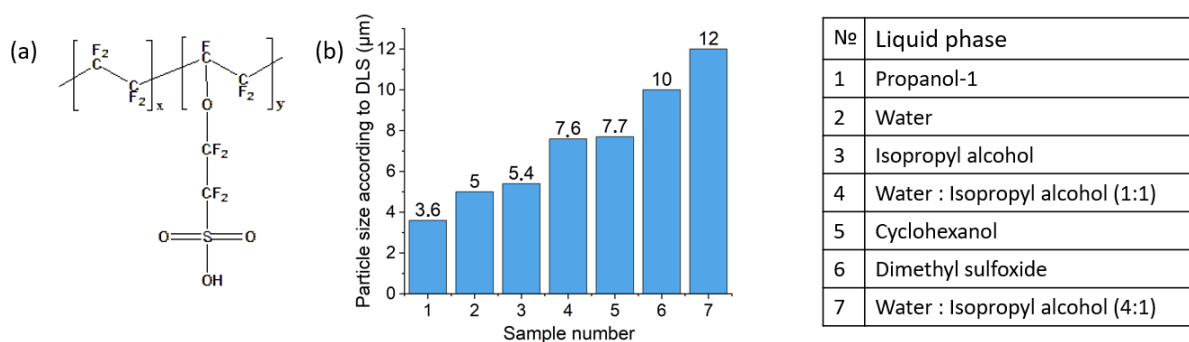

**Scheme 1.** a) Chemical structure of the copolymer (Aquivion); (b) Bar chart of the particles size in different solvents

Particle size in dispersion was studied by dynamic light scattering (DLS), and was from 3.6 to 12 µm depending on the nature of liquid phase (Fig. 1b). Small Angle X-ray scattering of the dispersions revealed nanoscale microstructure of the copolymer. Films from the dispersions were obtained by solvent casting and their ionic conductivity were studied.

### Acknowledgements

This work was supported by the Ministry of Science and Higher Education of the Russian Federation (Goszadaniye) 075-03-2023-106, project No FSMG-2022-0012.



# POLY(N-ISOPROPYLACRYLAMIDE) IS THE BASIS OF STIMULUS-RESPONSIBLE MATERIALS FOR THE CREATION OF ACTUATORS AND CELLULAR SCAFFOLDS

*Belyaeva A.A.*<sup>1,2</sup>, *Averchyk A.S.*<sup>1,3</sup>, *Korzhihova-Vlakh E.G.*<sup>4</sup>, *Salmina A.B.*<sup>1,3</sup>, *Morozova S.M.*<sup>1</sup>

<sup>1</sup> N.E. Bauman Moscow State Technical University, Moscow, Russia

<sup>2</sup> Institute of Physiologically Active Compounds at Federal Research Center of Problems of Chemical Physics and Medicinal Chemistry, RAS, Chernogolovka, Russia

<sup>3</sup> Research Center of Neurology, Moscow, Russia

<sup>4</sup> Institute of Macromolecular Compounds of RAS, St. Petersburg, Russia

PhD Student

[belanastal\\_a@mail.ru](mailto:belanastal_a@mail.ru)

Hydrogels are promising for medical applications due to their biocompatibility, suitability to additive manufacturing and variable mechanical properties. Introduction to this materials stimuli-responsive properties makes them an ideal candidate for creating soft actuators and cellular scaffolds.

The goal of the work was to obtain three types of stimulus-responsive hydrogels for biomedical applications based on nanocrystalline cellulose (CNC) and poly(N-isopropylacrylamide) (PNIPAM). Following systems were developed: i) physical gel based on PNIPAM/CNC as injectable drug delivery system (Fig. 1a) [1]; ii) thermoresponsive gel based on CNC grafted PNIPAM for brain implants (Fig. 1b); and iii) covalent gels PNIPAM and CNC for fabrication soft actuators (Fig. 1c) [2].

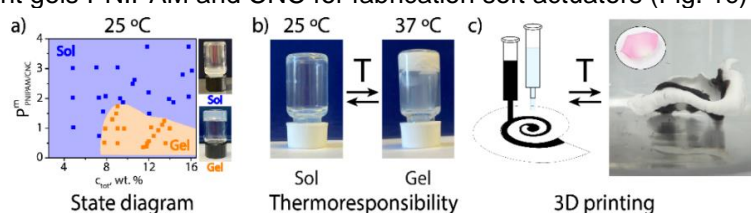

**Figure 1.** a) state diagram for the mixture PNIPAM/CNC at 25°C; b) appearance of aqueous dispersion of CNC grafted PNIPAM at sol state at 25°C (left) and gel state at 37°C (right); c) rose-petal shape actuation scheme (left) and shape transformation of the material at 37°C (right). Actuation shape transformation inspired by *Rosa odorata*.

In first direction, diagrams of the PNIPAM/CNC system state at 25°C and above the lower critical dissolution temperature of PNIPAM (32°C) have been studied (fig.1a). By varying the ratio of components, the mechanical properties of the gel can be controlled (to change the shear modulus,  $G'$ , from 23 to 667 Pa). The hydrogels can reversibly change their transparency from translucent (25°C) to opaque (37°C). The fibrillar structure of the gel, its thixotropic properties, as well as biocompatibility with human epidermal cells (A-431), make it promising for the creation of implants and drug delivery systems [1].

Second direction was devoted to formation of materials with thermosensitive gelation for utilization as implants in surgically removed brain parts. This material consists of CNC grafted with PNIPAM synthesized by reversible addition-fragmentation chain-transfer polymerization with a molecular weight of 35,000 Da and a narrow molecular weight distribution. This system was capable to form thixotropic gels at temperatures  $>35^{\circ}\text{C}$  at concentrations of 2-5 wt.% and demonstrated biocompatibility (astrocytes and endothelial cells). The concentration of the gel was selected to match its rheological properties to the parameters of the gray matter of the brain.

The third direction was related with creation a soft actuator that can mimics the natural motion of plants. Two types of inks, magnetically and thermoresponsive, have been developed for 3D extrusion printing, from which a single-layer soft actuator with a predetermined inks distribution was made. The possibility of obtaining various shapes (roll, spiral, petal and grab), as well as the ability to move the actuator under the influence of a magnetic field, is shown. The biocompatibility of the components and the operating temperature of the activator make it promising for use in medicine at human body temperature [2].

## References

[1] *J. Colloid Interface Sci.* **2023**, 635, 348-357

[2] *Mater. Today Commun.* **2024**, 108879

## Acknowledgements

This work was supported by the Russian Science Foundation (project №21-79-20113). This work was carried out using equipment of the St. Petersburg University Research Park.

# NOVEL MIKTOARM STAR POLYMERS WITH A CALIX[8]ARENE CORE AND PEG/POLYOXAZOLINE ARMS

*Blokhin A.N.<sup>1</sup>, Kozina N.D.<sup>1</sup>, Razina A.B.<sup>1</sup>, Tenkovtsev A.V.<sup>1</sup>*

<sup>1</sup> Institute of macromolecular compounds RAS, St. Petersburg, Russia

Senior researcher, PhD

[blokhin\\_an@hq.macro.ru](mailto:blokhin_an@hq.macro.ru)

Miktoarm star polymers are a new promising class of polymers with arms of different chemical nature grafted onto a single branching center. Varying the structure of the arms in the amphiphilic macromolecules makes it possible to finely regulate their physicochemical properties, as well as their solutions behavior. However, the preparation of well-defined miktoarm star polymers is a complex process, which requires the application of highly efficient synthetic methods, such as click chemistry and controlled polymerization techniques.

The present paper discusses a novel method for the synthesis of miktoarm star polymers with poly-2-alkyl-2-oxazoline and polyethylene glycol arms, as well as macrocyclic calix[8]arene core. The "grafting onto" scheme was used (Scheme 1). In the first step,  $\alpha$ -amino-functionalized polyethylene glycol chains were attached to the upper rim of calix[8]arene sulfonyl chloride derivative. At the second stage, acylhydrazide groups introduced into the lower rim of calix[8]arene were used to terminate living poly-2-alkyl-2-oxazoline chains obtained by cationic ring-opening polymerization.

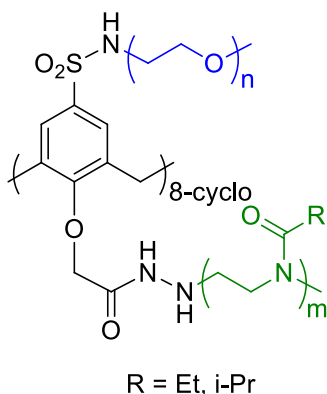

**Scheme 1.** Structure of miktoarm star polymers with a calix[8]arene core.

The synthesized samples of miktoarm star polymers were characterized by <sup>1</sup>H NMR spectroscopy, gel permeation chromatography and light scattering.

## Acknowledgements

This work was supported by the with the support of the grant of the President of the Russian Federation for young scientists and graduate students (project № SP-41 13.2022.4).

# POLYSACCHARIDE-BASED POLYELECTROLYTE COMPLEXES AS OPHTHALMIC DEXAMETHASONE DELIVERY SYSTEMS

*Bokatyi A.N.<sup>1</sup>, Dubashynskaya N.V.<sup>1</sup>, Skorik Y.A.<sup>1</sup>*

<sup>1</sup> Institute of Macromolecular Compounds of the Russian Academy of Sciences, St. Petersburg, Russia  
PhD student

[antoniobokatyi@gmail.com](mailto:antoniobokatyi@gmail.com)

The development of prolonged ocular dosage forms with anti-inflammatory activity is currently topical. The incorporation of drugs into nanoparticles of various types is one of the ways to improve the pharmaceutical properties of drugs (increase bioavailability, targeting of action, prolongation of action, reduction of degree and frequency of side effects). Polyelectrolyte complexes (PECs) as drug carriers are characterized by variability of properties (size, charge, pH or thermosensitivity) depending on the conditions of preparation (nature and molecular weight characteristics of polymers; concentrations, pH, order of mixing of polymer solutions). By varying the conditions of PEC preparation, it is possible to obtain nanoparticles with the required size, charge and drug release profile for different types of drug applications.

The aim of this study is to investigate the kinetics and dynamics of interpolymer complexation of PECs based on non-toxic and biocompatible water-soluble natural polysaccharides for the delivery of dexamethasone phosphate (DexP) for use in ophthalmology. As objects of study, we have chosen water-soluble cationic derivative of chitosan, namely diethylaminoethylchitosan (DEAECS), and polyanions – chondroitin sulfate (CHS), hyaluronic acid (HA) and dextran sulfate (DS). These are the most promising biopolymers for medical applications due to their high biodegradability and excellent biocompatibility; HA also has a high affinity for CD44 receptors and is the major component of the vitreous of the eye [1].

The solution of this problem will lead to (i) improved efficacy and safety of drug administration due to increased bioavailability and prolonged release, reduced dose and frequency of administration, which will reduce recovery time and cost of treatment, (ii) increased stability (and therefore shelf life) of drugs due to incorporation of active pharmaceutical molecules into PECs, (iii) development of a simple and convenient method of nanoparticle production for drug delivery characterized by high speed, good reproducibility, soft conditions and high quality of nanoparticles.

A series of polyelectrolyte complexes formed as a result of interpolymer interactions between HA polyanion and DEAECS polycation [2], CHS polyanion and DEAECS/CS polycations, and DS polyanion and DEAECS/CS polycations with simultaneous inclusion of zinc ions in the complex as a cross-linking agent were obtained. The developed PECs had hydrodynamic diameters ranging from 200 to 700 nm and had both positive and negative  $\zeta$ -potentials, which allowed them to be considered as different delivery systems. All particles had high encapsulation efficiency and high DexP content. The developed DexP delivery systems were characterized by both excellent mucoadhesion and prolonged drug release (for some systems about 70% of DexP was released within 10 h, for other systems about 60-70% of DexP was released within 14 days). In vitro experiments showed that encapsulation of DexP in polysaccharide nanocarriers did not reduce its anti-inflammatory activity compared to free DexP. Thus, polysaccharide-based dexamethasone delivery systems are promising for the development of anti-inflammatory dosage forms with improved pharmacological activity.

## References

- [1] *Carbohydrate Polymers*. **2024**, 122145
- [2] *Pharmaceutics* **2023**, 15(10), 2396

## Acknowledgements

This work was financially supported by the Russian Science Foundation (project No 23-23-00148).

# SYNTHESIS AND INVESTIGATION OF POLYMER HYDROGELS FILLED WITH CARBON QUANTUM DOTS

*Borodina A.M., Kostromin S.V., Bronnikov S.V.*

Russian Academy of Sciences, Institute of Macromolecular Compounds, St. Petersburg, Russia

Ph.D. Student

[Anastasi2998@gmail.com](mailto:Anastasi2998@gmail.com)

Hydrogels (HG) are an important class of materials with versatile properties. HG are hydrophilic bulk polymers obtained by crosslinking the monomer molecules. They contain a high amount of moisture, which makes them very soft and biocompatible. These properties allow HG to be used in biomedical, adsorption and electrochemical applications. However, traditional hydrogels do not have all the necessary properties. To expand the applications, additional components with attractive properties such as optical, electrical, magnetic and other properties, are introduced into hydrogels. The addition of nanoparticles gives hydrogels multifunctional properties. For example, fluorescent hydrogels have been obtained by introducing the organic dyes, lanthanides or semiconductor quantum dots into the hydrogel system. The emergence of carbon quantum dots (CQDs) has eliminated the disadvantages of traditional materials for photoluminescence (PL), such as poor photostability of organic dyes, high cost of lanthanides, and toxicity of semiconductor quantum dots [1].

CQDs are a new class of carbon-based nanomaterials with sizes less than 10 nm. Compared to other nanoparticles, CQDs have high photostability, low cost, good biocompatibility, high water solubility and tunable photoluminescence (PL). These properties give CQDs many potential applications in biomedicine, sensing, catalysis, optoelectronic devices and anti-counterfeiting. The disadvantages of CQDs include their tendency to aggregate in aqueous media, which causes a drastic decrease in PL intensity. The embedding of CQDs in hydrogels can't only solve the problem of their quenching effect, but also control the properties of hydrogels and even introduce some new properties [1].

In this work, we used CQDs obtained by citric acid pyrolysis [2]. The synthesised CQDs in the amount of 0.1 wt.% were used as fillers in polyacrylamide-based hydrogels (crosslinker - N,N'-methylenebisacrylamide). After injection into the hydrogel, the CQDs were evenly dispersed in the hydrogel volume and retained their photoluminescent properties (Fig. 1).

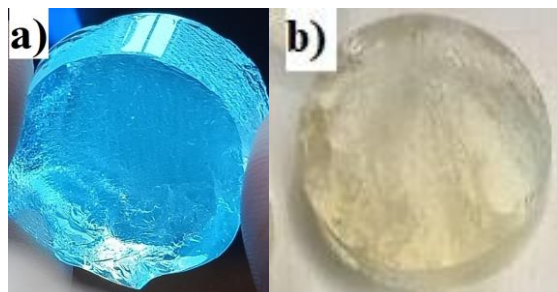

**Figure 1.** Digital images of HGCQDs (a) under UV irradiation ( $\lambda_{\text{ex}} = 365 \text{ nm}$ ) and (b) at daylight

The obtained nanocomposite hydrogels (HGCQDs) were used for detection of the  $\text{Fe}^{3+}$  ions in aqueous  $\text{FeCl}_3$  solutions. It was shown that an increase in the concentration of the  $\text{Fe}^{3+}$  ions leads to the weakening of the intensity (quenching) of PL of CQDs dispersed in the hydrogel. The investigated fluorescent hydrogels can be interesting as chemosensors for monitoring toxic metal ions in aqueous media.

## References

- [1] *Small*. **2023**, 19, 2207048
- [2] *Fuller. Nanotub. Carbon Nanostruct.*, **2023**, 31, 931-939.

# USE OF ZIRCONIUM-CONTAINING MIXED-LIGAND METAL-ORGANIC FRAMEWORKS IN SOLID-PHASE EXTRACTION OF ORGANIC DYES

*Bryantseva J.D.<sup>1</sup>, Uflyand I.E.<sup>1</sup>*

<sup>1</sup> Southern Federal University, Rostov-on-Don  
[bryanceva@sfedu.ru](mailto:bryanceva@sfedu.ru)

Metal-organic zirconium-based frameworks (Zr-MOFs) are known in analytical chemistry for their selectivity, productivity, cost-effectiveness, and regenerative capabilities. These stable structures interact strongly with contaminants due to Zr-OH groups, forming robust bonds with carboxyl groups. They effectively extract dyes, antibiotics, and heavy metal ions. However, they have low adsorption values and slow equilibrium times. The use of mixed ligands in the synthesis allows for incorporating two types of organic ligands with different structures and configurations, enhancing metal ion coordination and chelation efficiency.

This study aims to utilize a mixed-ligand Zr-MOF incorporating terephthalic acid and 1,10-phenanthroline for solid-phase extraction (SPE) of organic dyes. The sorbent was synthesized by the solvothermal method by reacting ZrCl<sub>4</sub>, terephthalic acid, and 1,10-phenanthroline in DMF. The proposed structure of the synthesized compound is depicted in Figure 1 and is based on both existing literature and our experimental data.

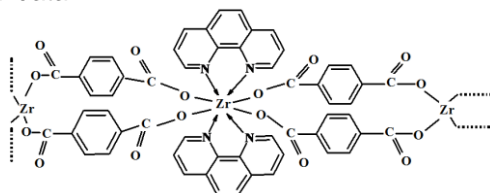

**Figure 1.** Structure of the compound synthesized by the solvothermal method

Nitrogen adsorption analysis revealed a mesoporous structure with a high surface area, typical of quality MOF material. The sample shows type II adsorption behavior, exhibiting a remarkable nitrogen adsorption capacity of 561 cm<sup>3</sup>/g at 77 K and a 9.6 Å pore size.

The ability of the sorbent to remove Congo red and methylene blue dyes from water was studied according to the method described in [1]. Factors such as pH, sorbent amount, and adsorption time were analyzed for their impact on removal efficiency. The sorbent initially shows rapid adsorption, reaching a maximum at 40 mg/g, and then decreases over time as adsorption moves from the surface to the pores. Higher temperatures accelerate adsorption equilibrium, allowing maximum removal within 20 minutes.

The sorbent emits blue luminescence under UV light upon Congo red extraction, indicating  $\pi$ - $\pi$  interaction with the dye. It works well at 35°C for Congo red, but better at 18°C for methylene blue. Despite the low initial adsorption activity, a significant decrease in dye concentration is observed over time with a 64.5-fold decrease in 15 minutes and 7500-fold decrease in 60 minutes at room temperature. The adsorption process follows a pseudo-first-order kinetic model based on regression analysis of experimental data.

To analyze the relationship between  $\ln K_D$  and  $1/T$ , graphs were constructed that determine the thermodynamic parameters of dye adsorption on the sorbent. The negative values of  $\Delta G^\circ$  at 283 K, 291 K, and 308 K indicate the spontaneous nature of the adsorption process. A decrease in  $\Delta G^\circ$  with increasing temperature suggests enhanced adsorption efficiency. Additionally, a positive  $\Delta S^\circ$  value suggests increased freedom at the solid-liquid interface during dye adsorption, indicating the sorbent's affinity for dye ions and potential structural changes in the adsorbent.

An important problem when using dyes in food products is the threat to human health due to the accumulation of dyes in food products [2]. Experiments were conducted to evaluate the sorbents effectiveness in removing artificial dyes from the low-alcohol drink like "Cherry" containing carmozine E122 dye and natural cherry juice. UV-visible absorption analysis confirmed the presence of the dye components in the drink.

## References

- [1] *Polymers*, **2020**, 12, 5, 1024
- [2] *Food Chemistry*, 254, **2018**, 241

## Acknowledgements

This work was supported by the Russian Science Foundation (project No 22-13-00260).

## MODIFICATION OF MOFS BY SPIROPYRAN MOLECULES

*Burachevskaja O.A.*<sup>1</sup>, *Butova V.V.*<sup>2</sup>, *Ozhogin I.V.*<sup>3</sup>, *Pugachev A.D.*<sup>3</sup>, *Starikov A.S.*<sup>3</sup>, *Tereshchenko A.A.*<sup>1</sup>, *Borodkin G.S.*<sup>3</sup>

<sup>1</sup>The Smart Materials Research Institute, Southern Federal University, Ros-tov-on-Don, Russia

<sup>2</sup>Institute of General and Inorganic Chemistry, Bulgarian Academy of Sciences, Sofia, Bulgaria

<sup>3</sup>Institute of Physical and Organic Chemistry, Southern Federal University, Rostov-on-Don, Russia  
PhD student

[oburachevskaya@sfedu.ru](mailto:oburachevskaya@sfedu.ru)

Metal-organic frameworks (MOF) are a class of porous materials that includes two structural units: a metal cluster (secondary building unit) and an organic molecule (linker) [1]. Due to the possibility to adjust the properties for a specific task, these materials have great potential for applications in various fields [2-4]. One of the representatives of this class of materials are metal-organic frameworks of the UiO-66 family. Their structure includes zirconium-oxygen clusters connected by various linkers. Functional groups within linkers play the role of active centers for further modification.

This work presents a study aimed at introducing photoactive spiropyran molecules into the UiO-66-NH<sub>2</sub> framework. Two types of spiropyrans were used for this purpose - one with an aldehyde group, and the other with both an aldehyde and a carboxylic group. In the first case, the aldehyde group demonstrated the potential for the formation of C–N bonds with amino groups of linkers. In another case, spiropyran molecules with carboxylic groups demonstrated the ability to coordinate zirconium in defect pores of UiO-66-NH<sub>2</sub>.

To confirm the formation of the C–N bond in the composition of the metal-organic framework, a complex salt of spiropyran and individual linkers (aminoterephthalate) was synthesized. The DFT calculations confirm our conclusions. FTIR measurements have shown that the introduction of a photoactive fragment leads to photoresponse of the UiO-66-NH<sub>2</sub> framework. Powder X-ray diffraction data show that the obtained materials retain high crystallinity, demonstrating the isostructural characteristics of the UiO-66 framework. The measured nitrogen adsorption isotherms were classified as type I in accordance with IUPAC recommendations typical for microporous materials. TEM images have shown that all the obtained materials have typical well-crystallized octahedral crystals of the order of 70 nm in size.

Experimental and calculated data have shown that both ways of including photoactive elements are viable in the process of functionalization. Thus, the studied mechanisms are promising for the synthesis of smart materials combining the porous structure of metal-organic frameworks and photosensitive elements of spiropyran molecules.

### References

- [1] *Russ. Chem. Rev.* **2016**, 85, 280-307
- [2] *Proceedings of the J. Mater. Chem.* **2006**, 626-636
- [3] *Energy Environ. Sci.* **2015**, 8, 1837-1866
- [4] *J. Am. Chem. Soc.* **2005**, 127, 17998-17999

### Acknowledgements

The research was supported by the Strategic Academic Leadership Program of the Southern Federal University ("Priority 2030").

## NOVEL THIN FILM COMPOSITE NANOFILTRATION MEMBRANES WITH POLYANILINE INTERMEDIATE LAYER

*Burts K.S.<sup>1</sup>, Plisko T.V.<sup>1</sup>, Penkova A.V.<sup>1</sup>, Bilyukevich A.V.<sup>2</sup>*

<sup>1</sup> St. Petersburg State University, 7/9 Universitetskaya nab., 199034, St. Petersburg, Russia

<sup>2</sup> Institute of Physical Organic Chemistry, National Academy of Sciences of Belarus, 220072 Minsk, Belarus

Researcher

[e.burt@spbu.ru](mailto:e.burt@spbu.ru)

The novel thin film composite polyamide/polysulfone (PSU) nanofiltration (NF) membranes with intermediate layer of polyaniline (PANI) were obtained. An intermediate PANI layer of composite NF membranes was formed during the oxidative polymerization of aniline on the surface of the substrate membrane at a low temperature (4-10°C) by physical adsorption from an aniline solution in 1M HCl in the presence of ammonium persulfate initiator (NH<sub>4</sub>)<sub>2</sub>S<sub>2</sub>O<sub>8</sub>. The formation of the polyamide (PA) layer was carried out by the interfacial polymerization (IP) technique during the reaction between aqueous solution of piperazine (PIP) and a solution of trimesoyl chloride (TMC) in organic solvent Nefras C2.

It was found that formation of an PANI intermediate layer from a 0.1% aniline solution for 0.5 h on the porous PSU ultrafiltration membrane-support led to a decrease in the pore size of the selective layer and an increase in the degree of surface roughness. It was revealed that the formation of an intermediate layer based on PANI resulted in a significant increase in the permeability of composite NF membranes with polyamide (PA) selective layer from 21 to 45-47 L·m<sup>-1</sup>·h<sup>-1</sup> (at ΔP=5 bar).

It was shown that increase in time of the PANI layer formation from 0.5 h to 1 h yielded the looser PA layer organization due to the decrease in the rejection coefficient (R) for MgSO<sub>4</sub> from 99.99% to 93% for membranes with PANI intermediate layers applied for 0.5 and 1 h, respectively. Moreover, rise in the formation time of PANI resulted in the increase in R for NaCl.

The effect of the concentration of reagents in the IP reaction during the formation of a selective PA layer on the structure and transport properties of NF membranes with an intermediate layer obtained by oxidative polymerization of a 0.1% aniline solution for 0.5 h was studied. It was found that an increase in the concentration of reagents in the IP reaction led to a monotonic decrease in J of membranes from 64 L·m<sup>-1</sup>·h<sup>-1</sup> (at ΔP=5 bar) for a membrane with PA layer obtained by the reaction of 1% PIP and 0.06% TMC, down to 45 L·m<sup>-1</sup>·h<sup>-1</sup> in the case of NF membrane obtained by the reaction of 4% PIP and 0.24% TMC. The decrease in permeability was likely due to the formation of a thicker selective PA layer.

It was shown that R for MgSO<sub>4</sub> did not change with varying composition of the PA layer and was 99.99%. An increase in the concentration of PIP and TMC yielded in slight change in the rejection of Na<sub>2</sub>SO<sub>4</sub> (69-76%), while the rejection coefficient of MgCl<sub>2</sub>, CaCl<sub>2</sub>, LiCl and the antibiotic sulfadimethoxine (M = 310.3 g·mol<sup>-1</sup>) increased from 74 to 93%, from 45 to 92%, from 4 to 25% and from 69 to 96%, respectively. However, increasing the concentration of monomers in the interfacial polymerization reaction causes a significant decrease in NaCl retention from 65 to 5%.

The effect of the aniline concentration used to form the intermediate layer on the transport properties of NF membranes was studied. It was found that the formation of an PANI intermediate layer from a solution with a monomer concentration of 0.5% followed by application of a PA layer at a reagent concentration of 2% PIP and 0.12% TMC led to the preparation of an impermeable NF membrane at ΔP=5 atm. It was shown that the permeability of NF membranes passes through a maximum with increasing aniline concentration from 0.05 to 0.3% and reaches 64 L·m<sup>-1</sup>·h<sup>-1</sup> at an aniline concentration of 0.1% and PA layer prepared from 2% PIP and 0.12% TMC solutions. The rejection coefficient for MgSO<sub>4</sub> had a maximum value at an aniline concentration of 0.1% and was 99.99%, while at the aniline concentration of 0.05 and 0.3% R(MgSO<sub>4</sub>) had lower values of 93 and 71%, respectively. The rejection coefficients for Na<sub>2</sub>SO<sub>4</sub> and MgCl<sub>2</sub> decreased monotonically from 84% to 53% and from 96% to 73%, respectively with increasing aniline concentration. It was revealed that R for CaCl<sub>2</sub> passes through a minimum at an aniline concentration of 0.1% and lied within the range of 59-78%. R for NaCl and LiCl increased from 10 to 47% and from 5 to 22%, respectively, with increase in aniline concentration. The R for sulfadimethoxine did not significantly change with an increase in aniline concentration and was in the range of 78-80%. It should be noted that NF membranes with intermediate layer obtained from 0.1% aniline solution characterized by a higher water permeability (64 L·m<sup>-1</sup>·h<sup>-1</sup>, ΔP=5 atm) and R for magnesium sulfate (99.99%) compared to the NF membrane without intermediate layer (53 L·m<sup>-1</sup>·h<sup>-1</sup>, ΔP=5 atm, 82%, respectively).

### **Acknowledgements**

This work was supported by the Russian Science Foundation (project No 22-73-10034).

# DEVELOPMENT AND STUDY OF PHYSICOCHEMICAL PROPERTIES OF PH-SENSITIVE DELIVERY SYSTEMS OF ENCAPSULATED BSA BASED ON CHITOSAN AND HYDROXYAPATITE

*Chernikova E.E.<sup>1</sup>, Zagvozhkin M.D.<sup>1</sup>, Brussevich A.<sup>2</sup>*

<sup>1</sup> Tomsk State University, Department of Chemistry, Tomsk, Russia

<sup>2</sup> ITMO University, Infochemistry Scientific Center, St. Petersburg, Russia

Student, Master's degree

[abby.wade@mail.ru](mailto:abby.wade@mail.ru)

In recent years, the development of new drugs and systems has been a major biomedical challenge. Differences between the extracellular and intracellular environments of pathologic and normal cells in pH make it possible to obtain and study materials for controlled drug release that respond to changes in the environment [1]. The most suitable in terms of physical, chemical and biological properties for the design of the materials is chitosan, which is often used as a delivery system for nucleic acids, various drugs or active substances due to its biocompatibility [2].

In the process of synthesis we used: low molecular weight chitosan ( $[(C_{12}H_{22}O_8N_2)_n]$ ),  $CaCl_2$ ,  $Na_2HPO_4 \cdot 12H_2O$ , bovine serum albumin (BSA) solution, NaOH, terephthalic aldehyde ( $C_8H_6O_2$ ), distilled water.

First, a 10% wt solution of  $Na_2HPO_4 \cdot 12H_2O$  and 0.5% wt solution of chitosan in 0.5% wt aqueous acetic acid solution were prepared. Then 7.5% wt aqueous solution of BSA was added to the chitosan solution, and then afterwards this mixture was slowly dropped into the  $Na_2HPO_4 \cdot 12H_2O$  solution through a separating funnel under constant stirring. After mixing, the prepared solution was increased to pH=10 with aqueous NaOH solution and stirred for 20 minutes on a magnetic stirrer. For crosslinking, an aqueous solution of terephthalic aldehyde with a concentration of 2.5 mg/mL was prepared by heating and constant stirring, then added to the alkalized chitosan solution, and the final solution was stirred for 1 hour at 50°C. The colloidal mixture was washed 4 times with distilled water and filtered on a vacuum unit. To precipitate hydroxyapatite (HA) on the surface, the particles were soaked in  $CaCl_2$  and  $Na_2HPO_4$  solutions for 10 minutes, respectively, and the cycle was performed twice.

The surface morphology of the obtained materials was investigated on a HITACHI TM-3000 electron microscope at an accelerating voltage of 5 kV for all samples, in the low vacuum mode. The obtained images are presented in Scheme 1.

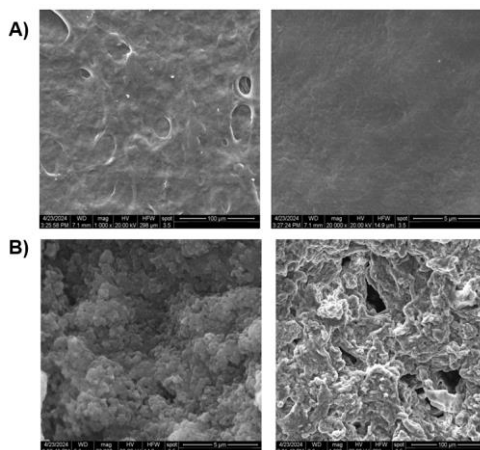

**Scheme 1.** SEM images of the obtained chitosan particles with encapsulated BSA. A) materials without HA deposition on the surface B) materials with deposited HA on the surface.

In this research, chitosan particles with BSA encapsulated as well as HA deposited on the surface were obtained. By comparing the SEM images, a transition from a film-like surface structure to a polycrystalline one with a monomodal distribution of particle fractions in the range from 322 to 635 nm is obvious on the surface.

## References

- [1] *Smart micro/nanoparticles in stimulus-responsive drug/gene delivery systems* / M. Karimi, A. Ghasemi, P. Sahandi Zangabad, R. Rahighi [et al] // *Chem Soc Rev*, **2016**. – V. 45. – P. 1457–1501.
- [2] *Kamskaya V.E. Chitosan: STRUCTURE, PROPERTIES AND USE // BIOLOGICAL SCIENCES [in Russ]*. – **2016**. – T. 6. – C. 36–42.



## SOLID-PHASE EXTRACTION OF PERSONAL CARE PRODUCTS USING NICKEL TEREPHTHALATE COMPLEX WITH 2,2'-BIPYRIDINE

*Chernomorova M.A.<sup>1</sup>, Uflyand I.E.<sup>1</sup>, Zhinzhiro V.A.<sup>1</sup>*

<sup>1</sup> Southern Federal University, Rostov-on-Don, Russia

Graduate student

[chernomorova.m@mail.ru](mailto:chernomorova.m@mail.ru)

Environmental pollution is increasing worldwide due to population growth and industrial development. Some of the pollutants are personal care products found in surface and groundwater. Many of them can be harmful to human health due to potential carcinogenicity and toxicity. Among them, diclofenac sodium is a common non-steroidal anti-inflammatory drug, and chlorhexidine bigluconate is a widely used antiseptic. Most previously known water purification technologies are expensive and produce toxic by-products. Solid phase extraction technology as an effective water purification strategy has been used due to its low cost, ease of operation, and generation of few by-products [1, 2].

The purpose of this work was to study the nickel terephthalate-2,2'-bipyridyl complex for solid-phase extraction of diclofenac sodium and chlorhexidine bigluconate from an aqueous solution. To achieve this goal, the following tasks were set: to test the adsorption potential of the metal-organic framework (MOF), to study the influence of various variables, such as the initial concentration of the test objects, temperature, pH and contact time.

As a result of model experiments, it was found that the nickel terephthalate complex with 2,2'-bipyridyl has good sorption properties with respect to the studied substances. Adsorption decreases with decreasing initial concentration and increasing temperature. The regularities of the process of solid-phase extraction of personal care products using MOF were established using the Langmuir and Freundlich models. Analysis of Langmuir adsorption isotherms shows that the correlation coefficient is in the range from 0.8 to 0.98, which allows us to apply this model to describe solid-phase extraction under our conditions. The analysis of Freundlich adsorption isotherms shows that the experimental data obtained are in satisfactory agreement with this model, since the correlation coefficient is quite high. To determine the possibility of the spontaneous adsorption process and verify the experimental data obtained, three main thermodynamic parameters were used: changes in enthalpy ( $\Delta H^0$ ), entropy ( $\Delta S^0$ ) and Gibbs free energy ( $\Delta G^0$ ). Negative  $\Delta G^0$  values indicate a spontaneous adsorption process. Negative  $\Delta H^0$  values confirm the exothermic nature of the adsorption process. A positive entropy value indicates an increase in the number of degrees of freedom at the solid-liquid interface during the adsorption of the studied objects and reflects the affinity of the sorbate for the sorbent surface. Kinetic models of pseudo-first and pseudo-second order reactions were used to analyze the data obtained during the study of the adsorption process. The pseudo-first order equation satisfactorily describes the patterns of adsorption at the initial stages of the process. Analyzing the dependence of the degree of adsorption on the pH of the medium, it can be concluded that the degree of adsorption is higher in neutral and alkaline media and lower in acidic media. In alkaline media, adsorption is satisfactory.

Regeneration is an important aspect of the use of adsorbents. Solvent washing using 2-propanol, dimethyl ketone, and an alkaline ethanol solution can be used to effectively regenerate MOFs. It was experimentally established that 92.7% of chlorhexidine bigluconate and 96.5% of diclofenac sodium were obtained by elution.

It can be concluded that MOF with a mixed ligand based on nickel terephthalate and 2,2'-bipyridine is an effective adsorbent for removing personal care products (diclofenac sodium and chlorhexidine bigluconate) from aqueous media. The maximum adsorption value is 153.6 mg/g for chlorhexidine bigluconate and 284.8 mg/g for diclofenac sodium.

### References

- [1] *Environ. Manage.* **2016**, 182, 620
- [2] *Hazard. Mater.* **2012**, 233–234, 89

### Acknowledgements

This work was supported by the Russian Science Foundation (project No 22-13-00260).

# DETERMINATION OF PARTITION COEFFICIENTS OF LIPOPHILIC ELECTROLYTES BETWEEN WATER AND PLASTICIZED POLYVINYLCHLORIDE MEMBRANE

*Chetverikova D.A., Pokhvishcheva N.V., Peshkova M.A.*

St. Petersburg State University, St. Petersburg, Russia

Student

[d4verikova@gmail.com](mailto:d4verikova@gmail.com)

Single ion partition coefficients are a function of standard Gibbs energy of transfer from one phase to another. They describe the ion affinity towards one of the phases under consideration. Partition coefficients between water and plasticized polyvinylchloride membranes are widely used for theoretical description of optode and ion-selective electrode response. Moderately lipophilic electrolytes can be added into these sensors in order to stabilize the interfacial potential. This enables to create solid contact reference electrodes and optical sensors, responding to a single ion activity [1]. Knowledge of partition coefficients allows configuring analytical characteristics of optodes and helps to create sensors with required dynamic range and lifetime. However, there is few data on lipophilic organic electrolytes partition between water and plasticized polyvinylchloride membranes in the literature.

The main approaches proposed for determination of the partition coefficients are based on voltammetric and potentiometric measurements as well as on solubility measurements and distribution of substance between phases. This research deals with the latter. Plasticized polyvinylchloride membranes were brought into contact with an aqueous phase. Equilibrium concentrations of the examined compounds were measured using spectrophotometry in ultraviolet and visible regions.

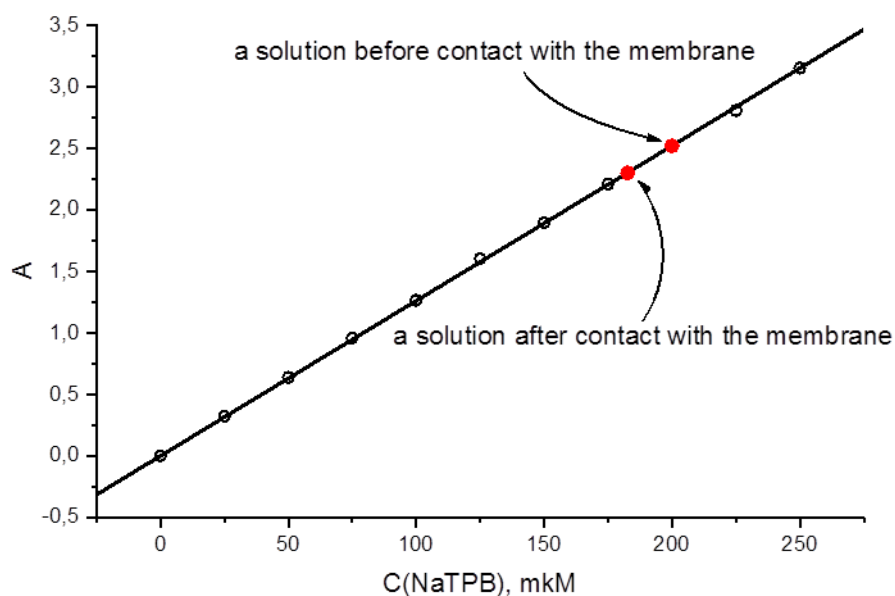

**Figure 1.** Distribution of sodium tetraphenylborate (NaTPB) between phases.

Obtained values of the partition coefficients are close to those presented in the literature for membranes with a different plasticizer [2]. In particular, for the tetraphenylborate ion is  $\lg k = 5.03 \pm 0.10$ , which is close to  $\lg k = 5.37$  determined for a similar system. For the cetyltrimethylammonium cation  $\lg k = 5.20 \pm 0.26$  and for the tetrahexylammonium ion  $\lg k = 3.49 \pm 0.13$ .

## References

- [1] *ACS Sensors*, **2023**, 8, 3086.
- [2] *Membranes*, **2022**, 12, 1019

## Acknowledgements

This work was supported by the Russian Science Foundation (project 20-73-10033)

# COMB-LIKE POLYELECTROLYTES BASED ON LOW MOLECULAR WEIGHT BLOCK COPOLYMER OF THE SURFACTANTS AND PEG-ACRYLATE FOR MICELLAR CATALYSIS

*Danilova E.E.<sup>1</sup>, Fetin P.A.<sup>1</sup>, Zorin I.M.<sup>1</sup>*

<sup>1</sup>St. Petersburg State University, St. Petersburg, Russia

Student, Bachelor

[st051927@student.spbu.ru](mailto:st051927@student.spbu.ru)

The processes of self-assembly of matter into more highly ordered structures manifest themselves in many areas of life. Studying these processes opens up the possibility of managing them and, as a result, applying the acquired knowledge in practice. One of the well-known examples of self-assembly in chemistry is the process of micellization, which is based on the spontaneous association of amphiphilic molecules, so-called surfactants, in water. They are used everywhere, but thanks to a detailed study of their properties, it has become possible to use them as nanoreactors, which make it possible to transfer many organic reactions into the aqueous phase due to the ability of the non-polar fragment of the surfactant molecule to dissolve organic substances, increasing the degree of conversion and significantly accelerating them.

The main parameters of the resulting micellar systems are the solubilization capacity of the aggregates and their ability to undergo ionic interactions. The evolution of surfactant catalytic systems has led to the use of comb-like polyelectrolytes, which are the polymerization product of the surfactants. These polymers were selected due to their increased solubilization capacity, low critical micelle concentration, and wide variability in functional substitution [1].

In this work, it is proposed to use comb-like polyelectrolytes based on 11-(acryloyloxy)-undecyltriethylammonium bromide (AUTEA-B) and its comonomer 2-(2-ethoxyethoxy)ethyl acrylate (Scheme 1). It has been noted that the latter, being a hydrophilic surfactant, can significantly increase the solubilization capacity of the micelle and accelerate the model reaction of alkaline hydrolysis of para-nitrophenylacetate.

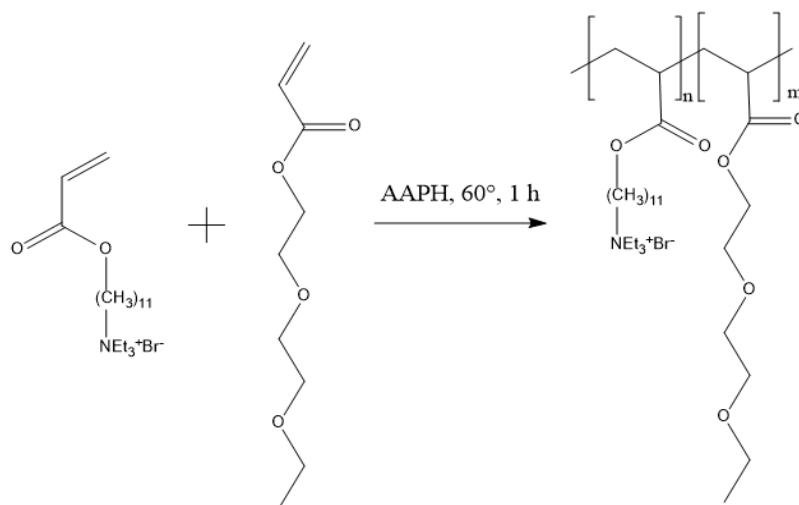

**Scheme 1.** Polymerization reaction of AUTEA-B and 2-(2-ethoxyethoxy)ethyl acrylate.

In a micellar medium, almost all types of reactions are effectively reconstructed, such as: hydroformylation, Diels-Alder reaction, redox transformation, coupling reactions, regio- and stereoselective reactions, etc. [2]. In the future, it is planned to study the catalytic activity of copolymers AUTEA-Br and 2-(2-ethoxyethoxy)ethyl acrylate in cross-coupling reactions.

## References

- [1] *Macromolecules* **2016**, 49.13, 4714-4722.
- [2] *Journal of Molecular Liquids* **2020**, 321, 114897.

## Acknowledgements

This work was supported by a grant of the Ministry of Science and Higher Education of the Russian Federation for large scientific project in priority areas of scientific and technological development (grant number 075-15-2024-553)

## DEVELOPMENT AND STUDY OF CARRAGEENAN/STARCH/NANOCELLULOSE FILMS FOR ADVANCED EDIBLE PACKAGING MATERIAL

*Dmitrenko M.E.<sup>1</sup>, Kuzminova A.I.<sup>1</sup>, Pasquini D.<sup>2</sup>, Penkova A.V.<sup>1</sup>*

<sup>1</sup> St. Petersburg State University, St. Petersburg, Russia

<sup>2</sup> Universidade Federal de Uberlândia University, Uberlandia, Brazil

PhD., Associate professor

[m.dmitrienko@spbu.ru](mailto:m.dmitrienko@spbu.ru)

Growth in population and food production demands leads to the development of novel packaging materials. Various materials such as plastic, paper, metal, glass, etc. are used for packaging. The most widely used disposable packaging materials are non-biodegradable plastics, which results in the generation of millions of tons of waste that is harmful to the environment and human health. Therefore, the food industry is looking to replace non-biodegradable plastics with eco-friendly and biodegradable ones that are useful in extending the shelf life of food products, improving their quality and minimizing harm to the environment and human health. Edible films based on lipids, proteins, polysaccharides and their composites can be alternative to plastic substitutes for food packaging. However, their physicochemical and mechanical properties still have limitations, which require further improvement.

In the present work, films from carrageenan/starch/nanocellulose were developed and investigated for the promising application as edible food packaging materials. To enhance the mechanical properties of films, nanocellulose was incorporated into the carrageenan/starch matrix. Other plasticizers such as glycerin, myristic acid, sesame oil, and aloe vera gel were also used to improve film moisture resistance and flexibility and provide antibacterial properties. The structure and physicochemical properties of developed films were characterized by various methods of FTIR spectroscopy, scanning electron microscopy, thermogravimetric analysis, measurements of contact angles and other parameters (solubility, permeability, moisture absorption, etc.). By perspective using the developed carrageenan/starch/nanocellulose films for food packaging, the environmental, economic and social aspects of food storage may be improved.

### **Acknowledgements**

The study was carried out with the financial support of the Russian Federation represented by the Ministry of Science and Higher Education, grant number 075-15-2022-1231 on 18 October 2022; and Brazilian National Council for Scientific and Technological Development (CNPq), grant number 440057/2022-1. The experimental work was facilitated by the equipment from the Resource Centers for Nanotechnology, Magnetic Resonance, Thermogravimetric and Calorimetric Research Centre, the Centre for Innovative Technologies of Composite Nanomaterials, Chemical Analysis and Materials Research Centre, and the Centre for "Nanofabrication of Photoactive Materials (Nanophotonics)" at the St. Petersburg State University.

# INVESTIGATION OF INFLUENCE OF THE ELECTROLYTE NATURE AND COMPOSITION ON THE ELECTROCATALYTIC ACTIVITY OF POLY(TEMPO-PYRROLE)

*Dolmatova A.G.<sup>1</sup>, Levin O.V.<sup>1</sup>*

<sup>1</sup> St. Petersburg State University, St. Petersburg, Russia  
Student  
[st097759@spbu.ru](mailto:st097759@spbu.ru)

The electrocatalytic properties of polypyrrole modified by 2,2,6,6-tetramethylpiperidin-1-oxyl (TEMPO) were investigated in this work as an example of anodic oxidation of alcohols. The principal convenience of such a system is the possibility of electrochemical regeneration of the oxidizing agent, oxoammonium ion, with its further chemical reduction to hydroxylamine.

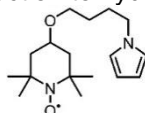

**Scheme 1.** Chemical structure of TEMPO-pyrrole

In the course of this work, it was found that in aqueous buffer media, the electrochemical response of the TEMPO group strongly depends on the electrolyte composition. This effect was studied by taking CVA from a poly-TEMPO-pyrrole modified electrode using methanol and glucose as model substrates. The concentrations of the oxidizable substrates, pH, and electrolyte composition were varied during the experiment, including the addition of various extraneous ions, such as the single-charged lithium perchlorate ion.

The presence of alcohol significantly affects the electrochemical response from the TEMPO group. It can be seen from the CVA readings that as the alcohol concentration increases, the oxidation current increases and the shape of the anodic peak changes significantly, becoming similar to a "wave". At the same time, the cathodic peak becomes less pronounced and the reduction current decreases in modulus. However, in the presence of a single-charged ion, this effect disappears.

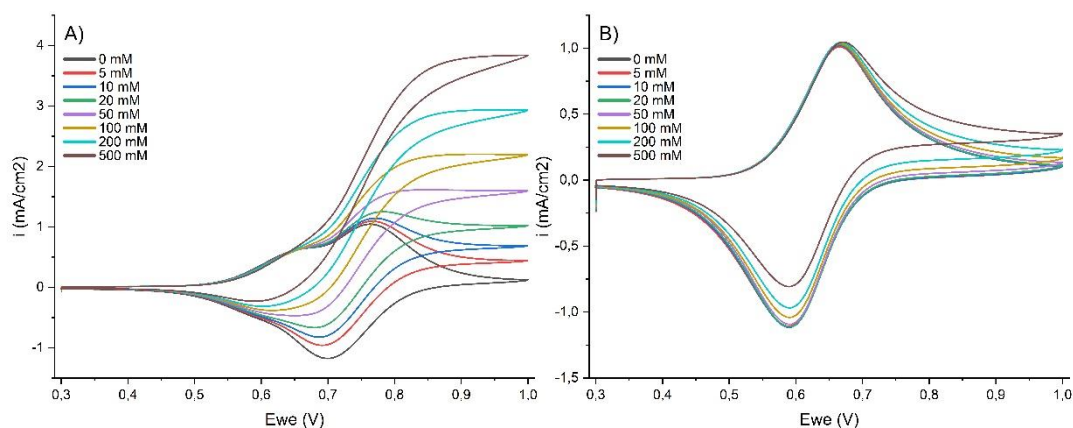

**Scheme 2.** CVA of poly-TEMPO-pyrrole at different glucose concentrations in the electrolyte composition: 200 mM phosphate buffer, pH = 7.4 (A), 100 mM NaClO<sub>4</sub>, 100 mM phosphate buffer, pH = 7.4 (B). Sweep speed 50 mV/s

## References

- [1] *Chemelectrochem.* **2014**, 1, 455-462
- [2] *Electroanalysis.* **2018**, 30, 24
- [3] *Nat. Chem.* **2024**

# SYNTHESIS AND CHARACTERISATION OF THE FUNCTIONAL PROPERTIES OF STARCH CITRATES BASED ON THERMALLY TREATED CORN STARCHES

*Dogadina A. A., Maslennikov D. V.*

Novosibirsk State University, Faculty of Natural Sciences  
Solid State Chemistry and Mechanochemistry of the Siberian Branch of the Russian Academy  
of Sciences Novosibirsk, Russia

Student

[anna.dogadina16@gmail.com](mailto:anna.dogadina16@gmail.com)

Starch is a common macromolecular complex consisting of amylose and amylopectin. Starch is widely used in various areas of human life, such as food industry, pharmaceuticals, textile industry, etc. However, a number of disadvantages of native starch limits its application. It is possible to eliminate these disadvantages by means of modifications. Chemical modifications include the grafting, phosphorylation, the formation ethers and esters and cross-linking [1].

This work is devoted to one of the types of chemical modification of starch - the reaction of esterification with citric acid. The aim of the work is to synthesize and study the functional properties of starch citrates based on thermally treated starches. Since citric acid is a tricarboxylic acid and has the ability to form a cyclic anhydride, in addition to the formation of monoester bonds with anhydroglucose, it can act as a bridge molecule between polymer chains (Figure 1).

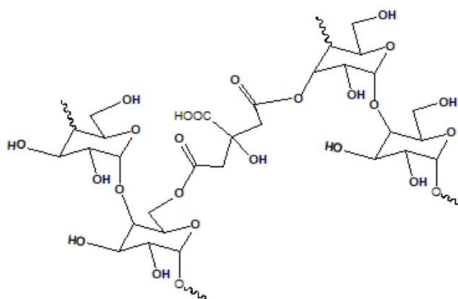

**Figure 1.** Citric acid bridge molecule linking starch polymer chains

Starch citrates were synthesized by a dry method, which involves holding a starch sample with sorbed citric acid at 140°C for 5 hours. The precursors for obtaining samples were native corn starch and starches that have undergone thermal pretreatment by the DHT ("dry heat treatment") [2] and SSP ("shells separation pretreatment") [3] methods. DHT involves holding dry starch at temperatures above 100°C for several hours. SSP is a relatively new specific thermal treatment method in which short-term exposure to specified temperatures of a low-concentration starch suspension results in the separation of starch granule shells.

XRD-analysis has shown that starches after etherification irreversibly lose their crystalline structure. The samples showed an increased ability to absorb water compared to native starch. Also, the stability of starch citrates to the action of amylolytic enzymes reaches from 38% to 60%. It is noteworthy that the obtained samples, having practically the same degrees of substitution (about 0.3), have different properties.

## References

- [1] *Polymers. Multidisciplinary Digital Publishing Institute (MDPI)*. **2023**, 15, 16
- [2] *Int. J. Biol. Macromol.* **2020**, 147, 109–116
- [3] *Int. J. Biol. Macromol.* **2020**, 164, 242–252

## Acknowledgments

The authors express their gratitude to graduate students Denis Tryakhov and Anna Voroshnina, as well as research staff of the laboratory of mechanochemistry ISSCM SB RAS

DEVELOPMENT AND RESEARCH ON COMPOSITE MEMBRANES BASED ON  
CARBOXYMETHYLCELLULOSE FOR THE HYBRID PROCESS "ESTERIFICATION +  
PERVAPORATION"

*Dubovenko R.R., Dmitrenko M.E., Kuzminova A.I., Mikulan A.I., Puzikova M.E., Selyutin A.A.,  
Penkova A.V.*

St. Petersburg State University, St. Petersburg, Russia  
Postgraduate  
r.dubovenko@spbu.ru

Membrane technologies have emerged as a rapidly growing and highly promising field in modern science and industry. These technologies encompass a wide range of applications, from water purification and desalination to gas separation, biotechnology, and energy production. The development and advancement of membrane technologies hold immense potential for addressing crucial issues such as access to clean water, efficient resource utilization, and environmental sustainability.

The creation of membranes for membrane reactors is particularly significant in the context of chemical processes and energy production. Membrane reactors combine the principles of membrane separation and chemical reactions, enabling efficient and selective separation of products while simultaneously facilitating the reaction process. These advanced systems offer numerous advantages, including enhanced conversion rates, improved product purity, and reduced energy consumption. By integrating membrane separation and chemical reactions into a single unit, membrane reactors eliminate the need for traditional separation processes, resulting in more compact and energy-efficient operations. Furthermore, the development of membranes with specific permeabilities and selectivities can drive the reaction equilibrium towards desired products, enabling the production of high-value chemicals and fuels in a more profitable manner.

In recent years, the incorporation of advanced nanomaterials, such as metal-organic frameworks (MOFs), into polymer membranes has emerged as a promising approach to enhance membrane performance. MOFs are crystalline porous materials with exceptionally high surface areas, tunable pore sizes, and unique adsorption properties, offering new opportunities for membrane design. By incorporating MOFs into polymer matrices, researchers aim to create composite membranes with enhanced permeability, selectivity, and stability, unlocking new possibilities for various separation and reaction processes.

The integration of Zn-based MOFs, porous modifiers, into the polymer matrix has led to enhanced transport performance. To comprehensively analyze the developed composite membranes, a multitude of characterization techniques were utilized, including Fourier-transform infrared spectroscopy (FTIR), thermogravimetric analysis (TGA), nuclear magnetic resonance (NMR), scanning electron microscopy (SEM), atomic force microscopy (AFM), and quantum chemical calculations. The hydrophilic-hydrophobic properties of the membrane surface were evaluated by measuring water contact angles using the sessile drop method. It was shown that improved transport performance can be ascribed to the modification of the hydrophilic-hydrophobic balance of the membrane surface and the creation of additional free volume between polymer chains. Furthermore, the influence of the modifying additive on the transport properties of the membranes was investigated through a hybrid process involving esterification reaction and pervaporation for the synthesis of ethyl acetate.

#### **Acknowledgements**

This work was supported by the Russian Science Foundation grant № 20-79-10064, <https://rscf.ru/project/20-79-10064/>. The experimental work was facilitated by the equipment from the Resource Centers for Nanotechnology, Magnetic Resonance, Cryogenic Department, Thermogravimetric and Calorimetric Research Centre, Centre for Physical Methods of Surface Investigation, Centre for Innovative Technologies of Composite Nanomaterials, Computing Centre, Chemical Analysis and Materials Research Centre, and Centre "Nanofabrication of Photoactive Materials (Nanophotonics)" at the St. Petersburg State University.

## HIGHLY FILLED ALUMINUM-BASED COMPOSITE MATERIALS IN POWDER INJECTION MOLDING AND IN FUSED FILAMENT FABRICATION

*Dudka D.V.<sup>1</sup>, Mityukov A.V.<sup>1</sup>, Malkin A. Ya<sup>1</sup>.*

<sup>1</sup> A.V. Topchiev Institute of Petrochemical Synthesis, Russian Academy of Sciences. Russia 119991, Moscow. 29. Leninsky prospect  
Postgraduate  
[dudka@ips.ac.ru](mailto:dudka@ips.ac.ru)

Progress in ceramic powder injection molding in past few years have led to increased interest in this method in various industries. Powder injection molding (PIM) overcomes limitations of injection molding and traditional powder compacts including productivity limits, drastically decreasing amounts of defects and improves mechanical strength. Due to the demand in high performance materials and minimization of complex components in production, PIM market has doubled its size in the past decade.

Our main goal was to investigate the properties and behavior of powder injection molded samples and decide if it is reasonable to use them for this technique. For this study, three compositions were prepared, each containing 75 wt.% aluminum oxide and 25 wt.% binder. The rheological properties of the compositions were analyzed using a rotational rheometer. Mechanical properties were tested using standard method for compressive strength determination. A filament with a standard diameter was obtained using a single-screw extruder. The testing samples were printed using the FFF method, followed by debinding and sintering. Cylindrical objects were printed and tested to determine their compressive strength. We have compared mechanical properties of FFF-printed samples with those, produced using classical methods. It appears that classical methods are still superior to the additive technologies in terms of mechanical strength but there is a growing body of research indicating that additive manufacturing techniques have great potential in certain applications and it is possible to enhance properties of products made with them. Moreover, it is extremely difficult or nearly impossible to use suspensions with a filler concentration exceeding 50 wt.% as a filament for 3D-printing as they do not tend to melt and/or flow. Furthermore, there is no point in using materials with concentrations of 50 wt.% or less, as their mechanical properties are considerably lower than those of powder injection molded materials.

The study demonstrated possibility of printing high-quality items with different types of geometries. The research suggests an idea of integrating PIM into the reforging of high-temperature polymers via FFF-technology. This choice is due to the fact that there is a number of polymers, the processing of which by traditional methods is difficult or practically impossible. First of all, we are talking about high-melting polymers, such as Polytetrafluoroethylene (PTFE), Polyether ether ketone (PEEK), Ultra-High Molecular Weight Polyethylene (UHMWPE), which have melting points much higher than 300-400°C, or do not melt at all and decompose when reaching these temperatures (UHMWPE for instance). At the stage of practical realization of the work it was possible to show the principal possibility of using powders of refractory or non-melting polymers in powder injection molding as a new way of their processing into products. The main idea is to unify PIM and Fused Filament Fabrication (FFF) methods and establish a hybrid technique possessing advantages of both technologies. Implementing PIM principles to FFF-technology allows the achievement of customized material characteristics, such as complex geometries, improved mechanical strength, superior thermal conductivity, and enhanced wear resistance. To successfully integrate these ideas, it is necessary to develop method to obtain filament from a highly filled feedstock and to bring it into the printing (layer-by-layer deposition method) process.

### **Acknowledgements**

This work was supported by the Russian Science Foundation (project No 23-69-10001).



## DUAL-DRUG DELIVERY SYSTEMS BASED ON POLYPEPTIDES OF DIFFERENT ARCHITECTURE

*Dzhuzha A.Yu.<sup>1,2</sup>, Levit M.L.<sup>1</sup>, Korzhikova-Vlakh E.G.<sup>1,2</sup>*

<sup>1</sup> Saint Petersburg State University, Saint Petersburg, Russia

<sup>2</sup> Institute of Macromolecular Compounds Russian Academy of Sciences, St. Petersburg, Russia

PhD student

[polinadzhuzha@mail.ru](mailto:polinadzhuzha@mail.ru)

The development of novel drug carriers which can increase the effectiveness of therapy due to the reduction of side effects, enhancing bioavailability and enabling prolonged and targeted delivery of a drug is an urgent task in terms of modern treatment strategies. Currently, systems for combined drug delivery which allow loading therapeutic substances of different nature are of a great importance, since the range of potentially applicable drugs is growing, as well as new approaches to the treatment of various diseases are being developed. Nowadays, growing attention is paid to polymeric drug delivery systems as perspective forms of drug carriers which offer the versatility and easy manipulation needed to address a wide range of therapy applications.

Polypeptides are a class of synthetic polymers that have significant promise for being a constituent of a modern drug/gene delivery system due to their biodegradability, biocompatibility, ease of modification and others. Amphiphilic polypeptides can self-assemble in aqueous solutions over the critical micelle concentration to form structures of various morphology enabling encapsulation of drug substances into it. Recently, random polypeptides containing L-lysine, L-glutamic acid, L-phenylalanine, L-isoleucine residues taken in different ratio were synthesized and studied in terms of drug and gene delivery properties [1, 2].

In this research, in order to obtain dual-drug loaded delivery systems, the synthesis of poly( $\alpha$ ,L-glutamic acid) and poly( $\alpha$ ,L-lysine) by ring-opening polymerization of  $\alpha$ -amino acid N-carboxyanhydride (NCA) monomers was performed. Post-polymerization modification of synthesized homopolymers with various hydrophobic and basic amino acids and D-glucosamine resulted in set of amphiphilic polyaminoacids of different structures and capable of encapsulation of hydrophobic drugs and negatively charged nucleic acids. At the same time copolymers of 2-deoxy-2-methacrylamido-D-glucose and 2-aminoethyl methacrylate taken in different ratio were synthesized *via* RAFT-polymerization and further grafted with polyaminoacids. <sup>1</sup>H NMR and HPLC were applied to determine the copolymers' composition. Prepared from synthesized copolymers nanoparticles were characterized by dynamic and electrophoretic light scattering (DLS and ELS) and transmission electron microscopy (TEM), and studied in terms of their stability, cytotoxicity and encapsulation efficiency. The obtained copolymers were used for the preparation of single and dual delivery systems of Paclitaxel and Irinotecan or Paclitaxel and short double-stranded nucleic acid. The resulting systems were characterized in terms of their physicochemical and biological properties.

### References

- [1] O. Osipova *et al.*, *Journal of Drug Delivery Science and Technology*, **2022**, 69, 103135
- [2] D. Iudin *et al.*, *Pharmaceutics*, **2020**, 12(9), 868

### Acknowledgements

This work was supported by Russian Science Foundation (project №21-73-20104).

The Research Park of Saint-Petersburg State University is acknowledged (Chemical Analysis and Materials Research Centre, Centre for Molecular and Cell Technologies and Magnetic Resonance Research Centre).

## SYNTHESIS AND EVALUATION OF THE EFFECTIVENESS OF POLYCARBOXYLATE SUPERPLASTICIZER

*Fedoskin I.A.<sup>1</sup>, Markov E.S.<sup>2</sup>, Vasiliev A.S.<sup>2</sup>, Trishin Yu.G.<sup>1</sup>*

<sup>1</sup>St. Petersburg state university of industrial technologies and design. Higher School of Technology and Energy, St. Petersburg, Russia

<sup>2</sup>Company MC-Bauchemie, Kirovsk, Leningrad reg., Russia  
Postgraduate

[IwanFedoskin@yandex.ru](mailto:IwanFedoskin@yandex.ru)

Modern technologies for the production of concrete mixtures use a variety of organic and non-organic additives to improve the properties of the final product, such as: increased plasticization, water reduction, frost and corrosion resistance, as well as maintaining the mobility of the concrete mixture. One of the representatives of the additives used are polycarboxylate superplasticizers obtained by copolymerization of acrylic acid and its derivatives with alkenyl polyethylene glycols. Copolymers have a branched comb-like structure, which makes it possible to use them as dispersants.

Currently known superplasticizers have high properties, but research continues on the development of more effective superplasticizers for use as additives in concrete.

In this work, a polycarboxylate superplasticizer based on acrylic acid and polyethylene glycol methyl ether was synthesized by free radical polymerization under conditions close to those described in [1] (Scheme 1). The initiating system was represented by ammonium persulfate and ascorbic acid, and mercaptopropionic acid acted as a regulator of chain growth.

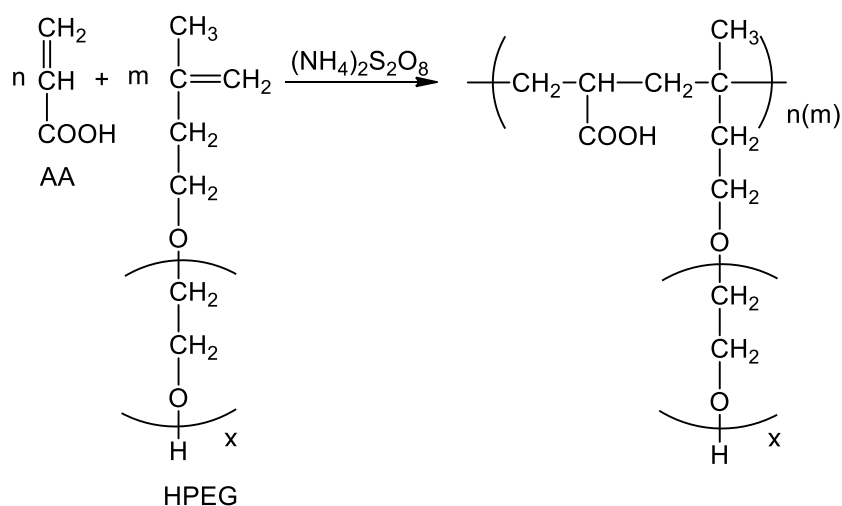

**Scheme 1.** Superplasticizer formation reaction

To determine the effectiveness of the resulting polycarboxylate superplasticizer, an increase in the precipitation of the cone of the concrete mixture was measured in accordance with state standard 10181. It was found that the draft of the cone of the mixture was 235/200/160 mm after 15/60/120 min. accordingly. The initial sample of the concrete mix, without the addition of a superplasticizer, had a cone draft of 50 mm. The data obtained indicate a significant effect of plasticizing concrete with the synthesized additive, which makes it possible to classify it as a superplasticizer according to state standard 24211.

### References

[1] Visser I., Klinkenberg M, Hoos P., Janssen H-G., Duynhoven J. Identification and quantification of polycarboxylates in detergent products using off-line size exclusion chromatography–nuclear magnetic resonance // *Analytica Chimica Acta*, 2009. - Vol. 654. - P. 40-44.

# APPLICATION OF RAMAN SPECTROSCOPY TO RESEARCH IN THE STRUCTURE OF BOVINE SERUM ALBUMIN IN FILMS

*Fedotova E.V., Borisov E. V., Pankin D. V., Paston S.V.*

St. Petersburg State University, St. Petersburg, Russia

Student

[st077318@student.spbu.ru](mailto:st077318@student.spbu.ru)

Raman spectroscopy have been used to understand the structure and conformational changes of proteins. The advantages of this method are a small amount of sample, the ability to study multicomponent systems and complex structures, the negligible contribution of water to the spectrum, and the use of the substance in liquid or solid phase. A Raman spectrum of a protein provides unique signatures for various secondary structures like helices, beta-sheets, turns, random structures, etc., and various amino acid residues such as tyrosine, tryptophan, and phenylalanine [1].

In this work, the structure of bovine serum albumin (BSA) in films obtained from aqueous and 0.15 M NaCl solution is investigated by Raman scattering. The obtained spectra are shown in Figure 1. Vibration bands of different amino acid residues, including aromatic residues, can be identified. By the position and intensity of certain bands, we can judge the polarity of the environment of several amino acid residues. In particular, a decrease in the intensity of the band corresponding to Phe at 621  $\text{cm}^{-1}$  occurs with increasing hydration. The ratio of the intensity of doublet ( $I_{1360}/I_{1340}$ ) changes with the polarity of the solvent. When Trp is more solvent-accessible,  $I_{1360}/I_{1340} < 1$ . Also, the intensity ratio of 850  $\text{cm}^{-1}$  to 830  $\text{cm}^{-1}$  (Tyr) should be considered a marker of the hydrophilic/hydrophobic environment around the residue [1]. The Raman spectra also show clearly the amide I band, which can be decomposed to reveal the contributions of vibrations of the peptide group involved in various forms of protein secondary structure. By deconvolution of this band, we obtained 65% alpha helices for both samples, 1 and 4% beta sheets for BSA in water and NaCl, respectively. These results are in agreement with the literature data.

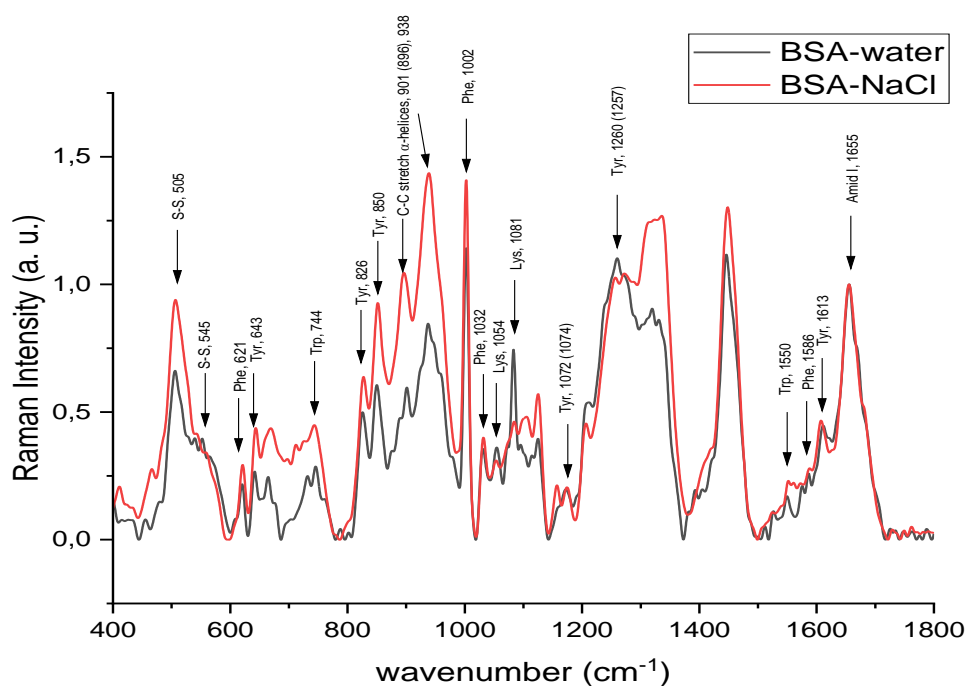

**Figure 1.** Baseline-corrected Raman spectra of BSA films prepared from the water and 0.15 M NaCl solutions.

## References

[1] *Spectrochimica acta. Part A.* **2021**, 258, 119712

## Acknowledgements

The work was carried out using the equipment of the resource center of the Research Park of St. Petersburg State University "Center for Optical and Laser Materials Research".

# POLYMERIC MEMBRANE FUNCTIONALISED WITH 4'-AMINOBENZO-15-CROWN-5-ETHER (4AB15C5) FOR LITHIUM EXTRACTION

*Filippova I.S., Dmitrieva M.A., Doroshenko I.V.*

ITMO University, Chemical and Biological Cluster, SCAMT International Science Centre St.  
Petersburg, Russia

Student 1st year of Master's degree

[filippova@scamt-itmo.ru](mailto:filippova@scamt-itmo.ru)

Lithium is an important component for the electronics and energy industries, and demand is growing. One of the most promising ways of extracting it is from the associated waters of oil and gas condensate fields. The extraction of lithium is becoming increasingly important due to growing demand. Traditional methods of lithium extraction from water, such as solar evaporation, face a number of problems: process duration, use of large areas, dependence on weather, presence of other ions and low lithium concentration. Modern direct lithium extraction (DLE) methods using adsorption, ion exchange, solvent extraction, membranes and electrodialysis are more efficient and environmentally friendly. They provide the required extraction rate and removal of unwanted compounds.[1]

An advanced technology for lithium extraction from brines is direct lithium extraction (DLE) based on the use of selective polymer membranes. The membranes used in DLE technology are made of cellulose acetate modified with 4'-aminobenzo-15-crown-5-ether (4AB15C5) to improve their functional properties. The application of cellulose acetate-based polymer membranes for lithium extraction from associated brines of oil and gas condensate fields has the following main advantages: high selectivity for lithium ions, efficient lithium extraction, resistance to aggressive media, relatively low cost and environmental safety. The modification of the cellulose acetate based polymer membrane is shown in Scheme 1. 4AB15C5 has the unique ability to selectively bind lithium ions due to its structure with two benzene rings connected by a 15-atom bridge. This makes the crown ether an ideal candidate for creating membranes with high selectivity towards lithium. The resulting membrane allows lithium ions to pass through while leaving other ions behind, resulting in a high degree of lithium purification. Crown ethers can be used to modify polymeric membranes. There are many crown ethers with different sizes and functional groups allowing the best option to be selected for a particular application, in this study 4AB15C5 showed good selectivity for Li<sup>+</sup> in solution.[2]

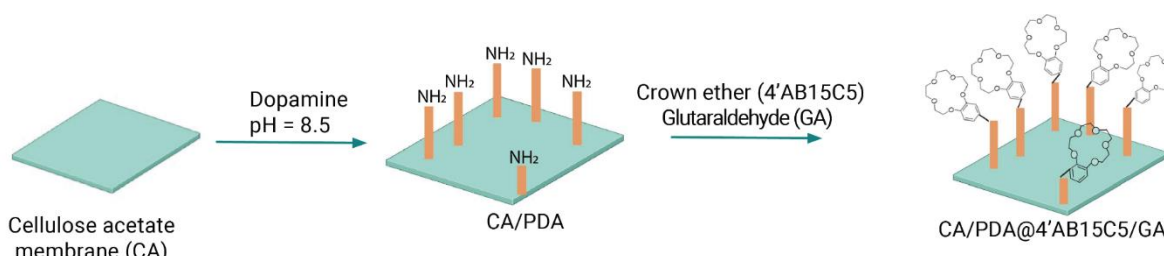

**Scheme 1.** Scheme for obtaining polymer membrane modification with 4AB15C5

The use of direct lithium extraction (DLE) using cellulose acetate polymer membranes modified with crown ether compounds allows lithium extraction with high efficiency and selectivity. The unique properties of such membranes, which provide selective permeability for lithium ions while retaining other ions, make this technology highly attractive for industrial scale-up and implementation in lithium extraction processes.

## References

[1] *Mends E.A., Chu P. Lithium extraction from unconventional aqueous resources – A review on recent technological development for seawater and geothermal brines // Journal of Environmental Chemical Engineering. 2023. Vol. 11, № 5.*

[2] *Sun Y. et al. A novel approach for the selective extraction of Li<sup>+</sup> from the leaching solution of spent lithium-ion batteries using benzo-15-crown-5 ether as extractant // Sep Purif Technol. 2020. Vol. 237.*

## Acknowledgements

The Priority 2030 Federal Academic Leadership Program for infrastructural support.

## FUNCTIONAL MATERIALS BASED ON FLUORINATED POLYMERS FOR FUEL CELLS AND ELECTROACTIVE DEVICES

*Golubkov S.S.<sup>1,2</sup>, Statsenko T.G.<sup>1</sup>, Mamontov M.A.<sup>1</sup>, Don G.M.<sup>3</sup>, Lihomanov V.S.<sup>1</sup>, Sanginov E.A.<sup>3</sup>, Belmesov A.A.<sup>3</sup>, Kashin A.M.<sup>1</sup>, Levchenko A.V.<sup>3</sup>, Morozova S.M.<sup>1</sup>*

<sup>1</sup>Moscow Institute of Physics and Technology, National Research Institute, Institutsky Lane, d 9, Dolgoprudny, Russia

<sup>2</sup>N.E. Bauman Moscow State Technical University, 2nd Baumanskaya St. 5/1, 105005 Moscow, Russia

<sup>3</sup>Federal Research Center for Problems of Chemical Physics and Medical Chemistry of the Russian Academy of Sciences, Academician Semenov Ave., 1, Chernogolovka

PhD Student

[GolSerg97@yandex.ru](mailto:GolSerg97@yandex.ru)

Fluorinated polymers are of great interest due to their unique properties such as low refractive index, high chemical stability and high hydrophobic properties. Emulsion polymerization is a common way for obtaining fluorinated polymers and modify them by copolymerization with other functional monomers. For example, Aquivion® is commercial perfluorinated polymer which consist from tetrafluoroethylene hydrophobic blocks and sulfo-containing ionic blocks (Fig. 1a). Due to self-assembly of hydrophilic and hydrophobic blocks it demonstrates high ionic conductivity which is in a high demand for development of fuel cells (FC) (Fig. 1b). Aim of this study was to obtain by emulsion polymerization fluorinated polymers with different structures and investigate the possibility of their application as proton-conductive membranes for FC and as 3D printable electroactive actuators. In first direction the effect of annealing conditions on the mechanical properties and proton conductivity of the membranes based on a perfluorinated polymer with the Aquivion structure was investigated (Fig. 1c). Film samples obtained from polymer dispersions in N,N-dimethylacetamide (DMAA) and in an aqueous-alcohol mixture were studied. Annealing was carried out in vacuum in a temperature range from 140 to 160 °C for 3-8 hours.

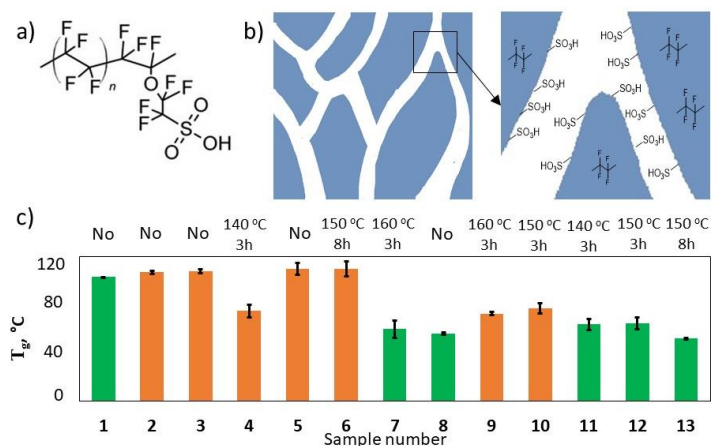

**Figure 1.** a) Chemical structure of the copolymer (Aquivion); b) Schematic representation of the copolymer microstructure; c) The glass transition temperature of the samples obtained according to the DMA data. Samples cast from water-alcohol dispersion are highlighted in green, and samples from DMAA are highlighted in orange. Annealing conditions are signed at the top of the column, where "NO" means absence of annealing.

By dynamic mechanical analysis (DMA) it was shown that membranes obtained from DMAA have, on average, greater strength with a Young's modulus of  $923 \pm 235$  and  $697 \pm 155$  MPa at 35 and 100 °C, respectively, compared with membranes obtained from ROH/H<sub>2</sub>O which demonstrates Young's modulus of  $588 \pm 194$  and  $398 \pm 142$  MPa at 35 and 100 °C, respectively. Membrane electrode assemblies based on sample 6 demonstrates power density up to 400 mW/cm<sup>2</sup>. Fluorinated polymers based on 1H,1H,5H-octofluoropentyl methacrylate was synthesized and used as an additive to obtain 3D printable electroactive actuators. Rheological properties of obtained ink were studied. Next stage of work will be related with optimization of electrochemical properties of printed materials.

### Acknowledgements

This work was supported by the Ministry of Science and Higher Education of the Russian Federation (Goszadaniye) 075-03-2023-106, project No FSMG-2022-0012.

## THE SYNTHESIS OF MOLECULARLY IMPRINTED POLYANILINE SPECIFIC FOR ZEARALENONE BASED ON EXPERIMENTAL DESIGN

*Gorlo V.D., Pidenko P.S., Burmistrova N.A.*

Saratov State University, Saratov, Russia

Student

[victoriya.gorlo@yandex.ru](mailto:victoriya.gorlo@yandex.ru)

Zearalenone (ZEN) is a non-steroidal estrogenic mycotoxin produced by numerous species of mould fungi of the genus *Fusarium*. It is a contaminant of agricultural crops and products based on them [1]. ZEN is toxic and wide distributed in Russian Federation and EAEU (control level in grain crops — 1.0 mg /kg). That's require developing new low-cost test systems with highly stable receptor elements for ZEN determination directly at fields.

Labour-intensive sample preparation is required for ZEN determination by instrumental methods. Molecularly imprinted polymers (MIPs) are synthetic receptors, are promising materials for ZEN extraction from grain samples. Nowadays MIPs are successfully used as receptors for ZEN determination at pseudo-ELISA format [2]. Aniline and its derivatives are one of the most common monomers used to form the MIPs polymeric network. Aniline self-assembly leads to the formation of polyaniline (PANI), which characterized by environmental safety, low-cost and long-term stability. The formation of selective cavities is due to association between aniline monomer and template through hydrogen bonding [3]. Toxic templates can be replaced during MIPs synthesis to safer dummy-templates Coumarin derivatives and quercetin are dummy-templates in the case of ZEN.

One of the main challenges of the MIPs design is selecting and optimizing of multitude parameters for affecting polymer matrix synthesis, binding site formation, template molecule extraction and re-binding to the analyte. Optimization using statistical design of experiment (DoE) is a fast and efficient method that allows to reduce experimental steps to achieve the best specificity of MIP. DoE takes into account interactions between parameters and provides a better understanding of the process [4,5].

The purpose of this work is to apply DoE for optimization of the synthesis PANI MIPs selective for zearalenone on the microtitration plate surface. Quercetin was used as a template molecule. Optimal conditions for crucial MIPs synthesis steps (template concentration, synthesis time and presence of enzyme) were selected by DoE screening experiment. The optimal synthesis conditions were chosen according to the matrix of the second order central composite plan.

### References

- [1] *Toxins*. **2014**. 6, 1080
- [2] *Eur. Polym. J.* **2021**. 145, 110023
- [3] *Anal.Chem.* **2014**. 86, 959
- [4] *Anal. Chim. Acta.* **2004**. 504, 7
- [5] *Anal. Lett.* **2022**. 55, 2394

### Acknowledgements

This work was supported by the Russian Science Foundation (project No 22–16–00102).

# THE EFFECT OF A POLYMER BINDER ON THE COLOR AND RHEOLOGICAL CHARACTERISTICS OF THE PYROTECHNIC COMPOSITION OF BLUE FLAME

*Gotfried S.D.<sup>1</sup>, Mikhalev D.B.<sup>1</sup>, Belyakov A.V.<sup>1</sup>*

<sup>1</sup> D. Mendeleev University of Chemical Technology of Russia, Moscow, Russia

Junior researcher TSL "PHM"

[sonyagotfrid@list.ru](mailto:sonyagotfrid@list.ru)

Currently, more and more attention is being paid to the use of pyrotechnics for entertainment purposes. The main colors used in fireworks products were mainly the compositions of red, green, and yellow signal lights [1,2]. The development of compositions of blue fire with improved color characteristics is one of the most difficult tasks facing the developers of pyrotechnic compositions. [3]

At the moment, the blue fire compositions produced by the through-pressing method are made on the basis of cellulose nitrates [4]. Of particular interest is the study of the effect of a polymer binder on the color characteristics and the possibility of processing these compositions.

The purpose of the work is to study the effect of a polymer binder on color and rheological characteristics.

The influence of polymer base on the emission spectrum and light characteristics of the standard pyrotechnic composition of blue flame was investigated. Samples were based on nitrocellulose (NC), vinyl chloride copolymer with vinyl acetate VA-15, butadiene-nitrile rubber SKN-40 and fluorine-containing elastomer (with rubbers) SKF-32 (Figure 1).

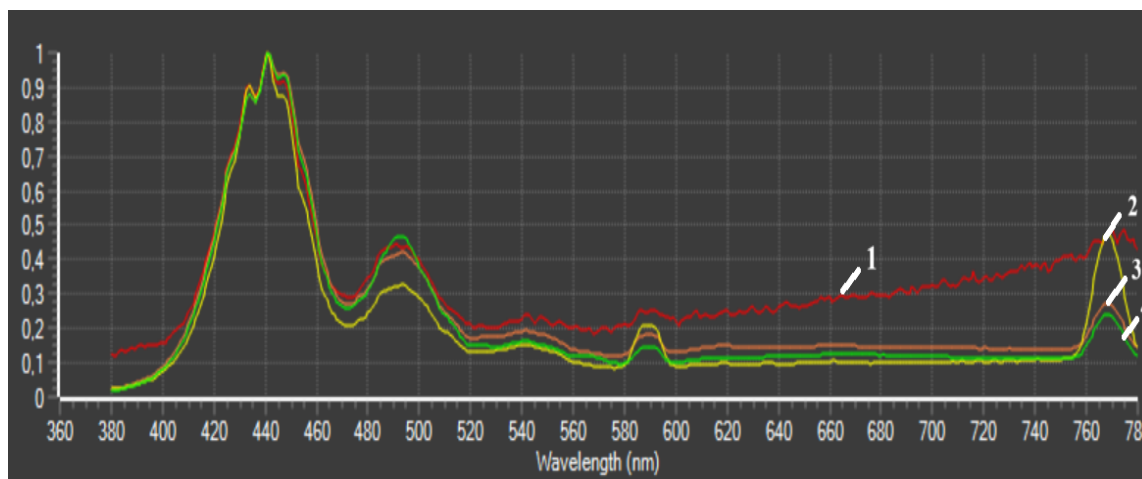

**Figure 1.** Dependence of emission spectrum composition of the blue flame based on the polymer used: 1 – VA-15; 2 – SKN-40; 3 – NC; 4 – SKF-32

It is shown that the use of polymer VA-15 has a negative effect on the full emission spectrum, as well as on color purity, which amounted to 38.89%. Addition of the SKF-32 polymer has a strong effect on the purity of the color, which increased from 38,89% to 58.29%. The rheological characteristics of the compositions depending on the used polymer base are studied in the work. Based on the results obtained, the coefficient of manufacturability was calculated depending on the temperature. The coefficient of manufacturability for compositions on all polymers has a value greater than 1 in the entire temperature range under study, which indicates the possibility of processing these compositions by the through-pressing method.

## References

- [1] Modern pyrotechnics / V. E. Melnikov, Moscow, **2014**, 480
- [2] Fundamentals of pyrotechnics / A. A. Shidlovsky, Moscow, **1973**, 280
- [3] Characteristics of a colored pyrotechnic flame. / Baturova G.S. [et al.], Kazan, 2012, 126
- [4] Patent No.2046122. Pyrotechnic composition of blue fire: No.4955448/21: application. 06/28/1991: publ. 10/20/1995/ Madyakin F.P, Tikhonova N.A., Tyutyunnik O.F. [et al.]; applicant, patent holder Kazan State Technological University.

# DEVELOPMENT OF POLYMERIC CALIBRATION-FREE DEVICE BASED ON OPTICAL SENSORS FOR *IN SITU* ANALYSIS OF BIOLOGICAL FLUIDS

*Gryazev I.P., Peshkova M.A.*

St. Petersburg State University, St. Petersburg, Russia

Student

[iv.gryazev@gmail.com](mailto:iv.gryazev@gmail.com)

The problem of personalization of medicine is becoming more and more relevant. One of the ways of advancement in this direction can be the development of cheap devices for rapid analysis based on polymeric optical sensors (optodes), already used in many fields of science as analytical tools, having low detection limits, insensitivity to electrical interference, and compactness. Calibration-free optode arrays [1] (Fig. 1A), which contain a scale of optical signal standards that can level out the effects of illumination and changes in the sensor phase composition with time on the sensor response, are being actively pursued. However, the interaction of optode compositions with polymeric materials that can be used for analytical devices has not yet been studied. Material inertness and stability of the analytical performance of sensors are key aspects required to utilize such devices in practice.

In this study, the applicability of the optode scale for calibration-free analysis was studied, and the results of preliminary experiments on the interaction of optode compositions with polymer substrate materials (Fig. 1B), the most suitable for the creation of devices for rapid analysis, are reported.

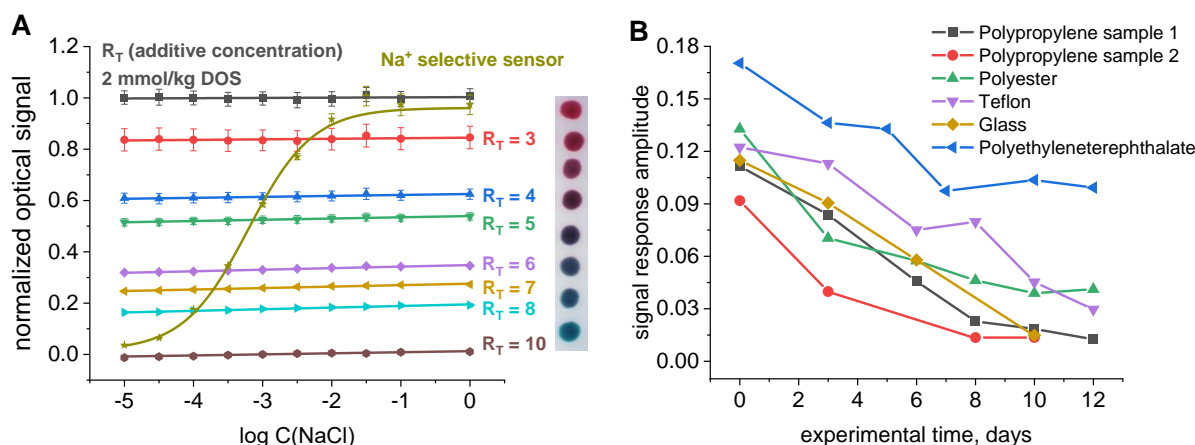

**Figure 1.** A — Response curves of the sensor composition and scale elements of different composition to Na<sup>+</sup> content in the solution; B — Time dependence of the response amplitude of the sensors on different substrates

## References

[1] Tyufyakov N.Yu. *Development and experimental approbation of calibration-free multipurpose arrays of ion-selective optical sensors.* St. Petersburg, 2021. 72 c.

## Acknowledgements

This work was supported by the Russian Science Foundation (project №20-73-10033).



# STUDYING OF THE INFLUENCE OF pH ON THE KINETICS OF RELEASE OF SULFANILAMIDE FROM POLYMER COMPOSITE MATERIAL BASED ON ACRYLIC HYDROGELS AND DETONATION NANODIAMONDS

*Gudkin A.V.<sup>1</sup>, Grigoriev D.V.<sup>2</sup>, Sivtsov E.V.<sup>1</sup>, Uspenskaya M.V.<sup>2</sup>*

<sup>1</sup> St. Petersburg State Institute of Technology, St. Petersburg, Russia

<sup>2</sup> National Research University ITMO, St. Petersburg, Russia

Student

[gudkinartur@gmail.com](mailto:gudkinartur@gmail.com)

During the last decade, the leading direction in the development of medicine has been the use of polymer composite materials (PCMs) with controlled physical and mechanical parameters. An example of such materials are hydrogels, which are three-dimensional polyelectrolyte networks. These PCMs are widely used in medicine and cosmetology: in systems for the controlled release of drugs with a prolonged therapeutic effect, in tissue engineering, in wound dressings for the treatment of various skin lesions.

Hydrogels based on acrylic copolymers can serve as PCM matrices. Acrylic hydrogels have a number of significant advantages: high sorption capacity, sensitivity to external conditions, lack of toxicity and relative low cost. However, they have disadvantages that limit their use: low physical and mechanical properties and the absence of their own biological activity.

To eliminate these disadvantages, an active filler can be added to the structure of the hydrogel. The use of nanoparticles today has become a promising direction in the PCM chemistry. Detonation nanodiamonds (DND) have a combination of unique properties that distinguish them favorably from other nanoparticles. DNDs improve the mechanical characteristics of hydrogels due to the conjugation of functional groups on their surface with polymer chains. In addition, DNDs have an antifungal and antimicrobial effect, disrupting the growth of micromycetes and protein production by microorganisms [1]. Therefore, the use of DND as a filler may be the key to simultaneously improving the performance characteristics of the hydrogel and imparting the biological activity necessary for medical use to it.

To impart targeted therapeutic activity to the gel, sulfonamide was introduced into its structure, which has a bacteriostatic effect and is widely used in the treatment of infected wounds and burns.

Wounds are known to have different pH at different stages of healing. At the stage of the onset of the inflammatory process, the pH is shifted to the acidic region; at the stage of regeneration and in the case of chronic wounds - to alkaline [2].

The kinetics of sulfonamide release from PCM based on acrylic hydrogels filled with DND in water and in solutions of phosphate buffers with a given pH value: 7.9, 7.2, 5.8 has been investigated in the research. Using UV spectroscopy, the dependence of the proportion of released drug substance (DS) on time was obtained. Previously, a calibration direct dependence of optical density on sulfonamide concentration was constructed. The dependence of the proportion of released sulfonamide on time in all media was an exponential curve with a plateau around 90%. The release of sulfonamide had two stages. The first stage is rapid desorption of about 60% of the drug within 200 minutes. The second stage is the release of the remaining sulfanilamyl within 24 hours. Constant (maximum) release was achieved 24 hours after the start of the experiment. With decreasing pH, the proportion of released drug increased and was maximum at pH = 5.8. Therefore, PCM is most effective in treating wounds in the initial stages of inflammation. To mathematically describe the release process, 4 widely used desorption models were considered: Higuchi, Korsmaier-Peppas, Baker-Lonsdale, and Hopfenberg. Based on experimental data ( $R^2 = 0.96$ ) and taking into account assumptions, the Korsmaier Peppas model was chosen, which best describes the release process.

The work also studied the effect of pH on the swelling of PCM: the highest degree of swelling is achieved at the highest pH.

Based on the time of complete release of the drug from the hydrogel, we can talk about the possibility of a prolonged therapeutic effect using PCM as a wound dressing.

## References

- [1] *Image Journal of Advanced Materials and Tech.* **2021**, 6, 54
- [2] *Acta Dermato-Venerologica* **2013**, 93(3), 261

# SYNTHESIS OF TRIPLE COPOLYMERS OF COLLAGEN-POLYSACCHARIDE-METHYL METHACRYLATE AS A BASIS OF BIOMATERIAL FOR REGENERATIVE MEDICINE

*Gushchina K.S.<sup>1</sup>, Lobanova K.S.<sup>1</sup>, Vavilova A.S.<sup>1</sup>, Kuznetsova Yu.L.<sup>1</sup>*

<sup>1</sup> National Research Lobachevsky State University of Nizhny Novgorod, Nizhny Novgorod, Russia  
Graduate student

[ksesha.gushchina@gmail.com](mailto:ksesha.gushchina@gmail.com)

An important task of modern medicine is the restoration of damaged tissues in the human body. Tissue engineering has become a new approach, the purpose of which is the construction and cultivation of functional tissues or organs to replace or stimulate the regeneration of damaged organs or tissues. To achieve the goal, develop an optimal biomaterial (scaffold) that promotes skin cell adhesion, differentiation, proliferation, and viability [1]. Scaffolds are constructed using both natural and synthetic polymers, each with its own set of advantages and disadvantages [2]. Natural polymers exhibit biocompatibility and biodegradability and provide cell adhesion but may lose mechanical properties during scaffold formation. Synthetic polymers have good strength and elasticity but often decompose poorly, and their monomers are frequently toxic. In recent years, grafted copolymers consisting of a combination of natural and synthetic polymers have been developed. This research aims to synthesize and investigate the properties of copolymers composed of collagen, a polysaccharide (pectin or chitosan), and methyl methacrylate. The alkylborane amine complex, as well as the complex together with *p*-quinone, were used as an initiator in the synthesis of the copolymers. Alkylboranes enable the production of crosslinked copolymers of collagen and acrylic monomers [3]. *p*-Quinone promotes controlling the molecular weight of the grafted fragment [4].

Copolymers consisting of collagen, pectin, and methyl methacrylate were synthesized using different ratios of the components. The obtained copolymers were studied using IR spectroscopy, scanning electron microscopy, and gel-penetrating chromatography. It was found that the molecular weight of grafted PMMA depends on the component ratio, and copolymer morphology correlates with the amount of grafted PMMA. A hydrogel was obtained with an increased concentration of the components in the polymerizing mixture. The MTT assay was used to evaluate cytotoxicity, and the sample was found to be non-toxic (Fig. 1).

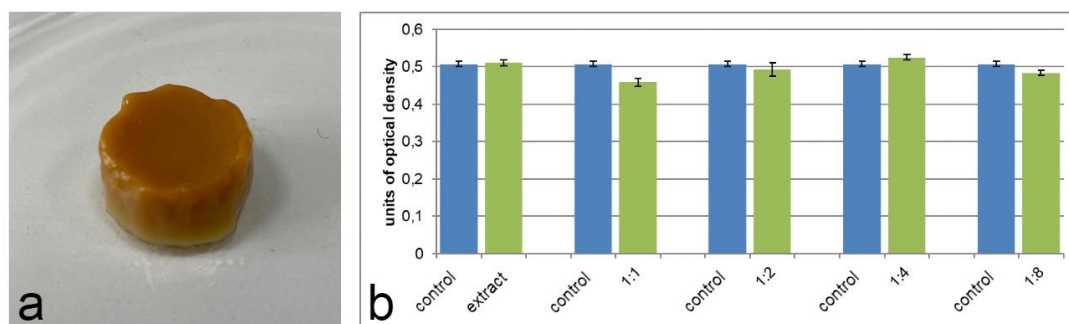

**Figure 1.** The hydrogel composed of collagen, pectin, MMA, and initiator (a); the results of the MTT assay (b).

Collagen, chitosan with different molecular weights, and methyl methacrylate copolymers were synthesized at a mass ratio of 3:1:6 and studied similarly to previous samples. The morphology of copolymers varies depending on the molecular weight of chitosan. Additionally, the inclusion of *p*-quinone causes a decrease in molecular weight, leading to a smaller pore size.

The produced copolymers have potential applications in regenerative medicine.

## References

- [1] *J. of Care Skin and Dermatology* **2018**, 1, 101
- [2] *Polym. Chem.* **2020**, 11, 184–219
- [3] *Polymers* **2022**, 14(16), 3290
- [4] *Polymers* **2023**, 15(12), 2618

## Acknowledgements

By the support of the federal academic leadership program “Priority 2030” of the Ministry of Science and Higher Education of the Russian Federation.

## SPREAD AND ADSORBED LAYERS OF PLANT PROTEIN CUPIN-1.1 AND ITS AGGREGATES

*Isakov N.A.*<sup>1</sup>, *Belousov M.V.*<sup>1,2</sup>, *Nizhnikov A.A.*<sup>1,2</sup>, *Noskov B.A.*<sup>1</sup>

<sup>1</sup> St. Petersburg State University, St. Petersburg, Russia

<sup>2</sup> All-Russia Research Institute for Agricultural Microbiology, St. Petersburg, Russia

Student

[st055657@student.spbu.ru](mailto:st055657@student.spbu.ru)

Protein and their aggregates have been considered candidates for interface stabilization, such as in foams and emulsions, for several decades [1]. Despite that the data on surface properties of adsorbed and spread layers of protein aggregates is rather deficient. Furthermore, it has been just recently that plant proteins and their aggregates began to attract attention as a result of searching for more feasible and eco-friendlier materials.

Cupin-1.1 is a domain of pea storage protein vicilin and it was expressed using previously constructed plasmid and *E. coli* strain BL21 [2]. In this work, the layers of amorphous aggregates of cupin-1.1 at the air/water interface are studied by the surface tensiometry, dilational surface rheology and atomic force microscopy. Due to its low solubility in water cupin-1.1 tends to form aggregates when exposed to water while they are dissolved, at least partly in 8M urea solution [2]. These aggregates at the water surface tend to undergo partial disaggregation to form a layer with unique dynamic properties, which were not discovered for the aggregate layers of other studied proteins. The dependency of the dynamic elasticity of the layer on surface pressure displayed two local maxima with the second peak being four times higher than the first one. The explanation of the first maximum is based on the similarity of the obtained results with the data for polymer microgels when a hairy corona of the microgel particle stretches along the surface at the beginning of compression and forms loops and tails at the further compression leading to a decrease of the surface elasticity [3]. The second local maximum of the dynamic surface elasticity is presumably caused by the interactions of the rigid cores of the aggregates leading finally to the formation of multilayer structures at high surface pressures. In this case the surface elasticity starts to decrease as a result of the segment exchange between different layers at the interface [4]. 8M urea influences the layer properties but the main features of the surface elasticity as a function of surface pressure are preserved indicating that the aggregation still occurs in such hostile conditions.

### References

[1] *Adv. Colloid Interface Sci.* **2020**, 276, 102086

[2] *PLOS Biology* **2020**, 18, 7

[3] *Soft Matter* **2014**, 10, 36

[4] *Colloids Surf A* **2010**, 354, 1-3

### Acknowledgements

This work was supported by the Russian Science Foundation (project No 24-13-00261).

# CYPERMETHRIN AND PERMETHRIN-BASED POLYACRYLATE COMPOSITE FILMS FOR TICK BITE PREVENTION

*Istomina L.I.*<sup>1</sup>, *Zverev S.A.*<sup>1</sup>

<sup>1</sup> Disinfectology Institute of F.F. Erisman FSCH of Rosпотrebnadzor, Moscow, Russia

Junior researcher

[li\\_istomina@mail.ru](mailto:li_istomina@mail.ru)

It is estimated that approximately 500,000 tick attacks occur annually in the Russian Federation. However, there are currently no effective means of preventing the majority of infectious diseases carried by ticks. The *Ixodes ricinus* and *Ixodes persulcatus* ticks are of the greatest epidemiological importance on the territory of Russia. Of these, the latter species is particularly dangerous, as taiga ticks are much more often carriers of infectious diseases. Protective clothing is an effective means of defence against attacks of ixodes ticks [1]. Pyrethroids, typically permethrin and cypermethrin, have historically constituted the primary active substances employed in this context.

This work describes a new technology of creating materials based on textile materials from synthetic and natural fibres and polyacrylate films containing cypermethrin and permethrin. To create the materials, a laboratory analogue of a dryer-shear machine was developed, with the furnace used to initiate polymerization. A series of fabrics with concentrations of cypermethrin and permethrin ranging from 0.5 to 5.0 g/m<sup>2</sup> were obtained using the proposed technology. The active ingredient concentration in the obtained tissues was determined by gas-liquid chromatography with flame ionisation detection. The limit of detection (LOD) for cypermethrin in tissue was 0.210 g/m<sup>2</sup>, while the limit of detection for permethrin was 0.206 g/m<sup>2</sup>. The limit of quantitative detection (LOQ) values were 0.624 g/m<sup>2</sup> for cypermethrin and 0.635 g/m<sup>2</sup> for permethrin. The obtained samples were also characterised by scanning electron microscopy. The durability of the materials was evaluated by the preservation of the active ingredient after washing. The manufactured samples retained more than 90% of the active ingredient after 50 washes.

The migration ability of pyrethroids from tissue to sweat fluid was evaluated. A model of sweat fluid was constructed, and the degree of diffusion of the active substance from the tissue for different times was estimated. To simulate real tissue conditions, the minimum time of the experiment was one hour, and the maximum time was eight hours. Despite the low water solubility of pyrethroids, the experiment demonstrated that only three out of ten formulations exhibited no detectable migration of the active ingredient. Comparative efficacy for textile materials with permethrin and cypermethrin was evaluated against taiga mites of the *I. persulcatus* species. The parameters evaluated were the maximum height of the tick on the treated textile, the knockdown time, defined as the time until the tick falls off the treated textile, and the tick bite rate [2].

In this study, materials based on textile and polyacrylate films with varying concentrations of cypermethrin and permethrin were produced and evaluated. The resulting materials exhibited high efficacy against *I. persulcatus* ticks, making them promising candidates for tick control.

## References

[1] *Vector-Borne and Zoonot. Dis.* **2011**, 11(7), 869-875

[2] *Exp. Appl. Acarol.* **2023**, 89, 275-286

## APPLICATION OF FTIR SPECTROSCOPY TO STUDY THE B-A TRANSITION IN THE SECONDARY STRUCTURE OF DNA

*Ivanova D.N., Borisov E. V., Pankin D. V., Paston S.V.*

St. Petersburg State University, St. Petersburg, Russia

Student

[st076983@student.spbu.ru](mailto:st076983@student.spbu.ru)

The secondary structure of DNA is determined by its interaction with solvent molecules. In the cell and in aqueous solutions, water and low molecular weight ions are immersed into the DNA structure. The high dielectric constant of water and hydrated counterions weaken the electrostatic repulsion of the phosphate groups of the complementary DNA strands. Hydrophobic nitrogenous bases move away from contact with water, grouping in the center of the double helix. The degree of DNA hydration  $G$  determines the form of the secondary structure of the macromolecule: with  $G \geq 20$  (water molecules)/nucleotide DNA is in the B-form, with  $G \leq 20$  (water molecules)/nucleotide the secondary structure of DNA belongs to the A- or C-family, depending on the type of the counterion [1]. The secondary structure of DNA is the most important factor in its functioning. B-DNA form occurs under the conditions in cells and solutions. The A-form is found in partly dehydrated samples of DNA, and also in the cell it may organizing in hybrid pairings of DNA and RNA strands during replication and transcription, and in enzyme-DNA complexes [2].

In this work, the secondary structure of DNA in a water-salt solution and films of different humidity is studied using Fourier transform infrared spectroscopy. The spectra were recorded continuously during the drying of a drop of DNA solution on the crystal of the ATR attachment with a flow of dry nitrogen. The amount of water in the samples under study is such that the IR spectra at the initial stage of drying contain only spectral bands characteristic of vibrations of the water molecule. In the IR spectra of films with a low water content, lines of the IR spectrum of DNA are observed, which change as the humidity of the films decreases. These changes can be interpreted as signs of a B-A transition in the secondary structure of DNA. One of the main markers of the B-A transition is the position of the peak caused by asymmetric stretching vibrations of phosphate groups  $PO_2^-$ : the position  $1225-1220 \text{ cm}^{-1}$  corresponds to the B-form, and  $1245-1235 \text{ cm}^{-1}$  to the A-form [3]. Each spectrum obtained was normalized to its peak intensity of  $(963 \pm 2) \text{ cm}^{-1}$  (caused by the C-C stretching vibrations of the sugar-phosphate backbone). C-C bonds do not form bonds with ions from solution, therefore the spectral changes in this peak are insignificant in the experiment under consideration. The normalization procedure eliminated the error in concentrations that occurs when samples are dried. During the dehydration of DNA films, a decrease in the intensity of the bands corresponding to the deformation and stretching vibrations of the water molecule ( $3000-3600 \text{ cm}^{-1}$ ) was observed. Thus, as the humidity of the films decreases, a B-A transition is observed in the secondary structure of DNA. The work examines the influence of ionic conditions and defects in the structure of B-DNA on the features of B-A transition.

### References

- [1] *W. Saenger, Principles of Nucleic Acid Structure, Springer-Verlag, 1984.*
- [2] *B. Alberts, A. Johnson, J. Lewis, et al, MBOC, 5<sup>th</sup> Ed., 2008.*
- [2] *Nucleic Acids Research 2011, 39, 5439.*

### Acknowledgements

The work was carried out using the equipment of the resource center of the Research Park of St. Petersburg State University "Center for Optical and Laser Materials Research".

## CO-SOLVENTS EFFECTS IN THE DEVELOPMENT OF A DRUG DELIVERY SYSTEM FOR PHOTOSENSITIZERS USING COPOLIMER DEXTRAN-POLY(N-ISOPROPYLACRYLAMIDE)

*Kablov I.V.<sup>1</sup>, Kaskeh V.<sup>2</sup>, Kravchenko I.E.<sup>1</sup>, Zorina T.E.<sup>1</sup>, Zorin V.P.<sup>1,2</sup>*

<sup>1</sup> Belarusian State University, Minsk, Belarus

<sup>2</sup> International Sakharov Environmental Institute of Belarusian State University, Minsk, Belarus

Post-graduate

[iv.kablov@gmail.com](mailto:iv.kablov@gmail.com)

Stimulus-sensitive polymers characterized by the presence of a phase transition in the physiological temperature region have great potential for biomedical applications [1]. Tissues of the body are characterized by different temperature values. The values of this parameter are different for healthy and malignant tissues [2]. This allows the application of temperature sensitive polymers for targeted drug delivery and controlled drug release. For example of such polymer systems is a temperature-dependent copolymer of dextran and poly-N-isopropylacrylamide (DPNIPAm), which changes its structural state from a free club at low temperatures to a compact condensed globule at high temperatures (above 34-35 °C).

Previous studies have shown that copolymers based on dextran and poly-N-isopropylacrylamide can be used for the incorporation of nonpolar porphyrin and chlorin photosensitizers (PSs). The efficiency of drug incorporation depends not only on the structural state of the copolymer, but also on the degree of polarity of their molecules [3].

The ability to incorporate drug molecules into nano-carriers can be influenced by the use of co-solvents. It has been shown that the degree of drug incorporation into poly-N-isopropylacrylamide hydrogel increases if organic solvents were used at the stage of formation of polymer-drug complexes [4].

In this work, the influence of organic co-solvents (ethanol and dimethylsulphoxide (DMSO)) on the efficiency of incorporation of hydrophobic photosensitizers molecules into the thermoresponsive copolymer was evaluated.

The branched star-shaped DPNIPAm was synthesised at Taras Shevchenko National University of Kyiv. The value of the lower critical solution temperature for DPNIPAm is 34-35 °C [3]. The following PSs were studied in this work: 5,10,15,20-tetra-(4-hydroxyphenyl)chlorine (mTHPC), produced by Biolitec Research GmbH (Germany); 5-(4-hydroxyphenyl)-10,15,20-triphenylporphyrin (THPP), produced by Porphyrin Products (USA).

The molecules DPNIPAm are in the condensed state at temperatures above the critical point. At temperatures between 34-35 °C, there is a phase transition, which leads to significant changes in the structure of the polymer molecule. mTHPC could be simply encapsulated into the DPNIPAm copolymers at the temperature above critical one. It was demonstrated, that the addition copolymers to the aqueous mTHPC solution is accompanied with complete monomerization of photosensitizer. When cooling to below critical temperatures, mTHPC molecules release from the complexes forming molecules aggregates in the aqueous surrounding.

Chemical modification of the PS molecule by replacing part of the phenyl rings in the mTHPC macrocycle with benzene rings leads to a decrease in the efficiency of complexation with the copolymer in the condensed state compared to mTHPC. THPP in a copolymer solution at temperatures above the critical temperature only partially disaggregates. To increase the degree of immobilization of THPP, small amounts of organic solvents (ethanol and dimethyl sulfoxide) were added to the copolymer solution. It was shown that the presence of dimethyl sulfoxide leads to an increase in the amount and rate of incorporation of PS into the copolymer, while the presence of ethanol does not change these parameters. We believe that such effects are caused by differences in the processes of interaction of cosolvents with the polymer molecule in the condensed state.

### References

- [1] *Progress in Polymer Science* **2021**, 131, 101578
- [2] *Biomedicines*. **2022**, 10(8), 2024
- [3] *Ukrainian Journal of Physics* **2020**, 65(7), 638
- [4] *Journal of Applied Polymer Science* **2021**, 138(40), 51167

### Acknowledgements

This work was supported by the Belarusian Republican Foundation for Fundamental Research (grant No. M24MP-024); state scientific research programmes "Convergence-2025" (task 3.03.7.2) and "Biotechnologies-2" (task 1.29.2); Ministry of Education of the Republic of Belarus.

# MECHANISM AND KINETICS OF CYANATE ESTERS CYCLOTRIMERIZATION IN DIFFERENT MEDIA

*Kachmarzhik A.D.<sup>1</sup>, Nikolaev I.A.<sup>1</sup>, Galukhin A.V.<sup>1</sup>*

<sup>1</sup> Kazan Federal University, Kazan, Russia

Postgraduate student

[sasha.kachma@mail.ru](mailto:sasha.kachma@mail.ru)

Cyanate esters are valuable compounds that transform into widely applicable materials known as cyanate ester resins during curing. These polymers are extensively employed in various important industries like aerospace, electronics, and high-performance applications due to their exceptional high-temperature stability and low dielectric loss [1]. For example, they are commonly used in manufacturing of printed circuit boards, radomes and composite materials.

It is currently believed that cyclotrimerization of cyanate esters might undergo only in the presence of catalysts. Phenol catalysis is the most widely observed and discussed [2], since the main option of cyanate esters synthesis is cyanogen bromide method [3], which implies the use of phenol as a precursor of cyanate ester. Some research indicates a preference for water catalysis instead of phenol one [4]. However, the nature of water catalysis remains undefined. It is reliably known that the key intermediate of the phenol-catalyzed cyclotrimerization of cyanate esters is imidocarbonate, formed by the addition of a phenol molecule to the molecule of cyanate ester. Finally, one of the most challenging aspects in the chemistry of cyanate esters is the mechanism of non-catalyzed polymerization, since the absolute cyanate esters purification is extremely difficult.

The mechanism of non-catalyzed cyclotrimerization has been investigated using 4-biphenyl cyanate as a model compound. The reaction course was tracked using an HPLC analysis. As a result, the novel intermediate of 4-biphenyl cyanate trimerization was observed, then successfully isolated and characterized using an XRD technique. Its role in the cyclotrimerization process was proved by reaction with 4-*tert*-butylphenyl cyanate, followed by an ESI-MS analysis of products (Figure 1).

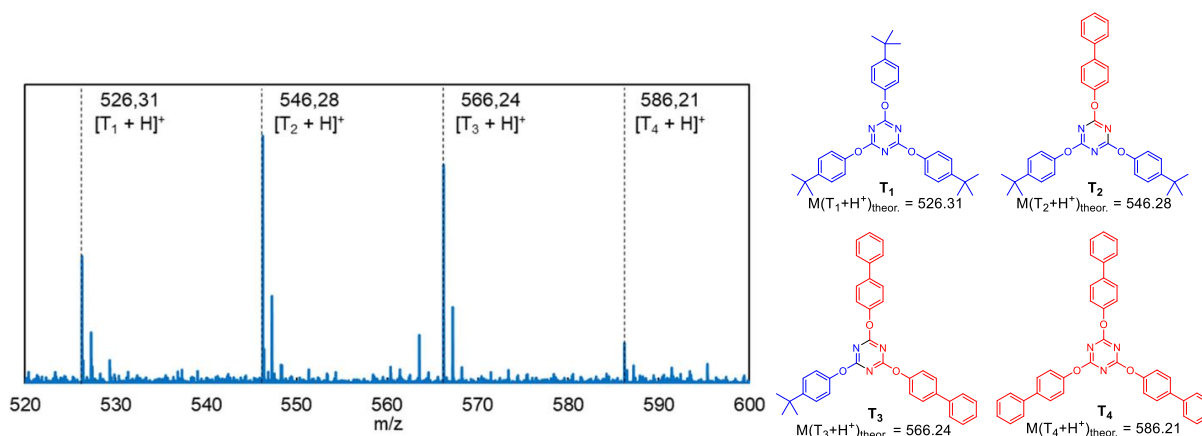

**Figure 1.** Products of novel intermediate and 4-*tert*-butylphenyl cyanate reaction and their identification using an ESI-MS.

In general, the reaction mechanism was identified as a set of reaction channels that differ in bonds cleaving at rate-limiting steps. The explored mechanism has been used to analyze the influence of imidazolium ionic liquids on the cyclotrimerization mechanism and to refute the widely acknowledged autocatalytic character of the reaction.

## References

- [1] *Chemistry and technology of cyanate ester resins*. Springer Science & Business Media, **2012**.
- [2] *Thermochim. Acta*, **2022**, 718, 179382
- [3] *Angew. Chem. Int. Ed.*, **1967**, 6(3), 206
- [4] *Macromol. Chem. Phys.*, **2023**, 224(3), 2200384

## Acknowledgements

This work was supported by the Russian Science Foundation (project No 24-23-00203).

# PALLADIUM COMPLEXES WITH PHOSPHINE-THIOETHER LIGANDS FOR VINYL-ADDITION POLYMERIZATION OF NORBORNENE AND ITS DERIVATIVES

*Karpov G.O.<sup>1</sup>, Bermeshev M.V.<sup>1</sup>*

<sup>1</sup> A.V. Topchiev Institute of petrochemical synthesis, RAS, Moscow, Russia  
[karpov@ips.ac.ru](mailto:karpov@ips.ac.ru)

A vinyl-addition (co)polymerization of norbornene and its derivatives is one of the promising approaches in the design of materials with specified application characteristics. Products of the vinyl-addition (co)polymerization of norbornene derivatives are characterized by high glass transition temperatures, increased thermal stability, greater resistance to solvents, and unique transparency [1–2]. In advance, the copolymerization of norbornene derivatives with ethylene, catalyzed by transition metal complexes, opens up the possibility of controlling the properties of polymeric materials through the controlled introduction of bicyclic polar comonomer units into the structure of the products. The development of highly efficient catalytic systems for (co)polymerization is one of the key conditions for the targeted synthesis of (co)polymers of the required structure. Previously, catalytic systems based on bidentate heteroatomic ligands, in particular, phosphine-sulfonate P-O ligands, demonstrated noticeable efficiency in the (co)polymerization of norbornene derivatives with ethylene [3]. As part of this work, a systematic study of related catalytic systems based on bidentate P-S ligands in the vinyl-addition polymerization of norbornene and its derivatives was carried out for the first time.

Two series of previously undescribed palladium complexes were synthesized. Namely, a series of cationic allylic complexes of palladium bearing bidentate phosphine-thioether ligands and various organometallic anions of the general form  $[(\eta^3\text{-C}_3\text{H}_5)\text{Pd}^+(\text{P-S})]\text{X}^-$  (where  $\text{X} = \text{BF}_4^-, \text{SbF}_6^-, \text{BARF}$ ) was synthesized, along with a series of new neutral complexes with the general structure  $(\text{P-S})\text{Pd}(\text{CH}_3)\text{Cl}$  (Fig.1).

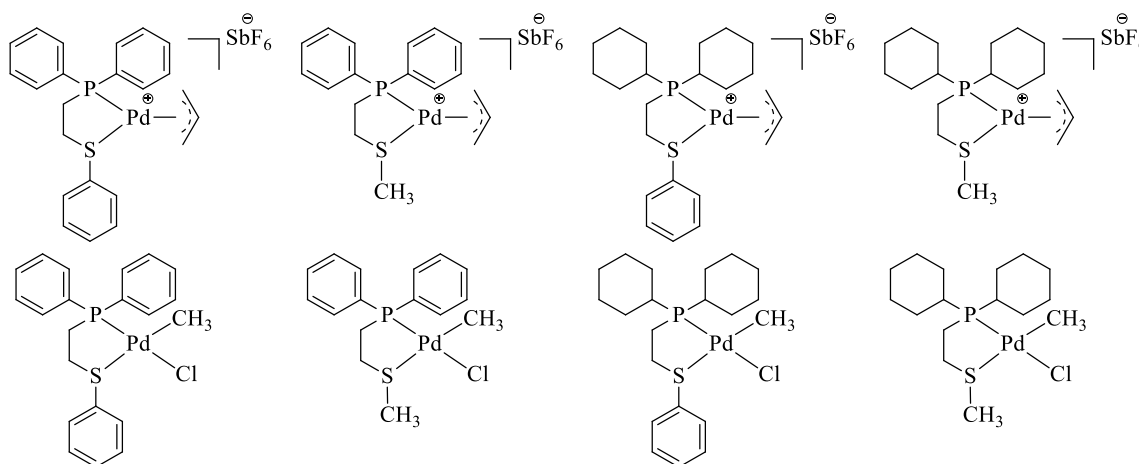

**Figure 1.** Structures of the studied Pd-complexes with phosphine-thioether ligands.

The activity of the new type of catalytic systems was studied in detail and the conditions for vinyl-addition polymerization of norbornene derivatives were optimized for both types of catalysts. The influence of steric bulk and the electronic effects of substituents at phosphorus and sulfur atoms in the ligand structure on the activity of the corresponding catalysts have been established. The most promising strategies for further optimizing the composition of catalysts for the (co-)polymerization of norbornene and its derivatives with ethylene were suggested.

## References

- [1] *Prog. Polym. Sci.* **2018**, 84, 1
- [2] *ACS Macro Lett.* **2023**, 12, 3, 395
- [3] *Macromolecules* **2011**, 44, 4180

## Acknowledgements

This work was supported by the Russian Science Foundation (project No 23-73-01253).



ENHANCING MECHANICAL PROPERTIES OF NBR/EPDM BLENDS  
THROUGH GAMMA RADIATION AND EPOXIDIZED ACRYLONITRILE  
BUTADIENE RUBBER (ENBR) AS A COMPATIBILIZER

*Khankishiyeva R.<sup>1,2</sup>, Mammadova G.<sup>1</sup>, Axundzada H.V.<sup>1</sup>, Azizova A.<sup>1</sup>, Ahmad S.<sup>2</sup>, Khudaverdiev V.<sup>1</sup>*

<sup>1</sup>Institute of Radiation Problems, Baku, Azerbaijan

<sup>2</sup> Azerbaijan University of Architecture and Construction, Baku, Azerbaijan

PhD

[renanamazova0@gmail.com](mailto:renanamazova0@gmail.com)

This study investigates the synergistic effects of gamma radiation and the addition of epoxidized acrylonitrile butadiene rubber (ENBR) as a compatibilizer on the mechanical properties of acrylonitrile butadiene rubber (NBR) and ethylene propylene-diene monomer (EPDM) blends. The objective is to improve the compatibility and overall performance of the NBR/EPDM blend for potential applications in various engineering sectors [1,2].

The acrylonitrile butadiene rubber (NBR) and ethylene propylene-diene monomer (EPDM) based blend is exposed to different doses of gamma radiation (0, 30, 45, 60, 75 and 90 kGy) at room temperature.

The NBR/EPDM blends were prepared with varying compositions, and the influence of gamma radiation on the blend's mechanical properties, such as tensile strength, elongation at break, and impact strength, was systematically investigated. Additionally, ENBR was incorporated as a compatibilizer to enhance the interfacial adhesion between NBR and EPDM phases. The chemical structure of ENBR provides functional groups that can form bonds with both NBR and EPDM, promoting better compatibility and intermolecular interactions. This reaction requires a peroxy-carboxylic acid, such as m-CPBA.

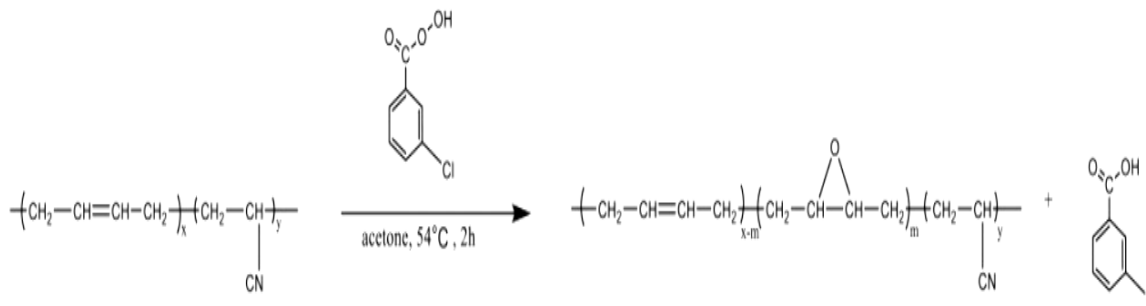

**Scheme 1.** Reaction scheme of epoxidation reaction between NBR and m-CPBA

The irradiated and non-irradiated blends with and without ENBR were characterized using mechanical testing, Fourier-transform infrared spectroscopy (FTIR), and scanning electron microscopy (SEM) to analyze the changes in morphology and chemical structure. The results reveal that gamma radiation induces cross-linking in the polymer matrix, leading to improvements in mechanical properties. Furthermore, the addition of ENBR as a compatibilizer contributes to enhanced interfacial interactions, resulting in improved mechanical performance.

Overall, this study demonstrates the potential of gamma radiation and ENBR as effective strategies to tailor the mechanical properties of NBR/EPDM blends, offering a promising avenue for the development of advanced elastomeric materials with superior performance characteristics.

### References

- [1] *Rad. Phys. & Chem.* **2004**, 71, 17-21  
[2] *J. Chem. & Chem. Tech.* **2023** 17 (4), 829–835

## POLYETHERIMIDES OF COPOLYMER STRUCTURE AND THEIR THERMAL PROPERTIES

*Khina A.G.<sup>1</sup>, Bulkatov D.P.<sup>1</sup>, Buryakov V.S.<sup>1</sup>, Kuleznev A.A.<sup>1</sup>, Storozhuk I.P.<sup>1</sup>*

<sup>1</sup>NTI Center, Bauman Moscow State Technical University, Moscow, Russia  
Researcher  
[alex\\_khina@inbox.ru](mailto:alex_khina@inbox.ru)

Polyetherimides (PEI) constitutes a subclass of polyimides that have increased solubility in organic solvents and the ability to be processed into products by injection molding and extrusion methods due to the high content of hinged ether bonds presented in the structure of their macromolecules [1]. Due to their high technological properties, heat and chemical resistance, PEIs are widely used in many areas of industry, such as aviation, automotive and medical, as well as in electronics, instrument making, 3D printing, etc. [2].

One of the ways to increase the heat resistance of PEIs and to expand their brand range is to introduce rigid-chain fragments into the composition of their macromolecules [3]. In the present work, PEIs of copolymer structure of the MAB line (**Scheme 1**) based on 4,4'-diaminodiphenylmethane, 4,4'-bisphenol A dianhydride (BPADA) and 3,3',4,4'-benzophenone tetracarboxylic dianhydride (BPDA) and of the FAP line (**Scheme 2**) based on 1,3-diaminobenzene, BPADA, and pyromellitic dianhydride (PMDA) were synthesized.

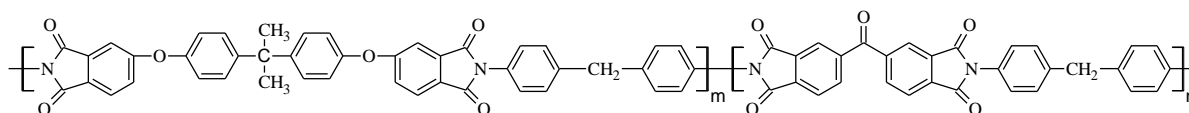

**Scheme 1.** Copolyetherimides of the MAB line.

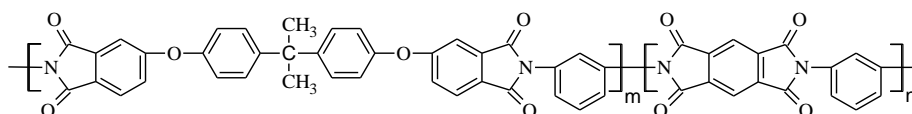

**Scheme 2.** Copolyetherimides of the FAP line.

The synthesis of PEI was carried out using a two-stage procedure to obtain polyamide acid on the first step and its imidization on the second one. The completeness of the polyamide acid cyclization reaction was controlled by the method of Infrared Spectroscopy (IR). It was found using the methods of Differential Scanning Calorimetry (DSC) and Thermogravimetric Analysis (TGA) that the introduction of BPDA and PMDA in the amount of 10-30% mol. makes it possible to increase the glass transition temperature of copolyetherimides of the MAB and FAP series by 10-25°C as well as their thermal-oxidative resistance by 5-10°C. Furthermore, the synthesized PEIs retained the ability to be processed through the melt at temperatures of 350-370°C, which was shown by determining their melt flow index (MFI). Nonetheless, a further increase in the content of BPDA and PMDA fragments in the copolymers structure resulted in the creation of a crystalline phase with a melting point of 370-400°C, leading to the loss of solubility of PEIs, a decline in their melt flow index and, ultimately, to the impossibility of processing through the melt.

### References

- [1] *Polymer*, **2018**, 136, 205-214
- [2] *Progress in Polymer Science*, **2012**, 37, 907-974
- [3] *Polymer Science*, **2021**, 59, 329-339

### Acknowledgements

This work was supported by the competitive development program "Priorities 2030" of BMSTU according with the agreement with the Ministry of Science and Higher Education of the Russian Federation № 075-15-2024-199.

# DYNAMIC PROPERTIES OF ADSORPTION AND SPREAD LAYERS OF STYRENE AND HYDROPHOBISED VINYL BENZYL COPOLYELECTROLYTES

*Khrebina A.D.<sup>1</sup>, Zorin I.M.<sup>1</sup>, Vlasov P.S.<sup>1</sup>, Noskov B.A.<sup>1</sup>*

<sup>1</sup> St. Petersburg State University, St. Petersburg, Russia  
Student

[st076362@student.spbu.ru](mailto:st076362@student.spbu.ru)

The study is devoted to the properties of adsorption and spread layers of amphiphilic copolyelectrolytes of styrene and vinylbenzyl chloride, modified by N,N-dimethyldodecylamine at the water – air interface. The kinetic dependencies of the dynamic surface elasticity of the copolyelectrolyte solutions at high ionic strength differ from the results for solutions of linear amphiphilic macromolecules. This may be due to the presence of styrene monomers in the polymer chain, which promote the formation of aggregates in the surface layer [1,2]. The aggregate formation was observed by the atomic force microscopy. It was also revealed that the shape of the surface elasticity and surface pressure isotherms of spread layers of hydrophobized copolymers depends on the content of hydrophobic segments in the polyelectrolyte chain. For the layers of a polyelectrolyte without styrene groups, a surface phase transition associated with the formation of a dense two-dimensional phase was found.

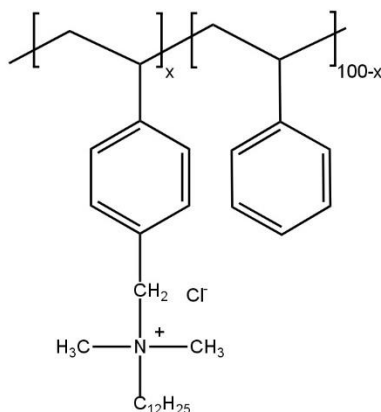

**Scheme 1.** Structural formula of the investigated polyelectrolytes

## References

- [1] *Macromolecules* **2004**, 37, 2519
- [2] *Russian Chemical Reviews* **2015**, 84, 634

## Acknowledgements

This work was supported by the Russian Science Foundation (project No 24-13-00261).

## PRODUCTION OF HYDROGEL INKS FOR FRESH 3D PRINTING BASED ON ESTERIFIED PECTIN

*Koltsova D.M., Zacharova V.A., Karshieva S.Sh.*

NUST MISIS

Student

[dasha.koltsova05@mail.ru](mailto:dasha.koltsova05@mail.ru)

Additive technologies allow using a 3D-printer to create physical objects based on a CAD model by layering the material in order to create a final object with high speed and resolution. 3D-printing with biocompatible materials is actively used in the field of biomedical engineering, biotechnology, pharmaceuticals, including in the field of tissue engineering and regenerative medicine. There are several types of 3D-printing technologies with gels that allow you to obtain personalized medical and biological products: SLA, 2PP, DIW, extrusion. One of the varieties of DIW 3D-printing is fresh printing. A special feature of this technology is the extrusion of hydrogel inks directly into a bath with a supporting gel until they are completely physically or chemically structured. Highly viscous solutions or gels of proteins and polysaccharides are most often used as inks. High-methoxyl pectin (unipectin) is a non-toxic, biodegradable, biocompatible polysaccharide, the degree of esterification of which affects the structure and functional properties of the final product.

The aim is to select the conditions for the formation of a supportive gelatin matrix, to obtain hydrogel inks and functional products based on esterified pectin, as well as to expand technological approaches and conditions for fresh 3D-printing.

The following research objects were selected: aqueous solutions of thermally reversible gelatin protein (2.5-3 wt. %) and UP (2-6 wt. %), as well as solutions of  $\text{CaCl}_2$ , an ion-type crosslinking agent for UP, selected in a molar ratio.

In the course of the work performed, cooling curves of hot gelatin and unipectin solutions were obtained, presented in Arrhenius coordinates, on the basis of which the values of the viscous flow and the gelation process were obtained. The concentration dependences of the gelation temperature and dynamic viscosity and their effect on the structure formation process in obtaining both support and ink have been studied. Concentration dependences of dynamic viscosity indices on pH have been obtained for equiviscid and equiconcentrated solutions. The working concentrations of the hydrogel bath and the unit have been established. The effect of the molar content of calcium chloride on the mechanism and rate of  $\text{Ca}^{2+}$  - induced gelation of unipectin has been studied. The physical and mechanical properties of highly hydrated systems and products based on them were measured using a rupture testing machine (RKM X.1.01 PS, Russia). A complex of biological tests of hydrogel inks for cytocompatibility and hemocompatibility was carried out to assess the possibilities of their use in the field of tissue engineering.

Based on the complex of tests carried out, it was revealed that this approach to the adaptation of hydrogels based on esterified pectin opens up new opportunities for the production of scaffolds on a 3D bioprinter (Fabion, Russia).

## EFFECTIVE DEPOLYMERIZATION OF PET-WASTE VIA CHEMOLYSIS METHODS

*Konnova M.E.<sup>1</sup>, Anwar M.<sup>1</sup>, Dastgir S.<sup>1</sup>*

<sup>1</sup> Qatar Environment and Energy Research Institute, Hamad Bin Khalifa University, Doha, Qatar  
PhD, Research associate  
[mkonnova@hbku.edu.qa](mailto:mkonnova@hbku.edu.qa)

Plastic waste recycling is crucial for the environment, as it can significantly reduce the amount of plastic waste that ends up in landfills or in the oceans. About 20% of the annual plastic production in the world is poly(ethylene terephthalate), i.e. PET. It has been widely applied to produce disposable items due to its superior properties as consumer and industrial plastics such as processability, durability, flexibility, chemical resistance, waterproofing, and lightness [1]. Chemical processing allows the conversion of PET waste into high-quality materials such as purified terephthalic acid and monoethylene glycol. It can also reduce carbon dioxide emissions and energy consumption by 50% compared to the creation of a new PET [2].

The general chemical methods of PET recycling with the degrading agents consist of glycolysis, hydrolysis, methanolysis and aminolysis to yield monomers, i.e., dimethyl terephthalate (DMT), ethylene glycol (EG), terephthalic acid (TPA), and bis(2-hydroxyethyl)terephthalate (BHET). In the absence of a catalyst, the chemolysis reaction is a sluggish process, homogeneous catalysts based on transition metal salts are mainly used as catalysts for chemolysis processes. However, there are several disadvantages, for example catalyst recovery, recyclability, and product purity. In this regard, it is important to develop a catalyst that can easily be separated from the system, highly active and selective, as well as with the possibility of its reuse.

This study involves depolymerization of PET by glycolysis and aminolysis processes. The transition metal-based heterogeneous single-atom catalysts were developed and successfully applied for degradation of PET bottles into monomers. The influence of the contributions of factors such as temperature, reaction time, amount of catalyst and nucleophilic agent have been studied. These catalysts showed high activity and selectivity. In addition, our catalysts showed high conversion under mild conditions, which had previously been obtained only under homogeneous catalysis conditions.

### References

- [1] *Green Chemical Engineering* **2024**, 5, 257
- [2] *Waste Management* **2015**, 46, 557

### Acknowledgements

Qatar National Research Fund (QNRF) is greatly acknowledged for financial support (Project No. NPRP14S-0406-210154).

# POLYMER MATERIALS WITH INCREASED FIRE RESISTANCE BASED ON EPOXY RESINS CONTAINING ARILOXYPHOSPHAZENES

*Konstantinova A.O., Semenova A.Yu., Chistyakov E.M.*

D.I. Mendeleev University of Chemical Technology of Russia, Faculty of Digital Technologies and Chemical Engineering, Moscow, Russia  
Graduate Student  
[nastyia-konstantinowa@bk.ru](mailto:nastyia-konstantinowa@bk.ru)

Epoxy resins are used to produce thermosetting polymers, and are also used: as part of adhesives, protective coatings, glues, coatings in rooms; for repairing cracks, chips and other damage in concrete, metal and other materials; in electronics and electrical engineering for the manufacture of printed circuit boards sealing and protection of electronic components; in the automotive industry to create bumpers, headlight housings; composite materials as a binder, which is reinforced with different types of fibers [1]. Epoxy resins have the following properties: low shrinkage, which is important in injection molding, moisture resistance, high adhesion to various surfaces, thermal stability, and good dielectric parameters.

When curing epoxy resin, a three-dimensional mesh is formed, due to which it is possible to achieve high crosslinking density of the material and obtain a material with excellent physical and mechanical properties [2].

Epoxy resins have low impact strength, crack resistance, and shrinkage, but they are brittle and fire hazardous, so various hardeners are used to eliminate these disadvantages. The best hardeners are phosphazene-based hardeners, which due to cooperative interaction of phosphorus and nitrogen atoms increase fire resistance and form a coke cap that prevents further flame spread [3].

The purpose of this work was to develop a phosphazene-containing hardener based on commercially available cold-curing crosslinking agent isophorondiamine and aryloxyphosphazene, and to combine it with various grades of epoxy resins. As a result of the conducted work the fire-resistant epoxy compositions based on low-viscosity epoxy resins of UP-637 and DER-354 grades and isophorondiamine with different content of amine-containing aryloxyphosphazene were developed. It was found that the introduction of 10, 20, 30 wt.% of modifiers increased the flame retardancy for both grades of resins (Table 1). However, systems with low phosphorus content (less than 1 wt.%) based on UP-637 are more flame retardant compared to DER-354.

Thus, the resulting compositions have potential application in the field of fire-retardant materials.

Table 1. Burning rate of cured compositions, mm /min

Modifier content in the composition, wt. % % %	Resin included in the composition	
	UP-637	DER-354
0	50	17
10	5	15
20	5	15
30	5	10

## References

- [1] Shundo A., Yamamoto S., Tanaka K. Network formation and physical properties of epoxy resins for future practical applications. *JACS Au*. **2022**,2, 1522–1542.
- [2] Bai Y., Wang X., Wu D. Novel cycloliner cyclophosphazene-linked epoxy resin for halogen-free fire resistance: synthesis, characterization, and flammability characteristics. *Industrial. engineering chemistry research*. **2012**. 51, 15064–15074.
- [3] Konstantinova A., Yudaev P., Orlov A., Loban O., Lukashov N., Chistyakov, E. Aryloxyphosphazene-Modified and Graphite-Filled Epoxy Compositions with Reduced Flammability and Electrically Conductive Properties. *Journal of Composites Science*. **2023**,7, 417.

## Acknowledgements

This work was supported by the Russian Science Foundation (project No 22-43-02056), <https://rscf.ru/project/22-43-02056/> (accessed on 9 March 2022).

## DEVELOPMENT OF NOVEL MEMBRANES BASED ON SODIUM ALGINATE MODIFIED BY ZnBIM FOR PERVAPORATION

*Korovina A.M.<sup>1</sup>, Kuzminova A.I.<sup>1</sup>, Dmitrenko M.E.<sup>1</sup>, Dubovenko R.R.<sup>1</sup>, Penkova A.V.<sup>1</sup>*

<sup>1</sup> St. Petersburg State University, St. Petersburg, Russia

Student

[st098339@student.spbu.ru](mailto:st098339@student.spbu.ru)

Recently, membrane technologies have been widely applied in filtration processes, substance separation, water and gas purification as highly efficient and environmentally friendly methods. Pervaporation is considered the most promising technology for the separation of liquid low molecular weight substances (azeotropic mixtures and mixtures of isomers), attracting increasing attention as a renewable energy source. The advantages of pervaporation are simplicity, low cost, acceptable flow and high selectivity compared to other conventional liquid separation methods. Pervaporation has received special attention for dehydration purposes (the selective removal of water from other components, namely, alcohol and solvents). To improve the efficiency of this process, high-performance membrane materials with specific properties are required. Currently, a promising way to enhance the transport properties of polymeric pervaporation membranes is to create mixed matrix membranes (MMMs) by modifying the polymer matrix with an inorganic and/or organic modifier.

In the present work a widely used water-soluble biopolymer, sodium alginate (SA), was chosen for the development of novel dense membranes for the separation of water/isopropanol mixture. Metal-organic framework ZnBIM was used for modification of sodium alginate polymer matrix. The developed membranes have been studied by a number of physico-chemical analysis methods, such as scanning electron microscopy (SEM), atomic force spectroscopy (AFM), Fourier-transform infrared (FTIR) spectroscopy, thermogravimetric analysis (TGA), and nuclear magnetic resonance (NMR) spectroscopy, as well as contact angle measurement and swelling experiments. Transport properties of the developed MMMs were evaluated in pervaporation dehydration of isopropanol in a wide concentration range. For the developed membranes, the positive effect of the introduced modifier on transport characteristics was noted.

### **Acknowledgements**

The authors acknowledge Saint-Petersburg State University for a research project 11602266. The experimental work was facilitated by the equipment from the Resource Centers for Nanotechnology, Magnetic Resonance, Cryogenic Department, Thermogravimetric and Calorimetric Research Centre, Centre for Physical Methods of Surface Investigation, Centre for Innovative Technologies of Composite Nanomaterials, Computing Centre, Chemical Analysis and Materials Research Centre, and Centre "Nanofabrication of Photoactive Materials (Nanophotonics)" at the St. Petersburg State University.

# SYNTHESIS AND CHARACTERIZATION OF NOVEL AMPHIPHILIC COPOLYMERS OF N-VINYL-2-PYRROLIDONE AND OLEIC ACID

*Koziavina D.A.*<sup>1</sup>, *Nechaeva A.M.*<sup>1</sup>, *Belousova V.A.*<sup>1</sup>, *Vnukova A.A.*<sup>2</sup>, *Bagrov, D.V.*<sup>2</sup>, *Mezhuev Y.O.*<sup>1</sup>

<sup>1</sup>Department of Biomaterials, Mendeleyev University of Chemical Technology of Russia, 125047 Moscow, Russia

<sup>2</sup>Department of Bioengineering, Faculty of Biology, Lomonosov Moscow State University, 119234 Moscow, Russia

Graduate student

[dakoziavina@yandex.ru](mailto:dakoziavina@yandex.ru)

Modern drug delivery systems are capable of enhancing the bioavailability of hydrophobic drugs, thereby increasing their efficacy and minimizing toxicity. These properties make drug delivery systems (DDS) one of the key research objects of chemical and pharmaceutical sciences. Amphiphilic polymeric macromolecules based on biocompatible substances are of particular interest for the creation of such systems. [1-2]. Amphiphilic polymeric macromolecules are capable of self-assembly in an aqueous environment, resulting in the formation of aggregates with a hydrophobic core and a hydrophilic shell. This enables them to immobilize a wide range of drugs. Therefore, the synthesis of such compounds represents an important task.

In this study, amphiphilic copolymers of N-vinyl-2-pyrrolidone and oleic acid have been synthesized and characterized. Poly-N-vinyl-2-pyrrolidone is a highly biocompatible, non-immunogenic, low-toxic and water-soluble polymer, rendering it a promising basis for drug delivery systems [3]. Oleic acid, in turn, is a non-toxic natural compound containing a long hydrocarbon radical that imparts hydrophobicity to the copolymer molecule. The structure of the synthesized copolymers was confirmed by <sup>13</sup>C and <sup>1</sup>H NMR spectroscopy, and the aggregation processes of amphiphilic macromolecules were investigated by dynamic light scattering and tensiometry.

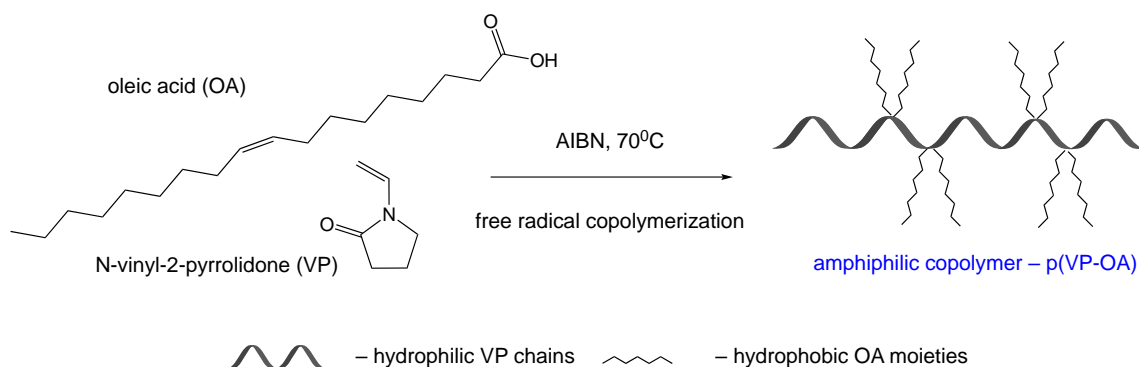

**Scheme 1.** Formation of amphiphilic copolymer of N-vinyl-2-pyrrolidone and oleic acid

The use of dynamic laser light scattering (DLS) and tensiometry methods has demonstrated that amphiphilic copolymers of N-vinyl-2-pyrrolidone and oleic acid undergo self-assembly in aqueous solution to form aggregates with average hydrodynamic diameters in the nanoscale range (120-270 nm). The effect of the monomeric composition on the critical concentration of aggregation and the size of aggregates has been shown. The aggregates exhibited a narrow diameter distribution and a spherical shape, as evidenced by transmission electron microscopy (TEM) data. It has been demonstrated that aggregates of amphiphilic macromolecules are capable of binding the model drug curcumin through hydrophobic interactions. Therefore, the synthesized amphiphilic copolymers are of interest for the development of new drug delivery platforms.

## References

- [1] *Nanomaterials*. **2020**, 10, 1403
- [2] *Drug Delivery Systems: Methods in Molecular Biology*. **2020**, 2059, 55-73
- [3] *Dalton Transactions*. **2015**, 44, 17883-17905.
- [4] *Journal of Controlled Release*. **2020**, 326, 556-598



## DEVELOPMENT AND STUDY OF PERVAPORATION MIXED MATRIX MEMBRANES CARBOXYMETHYL CELLULOSE/ZIF-67

*Kudrina S.A.<sup>1</sup>, Dmitrenko M.E.<sup>1</sup>, Kuzminova A.I.<sup>1</sup>, Polyakov V.A.<sup>2</sup>, Kalmahelidze M.V.<sup>2</sup>, Penkova A.V.<sup>1</sup>*

<sup>1</sup> St. Petersburg State University, St. Petersburg, Russia

<sup>2</sup>The Smart Materials Research Institute, Southern Federal University, Rostov-on-Don, Russia  
Student

[severina.kudrina@mail.ru](mailto:severina.kudrina@mail.ru)

The combination of membrane separation methods is used for a wide range of separation and purification processes in the pharmaceutical, medical, biomedical, food, chemical and petrochemical industries, as well as for wastewater treatment.

The advantages of membrane methods include high productivity, environmental friendliness, energy efficiency, the possibility of carrying out the process at ambient temperature, ease of implementation in production, the possibility of a continuous and automated process and waste-free.

Pervaporation (evaporation through a membrane) is one of the most effective and widespread methods that allows us to economically solve very specific tasks at low temperatures, such as: fractionation of organic mixtures, purification and isolation of products of enzymatic catalysis, separation of azeotropic mixtures and mixtures of isomers. The following advantages can be distinguished:

- High energy efficiency and cost-effectiveness of the process compared to traditional separation methods (distillation, rectification, crystallization);
- Variability of separation characteristics;
- High degree of flexibility regarding the separable mixtures used (multi-purpose systems, different separable mixtures can be separated in one installation);
- Modular, compact design and factory assembly simplify adaptation to the required operating parameters and reduce the time required to install and start the system.

Advanced membrane materials are required for the most efficient separation. There are different ways to improve the properties of porous and non-porous membranes. In the present work, new nonporous membranes with a mixed matrix based on well-known biopolymers (chitosan and carboxymethylcellulose) were developed. The transport and physico-chemical characteristics were improved due to volumetric modification (by introducing graphene oxide) and surface modification (by layering polyelectrolyte). The transport properties of the membranes were evaluated at the first stage of dehydration. The developed membranes have been studied by a number of physico-chemical analysis methods, such as scanning electron microscopy, atomic force microscopy, Fourier transform infrared spectroscopy, nuclear magnetic resonance, thermogravimetric analysis, as well as contact angle measurement and swelling experiments. It was confirmed that the applied modifications significantly change both the physico-chemical and transport properties of the developed non-porous membranes.

### **Acknowledgements**

The research was supported by the Strategic Academic Leadership Program of the Southern Federal University ("Priority 2030"). The experimental work was facilitated by the equipment from the Resource Centers for Nanotechnology, Magnetic Resonance, Thermogravimetric and Calorimetric Research Centre, the Centre for Innovative Technologies of Composite Nanomaterials, Chemical Analysis and Materials Research Centre, and the Centre for "Nanofabrication of Photoactive Materials (Nanophotonics)" at the St. Petersburg State University.

## DEVELOPMENT OF NOVEL SODIUM ALGINATE BASED MEMBRANES MODIFIED WITH Zr-MOFs FOR ISOPROPNOL DEHYDRATION

*Kuzminova A.I.<sup>1</sup>, Stepanova A.S.<sup>1</sup>, Dmitrenko M.E.<sup>1</sup>, Penkova A.V.<sup>1</sup>*

<sup>1</sup> St. Petersburg State University, St. Petersburg, Russia

Assistant

[a.kuzminova@spbu.ru](mailto:a.kuzminova@spbu.ru)

Pervaporation is a dynamically developing membrane technology with high potential for liquid separation in various industries. Its competitive advantage over conventional separation methods lies in its ability to separate azeotropic mixtures, mixtures of thermally unstable components, and isomers. Beyond its high selectivity, pervaporation is environmentally friendly and energy-efficient, utilizing inexpensive and compact equipment. Further development of pervaporation necessitates the search for novel membrane materials with tailored properties. A method of membrane modification has been developed that involves incorporating different modifiers to create mixed matrix membranes (MMMs). The development of MMMs entails modifying the polymer matrix by introducing an inorganic filler, resulting in materials with customized properties. MMMs combine the ease of preparation of polymer membranes with the superior properties of inorganic particles.

In the present work the novel membranes based on biopolymer sodium alginate (SA) were prepared by introducing the three Zr-based metal-organic frameworks (Zr-MOFs): MIL-140A, MIL-140A-AcOH and MIL-140A-AcOH-EDTA into the SA matrix. The improvement of the transport properties of polymer membranes occurs due to the porous structure of the metal-organic frameworks. The developed SA and SA/Zr-MOFs membranes were studied using Fourier-transform infrared spectroscopy, and nuclear magnetic resonance, scanning electron microscopy, atomic force microscopy, X-ray diffraction analysis, thermogravimetric analysis, and swelling experiments. The transport properties of the developed membranes were studied by pervaporation separation of the mixture water/isopropanol mixture. All developed membranes were highly selective for water (more than 99 wt.% water in the permeate). The introduction of Zr-MOFs into the SA matrix leads to significant changes in properties of membranes based on sodium alginate.

### **Acknowledgements**

This work is supported by Scholarship of the President of the Russian Federation CP-2506.2022.1. The experimental work of this study was facilitated by the equipment from the Resource Centre of Geomodel, Chemical Analysis and Materials Research Centre, Centre for X-ray Diffraction Methods, Magnetic Resonance Research Centre, Centre for Innovative Technologies of Composite Nanomaterials, Nanophotonics Centre, Computer Centre, Cryogenic department, Thermogravimetric and Calorimetric Research Centre and the Interdisciplinary Resource Centre for Nanotechnology at the St. Petersburg State University.

# SELF-HEALING POLYURETHANE BLOCK COPOLYMERS WITH CONTROLLED PROPERTIES

*Lokyaeva Z.A.<sup>1,2</sup>, Soboleva J.A.<sup>1</sup>, Storozhuk I. P.<sup>1</sup>*

<sup>1</sup>NTI Center "Digital Materials Science: New Materials and substances" Bauman Moscow State Technical University, Moscow, Russia

<sup>2</sup>N.N. Semenov Federal Research Center for Chemical Physics, Moscow, Russia  
Postgraduate  
[lokyaeva@bmstu.ru](mailto:lokyaeva@bmstu.ru)

Polyurethane block copolymers consist of two types of blocks: polar rigid and non-polar flexible. As a result of the interaction of these blocks, a highly organized structure can be formed, consisting of domains of hard blocks distributed in the flexible block phase, or a poorly ordered structure with a chaotic distribution of hard blocks in the flexible phase [1]. By varying the ratio of blocks and their chemical structure, it is possible to create materials with various applications [2]. However, along with a valuable set of properties, they also have some disadvantages, including the formation of defects during their operation, which significantly reduces the service life of products based on them.

Thus, an urgent task is to create self-healing polyurethane block copolymers for various applications [3]. In this regard, we have obtained polyurethane block copolymers with the ability to self-heal with block ratios of 40:60, 50:50 and 60:40 wt. % based on polytetramethylene oxide with a molecular weight of 1000 Da, adducts of the Diels-Alder reaction capable of implementing the self-healing process, toluene diisocyanate and 1,4-butanediol (Fig. 1).

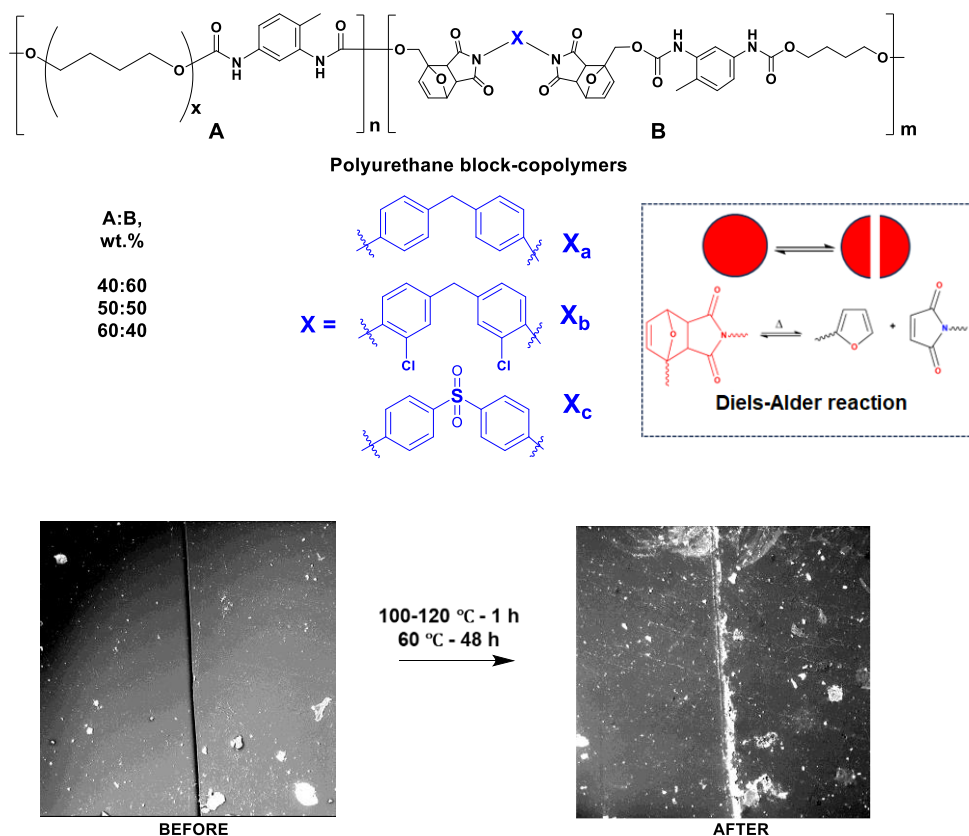

**Figure 1.** Structure and self-healing properties of obtained polyurethane block-copolymers.

## References

- [1] *Rapra Technology Limited 2008.*
- [2] *Polymer (Guildf) 2004, 45, 2249.*
- [3] *Soft Matter 2008, 4, 400.*

## Acknowledgements

This work was carried out within the framework of the program of state support for the centers of the National Technology Initiative (NTI) on the basis of educational institutions of higher education and scientific organizations (NTI Center "Digital Materials Science: New Materials and Substances" Bauman Moscow State Technical University).

# EFFECTS OF THE MODIFICATION WITH ZIRCONIUM HYDROGEN PHOSPHATE ON THE PROPERTIES OF PERFLUORINATED MEMBRANES

*Loza J.S.<sup>1</sup>, Loza N.V.<sup>1</sup>, Falina I.V.<sup>1</sup>*

Kuban State University

Student

[julialoza@list.ru](mailto:julialoza@list.ru)

Perfluorinated membranes are used in the membrane-electrode assemblies of hydrogen-air fuel cells. However, their conductivity under the conditions of high temperature and low humidity are unsatisfactory. Insertion of hydrophilic dopants, such as zirconium hydrogen phosphate, into the membrane matrix improves the performance [1].

The purpose of this work was to obtain composite based on zirconium phosphate and perfluorinated homogeneous membrane MF-4SK produced by Plastpolymer OJSC (St. Petersburg, Russia), study its physical-chemical and transport properties and evaluate the impact of each stage of modification on the resulting material.

The modification was carried out by swelling-filling method. The membrane after oxidative-thermal preparation (OTP) [2] was exposed to water-ethanol mixture for 1 hour,  $60\pm 5$  °C. After ethanol treatment the membrane enters an expanded state, which is described in [3]. Then, the membrane was held in 0.1 M  $ZrOCl_2$  for 9 hours, 70-85 °C and entered zirconyl-ion form. Saturation with the precursor is complicated by the relatively large size of the hydrated zirconyl-ion, which is why the membrane was previously conditioned with water-ethanol mixture. Lastly, it was exposed to 1 M  $H_3PO_4$  for 8 hours,  $70\pm 10$  °C. At the last stage, zirconium hydrogen phosphate nanoparticles formed in the porous space of the membrane. Sample MF-4SK<sub>a</sub> underwent all of the above operations, apart from exposure to  $ZrOCl_2$  solution. Modified MF-4SK/ZrHP sample was compared to MF-4SK<sub>a</sub> and the initial MF-4SK after OTP to track the changes in its properties.

For all three samples, their water content, ion-exchange capacity, thickness, diffusion permeability, specific conductivity and current-voltage characteristics in HCl solutions were determined. Microheterogeneous model [4] parameters were calculated based on the concentration dependences of specific conductivity and diffusion permeability.

The water-ethanol treatment had the key influence on the structural changes of the resulting membrane. MF-4SK<sub>a</sub> has the highest water content, conductivity, diffusion permeability, proportion of internal solution ( $f_2$ ), counter- and co-ion mobility. The introduction of ZrHP mitigates aforementioned effects, except for co-ion mobility, due to modifier filling the porous space of the expanded membrane. Both MF-4SK<sub>a</sub> and MF-4SK/ZrHP has a higher thickness due to wedging effect of ethanol on the polymer chains of the membrane, which leads to higher electrical resistance in membrane-electrode assembly. However, the resulting composite has a significantly higher water content and conductivity, compared to the initial membrane, which are positive effects.

Further changes to the modification technique are discussed due to negative effect of the water-ethanol treatment on the properties of the composite.

## References

- [1] *Membranes* **2023**, 13, 721
- [2] *J. Membr. Sci.*, **2002**, 209, 509.
- [3] *Adv. Colloid Interface Sci.* **2015**, 222, 425-435.
- [4] *Adv. Colloid Interface Sci.*, **2008**, 139, 3-28.

## Acknowledgements

This work was supported by the Russian Science Foundation and Kuban Science Foundation (project No 22-19-20101).

## ANTI-CORROSION SEALANT TO PREVENT CREVICE CORROSION OF MATING MATERIALS

*Makushchenko I.S.<sup>1</sup>, Kozlov I.A.<sup>1</sup>*

<sup>1</sup> Federal State Unitary Enterprise «All-Russian Scientific-Research Institute of Aviation Materials» of National Research Center «Kurchatov Institute», Moscow, Russia;

PhD Student

[lab28@viam.ru](mailto:lab28@viam.ru)

The work is aimed at studying the anti-corrosion properties of polysulfide sealant containing corrosion inhibitors.

To analyze the properties, 4 variants of polysulfide sealant were made: without a corrosion inhibitor, with zinc phosphate, with zinc tetraoxochromate, with cyclohexylamine chromate. Corrosion inhibitors were introduced into the sealant in amounts of 0.1, 0.5, 1 and 2% of the total composition of the components. The sealant was vulcanized by mixing a thiokol-based sealing paste and a MnO<sub>2</sub>-based vulcanizing paste, followed by a “hot” soak at 25°C and 50% humidity for 24 hours, then 70°C and 10% humidity for 24 hours.

To evaluate the anti-corrosion properties, samples of the sealant were applied to a contact metal pair consisting of an aluminum alloy and steel, followed by exposure for 14 days in a salt fog chamber.



**Scheme 1.** Samples after exposure to a salt fog chamber

Based on test results, it was found that polysulfide sealant containing cyclohexylamine chromate provides the best anti-corrosion protection. With zinc phosphate, the formation of small pockets of corrosion has been observed. The worst performers were sealants without an inhibitor and with zinc tetraoxochromate.

In addition to the main corrosion tests, an additional study was conducted to change the mass of the sealant with inhibitors in distilled water for 90 days. Based on the results of the research, it was found that the sealant with zinc phosphate has the lowest moisture absorption. The greatest increase in weight was observed for the sealant without a corrosion inhibitor.

Based on these results, it can be assumed that the sealant containing zinc phosphate acts as a barrier. While a sealant containing chromium, absorbing water, ensures that the inhibitor reaches the surface. Thus, when the inhibitor reaches the metal surface, a protective barrier can be formed that prevents the formation of corrosion.

### References

[1] *Materialy Vserossiiskoi nauchnotekhnicheskoi konferentsii Fundamental'nye i prikladnye issledovaniya v oblasti uplotnitel'nykh, germetiziruyushchikh i ogneplozashchitnykh materialov (Proc. All-Russ. Sci.-Tech.Conf. on Fundamental and Applied Studies in the Area of Sealing and Fire- and Heat-Protective Materials)*, Pavlyuk, B.F., Bryk, Ya.A., Chaikun, A.M., Shein, E.A., and Zakrzhevskaya, M.S., Eds., Moscow: VIAM, 2019, pp. 24–34.

[2] *Rossina, N.G., Popov, N.A., and Zhilyakova, M.A., Korroziya i zashchita metallov. Uchebnometodicheskoe posobie (Corrosion and Protection of Metals: Textbook)*, Ekaterinburg: Ural. Gos. Univ., 2019, vol. 1.

# TRIBOELECTRIC NANOGENERATORS DIFFERENT SHAPES BASED ON THE GALLIUM ALLOYS FOR ENERGY HARVESTING

*Malandina M.A.<sup>1</sup>, Mikhaylova P. A.<sup>1</sup>, Falchevskay A.S<sup>1</sup>*

<sup>1</sup>ITMO University, Saint Petersburg, Russia

Master student

[yatsuk@scamt-itmo.ru](mailto:yatsuk@scamt-itmo.ru)

The development of innovative energy harvesting technologies has become increasingly important in the quest for sustainable and renewable energy sources. One such innovative advancement is the triboelectric nanogenerator (TENG) based on liquid metal alloys. This contemporary technology is based on the power of friction and contact electrification to generate electricity [1]. It's offering a promising solution for powering small-scale electronic devices and sensors.

Composites materials based on liquid metal alloys and polymers offer a successful combination of properties that make them ideal for a wide range of applications. Principal advantages of using liquid metal alloys in combination with polymers is their typical flexibility and stretchability. This flexibility allows the composites to conform to different shapes and surfaces, making them suitable for applications where solid materials would be impractical. The compatibility between polydimethylsiloxane (PDMS) and gallium alloy further enhances the performance and durability of the composite material. PDMS is known for its excellent adhesion properties and chemical resistance, making it an ideal matrix material for encapsulating and stabilizing liquid metal droplets. This compatibility ensures good integration between the two components, resulting in a binder and strong composite structure. The main layer of a triboelectric nanogenerator is typically composed of the eutectic alloy GaInSn (Galinstan) or a paste mixture of GaInSnCu, which enhances adhesion with polymers [2]. By optimizing the adhesion of the alloy with polymers, the composite material ensures efficient energy conversion and improved performance in a wide range of environmental conditions.

In the field of energy harvesting technologies, we have developed TENG of various shapes, including fibers and flat structures, which have become an important area of research. Structure in TENG is a significant factor for its performance and efficiency in converting mechanical energy into electrical energy. One of the key reasons highlighting the importances of structure is its capacitance. This parameter determines the system's ability to keep the charge generated during friction or contacting of materials. Capacitance in a TENG is typically defined as the ratio of accumulated charge to the potential difference between the electrodes. High capacitance allows for the accumulation of a larger amount of charge and provides more efficient energy storage. To increase the capacitance in TENG we have chosen to develop a fiber with a core structure like that of a supercapacitor. This innovative design aims to significantly enhance the energy storage capabilities of the nanogenerator, allowing for improved efficiency and performance in energy harvesting applications. As Regards of flat triboelectric nanogenerator, our developed method for manufacturing is simple and optimized to minimize time consumption, making it respectable for special attention. This simplified approach provides efficient production of the nanogenerators, allowing for quick and cost-effective scaling of the technology. By focusing on ease of fabrication, we aim to accelerate the adoption and integration of triboelectric nanogenerators in various energy harvesting applications. In the course of comprehensive performance studies, it has been demonstrated that these TENG are great performance indicators: the output voltage reaches 20 V, and the maximum current reaches 3 mA. The impressive electrical properties of these devices underscore their capability to efficiently power a wide range of applications and devices, making them ideal for integration into practical systems that promote sustainable energy production and utilization.

## References

- [1] *Nanomaterials* **2022**, *12*, 1366
- [2] *Nano Energy* **2022**, *101*, 107582

## Acknowledgements

This work was supported by the Russian Science Foundation (project No 24-23-00270) and research topic No 623102 "Adaptable autonomous flexible devices for health monitoring".

## INVESTIGATION OF THE PERMEABILITY OF PAINT COATINGS FILLED WITH BASALT PRODUCTION WASTE

*Maliavina Y.M.<sup>1</sup>, Silaeva A.A.<sup>1</sup>, Romakhina T.R.<sup>1</sup>, Kukushkina E.A.<sup>1</sup>, Snimshchikova Y.O.<sup>1</sup>, Rodnikov D.T.<sup>1</sup>*

<sup>1</sup>D.I. Mendeleev University of Chemical Technology of Russia, Moscow, Russia

PhD student

[jonkey.moa@yandex.ru](mailto:jonkey.moa@yandex.ru)

The protection of large-sized metal structures operated under atmospheric conditions is mainly carried out using protective paint and varnish materials [1]. Such compositions should prevent the diffusion of aggressive media, in particular water, to the metal substrate in order to protect it from corrosion. Thus, the permeability of paint coatings is one of the key factors determining the protective properties of such coatings [2].

In addition to the main components of the paint and varnish material, such as a film-forming substance and pigments, fillers are introduced into the composition of such materials in order to reduce the cost of the composition. Recently, waste from various industries has been increasingly used as fillers. The use of such waste is aimed not only at reducing the harmful effects on the environment, but also at giving the paint composition special properties [3].

This work is devoted to the study of the effect of mineral filler, waste from basalt production, on the permeability of paint coatings. The results of the conducted studies show that the introduction of the filler under study does not lead to a decrease in the physical and mechanical characteristics of the paintwork, there is an improvement in protective properties with a decrease in the permeability of coatings based on polyurethane and epoxy based with an optimal ratio of fillers. Microtalk, zinc phosphate and barium sulfate were also present in the compositions, which were partially replaced by the filler under study. Previously, the effect of another filler of a similar nature on the permeability of polyurethane and epoxy coatings was investigated. The results of the study showed the influence of basalt filler on the curing processes, leading to an increase in the degree of curing and a decrease in the permeability of coatings. The purpose of this work was to confirm the results obtained by examining another basalt filler.

To assess the possible effect of basalt filler on the permeability of the paintwork, the acid-base properties of its surface were evaluated by potentiometric titration. Determination of the content of acid-base centers is based on the use of the method of potentiometric titration of the suspension of the filler under study with aqueous solutions of p-toluene sulfonic acid and caustic potassium. Since the operation of the pH meter is based on measuring the electromotive force created by the electrochemical part of the device (electrodes), titration, in which a change in the pH of the suspension is recorded when a titrant is added, refers to potentiometric methods. Titration results showed the presence of the main centers on the filler surface in the amount of 97,28 mmol/g. The effect of the basalt filler content on the degree of curing of coatings by the gel-sol fraction method was also studied. The method for determining the degree of curing of coatings based on the content of the gel-sol fraction in the film is based on the ability of the soluble part of the films (sol fraction) to be washed out with a solvent during extraction in a Soxlet apparatus. The method consists in the quantitative determination of a sol fraction that is not bound into a three-dimensional polymer grid (gel fraction). Based on the results obtained, it can be concluded that the introduction of a basalt filler affects the degree of curing of coatings, which, in turn, may affect permeability.

### References

[1] *Drinberg, A.S., Itsko E.F., Kalinskaya T.V. Antikorrosionnye gruntovki [Anticorrosive primers]. Saint Petersburg, NIPROINS LKM and P with OP, 2006, 168 p.*

[2] *Reitlinger S.A. Pronitsaemost' polimernykh materialov [Permeability of polymer materials]. Moscow, Chemistry, 1974, 270 p.*

[3] *Kovrizhkina N.A., Kuznetsova V.A., Silaeva A.A., Marchenko S.A. Sposoby uluchsheniya svoistv lakokrasochnykh pokrytii s pomoshchyu vvedeniya razlichnykh napolnitelei (obzor) [Ways to improve the properties of paint coatings by introducing various fillers] (review). Aviatsyonnye materialy i tekhnologii, 2019, no. 4 (57), pp. 41-48.*

## EPOXY VITRIMERS WITH A RECONFIGURABLE POLYMER MATRIX

*Manapova E.E.*

Tomsk Polytechnic University, Tomsk, Russia

Student

[eem20@tpu.ru](mailto:eem20@tpu.ru)

Epoxy vitrimers are a class of polymeric materials integrating the advantage of thermosets and thermoplastic whose topology can be changed and controlled by the transesterification reaction. In this case, there is no decomposition of the polymer chains or a decrease in the integrity of the polymer. As a result, it is possible to obtain new “smart” materials, products from which can be reprocessed, repaired, and operational defects that arise in them can be “healed,” connected through “smart welding,” etc. [1]. The purpose of this work is to obtain network thermosets with a tunable polymer matrix based on an aromatic epoxy resin - the diepoxy monomer of bisphenol A diglycidyl ether (DGEBA).

In the preparation of epoxy vitrimers, DGEBA was used as a monomer, as well as dicarboxylic acid anhydrides and dicarboxylic acids as crosslinking agents for curing reactions. To accelerate transesterification reactions, an interchain exchange catalyst based on metal salts was used [2]. The scheme for the synthesis of epoxy vitrimers and possible changes in the structure of macromolecules and demonstrating shape memory and reconfiguration are shown in Figure 1.

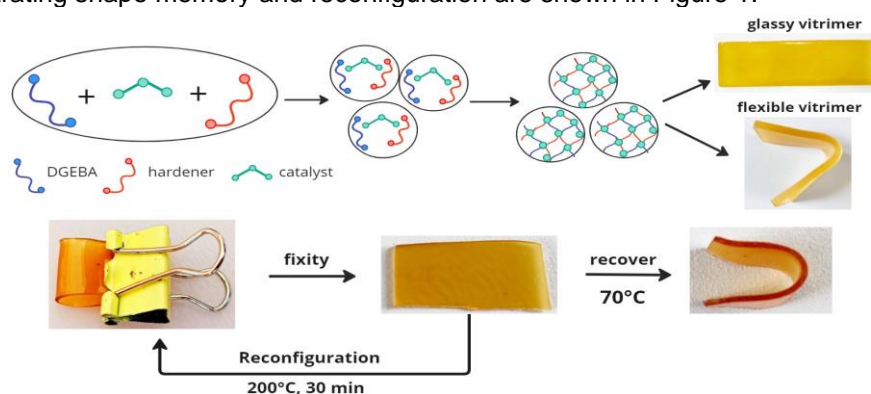

**Figure 1.** a) Scheme of the synthesis of vitrimers and possible changes in the structure of macromolecules. b) Qualitative study demonstrating vitrimer shape memory.

To obtain epoxy vitrimers, an interchain exchange catalyst and a hardener were added to DGEBA, the resulting mixture was stirred and heated in a time interval from 5 to 60 minutes at a temperature from 50 to 170 °C. The ratio of DGEBA to hardener varied from 2:1 to 1:2.5, and the amount of catalyst varied from 1 to 7 %. The prepared reaction mixture was poured into a PTFE mold and kept in a muffle furnace at a temperature of 120–200 °C for 1.5–4 hours. As a result of selecting the catalyst, initial components and reaction conditions, it is possible to obtain both high-strength and highly elastic materials with improved strength characteristics. The resulting epoxy vitrimers were analyzed using IR spectroscopy. The disappearance of the characteristic absorption band of the DGEBA at 915  $\text{cm}^{-1}$  indicates complete consumption of the epoxy group. The appearance of new bands in the spectra of vitrimers (3422 and 1733  $\text{cm}^{-1}$ ) is explained by the formation of hydroxyl and carbonyl groups as a result of the reaction [3]. The strength characteristics of the obtained samples (relative elongation 120–180 %, elastic modulus 2.97–6.95 MPa) were obtained on a GOTECH AI-7000-M universal testing machine. Tests of samples for shape memory were carried out in the temperature range from 150 to 200 °C. The transesterification reaction is activated by temperature, and the ester and hydroxyl groups react with each other with the help of a catalyst, forming a new ester group and a new hydroxyl group, which will continue to react with other hydroxyl or ester groups until is achieved dynamic equilibrium. When cooled, the new geometric configuration is maintained (Fig.1b). The resulting epoxy vitrimers with reconfigurable shape memory will greatly simplify the processing of complex permanent shapes and expand the applications of shape memory polymers. In addition, they have high strength characteristics, which allows them to be used in various areas of modern industry.

### References:

- [1] *Polymer*. **2020**, 197, 122514
- [2] *Progress in Materials Science*. **2021**, 120, 100710
- [3] *Materials* **2021**, 14, 919



# TRANSPORT AND MECHANICAL PROPERTIES OF THE MF-4SK PERFLUORINATED MEMBRANES WITH VARYING CONTENTS OF INERT FLUOROPOLYMER AND ZIRCONIUM HYDROGEN PHOSPHATE

*Meshcheryakova E.E.<sup>1</sup>, Falina I.V.<sup>1</sup>, Kononenko N.A.<sup>1</sup>, Timofeev S.V.<sup>2</sup>*

<sup>1</sup>Kuban State University, Department of Physical Chemistry, Krasnodar, Russia

<sup>2</sup>JSC «Plastpolymer», St. Petersburg, Russia

Employee, master degree

[katerina6327095@gmail.com](mailto:katerina6327095@gmail.com)

There are several requirements for membranes used in a proton exchange membrane fuel cell. They are mechanical strength, high proton conductivity, low gas permeability and thermal and chemical stability [1]. It is possible to achieve a compromise of these characteristics by adding inert fluorocarbon polymer and zirconium hydrogen phosphate (ZrHP) in membranes structure [2, 3]. The purpose of the present study is to investigate the effect of adding the inert fluoropolymer and zirconium hydrogen phosphate to the perfluorinated membranes on their transport and mechanical properties.

The objects of study are the series of experimental cation exchange perfluorinated membranes MF-4SK with various content inert fluorocarbon polymer polyvinylidene fluoride (PVDF) from 15 to 25 % and zirconium hydrogen phosphate (ZrHP) from 4 to 8%. The membrane samples were obtained by casting. The diffusion permeability was studied for the membranes in free-standing state. The conductivity of the membranes was measured in temperature range from 40 to 90 °C and RH=40 %. The dynamic mechanical analysis of air-dry samples was performed by a tension testing machine with an extension rate of 5 mm/min at room temperature and humidity.

The diffusion permeability of samples containing 4-8% ZrHP decreases with an increase in the content of inert fluorocarbon polymer in the membrane structure. However, varying the content of the inert fluoropolymer PVDF in the pure membranes from 15 to 25% does not lead to a significant change in diffusion permeability. The presence of ZrHP leads to the increase in membrane conductivity and reduction of activation energy.

The addition of PVDF to the membrane leads to an improvement in strength and elongation. However, an increase in the content of PVDF in the membrane leads to a decrease in water content. The introduction of ZrHP into the membrane makes it possible, while maintaining increased strength, to ensure high water content values, conductivity and, possibly, a noticeable decrease in gas permeability, which will improve the operational characteristics of fuel cells.

## References

- [1] *Membranes*. **2022**, 12 (10), 935
- [2] *Colloid and Polymer Science* **2019**, 297, 741
- [3] *Int. J. Hydrogen Energy* **2019**, 44, 28919

## Acknowledgements

The study was supported by the Russian Science Foundation and Kuban Science Foundation (project No. 22-19-20101), <https://rscf.ru/en/project/22-19-20101/>.

# APPLICATION OF LIQUID GaInSn ALLOY IN THE DEVELOPMENT OF FLEXIBLE SENSORS AND TRIBOELECTRIC NANOGENERATORS FOR HEALTH MONITORING

*Mikhailova P.A.<sup>1</sup>, Malandina M.A.<sup>1</sup> Falchevskaya A.S.<sup>1</sup>*

<sup>1</sup> ITMO University, St. Petersburg, Russia

Student, 1 master degree course

[mikhaylova@scamt-itmo.ru](mailto:mikhaylova@scamt-itmo.ru)

In recent years (2021 - 2024), the global market of flexible electronics is gradually developing, and by 2032 its sharp increase is expected [1]. Due to its advantages (easy and cheap manufacturing processes, flexibility and stretching, compactness) flexible wearable devices may be used in the field of medicine to measure and monitor the health of the human body [2]. At present in the Russian Federation nanocarbon conductors, aluminum, copper and gold are often used in the field of flexible wearable electronics. We suggest replacing them with a gallium alloy GaInSn, because it has many advantages that allow it to be used in this field: biocompatibility, close Young's modulus to the polymer, deformation resistance, optimal electro- and thermal conductivity, wettability and low melting point (-19 °C).

In this work, we present a development of two components of wearable electronics for autonomous health monitoring: resistive strain sensors and triboelectric nanogenerators (TENG). For preparation, we took polydimethylsiloxane polymer (SYLGARD 184 Silicone Elastomer Kit) as a substrate and dielectric and GaInSn (Ga68,5%-In21,5%-Sn10%) alloy as a conductive layer. To analyze sensors and TENGs for efficiency and sensitivity, we used a Precision Source/Measure Unit Tonghui TH 1991B and a Universal Test Machine Ametek LS1 to test the sensors for compression and tension. The principle of strain sensor work is based on increasing the resistance of the conductor in response to its compression and stretching (the resistance is directly proportional to the length of the conductor and inversely to its cross-sectional area). To prepare the sensors, we applied a pattern of the future conductor onto a polymer substrate using a laser engraver LaserMan flying bear and sprayed the alloy using an airbrush JAS 1202. Using a laser engraver allows to vary conductor parameters such as depth/height (number of laser passes) and conductor length, which allows you to customize the sensitivity of the sensor. TENGs are devices that accumulate and convert mechanical energy into electrical energy. The mechanism of its work is based on the principles of electrostatic induction and electrification. They are a prospective source of autonomous power supply for wearable electronics. In our work, we have prepared vertical contact-separation TENGs using spincoater POLOS. The following work was taken as a basis for preparation [3]. Produced TENG has a "sandwich"-structure: between two layers of dielectric (PDMS polymer) there is a layer of GaInSn alloy. Testing the sensors for change in resistance showed an adequate signal in response to compression in the force range of from 0,1 to 50 N. Variation the conductor parameters (length and height of the cross-section area) gave the sensors with different sensitivity, which was recorded by the Precision Source/Measure Unit. The produced TENGs also demonstrated adequate results. The characteristics generated by TENGs with a diameter of D=75 mm were enough to ignite a diode with an operating voltage ~2,0 - 3,0 V and a current ~20 mA, which corresponds to the voltage for the microcontroller.

In conclusion, we have developed autonomous components of the electric chain: strain sensors with different sensitivity and vertical contact-separation TENGs, that can be used for health monitoring devices (smart insoles, devices for blood pressure and pulse monitoring).

## References

- [1] *Semiconductor & Electronics Market Research Report*. - URL: <https://www.fortunebusinessinsights.com/flexible-electronics-market-109105>
- [2] *Electronic Materials Letters*. **2023**, 19, 325–341
- [3] *Nanomaterials* **2023**, 13, 1290

## Acknowledgements

This work was supported by the Russian Science Foundation (project No 24-23-00270) and research topic No 623102 "Adaptable autonomous flexible devices for health monitoring".

## DEVELOPMENT AND STUDY OF PERVAPORATION MEMBRANES FROM POLYELECTROLYTE COMPLEX MODIFIED WITH GRAPHENE OXIDE

*Mikhailovskaya O.A., Kuzminova A.I., Dubovenko R.R., Penkova A.V., Dmitrenko M.E.*

St. Petersburg State University, 7/9 Universitetskaya nab., St. Petersburg 199034, Russia

Student 4th year

[mihajlovskaya.olga.1@yandex.ru](mailto:mihajlovskaya.olga.1@yandex.ru)

### Introduction

Nowadays, membrane technologies are considered as a sustainable alternative to traditional separation methods. Pervaporation has emerged as a promising membrane method for the separation of liquid mixtures with low molecular weight substances and thereby for the dehydration of bioalcohols, which are actively used as a renewable energy source. The advancement of pervaporation technology requires the development of novel materials for the creation of effective membranes with tailored properties. In this context, polyelectrolytes have attracted considerable interest as potential membrane materials. Membranes from polyelectrolyte complexes (PEC), consisting of oppositely charged polyelectrolytes, offer optimal functionality and improved selective water permeability attributed to the "salting-out effect" towards organic substances. Furthermore, the incorporation of nanoparticles into PEC membranes, namely, the creation of mixed matrix membranes, holds promise for enhancing membrane performance.

In this study, novel effective pervaporation membranes based on PEC, consisting of polyethylenimine (PEI) and sodium alginate (SA) and modified with graphene oxide (GO), were developed for enhanced dehydration of bioalcohols. The effect of varying the PEI/SA ratio and GO concentration in the PEC matrix on membrane characteristics was assessed. To improve the performance of dense PEC and PEC/GO membranes, supported membranes were created by deposition of a thin selective layer from the PEC and PEC/GO composite onto a developed porous polyacrylonitrile (PAN) substrate. To enhance the stability of these supported membranes in dilute solutions, chemical cross-linking with glutaraldehyde and H<sub>2</sub>SO<sub>4</sub> was carried out. Microscopic and spectroscopic methods were used to study the structure of the composites and membranes from them. Physicochemical properties of membranes were investigated by measurements of water contact angles and thermogravimetric analysis. Transport properties of dense and supported membranes were evaluated in pervaporation dehydration of ethanol in a wide concentration range (4-90 wt.% water). It was demonstrated that the cross-linked supported membrane with a thin selective layer from PEC (50/50 ratio of SA/PEI) modified with 2.5 wt.% GO exhibited a two-fold increase in permeation flux and improved selectivity compared to the pristine SA membrane.

### Acknowledgements

This research was funded by Russian Science Foundation, grant number 23-73-01070, <https://rscf.ru/en/project/23-73-01070/>. The experimental work was facilitated by the equipment from the Resource Centers for Nanotechnology, Magnetic Resonance, Cryogenic Department, Thermogravimetric and Calorimetric Research Centre, Computing Centre, Chemical Analysis and Materials Research Centre, and Centre "Nanofabrication of Photoactive Materials (Nanophotonics)" at the St. Petersburg State University.

## DEVELOPMENT AND CHARACTERISATION OF NOVEL COMPOSITE MEMBRANES BASED ON CARBOXYMETHYL CELLULOSE/MOF FOR PERVAPORATION

*Mikulan A.I.<sup>1</sup>, Kuzminova A.I.<sup>1</sup>, Dmitrenko M.E.<sup>1</sup>, Dubovenko R.R.<sup>1</sup>, Penkova A.V.<sup>1</sup>*

<sup>1</sup>Saint Petersburg State University, Saint-Petersburg, Russia

Student

[st097675@student.spbu.ru](mailto:st097675@student.spbu.ru)

Membrane technologies are rapidly developing, becoming more and more in demand in various industries. Their advantages over traditional separation methods are obvious: membrane processes consume less energy, reducing costs and making production more economical, do not require the use of hazardous reagents and organic solvents, which reduces the negative impact on the environment. The membranes are capable of separating substances with high selectivity, which makes it possible to obtain high-quality products. One of the promising directions in membrane technology is pervaporation. Using pervaporation, it is possible to separate mixtures of isomers, azeotropic mixtures and thermally unstable mixtures. The rapid development of pervaporation technology stimulates the search for new high-performance membrane materials. Special attention is paid to mixed matrix membranes (MMMs). MMMs are composite materials in which the polymer matrix is modified with organic and/or inorganic fillers. MMMs may have higher permeability, transport properties and selectivity compared to pure polymer membranes. The addition of modifiers allows you to adjust the characteristics of the membranes and create a unique material by combining the properties of the components. Further development of this area will allow solving many problems in various industries, as well as making production more environmentally friendly and energy efficient.

In this work, it was possible to create a novel membrane for the pervaporation dehydration. These membranes are made on the basis of carboxymethyl cellulose (CMC), into the structure of which the metal-organic framework (MOF) was introduced. The production of such hybrid membranes with the inclusion of metal-organic frameworks as significantly improved their transport characteristics compared to unmodified membranes from CMC. This is achieved by changing the structure and properties of the polymer matrix when introducing MOF particles. To study in detail, the structural changes occurring in modified membranes, such analytical methods as scanning electron microscopy, atomic force microscopy, infrared Fourier spectroscopy, nuclear magnetic resonance, thermogravimetric analysis, swelling experiments and wetting edge angle measurement were used. The transport properties of the resulting hybrid membranes were investigated during the initial separation of the binary and multicomponent mixtures. The results showed that modified CMC-based membranes with the inclusion of MOF have significantly higher permeability compared to the pristine unmodified CMC membranes. This indicates the prospects of using such hybrid materials to create highly efficient membranes for the processes of initial separation of liquid mixtures.

### **Acknowledgements**

This work was supported by the Russian Science Foundation grant № 20-79-10064, <https://rscf.ru/project/20-79-10064/>. The experimental work of this study was facilitated by the equipment from the Resource Centre of Geomodel, Chemical Analysis and Materials Research Centre, Centre for X-ray Diffraction Methods, Magnetic Resonance Research Centre, Centre for Innovative Technologies of Composite Nanomaterials, Nanophotonics Centre, Computer Centre, Cryogenic department, Thermogravimetric and Calorimetric Research Centre and the Interdisciplinary Resource Centre for Nanotechnology at the St. Petersburg State University.

## NEW COPOLYCARBAZOLES WITH DELAYED FLUORESCENCE

*Mitroshin A.M.*<sup>1</sup>, *Miltsov S.A.*<sup>1</sup>, *Litvinova L.S.*<sup>1</sup>, *Smyslov R. Yu.*<sup>1</sup>, *Yakimansky A.V.*<sup>1</sup>

<sup>1</sup> Institute of Macromolecular Compounds of the Russian Academy of Sciences, Russia  
Postgraduate Student  
[amitroshin51@gmail.com](mailto:amitroshin51@gmail.com)

Polycarbazole presents a versatile platform for covalently bonding with luminophores exhibiting thermally activated delayed fluorescence (TADF), owing to its high-energy backbone triplet state [1]. However, when employing blue luminophores, it becomes crucial to effectively localize the excited state within the backbone. Recently it was demonstrated that modification of the carbazole unit with methyl-substituted phenylene could lead to excellent conjugation disruption between a TADF moiety and a backbone, thereby preserving TADF's optical properties [2,3]. These polymers necessitate alkyl groups in the TADF moiety to ensure solubility in toluene or chlorobenzene, commonly utilized in subsequent device fabrication steps. However, incorporation of long alkyl groups into the TADF moiety can pose challenges.

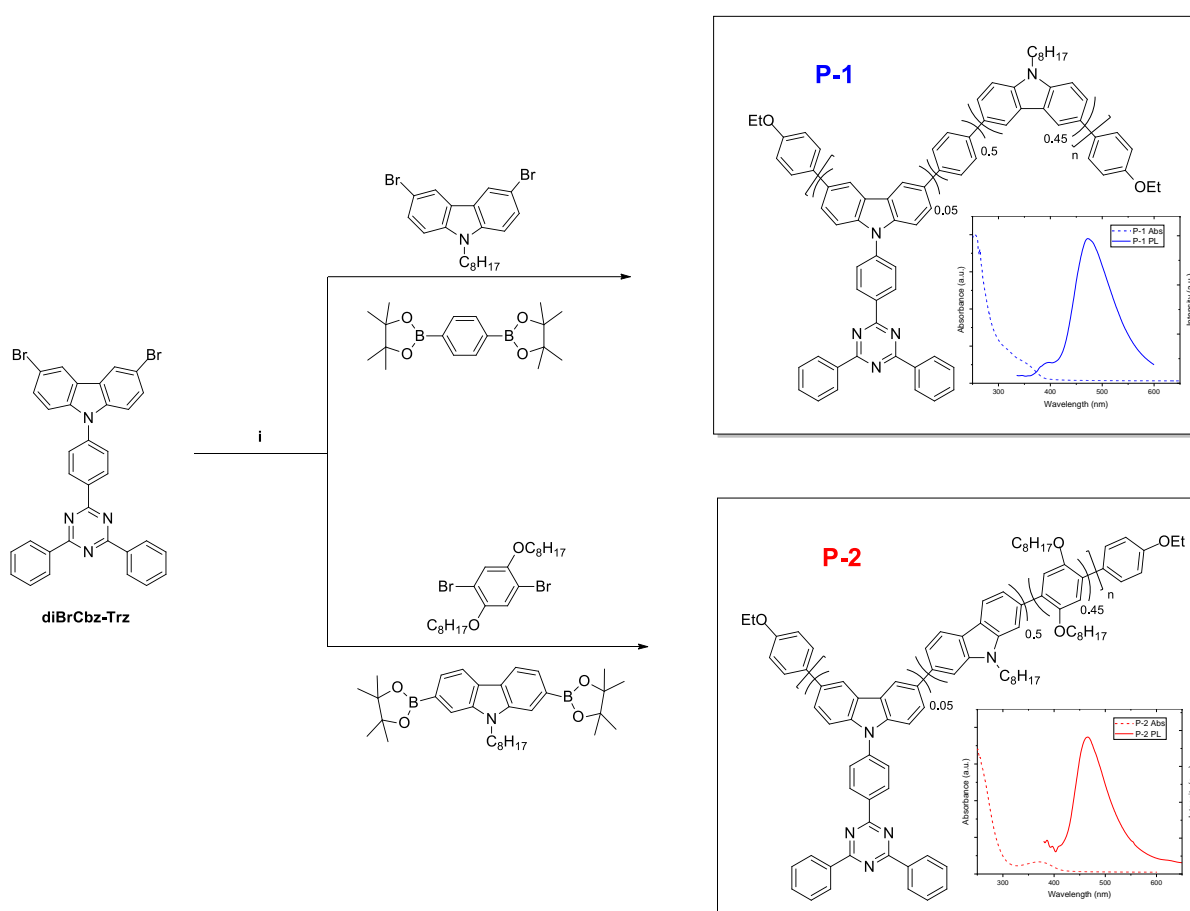

**Scheme 1.** Synthesis of **P-1** and **P-2** and optical properties of solid films: (i) Pd(PPh<sub>3</sub>)<sub>4</sub>, K<sub>2</sub>CO<sub>3</sub>, Aliquat 336, toluene/water, 100 °C.

In the present study, **P-1** and **P-2** polymers were synthesized through Suzuki polycondensation, incorporating **diBrCbz-Trz** as the TADF moiety. To address solubility concerns, we developed a novel phenylene unit with two octyloxy groups, affording excellent solubility in toluene and chlorobenzene for **P-2**, while preserving the TADF unit's properties. Subsequently, the resulting polymers were characterized by gel permeation chromatography and their optical properties were studied in both solution and film states.

### References

- [1] *Mater. Chem. Front.* **2023**, 7, 6141
- [2] *Angew. Chem. Int. Ed.* **2019**, 59, 1320
- [3] *Macromolecules* **2023**, 56, 876

# NANOSTRUCTURED POLYMERIC MATERIALS BY SELF-ASSEMBLY: FABRICATION TECHNIQUES AND APPLICATION

*Morozova S.M.*<sup>1,2</sup>, *Golubkov S.S.*<sup>1</sup>, *Statsenko T. G.*<sup>1</sup>, *Baturina E.P.*<sup>1</sup>, *Don G.M.*<sup>3</sup>, *Lihomanov V.S.*<sup>1</sup>, *Sanginov E.A.*<sup>3</sup>, *Belmesov A.A.*<sup>3</sup>, *Kashin A.M.*<sup>1</sup>, *Levchenko A.V.*<sup>3</sup>

<sup>1</sup>Moscow Institute of Physics and Technology, National Research Institute, Institutsky Lane, d 9, 141700, Dolgoprudny, Russia

<sup>2</sup>N.E. Bauman Moscow State Technical University, 2nd Baumanskaya St. 5/1, 105005, Moscow, Russia

<sup>3</sup>Federal Research Center for Problems of Chemical Physics and Medical Chemistry of the Russian Academy of Sciences, Academician Semenov Ave., 1, 142432, Chernogolovka, Russia

Head of the laboratory, Ph.D.

[sofiionova@yandex.ru](mailto:sofiionova@yandex.ru)

Polymer materials with a distinct nanostructure are widely used as gas separation and ion-conducting membranes, drug delivery systems and cell scaffolds [1]. Self-assembly processes are among the most effective for obtaining nano- and microstructured objects [2]. In this work, two approaches for the fabrication of nanostructured polymer materials were utilized: i) control of self-organization of a copolymer consisting of hydrophilic and hydrophobic blocks and its application for fuel cells and ii) formation of fibrillar structures due to the anisotropic nanoparticles of nanocrystalline cellulose (CNC) and use of the obtained colloids as drug delivery systems and cell scaffolds.

Polymer membranes with an Aquivion type structure were annealed at temperatures of 140-150 °C. It was shown that annealing led to a change in nanoscale hydrophilic channels in the membrane within 2-5 nm, which led to a change in the proton conductivity of the membranes (Fig. 1a). Testing of membrane-based electrode blocks has shown their effectiveness, which was comparable to the commercial Nafion211 membrane.

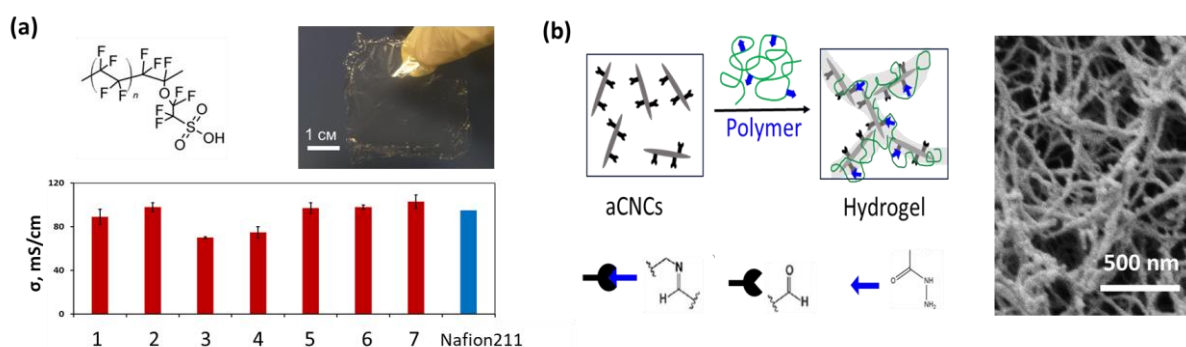

**Figure 1.** (a) Top left: chemical structure of Aquivion copolymer; Top right: photo of annealed membrane; Bottom: proton conductivity of obtained membranes at r.t.. (b) Left: scheme of self-assembly of CNC with polymer to form fibrillar hydrogel; Right: scanning electron microscopy image of obtained hydrogels.

Methods for the production of nanocolloidal hydrogels were developed and implemented due to the reaction of CNC with aldehyde groups with various amino-containing polymers (gelatin [3], chitosan [4], copolymer of polyacrylamide and acrylic acid hydrazide) (Fig. 1b). It was shown that the obtained nanocolloidal gels have a fibrillar structure and possess nonlinear mechanical properties that mimic the mechanics of biological tissues [3].

## References

- [1] *Chemical Society Reviews*, **2023**, 52, 5317.
- [2] *Advanced Materials*, **2024**, 2312707.
- [3] *Proceedings of the National Academy of Sciences*, **2023**, 120, e2220755120.
- [4] *Biomacromolecules*, **2022**, 24, 1173.

## Acknowledgements

This work was supported by Ministry of Science and Higher Education of the Russian Federation (Goszadaniye) 075-03-2024-117, project No FSMG-2022-0012 (experiments on polymer membranes).

# IMPACT OF MODELING CELL SIZES ON THE HYDRODYNAMIC RADIUS OF PAMAM DENDRIMERS G2 IN METHANOL

*Muratova A.D., Komolkin A.V., Markelov D. A.*

Saint-Petersburg State University, Saint-Petersburg, Russia

Student

[st087242@student.spbu.ru](mailto:st087242@student.spbu.ru)

Dendrimers are macromolecules with regular branching, possessing unique properties such as a spherical shape, the ability to encapsulate drug molecules, and a large number of end groups. As shown in references [1-2], the rotational diffusion of carbosilane dendrimers is less sensitive to modeling conditions than translational diffusion. This is particularly true for size of the modeling cell. To accurately obtain the hydrodynamic radius ( $R_h$ ) from translational mobility, the cell size should be at least  $8R_g$  ( $R_g$  being the radius of gyration of the dendrimer). In contrast,  $R_h$  obtained from the rotational mobility of the dendrimer is almost independent of cell size, even at  $4R_g$ . The aim of this study is to verify the conclusions obtained for carbosilane dendrimers for PAMAM dendrimers of different generations ( $G=2-4$ ). [1-2]. Specifically, studying the effect of modeling cell size on translational and rotational diffusion. PAMAM dendrimers in methanol solution were simulated using the GROMACS package with the OPLS force field, employing a full atomistic model of the macromolecule and solvent. To investigate the impact of boundary conditions, modeling cells with linear dimensions ranging from 4 to 12 nm were used. Each system was equilibrated for 1  $\mu$ s. Subsequently, simulations were carried out for 3  $\mu$ s to obtain an equilibrium trajectory. In all simulated systems,  $R_g$  did not depend on the size of the modeling cell and was close to experimental values [3] within the margin of error.

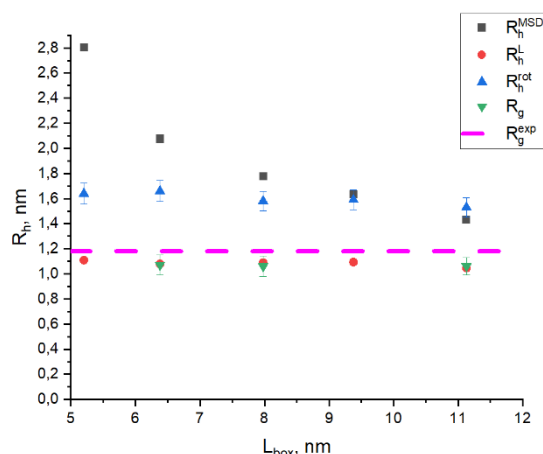

**Figure 1.** The final values of the hydrodynamic radius PAMAM dendrimers G2 for different cells

Figure 1 shows the results after processing the obtained simulation trajectories. For PAMAM dendrimers G2, the hydrodynamic radius obtained from rotational diffusion analysis is independent of the linear size of the simulation cell. It was also found that for the PAMAM dendrimer, the hydrodynamic radius, obtained from translational mobility, decreases with increasing sizes of the simulation cell. Accurate values are achieved when the cell size is greater than 9nm. Correction according [2] to the size of the modeling cell yields low results, smaller than the radius of gyration  $R_g$ .

## References

- [1] Phys. Chem. Chem. Phys. **2023**, 25, 28220-28229
- [2] Book of proceeding "Magnatic Reasonance and its applications. Spinus-2024" St.Petersburg, April 1-5, **2024**
- [3] J Chem Phys. **2004**, 121, 3840-3853

## Acknowledgements

This work is supported by the Russian Science Foundation (grants no. 23-13-00144).

## SOLID PHASE EXTRACTION OF ORGANIC DYES: NEW HORIZONS WITH NICKEL TRIMESINATE

*Naumkina V.N.<sup>1</sup>, Zhinzhilo V.A.<sup>1</sup>, Uflyand I.E.<sup>1</sup>*

<sup>1</sup>Southern Federal University, Rostov-on-Don, Russia

Graduate student

[v.puzhkina@mail.ru](mailto:v.puzhkina@mail.ru)

Dyes are widely used in the production of various products for everyday use - from paper and textiles to food and medicine. This is a growing concern due to the potential contamination of wastewater from dyes due to their persistence and potential carcinogenic and mutagenic effects on the human body. Various methods have been developed to remove dye molecules - physical, biological and chemical. However, such methods usually require complex systems, which come with high operating costs. On the other hand, an alternative, relatively inexpensive and effective method for pollutant removal is adsorption using metal-organic frameworks (MOFs) [1, 2].

The goal of this work was to synthesize MOF based on nickel trimesinate and use it as a sorbent for the analysis of a wide range of dyes. To achieve this goal, the following tasks were formulated: to synthesize MOF, study the adsorption process of various dyes, study the influence of various parameters on the efficiency of dye removal, determine thermodynamic and kinetic parameters, and also determine the sorption process of organic dyes from artificial seawater.

MOF based on nickel trimesinate was obtained by "green" synthesis in an alkaline medium. IR, XRD, and SEM analyzes were carried out, the results of which are consistent with the data obtained previously. First, the dependence of solid-phase extraction of the dye on the weight of the sorbent, initial concentration, contact time and pH of the medium in distilled water was studied. Equilibrium adsorption data were analyzed using two adsorption models: Langmuir and Freundlich. The results of determining the coefficients show that the adsorption process most accurately corresponds to the conditions of Langmuir isotherms. The values of thermodynamic parameters ( $\Delta G^0$ ,  $\Delta H^0$ ,  $\Delta S^0$ ) obtained during the experiment indicate a spontaneous and weakly exothermic process. Low Gibbs energy values indicate the presence of physical adsorption. By studying the kinetic parameters, it was found that the pseudo-first order equation satisfactorily describes the patterns of adsorption at the initial stages of the adsorption process, when the phenomenon of film diffusion has a significant effect on the process. It can be assumed that an increase in the concentration of sorbate molecules on the surface of the adsorbent at the initial moments of the process at low degrees of filling of the adsorption space stimulates the movement of sorbate molecules inside the pores of the adsorbent under the influence of a concentration gradient, but subsequently this process slows down, which, in turn, potentiates other mechanisms.

Currently, the marine environment is becoming more and more polluted due to the release of dangerous dyes into it. Therefore, we studied the adsorption characteristics of the sorbent in artificial seawater. The Lyman and Fleming formula was used to prepare an artificial seawater solution by dissolving analytical-grade reagents in bi-distilled water. Salinity was 34.481%; pH was adjusted to 7.5, 8, 8.2, and 8.5 with sodium hydroxide (NaOH) or hydrochloric acid (HCl). At this stage of the study, serial experiments were carried out on the adsorption of dyes chlorophenol red, methyl green, and eosin B in artificial seawater. Adsorption studies were carried out depending on the same parameters as in distilled water, observing similar dependencies. The presence of various inorganic salts in artificial seawater has less effect on the adsorption of low concentration dye solution compared to high concentration dye solution. The decrease in the adsorption capacity of the sorbent in artificial seawater compared to an ideal aqueous solution is only 3–6%.

The sorbent is effective for the extraction of cationic organic dyes at low temperatures. The maximum adsorption that the sorbent can achieve in distilled water is 224 mg/g, which is a fairly high indicator. The maximum adsorption that the sorbent allows to achieve in artificial seawater is 136.4 mg/g, which is much lower than in distilled water. The decrease in adsorption capacity is associated with a deterioration in the solubility of dyes after the addition of various inorganic sites to the solution and the competition of  $\text{SO}_4^{2-}$ ,  $\text{Cl}^-$ ,  $\text{F}^-$ , etc. ions with dye molecules for unsaturated areas on adsorbents.

### References

- [1] *Microchem. J.*, **2021**, 168, 106387.
- [2] *Appl. Chem.*, **2021**, 94, 1453.

### Acknowledgements

This work was supported by the Russian Science Foundation (project No 22-13-00260).



# SYNTHESIS OF DIMERS, TRIMERS, TETRAMERS AND PENTAMERS OF 5-*N*-BUTYLNORBORNENE BY ROMP IN THE PRESENCE OF THE 1<sup>ST</sup> AND 2<sup>ND</sup> GENERATION GRUBBS CATALYST. HYDROGENATION OF METATHESIS POLYMERIZATION PRODUCTS

*Nazemutdinova V.R.*<sup>1,2</sup>, *Sadovnikov K.S.*<sup>1</sup>, *Wozniak A.I.*<sup>1</sup>, *Morontsev A.A.*<sup>1</sup>, *Zhigarev V.A.*<sup>1</sup>, *Bermeshev M.V.*<sup>1</sup>

<sup>1</sup>A.V. Topchiev Institute of Petrochemical Synthesis RAS, Moscow, Russia

<sup>2</sup>MIREA - Russian Technological University, Moscow, Russia

Student

[nazemutdinova@ips.ac.ru](mailto:nazemutdinova@ips.ac.ru)

One of the obstacles in the development of the Arctic and the Far North is low ambient temperatures, which limit the use of machinery and equipment in this region. Low temperatures lead to solidification of technical fluids, including motor oil. Therefore, one of the factors for the successful development of these regions is the creation of motor oils with moderate viscosity at low temperatures, allowing for safe "cold start" of an engine. As a rule, such oils are created based on branched poly( $\alpha$ -olefins) with long side hydrocarbon substituents [1]. We assume that it is the large number of the main chain branches and the presence of long side substituents that are the key factors that determine low freezing points of oils. Therefore, we decided to obtain similar branched compounds with side hydrocarbon substituents based on hydrogenated dimers, trimers, tetramers and pentamers of 5-*n*-butylnorbornene (ButNB), which could potentially be used as low-temperature synthetic motor oils. The purpose of this work is to develop a method for producing hydrogenated metathesis oligomers of ButNB based on the tandem synthesis of ButNB oligomers by ring opening metathesis polymerization (ROMP) - hydrogenation of the metathesis products without isolating unsaturated polymers at an intermediate stage. The synthesis of ButNB oligomers was carried out by ROMP of the corresponding alkyl-substituted norbornene in the presence of a first- or second-generation Grubbs catalyst and 1-hexene, acted as a chain transfer agent (Scheme 1). To regulate the molecular weights of the resulting oligomers, the poly(ButNB) synthesis was carried out in the presence of 1-hexene and 6-brom-1-hexene. Hydrogenation was conducted under different catalyst concentrations, temperatures, and pressures.

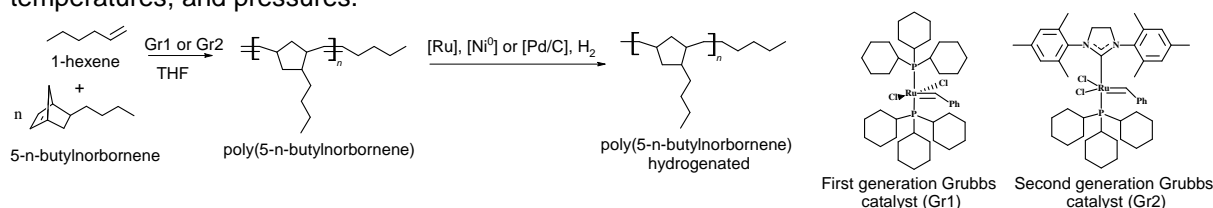

**Scheme 1.** Tandem synthesis of 5-*n*-butylnorbornene oligomers by ring opening metathesis polymerization - hydrogenation of the resulting products

Subsequent hydrogenation was performed using three types of catalysts. In the case of using ruthenium compounds that catalyzed the metathesis reaction at the previous step of the synthesis, the inert atmosphere was changed by hydrogen atmosphere and the reaction temperature was increased. Metallic nickel was also applied as a catalyst and was prepared directly in the reaction mass in the presence of hydrogen atmosphere. In this case, hydrogenation was carried out under elevated pressures and temperatures. In the case of using Pd/C, the hydrogenation was carried out under hydrogen atmosphere at room temperature.

The ratio of metathesis and hydrogenated dimers, trimers, tetramers and pentamers of ButNB was assessed using preparative gel permeation chromatography (GPC) and MALDI-TOF. The resulting components were separated by preparative GPC, their structure was confirmed by <sup>1</sup>H, <sup>13</sup>C, <sup>13</sup>C (DEPT-135) NMR spectroscopy, including <sup>1</sup>H-<sup>1</sup>H COSY, <sup>1</sup>H-<sup>13</sup>C HSQC-DEPT 135, <sup>1</sup>H-<sup>13</sup>C HMBC correlation spectroscopy. Based on the signals of the terminal double bond protons on the <sup>1</sup>H NMR spectrum was calculated the polymerization average degree of ButNB oligomers, which coincided with the GPC data. The conversion of double bonds was assessed by the disappearance of proton signals in the olefinic region in the <sup>1</sup>H NMR spectrum. The thermal properties of ButNB oligomers were studied by DSC and TGA analysis.

## References

[1] *Appl. Catal. A Gen.* **2018**, 549, 40.

## Acknowledgements

This work was supported by the Russian Science Foundation (project No 23-73-00126).

## SYNTHESIS AND PHASE BEHAVIOR OF NOVEL TEMPERATURE-RESPONSIVE COPOLYMERS OF N-VINYL-2-PYRROLIDONE

*Nechaeva A.M.<sup>1</sup>, Saratovceva E.E.<sup>1</sup>, Pantileeva S.V.<sup>1</sup>, Mezhuev Y.O.<sup>1</sup>*

<sup>1</sup> Dmitry Mendeleev University of Chemical Technology of Russia, Department of Biomaterials, Moscow, Russia  
Senior lecturer  
[nechaeva.a.m@muctr.ru](mailto:nechaeva.a.m@muctr.ru)

The use of synthetic polymers in delivery systems not only enables the enhancement of drug bioavailability and circulation time in the bloodstream, but also the regulation of drug release profiles [1]. This latter objective can be achieved by using a specific class of "smart" polymer materials that are capable of responding to external stimuli. This class includes temperature-responsive or thermoresponsive polymers, which are macromolecules that react in response to temperature changes. Due to their distinctive properties, thermoresponsive polymers are of interest for the development of drug and gene delivery systems, as well as tissue engineering [2].

A series of thermoresponsive amphiphilic copolymers of N-vinyl-2-pyrrolidone (NVP) with glycidyl methacrylate (GMA) and acrylic acid (AA) were synthesized through radical copolymerization in solution in the presence of hydrophobic chain transfer agents (CTA). The structure of these copolymers was confirmed by <sup>13</sup>C and <sup>1</sup>H NMR and the processes of their aggregation in aqueous solution with temperature changes were studied through dynamic light scattering (DLS).

The macromolecules of the synthesized copolymers were observed to undergo reversible aggregation in aqueous solution when the critical temperature was exceeded (scheme 1). It was demonstrated that the critical temperature, as well as the size of the aggregates, depended both on the monomeric composition of the copolymers and on their molecular weight. The lower critical solution temperature (LCST) of all synthesized copolymers was found to lie within the temperature range of 26-35 °C, which is close to the physiological temperature.

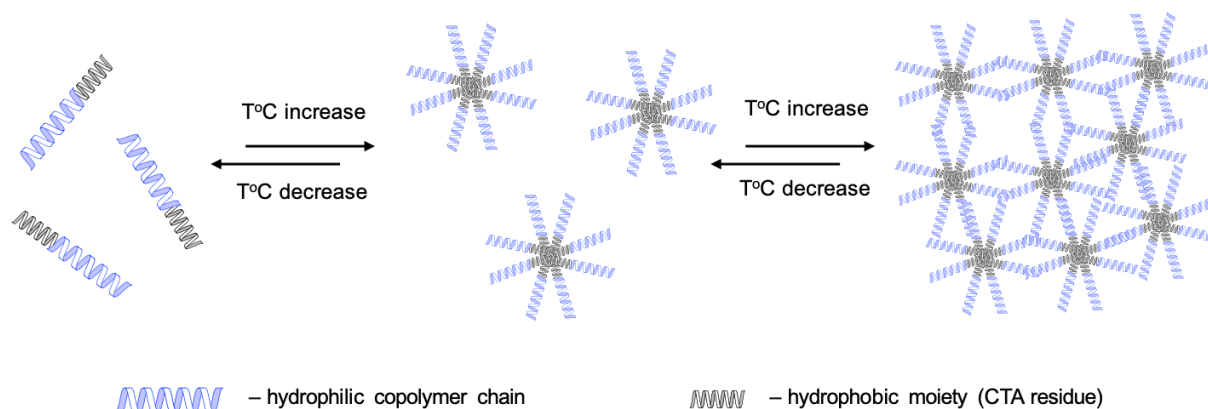

**Scheme 1.** The reversible aggregation of macromolecules in response to temperature changes

Consequently, the synthesized thermosensitive copolymers of N-vinyl-2-pyrrolidone are of interest for the development of biomedical materials, including drug delivery systems.

### References

- [1] *Progress in Polymer Science.* **2018**, 87, 107-164
- [2] *Polymers.* **2011**, 3, 1215-1242

## SOFT POLY( $\epsilon$ -CAPROLACTONE)-BASED CORE-SHELL NANOPARTICLES

*Orlov M.S.<sup>1</sup>, Baeva A.S.<sup>1</sup>, Sinitsyna E.S.<sup>1</sup>, Korzhikov-Vlakh V.A.<sup>1</sup>*

<sup>1</sup> St. Petersburg State University, St. Petersburg, Russia  
Student

[st084341@student.spbu.ru](mailto:st084341@student.spbu.ru)

The development of new therapeutic approaches against tuberculosis represents the important task of modern medicinal chemistry. Both, development of more effective drug molecules and drug delivery systems are on demand to win the battle with this widespread disease [1]. Regarding advances in drug delivery systems, the development of formulations capable for encapsulation and controlled release of two or three antimycobacterial agents is on demand. Core-shell nanoparticles (NPs) possessing a hydrophobic core and a hydrophilic hydrogel-like shell represents a perspective variant of nanoformulations for local treatment of lung tuberculosis with application of nebulizer. Such NPs may allow co-encapsulation of different molecules both into the core and shell. The shell can also be modified with peptide ligands necessary for targeting or mucoadhesion. It was recently shown, that such shell could affect the drug release from the core of particles [2]. We also propose that the thickness of such shell could help to regulate particles stiffness, which is currently believed to be an important factor affecting biointeractions of particles with biological surrounding [3].

In present study we have obtained poly( $\epsilon$ -caprolactone) NPs (PCL NPs) and form the shell on their surface with application of biocompatible polyelectrolytes – chitosan (Chit) and hyaluronic acid (HA). Positively charged Chit was first covalently attached to the surface of NPs and then oppositely charged HA was attached (Figure 1). Further layer-by-layer addition of polyelectrolytes allowed us to control the thickness of the shell and particles stiffness.

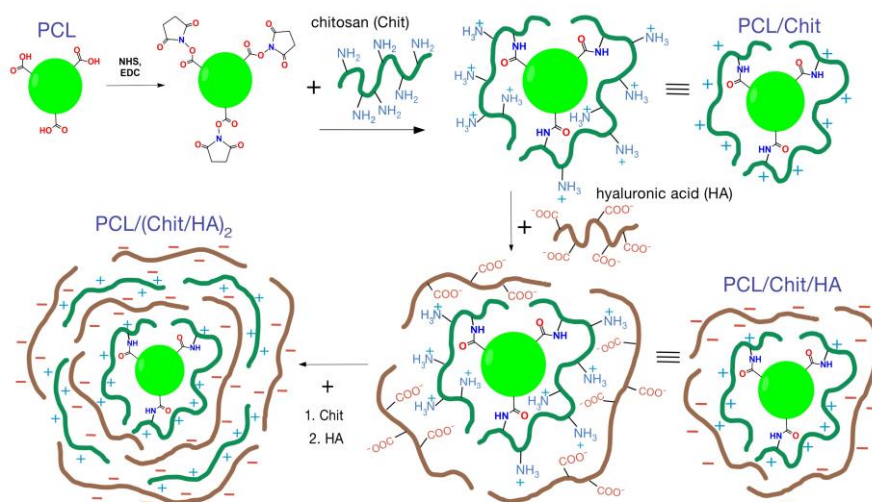

**Figure 1.** The strategy for shell formation on the surface of PCL NPs.

We have tested the effect of particles charge on their biocompatibility. It was shown that addition of hyaluronic acid reduces the toxicity of particles for the cells. Moreover, first experiments on drugs co-encapsulation showed that obtained nanoformulations are able to entrap both hydrophilic and hydrophobic drug molecules.

### References

- [1] *Front. Pharmacol.* **2021**, *12*, 749945
- [2] *Pharmaceutics.* **2021**, *13*(6), 801
- [3] *Nanoscale.* **2017**, *9*, 454

### Acknowledgements

This work was supported by the Russian Science Foundation (project No 24-15-00185).

## NEW CHAIN EXTENDER FOR SELF-HEALING POLYURETHANE

*Ponomareva P.F.*<sup>1,2</sup>, *Platonova E.O.*<sup>1,2</sup>, *Solodilov V.I.*<sup>1,2</sup>

<sup>1</sup>N.N. Semenov Federal Research Center for Chemical Physics, Russian Academy of Sciences, Moscow, Russia

<sup>2</sup>Bauman Moscow State Technical University Moscow, Russia

PhD student

[ponomareva.p.f@gmail.com](mailto:ponomareva.p.f@gmail.com)

The Diels-Alder reaction (DA) is a thermally reversible cycloaddition [4+2] involving diene and dienophile, which is often used to create stimulus-sensitive and self-healing materials. The introduction of DA-adducts into the polymer structure gives them the ability to heal damage repeatedly. It is quite easy to start the healing process by heating the damaged area or the entire sample.

This paper presents a synthetic method for producing new chain extenders from glycidyl esters and amines with different contents of furan groups (mono-, di- and tri-furan diols), with which polyurethane (PU) can be given the ability to self-heal. The yields of the reactions amounted to more than 91%. Furan-terminated prepolymers were obtained from synthesized diols. Polyurethanes with different ratios [Fu group]:[mal group] were obtained via Diels-Alder reaction between a furan-containing chain extension and bismaleimide (Scheme 1). The synthesized polyurethanes were yellow transparent films. However, mono-furandiols based polymers turned out to be unsuitable for mechanical testing (brittle and sticky). The properties of PU were studied and the effect of the concentration of furan groups on self-healing ability and mechanical properties was evaluated.

The ability of the polyurethane to be repeatedly processed without loss of mechanical properties is shown. It was found that the strength and effectiveness of self-healing of the resulting PU increases with a higher BMI content. Polyurethanes based on difuranediols have the best self-healing ability, but the greatest strength is observed in tri-furan diol samples.

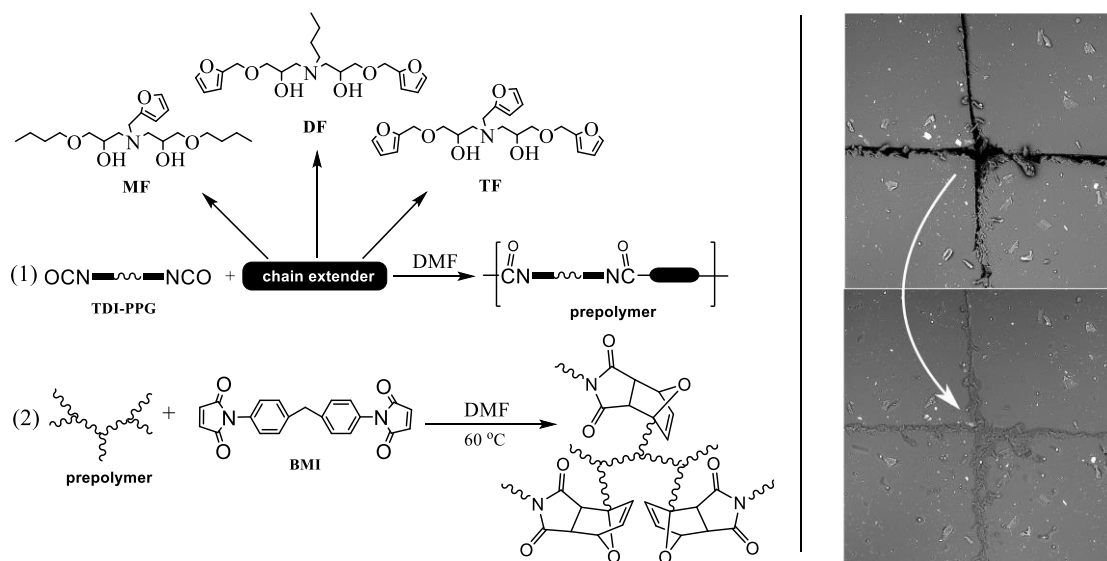

**Scheme 1.** Scheme of synthesis of self-healing polyurethanes and micrographs of the surface before and after self-healing

### Acknowledgements

This work was supported by the Russian Science Foundation (project No 24-29-00848).

## EFFECT OF ZINC OXIDE NANOPARTICLES ON THE PROPERTIES OF PLA-FILMS

*Pozdniakova A.V.<sup>1</sup>, Sukhanova A.A.<sup>1</sup>*

<sup>1</sup> Reshetnev Siberian State University of Science and Technology, Scientific Laboratory of Macromolecular Compounds, Krasnoyarsk, Russia

Junior researcher

[PozdniakovaAV@yandex.ru](mailto:PozdniakovaAV@yandex.ru)

Today, the packaging materials industry is a constantly developing area. The ecological situation and changing consumer demands lead research to the development of more and more innovative materials for functional packaging (smart packaging) and low environmental impact (biodegradable materials, recyclable packaging with reduced size). Poly(lactic acid) (PLA) is one of the most promising materials by all of the renewable source-based biodegradable polymers by reason of it is thermoplastic, biodegradable, and biocompatible with superior mechanical properties, good processability, and low cost. Since PLA is a highly transparent and rigid plastics with high mechanical properties, it has been used for the fabrication of various products such as trays, cups, tubs, and films [1,2]. However, PLA has some limitations for food packaging applications due to its low gas and water vapor barrier properties, weak thermal stability, high rigidity, and low toughness and ductility [3]. To overcome existing shortcomings and produce films with additional functional properties, PLA is mixed with nanofillers such as nanoclay, nanocellulose and nanometals. Among the metallic or metal oxide nanofillers, zinc oxide nanoparticles (ZnO NPs) are interesting since they possess a large surface area and several unusual properties such as availability, stability, high ultraviolet absorption capacity, and strong antimicrobial activity [4,5]. Accordingly, ZnO NPs have been considered as a potential candidate for improvement materials of the polymer matrix in the food packaging applications. Zinc oxide nanoparticles were obtained by direct precipitation using aqueous solutions of  $ZnSO_4 \cdot 7H_2O$  and KOH and subsequent calcination of the precipitate at a temperature of 500°C in an air atmosphere for 3 hours. The resulting particles in a form of nanosheets were up to 100 nm. We obtained PLA/ZnONPs composite films using a solution casting method and characterized their properties using various analytical methods. According to SEM the surface structure of PLA films was smooth, while PLA/ZnO NPs films showed a higher population of white rough spots. The roughness of the film increased with increase in the concentration of ZnO NPs. The PLA film was highly transparent against both UV and visible light as observed high transmittance of light between 250 and 700 nm. However, the transmittance of light decreased significantly after incorporation of ZnO NPs. The decrease in transmittance of the PLA films was dependent on the content of ZnO NPs. The PLA/ZnO NPs composite films with UV screening capacity, especially for UV-B (280–320 nm) and UV-A (320–400 nm), can be properly used for the application of UV-light prevention food packaging to prevent photocatalytic reactions in the packaged foods.

### References

- [1] *J. Appl. Polym. Sci.* **2013**, 127, 2290
- [2] *J. Food Sci.* **2014**, 79, 1447
- [3] *J. Appl. Polym. Sci.* **2007**, 106, 1813
- [4] *Food Hydrocoll.* **2015**, 5, 264
- [5] *Mater Sci Eng C Mater Biol Appl.* **2018**, 93, 289

### Acknowledgements

This research was carried out within the state assignment of the Ministry of Science and Higher Education of the Russian Federation for the implementation of the project “Pattern Research of chemical-biotechnological synthesis of biodegradable polymers” (project No FEFE-2024-2027).

## DEVELOPMENT AND INVESTIGATION OF NOVEL POROUS MEMBRANES BASED ON CELLULOSE ACETATE MODIFIED BY POLYMERS AND CARBON NANOPARTICLES

*Puzikova M.E.<sup>1</sup>, Kuzminova A.I.<sup>1</sup>, Dmitrenko M.E.<sup>1</sup>, Dubovenko R.R.<sup>1</sup>, Penkova A.V.<sup>1</sup>*

<sup>1</sup> St. Petersburg State University, St. Petersburg, Russia

Student

[st095099@student.spbu.ru](mailto:st095099@student.spbu.ru)

To date, it is difficult to imagine such an area of industry where there would be no need for separation of liquid mixtures. One of the most promising separation methods is membrane filtration, in particular, ultrafiltration. In this work, cellulose acetate was used as a polymer matrix, since it has a number of advantages such as biodegradability, hydrophilicity, and high resistance to surface contamination. At the same time, cellulose acetate membranes have low resistance to aggressive media and chemical influences, as well as extremely low mechanical strength. Improving these properties is an urgent task of membrane technology. One of the ways to improve the properties of porous membranes is their modification with additives and/or nanoparticles. In this study, to improve CA membrane performance, polysulfone (PS), Pluronic F127 (PL), polyethylene glycol (PEG), and a combination of PS-PL were chosen as additives. Also we chose such modifiers as carbon nanoparticles (single-wall carbon nanotubes (SWCNTs), multi-walled carbon nanotubes (MWCNTs), graphene oxide (GO), and fullerene C<sub>60</sub>). Their introduction into polymer matrices leads to significant changes in the morphology and mechanical and physicochemical properties of membranes due to their functional groups and structure, as a result of which the membrane performance and resistance to fouling are improved.

Thus, the aim of this work was to study the effect of various preparation conditions, additives, modifiers, and combinations of them, on structural, physicochemical, and transport properties of a porous ultrafiltration CA-based membrane, and the development of ultrafiltration CA-based membranes with improved performance for water treatment. The structural and physicochemical properties of the developed CA-based membranes were studied by scanning electron microscopy (SEM), atomic force microscopy (AFM), Fourier-transform infrared spectroscopy (FTIR), X-ray photoelectron spectroscopy (XPS), and contact angle measurements. The transport properties of the developed CA-based membranes were evaluated in ultrafiltration of bovine serum albumin (BSA). Membranes with optimal properties were tested in the ultrafiltration of dextran 110 and polyvinylpyrrolidone (PVP) K-90.

### **Acknowledgements**

This work was supported by the Russian Science Foundation (grant № 20-79-10064, <https://rscf.ru/project/20-79-10064/>). The experimental work of this study was facilitated by the equipment from the Chemical Analysis and Materials Research Centre, Centre for X-ray Diffraction Methods, Magnetic Resonance Research Centre, Centre for Innovative Technologies of Composite Nanomaterials, Nanophotonics Centre, Cryogenic department, Computing Centre, Centre for Physical of Surface Investigation, Centre for Diagnostics of Functional Materials for Medicine, Pharmacology and Nanoelectronics, Thermogravimetric and Calorimetric Research Centre and the Interdisciplinary Resource Centre for Nanotechnology at the St. Petersburg State University.

# COMBINED RECYCLING AND UPCYCLING OF POLY(BISPHENOL A CARBONATE) THROUGH METAL ACETATE CATALYZED GLYCOLYSIS

*Pyatakov D.A.<sup>1</sup>, Ivchenko P.V.<sup>1,2</sup>, Tavtorkin A.N.<sup>1</sup>, Nifant'ev I.E.<sup>1,2</sup>*

<sup>1</sup> Topchiev Institute of Petrochemical Synthesis RAS, Moscow, Russia

<sup>2</sup> Moscow State University, Moscow, Russia

Researcher, Ph.D. in Chemistry

[dinamity06@gmail.com](mailto:dinamity06@gmail.com)

Chemical processing into initial monomers (recycling) or into value-added products (upcycling) are the most promising areas of plastic waste disposal [1]. The nature of the polymer critically affects the efficiency of processing methods, therefore, polyesters – polyethylene terephthalate PET and poly(bisphenol A carbonate) BPAC are convenient objects for the application of catalytic approaches [2]. Catalytic glycolysis of BPAC looks very promising, consisting in chemical processing into bisphenol A (BPA) and cyclic carbonates (the so-called ‘extraction of carbonyl’) [3]. A cheap, effective and selective catalyst for such a process has not yet been found.

In this work, we compared the catalytic properties of metal acetates (M = Li, Na, K, Mg, Ca, Zn) in glycolysis of BPAC and demonstrated high yields of BPA and ethylene carbonate using Mg(OAc)<sub>2</sub> or Zn(OAc)<sub>2</sub> as catalysts (model reaction with ethylene glycol). The scope and limitations of these catalysts in the use of various 1,2-, 1,3- and 1,4-diols, as well as the proposed mechanism of such glycolysis, are also presented and discussed (Fig. 1). DFT modeling of metal complexes with components of the reaction mixture made it possible to explain the low catalytic activity of Li, Na, K and Ca acetates, in comparison with Mg and Zn acetates.

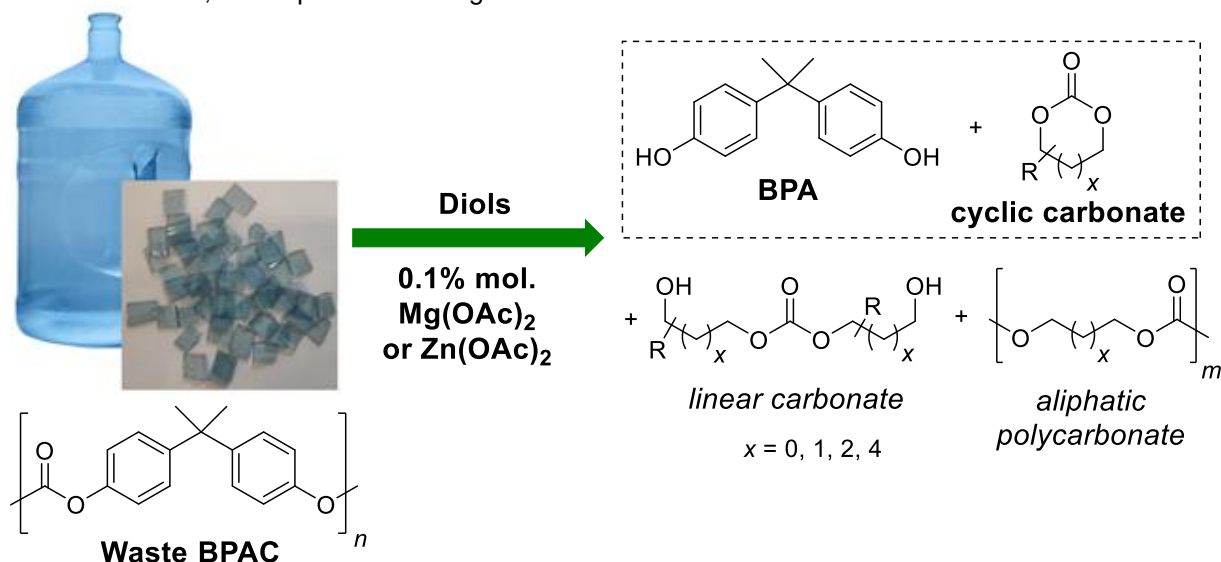

**Figure 1.** M(OAc)<sub>2</sub>-catalyzed glycolysis of BPAC (M = Mg, Zn).

The use of simple and low-cost complexes of nontoxic metals was evidenced to be a promising and efficient strategy for chemical recycling of waste polyesters. The further development of this strategy could will be based on simple and synthetically available complexes of nontoxic metals, currently used in the synthesis of biocompatible and biodegradable polyesters. The catalyst design can be assisted by quantum-chemical modeling, by comparison of the relative stability of metal phenolates and  $\kappa^2$ -HOCH<sub>2</sub>CH<sub>2</sub>O<sup>-</sup> complexes for selected ligand environment. One of the goals of similar design is the development of fully recyclable catalysts as an alternative to highly efficient and low cost homogeneous catalysts presented in this work.

## References

- [1] *Nat. Rev. Mater.* **2020**, 5, 501
- [2] *Mater. Horiz.* **2021**, 8, 1084–1129
- [3] *ChemSusChem* **2021**, 14, 4041

## Acknowledgements

This work was supported by the Russian Science Foundation (project No. 21-73-30010).

## DYNAMIC SURFACE PROPERTIES OF $\beta$ -CASEIN FIBRILS ADSORPTION LAYERS

*Rafikova A.R.<sup>1</sup>, Milyaeva O.Yu.<sup>1</sup>, Noskov B.A.<sup>1</sup>*

<sup>1</sup> St. Petersburg State University, St. Petersburg, Russia

Graduate student

[nastya.rafikova.2000@mail.ru](mailto:nastya.rafikova.2000@mail.ru)

Many food proteins can be easily converted into fibrillar aggregates [1], which have been shown in recent years to be highly effective in stabilizing foams and emulsions [2]. Such stabilizing activity is mainly due to the dynamic surface properties of the fibril interfacial layers formed by the fibrils [3]. In this work adsorption films of  $\beta$ -casein fibrils at the air-water interface were studied.

$\beta$ -Casein fibrils were prepared at pH 2 and the temperature of 90°C. The kinetics of fibril formation was studied using thioflavin T fluorescence analysis. The dynamic surface tension was measured by the Wilhelmy plate method. The dynamic surface elasticity was determined by the oscillating barrier method. Atomic force microscopy (AFM) was used to determine the micromorphology of the adsorption layers. Dispersions of fibrils were purified by centrifugation, replacing the supernatant with triply distilled water and redispersion.

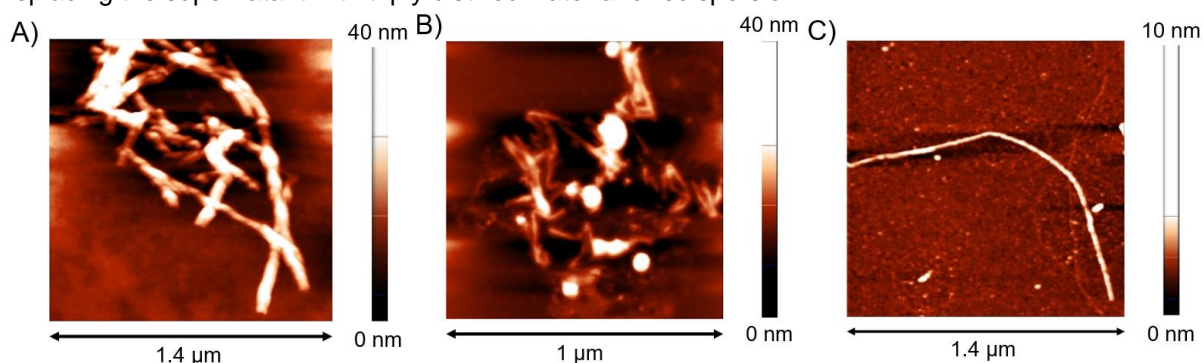

**Figure 1.** AFM images of A)  $\beta$ -casein fibrils after preparation, B, C) adsorption layer of two-time purified fibrils dispersion.

The aggregate dispersions may contain a large number of unreacted peptides. Their adsorption at the initial stage makes a significant contribution to the dynamic surface properties even after one-time purification of the dispersion. In this case, at the low surface age the dynamic surface elasticity dependencies has a local maximum, which was previously obtained for adsorption layers of native  $\beta$ -casein [4]. The fibril contribution to dynamic surface properties appears at high surface ages. For more purified dispersions, where the relative concentration of fibrils is higher, their effects increase. It was found that the dynamic surface elasticity of two-time purified dispersion of  $\beta$ -casein fibrils near the equilibrium reaches about 48 mN/m, and is four times higher than the results for the native protein solution. This behavior significantly differs from that of fibrillar aggregates of globular proteins, where the increase in the surface elasticity exceeds the values for native proteins only by 10 – 40% [5]. The presence of  $\beta$ -casein fibrils in the adsorption layer was confirmed by AFM images (Fig. 1B, C).

### References

- [1] *Adv. Colloid Interface.* **2019**, 269, 334
- [2] *Food Chem.* **2021**, 354, 129554
- [3] *Langmuir.* **2014**, 30, 10090
- [4] *J. Phys. Chem. C.* **2007**, 111, 16895
- [5] *Colloids Surfaces B Biointerfaces.* **2022**, 220, 112942

### Acknowledgements

This work was supported by the Russian Science Foundation (project No 23-73-10021).



## DEVELOPMENT OF NOVEL MEMBRANES BASED ON POLYETHER BLOCK AMIDE MODIFIED BY METAL-ORGANIC FRAMEWORK MIL-125

*Rakovskaya N.S.<sup>1</sup>, Kuzminova A.I.<sup>1</sup>, Dmitrenko M.E.<sup>1</sup>, Dubovenko R.R.<sup>1</sup>,  
Penkova A.V.<sup>1</sup>*

<sup>1</sup> St. Petersburg State University, St. Petersburg, Russia  
Student  
[st094879@student.spbu.ru](mailto:st094879@student.spbu.ru)

In modern water treatment processes, membrane technologies occupy a leading position, ensuring high efficiency, environmental safety and rational use of resources. Among the promising membrane processes, pervaporation stands out, which has proven itself to be an effective method of purification and separation of liquid substances. This technology belongs to sustainable processes, which is due to a number of advantages over traditional separation methods: high energy efficiency, flexibility, mild operating conditions, ease of automation and environmental friendliness [1].

Improving water treatment methods using membrane technologies requires the development of new materials and the creation of highly efficient membranes. One of the key directions in this field is the modification of membranes aimed at improving their transport properties. Polyether block amide (PEBA) is considered as a promising material for creating membranes, the structural feature of which – the possibility of varying the ratio of blocks – allows to obtain polymers, and therefore polymer membranes with specified characteristics [2].

In this work, PEBA membranes modified with a metal–organic framework (MOF) MIL-125 have been developed. MIL-125 is a titanium–based MOF with high porosity, chemical and thermal stability. Methods of nuclear magnetic resonance, Fourier transform infrared spectroscopy, scanning electron microscopy, atomic force microscopy, thermogravimetric analysis were used to study the physicochemical properties of modified membranes, as well as experiments on swelling and measuring the angle of contact with water. The transport properties of the membranes were studied during the initial separation of the isopropyl alcohol/water mixture (5/95 wt. %). The composition of the initial mixture and permeate was analyzed by gas chromatography. The results showed that modification of the PEBA membranes using MIL-125 leads to an improvement in their transport characteristics.

### References

- [1] *Separation and Purification Technology* **2021**, 263, 118370  
[2] *Polymers* **2023**, 15, 3834

### Acknowledgements

The authors acknowledge Saint-Petersburg State University for a research project 11602266. The experimental part was carried out with the participation of resource centers: Interdisciplinary Resource Center in the field of Nanotechnology, Thermogravimetric and Calorimetric research methods, Cryogenic Department, Geomodel, Magnetic resonance research methods, Innovative technologies of composite nanomaterials, X-ray diffraction research methods, Methods of substance composition analysis, St. Petersburg State University Computing Center, Physical Methods of surface research, Nanoconstruction of photoactive materials St. Petersburg State University.

# THE PREPARATION OF A PAINT COATING BASED ON AN ACRYLIC COPOLYMER AND A BLOCKED ISOCYANATE UTILISING THE CATHODIC ELECTRODEPOSITION METHOD

*Rodnikov D.T.*<sup>1</sup>, *Ahkar Kaung Myint.*<sup>1</sup>, *Malyavina Y.M.*<sup>1</sup>, *Ozdoev A.A.*<sup>1</sup>, *Silaeva A.A.*<sup>1</sup>, *Soldatov M.A.*<sup>1</sup>

<sup>1</sup>Mendeleev University of Chemical Technology of Russia, Moscow, Russia

Graduate student

[sovsemnexamik@gmail.com](mailto:sovsemnexamik@gmail.com)

Cathodic electrodeposition is an advanced method of applying paints to conductive substrates. Due to its environmental friendliness, the ability to paint objects of any configuration and other advantages, this method is widely used. The greatest application is in the field of car painting [1].

Polyacrylates derived from various derivatives of acrylic and methacrylic acids can be used as a polymer base. The use of different hydroxyl-containing monomers enables the production of weather-resistant coatings using isocyanate hardeners. In order to utilize such compounds in aqueous environments, pre-blocking is carried out [2].

In this study, a copolymer of butyl methacrylate and glycidyl methacrylate was synthesised, from which an epoxy amine adduct was prepared. Copolymers with varying ratios of the initial monomers were synthesised, and the optimal ratios were identified. The coatings obtained following curing with isocyanates exhibited enhanced elastic properties and improved weather resistance.

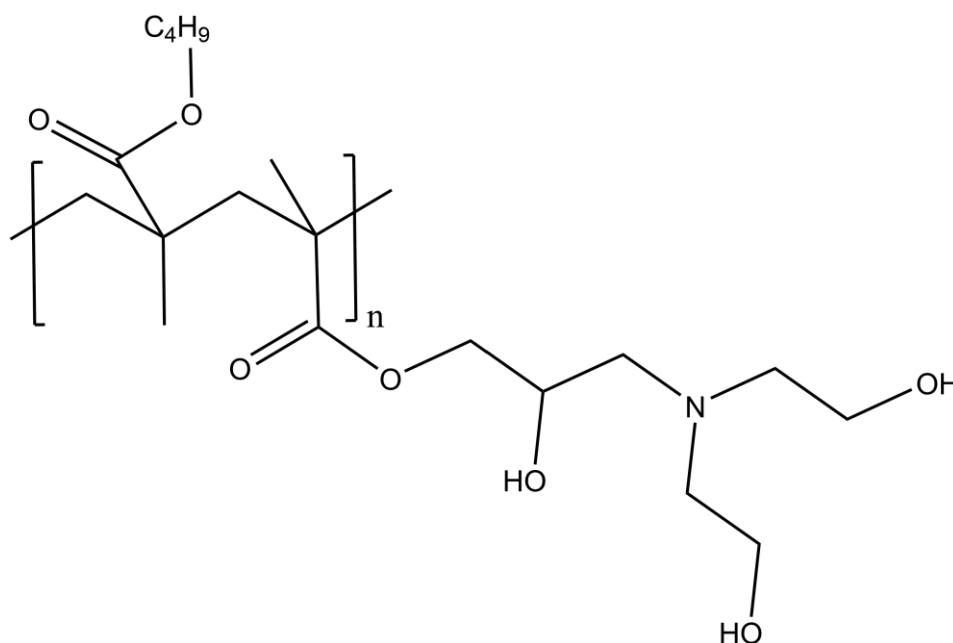

**Scheme 1.** Copolymer structure

## References

- [1] Krilova I.A., Kvasnikov M.U., Okraska metodom electroosajdeniia na rubeje vekov. Obzor literature. Chast' I. [Electrodeposition painting at the turn of the century. Literature review. Part I]. *Lakokrasochnie materialy i ih primenenie*, 2001, no. 4, pp. 10-15.
- [2] Sichova M.V., Garipov R.M., Derebrdiev R. Y. Modificatsiya epokcidnih materialov izotsianatami [Modification of epoxy materials with isocyanates]. *Vestnik Kasanskogo tehnologicheskogo universiteta*, 2009, no.6, pp. 193-198.

# IMPACT OF PH AND IONIC STRENGTH ON SILK FIBROIN SELF-ASSEMBLY AT AIR-WATER INTERFACE

*Rotanova K.Yu.<sup>1</sup>, Milyaeva O. Yu.<sup>1</sup>*

<sup>1</sup> St. Petersburg State University, St. Petersburg, Russia  
Student

[rotanova.ksyusha@gmail.com](mailto:rotanova.ksyusha@gmail.com)

Studies of protein-based materials intended for use as biomaterials in medical applications have attracted great attention. Bombyx mori silk fibroin (SF) is one of the most common proteins used for that purposes [1]. The ability to self-assembly on air–water interface opens new perspective for obtaining materials with the controlled morphology. Besides of self-assembly it provides unique mechanical properties and high biocompatibility [2,3]. Morphology and its relationship with the mechanical properties of SF adsorption layers, as well as understanding the mechanism of SF adsorption at the water/air interface, can play an important role in the design of biomaterials. The pH and ionic strength can regulate the processes of SF self-assembly and regulate the type of obtained film. The complex approach based on dynamic surface rheology, ellipsometry and various types of microscopy was applied to investigate the formation of SF films on air-water interface at different conditions.

The change in the dynamic surface elasticity reflects the changes in surface layer structure. The increase of surface age and protein concentration results in high values of surface elasticity connected with a gradual formation of different types of morphology. It starts from formation of a connected two-dimensional network and finishes when it transforms to the uniform film with the thickness of about 40 nm. The highest values of 220 mN/m correspond to 0.005 – 0.02 mg/ml when one can observe the coexistence of two-dimensional network with a wide ribbons organized in a tree-like structure.

The increase of ionic strength does not lead to significant changes of the dynamic surface elasticity. The obtained results are almost independent of the NaCl concentration in the range 0 - 0.1 M. It can be assumed that the electrostatic barrier is negligible even without salt at SF concentrations higher than 0.02 mg/ml due to a relatively high protein concentration and the adsorption layer formation is diffusion controlled.

pH change leads to the much more noticeable effects. The intermolecular interactions between silk fibroin molecules in the surface layer are sensitive to pH and consequently affects network formation and dynamic surface elasticity. At pH=4 near the isoelectric point, a decrease in electrostatic repulsion results in rapid formation of self-organized structures in the surface layer, providing high values of dynamic surface elasticity. With pH increase, the rate of change of the surface properties changes slightly, but the values of dynamic surface elasticity decrease by approximately 25%. After reaching a pH close to neutral, the values remain approximately constant and change slightly with a further increase in pH.

## References

- [1] *Int. J. Mol. Sci.* **2022**, 23(22), 14421
- [2] *Molecules* **2022**, 27(9), 2757
- [3] *Int. J. Mol. Sci.* **2017**, 18(3), 237

## Acknowledgements

This work was supported by the Russian Science Foundation (project No 23-73-10021).

## PREPARATION OF TARGETED DRUG DELIVERY SYSTEMS BASED ON COLLAGEN DERIVATIVES AND CHITOSAN USING VARIOUS CROSS-LINKING AGENTS

*Ryzhkova A.S.*<sup>1</sup>, *Makeeva A.A.*<sup>2</sup>, *Vernaya O.I.*<sup>1,2</sup>, *Semenov A.M.*<sup>3</sup>, *Shabatina T.I.*<sup>1,2</sup>

<sup>1</sup> Bauman Moscow State Technical University, Moscow, Russia

<sup>2</sup> Lomonosov Moscow State University, Chemistry Department, Moscow, Russia

<sup>3</sup> Lomonosov Moscow State University, Biology Department, Moscow, Russia

PhD student

[ryzhkova\\_as@mail.ru](mailto:ryzhkova_as@mail.ru)

An important direction of modern pharmacological research is the creation of systems that provide controlled release of the drug in target organs and tissues. Such dosage forms can be prepared by binding pharmacologically active components to a biopolymer matrix. Biopolymers are non-toxic and biodegradable, which favorably distinguishes them from their synthetic counterparts.

Low molecular collagen derivatives (LMCs): hydrolyzed collagen and gelatin are widely used in medical and food industries due to their good biological parameters [1]. Chitosan (deacetylated derivative of chitin) also has outstanding characteristics; it demonstrates hemostatic, mucoadhesive, and, among others, antibacterial properties [2].

In the present work, controlled release systems of the antibacterial drug dioxidine based on LMCs and chitosan were obtained. Dioxidine was used as a test drug because it has a wide range of treatment (from ENT diseases to infected burns) [3] and is easily traceable by UV spectroscopy due to its yellow staining.

Low-temperature methods were used to obtain dioxidine delayed-release systems. To determine the influence of synthesis conditions on the cryoforcing of the systems, the following conditions were changed: the degree of hydrolysis of LMC, its concentration (1.5 - 4.5 wt.%), the concentration of chitosan (1.5; 3%), and the type of crosslinking agent (sodium tripolyphosphate and glutaraldehyde).

The degree of influence of synthesis conditions on the structure, properties and composition of the obtained hybrid composites was evaluated by UV-, FT-IR spectroscopy and scanning electron microscopy (SEM). According to SEM micrographs, the hybrid matrices had a macroporous structure, unlike the single-component ones. For systems cross-linked with glutaraldehyde and containing gelatin and 1.5 wt.% chitosan, a tenfold (from tens to hundreds of  $\mu\text{m}$ ) increase in average pore diameter was observed with increasing gelatin concentration in the precursor solution. The dioxidine/gelatin/chitosan-3% and dioxidine/hydrolyzed collagen/chitosan systems did not exhibit a marked change in pore size with changing the concentration of collagen derivatives. In the case of dioxidine/gelatin/chitosan systems cross-linked with tripolyphosphate, the average pore diameter increased 1.5-3 times with increasing gelatin concentration in the precursor solution.

The introduction of chitosan into the targeted drug delivery system complicates the dependence of dioxidine release time on LMC concentration. The release time of the antibacterial component is independent of the concentration of hydrolyzed collagen in the dioxidine/hydrolyzed collagen/chitosan systems and increases with decreasing gelatin concentration in the dioxidine/gelatin/chitosan-1.5% (crosslinking agent glutaraldehyde) and dioxidine/gelatin/chitosan (crosslinking agent tripolyphosphate) systems. In the absence of chitosan in the system, the drug release time is directly proportional to the concentration of LMC in the precursor solution.

### References

[1] *Food Science and Technology*. **2017**, 76, 320-325

[2] *Polymers*. **2021**, 13, 3256

[3] *New drugs*, **1989**, 7.1, 78

### Acknowledgements

This work was carried out within the framework of the state assignment of M.V. Lomonosov Moscow State University, topic № AAAA-A21-121011590090-7. The authors express their gratitude to Stanislav Viktorovich Dvoryak and the Center for Collective Use "Nanochemistry and Nanomaterials" for their assistance in obtaining the SEM micrograph.

## CHARACTERIZATION OF NOVEL DENSE MEMBRANES BASED ON CHITOSAN MODIFIED BY MIL-125

*Salomatin K.A.<sup>1</sup>, Kuzminova A.I.<sup>1</sup>, Dmitrenko M.E.<sup>1</sup>, Dubovenko R.R.<sup>1</sup>, Selyutin A.A.<sup>1</sup>, Penkova A.V.<sup>1</sup>*

<sup>1</sup> St. Petersburg State University, St. Petersburg, Russia

Student

[st106790@student.spbu.ru](mailto:st106790@student.spbu.ru)

Recently, membrane processes have been experiencing rapid growth. At the same time, the industry requires effective materials based on biopolymers for separating mixtures used in various fields. Additionally, the issue of environmental sustainability is on the agenda, as the impact of industrial development on the environment becomes more and more significant. Therefore, industry is improving its manufacturing methods by utilizing novel technologies to enhance productivity and efficiency, while also making processes environmentally friendly and economically viable. Pervaporation is one such advanced and rapidly evolving membrane process used for separating low-molecular-weight components, azeotropic mixtures, and isomeric mixtures due to its outstanding characteristics: environmental friendliness, low energy consumption, and compact modular design. To enhance the transport properties of the membrane material, mixed matrix membranes (MMMs) have been developed. The process involves modifying the polymer matrix through the introduction of an inorganic compound, which leads to the crosslinking of the polymer fibers.

In this study, chitosan, a biopolymer, was selected for the development of novel, dense membranes for the separation of a water/isopropanol mixture. To modify the chitosan polymer matrix, metal-organic framework (MOF) MIL-125 was utilized. The structure and physicochemical properties of the resulting membranes were investigated using Fourier-transform infrared (FTIR) spectroscopy, scanning electron microscopy (SEM), atomic force spectroscopy (AFM), thermogravimetric analysis (TGA), swelling degree measurement, contact angle analysis, and nuclear magnetic resonance (NMR) spectroscopy. It has been demonstrated that the formation of MMMs results in a significant improvement in membrane transport properties, owing to significant alterations in the internal and surface structures of the membrane.

### **Acknowledgements**

The authors acknowledge Saint-Petersburg State University for a research project 11602266. The experimental work of this study was facilitated by the equipment from the Resource Centre of Geomodel, Chemical Analysis and Materials Research Centre, Centre for X-ray Diffraction Methods, Magnetic Resonance Research Centre, Centre for Innovative Technologies of Composite Nanomaterials, Nanophotonics Centre, Cryogenic department, Thermogravimetric and Calorimetric Research Centre and the Interdisciplinary Resource Centre for Nanotechnology at the St. Petersburg State University.

## DEVELOPMENT OF NOVEL MEMBRANE MATERIALS FOR EFFECTIVE WATER TREATMENT

*Shonin G.A.<sup>1</sup>, Savkina S.R.<sup>2</sup>, Serafimov V.V.<sup>3</sup>, Tverdokhleba A.R.<sup>4</sup>, Kuzminova A.I.<sup>1</sup>, Dubovenko R.R.<sup>1</sup>, Dmitrenko M.E.<sup>1</sup>, Penkova A.V.<sup>1</sup>*

<sup>1</sup>St. Petersburg State University, St. Petersburg, Russia

<sup>2</sup>First Moscow State Medical University, Moscow, Russia

<sup>3</sup>MAEI "Central Educational Institution" № 40 named after M.V. Serafimov, Ufa, Russia

<sup>4</sup>MEI "Lyceum 3 of Tractorozavodskiy district of Volgograd", Volgograd, Russia  
Students

[goshashonin@gmail.com](mailto:goshashonin@gmail.com), [savkinasofiya@list.ru](mailto:savkinasofiya@list.ru), [serafimovviktor8@gmail.com](mailto:serafimovviktor8@gmail.com),  
[Vremeni2007@gmail.com](mailto:Vremeni2007@gmail.com)

Development of effective techniques for water purification is an urgent task in the light of misuse and pollution of water resources. Membrane technologies represent a promising solution to successfully remove contaminants and pathogens, providing public access to safe sources of drinking water. Pervaporation is an effective method for the separation of mixtures of low molecular weight substances. This technology finds application in various industries including chemical, pharmaceutical and food industries as well as in scientific research. The advantages of pervaporation include the ability to concentrate and separate azeotropic mixtures that are difficult to fractionate by conventional methods. Ultrafiltration is a membrane process in which a liquid is filtered under pressure. The sieve-based separation process can remove macromolecules whose hydrodynamic radius are more than the pore size of the membrane.

The aim of this project is to develop novel membrane materials based on sodium alginate (SA) for pervaporation and polyacrylonitrile (PAN) for ultrafiltration for effective water purification. To improve the transport properties of mixed matrix membranes based on SA and PAN, d-metal oxide nanoparticles (ZnO and TiO<sub>2</sub>) were introduced into the polymer matrix.

The principle of separation in pervaporation is based on the different rates of sorption and diffusion of the mixture components through the membrane. An environmentally friendly polymer, SA, was chosen as the material for pervaporation membranes because of its good mechanical properties, reproducibility of transport characteristics, and commercial availability. The transport properties of the developed SA-based dense membranes were investigated in the dehydration of isopropanol. PAN was selected as the membrane material for the preparation of porous membranes. PAN is characterized by high chemical and thermal stability, low cost, resistance to many organic solvents and reproducible transport properties. Disadvantages of PAN include easy fouling with soluble molecules. The transport properties of porous membranes based on PAN were investigated in the ultrafiltration of aqueous dye solutions. The modification of the membranes with nanoparticles increases the separation efficiency and selectivity, which confirms the possibility of using the developed membranes for more energy-efficient separation of mixtures of low molecular weight components, as well as for tackling the problem of wastewater pollution by dyes used in the textile industry.

### Acknowledgements

The authors acknowledge Saint-Petersburg State University for a research project 11602266. The experimental work of this study was facilitated by the equipment from the Resource Centre of Geomodel, Chemical Analysis and Materials Research Centre, Centre for X-ray Diffraction Methods, Magnetic Resonance Research Centre, Centre for Innovative Technologies of Composite Nanomaterials, Nanophotonics Centre, Cryogenic department, Thermogravimetric and Calorimetric Research Centre and the Interdisciplinary Resource Centre for Nanotechnology at the St. Petersburg State University.

# EXPLORING CRYSTALLIZATION AND MELTING OF POLY(ARYL-ETHER-ETHER-KETONE) WITH FAST SCANNING CALORIMETRY

*Siaglova E.D.*<sup>1,2</sup>, *Piryazev A.A.*<sup>1,3</sup>, *Ivanov D.A.*<sup>1,3</sup>

<sup>1</sup> Sirius University of Science and Technology, Sochi, Russia

<sup>2</sup> Moscow Institute of Physics and Technology, National Research University, Dolgoprudny, Russia

<sup>3</sup> Lomonosov Moscow State University (MSU), Moscow, Russia

Student

[syaglova.ed@talantiuspeh.ru](mailto:syaglova.ed@talantiuspeh.ru)

The technique known as fast scanning calorimetry (FSC) on a chip enables rapid thermal measurements at high heating and cooling rates of up to  $10^5$  Ks<sup>-1</sup>. This method allows for the characterization of a sample's thermal behavior without inducing uncontrolled modifications during the heating process by kinetically bypassing chemical transformation of monomers. Additionally, FSC can distinguish processes such as phase transitions that occur close in temperature. Previous studies have demonstrated the effectiveness of this relatively new method in analyzing individual particles of energetic materials during rapid heating [1].

Significant progress has been made in recent years in the development of thermoplastic matrices for composite materials, with poly(aryl-ether-ether-ketone) (PEEK) emerging as a prominent polymer in this field. This polymer exhibits outstanding toughness, strength, and rigidity, along with exceptional resistance to chemicals and radiation. Its combination of properties, together with its long shelf life, imply that it could offer advantages over thermoset materials due to its ease of fabrication, reparability, and reprocessing capabilities [2].

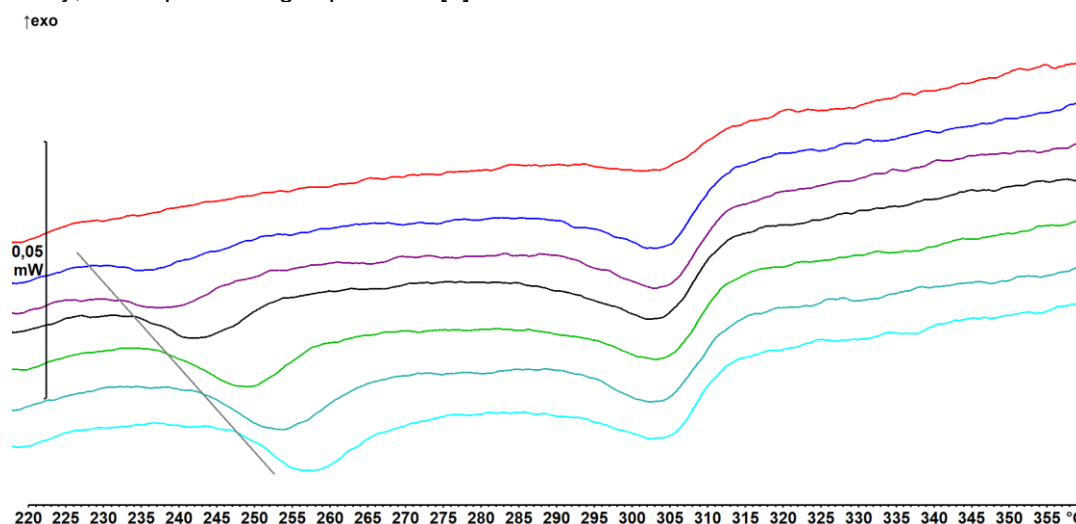

**Scheme 1.** FSC-curves depending on the crystallization time at 210°C (1-2-3-10-80-640-3600s from up to down).

The multiple-melting behavior observed in semi-rigid chain polymers like PEEK has been a topic of debate for over five decades, yet a definitive explanation for this phenomenon remains elusive. The double-melting behavior is observed for PEEK samples isothermally crystallized or cooled from the melt by classical DSC and FSC. The higher-temperature melting peak usually has an onset at 280-310°C which is not strongly affected by the sample's thermal history, while the lower-temperature melting peak onset strongly depends on crystallization conditions (Scheme 1). One of the simplest explanations of the double-melting behavior of PEEK would be the existence of two different polymorphs. However, no polymorphs in PEEK have ever been observed by X-ray diffraction [3].

## References

- [1] *Journal of synchrotron radiation* **2014**, 21(1), 223-228
- [2] *Journal of applied polymer science* **1988**, 36(5), 1097-1106
- [3] *Polymer* **1987**, 28(13), 2248-2251

## Acknowledgements

This work was supported by the Russian Science Foundation (project No 23-73-30005).

## TRENDS IN CHEMISTRY OF RESINS FOR CATHODIC ELECTRODEPOSITION COATINGS

*Silaeva A.A.<sup>1</sup>, Soldatov M.A.<sup>1</sup>, Malyavina Y.M.<sup>1</sup>, Rodnikov D.T.<sup>1</sup>*

<sup>1</sup> D.I. Mendeleev University of Chemical Technology of Russia, Moscow, Russia

Senior Lecturer, Ph.D. of Engineering Sciences

[silaeva.a.a@muctr.ru](mailto:silaeva.a.a@muctr.ru)

The cathodic electrodeposition method for producing paint and varnish coatings is one of the advanced methods for painting products with complex configurations, since it has a number of unique advantages. With this application method, a product of complex configuration is uniformly painted, even in difficult-to-reach areas, the method is fireproof, non-toxic for operators, capable of full automation, and material losses are minimal.

The coating is obtained in an aqueous solution when an electric current is applied due to the loss of solubility of the polyelectrolyte, which is the basis of the film-former for this material. Typical reactions are shown in scheme 1 [1].

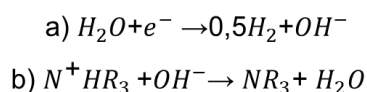

**Scheme 1.** Reactions on the cathode a) electrolysis of water b) deposition of amine containing oligomer

Resins used in cathodic electrodeposition materials differ significantly from standard resins for paint systems because they must meet a number of requirements. The film-forming agent must form a heterogeneous system in water, which is characterized by electrophoresis, and must also be capable of losing solubility in the cathode space. Equally important is the ability to form a corrosion-resistant coating, which is achieved with a certain structure of a three-dimensional mesh structure formed as a result of thermosetting. The most popular binders for e-coating obtained with acrylic or epoxy resins. This choice of resins is due to their excellent characteristics, in particular the high weather resistance and wear resistance of acrylic resins and the excellent adhesion and physical and mechanical characteristics of epoxy resins.

Several directions of technology development in the field of film-forming agents for cathodic electrodeposition can be identified. Resins for producing materials with improved chemical resistance, increased hydrophobicity and wear resistance; resins and film-forming systems with low-temperature curing ability; resins with increased corrosion resistance; resins modified with nano-sized fillers.

Coatings based on acrylic resins are used as a topcoat, so improvements in chemical resistance, hydrophobicity and weather resistance are desirable for such systems. Such effects are achieved by introducing monomer units containing fluorine and silicon, for example Dodecafluoroheptyl methacrylate, vinyltriethoxysilane beside classical monomers such as Butyl acrylate and methyl methacrylate [2-3]. The most common hardeners in cathodic electrodeposition materials are blocked isocyanates. Thus, the thermal curing process of coatings depends on the release temperature of the isocyanate hardener, which is usually in the range from 160 to 200 °C. An important goal in materials development is to reduce these temperatures. Thermal cure temperature reduction can be reduced in several ways: the use of highly active catalysts, the use of highly volatile blocking agents, and the use of isocyanate-free epoxy acrylate systems [4]. Modification of cathodic electrodeposition resins with nanosized particles is carried out by co-electrodeposition of metals or metal oxides together with polyelectrolyte reduction on the substrate [5]. Such compositions may have some special properties, including increased electrical conductivity and resistance to biodamage.

### References

- [1] I Krylova, Progress in Organic Coatings. **2001**, 42, 3–4, 119-131
- [2] Zheqing Gong, Wangting Zhao, Zhengrong Fu & Lijun Chen. New substances, materials, and coatings. **2023**, 59, 440–444
- [3] Lijun Chen, Wen Li, Wei Jiang. Pigment & Resin Technology. **2014**, 43, 5, 251-255
- [4] Chintankumar J. Patel, Ashok Dighe. Progress in Organic Coatings. **2007**, 60, 3, 219-223
- [5] A. A. Silaeva, et.al. *Russian Journal of Applied Chemistry*. **2018**, 91(2):337–341.



# PHOTO-SWITCHING OF IRON ALGINATE HYDROGEL VIA DIFFERENT WAVELENGTH LIGHT

*Sokolov A.S., Sukhorukov G.B.*

Skolkovo Institute of Science and Technology, Russia

PhD student

[Alexey.Sokolov@skoltech.ru](mailto:Alexey.Sokolov@skoltech.ru)

Alginates are natural linear anionic polysaccharides, that readily form cross-linked hydrogels upon coordination of their carboxylate groups with polyvalent metal cations. Due to their availability and biocompatibility these hydrogels founded a wide application as food products, industrial sorbents, drug-release systems, scaffold materials, etc.

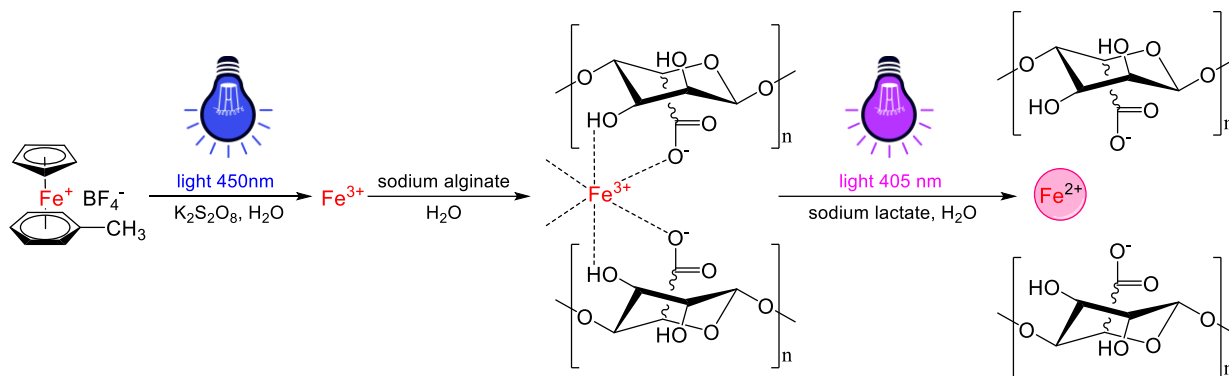

**Scheme 1.** Mechanism of photo-switching of alginate hydrogel

Despite the fact that the  $\text{Ca}^{2+}$  ion is usually used for cross-linking alginate molecules, we see the potential in iron alginate for several reasons. Firstly, iron ions  $\text{Fe}^{3+}$  and  $\text{Fe}^{2+}$  crosslink alginate molecules in the different way: at the same concentration,  $\text{Fe}^{3+}$  ions form an alginate gel, while  $\text{Fe}^{2+}$  ions do not [1]. Thus, by changing the charge of the iron ion, it is possible to change the physical properties of the gel (gelation and dissolution). Method of dissolution of iron alginate through a light-activated reaction ( $\lambda = 405 \text{ nm}$ ) have already been described [2]. Recently, we managed to photogelate alginate with  $\text{Fe}^{3+}$  iron ions through a fast photochemical reaction using a water-soluble photoactive iron complex ( $\lambda = 450 \text{ nm}$ ) [3]. Since these two reactions are activated by light of different wavelengths, we were able to combine both properties in one system. Thus, we have obtained the novel alginate hydrogel, the degree of cross-linking of which can vary through light irradiation (Scheme 1). Moreover, in some cases, iron alginate is a more preferable medium for cells than more wide spread calcium alginate [4], which opens up the scientific interest of using this photochemical system for encapsulation of not only drugs, but also living cells with opportunity to liberate them after a short light treatment.

## References

- [1] *Materials Advances* **2022**, 3(4), 1849-1873.
- [2] *Processes*, **2013**, 1, 153–166.
- [3] *Chemical Communications*, **2023**, 59(70), 10532-10535.
- [4] *International Scholarly Research Notices*, **2014**, 2014, 1-6.

## MODIFICATION OF NANOCRYSTALLINE CELLULOSE TO IMPROVE THE PROPERTIES OF BONE REPLACEMENT MATERIALS BASED ON POLY( $\epsilon$ -CAPROLACTONE)

*Solomakha O.A.*<sup>1</sup>, *Stepanova M.A.*<sup>1</sup>, *Gofman I.V.*<sup>1</sup>, *Dobrodumov A.V.*<sup>1</sup>, *Nashchekina Y.A.*<sup>2</sup>,  
*Nashchekin A.V.*<sup>3</sup>, *Korzhihova-Vlakh E.G.*<sup>1</sup>

<sup>1</sup> Institute of Macromolecular Compounds, Russian Academy of Sciences, St. Petersburg, Russia

<sup>2</sup> Institute of Cytology, Russian Academy of Sciences, St. Petersburg, Russia

<sup>3</sup> Ioffe Institute, St. Petersburg, Russia

Postgraduate

[solomanya@bk.ru](mailto:solomanya@bk.ru)

Among the various types of biodegradable polymers, poly( $\epsilon$ -caprolactone) (PCL) is the most promising and versatile. It is used to make suture threads and various fasteners for traumatology and orthopedics. The advantages of using such medical items are their biodegradability to non-toxic products, which are eliminated from the human body through metabolism. Production of PCL-based composites allows the improvement of the functional properties of the material and thus expands the prospects of their use, for example, for bone tissue engineering.

Nanocrystalline cellulose (NCC) can be used as a filler for PCL to impart cell adhesive properties and improve the mechanical parameters of PCL-based materials. However, the use of such hydrophilic filler does not improve the functional properties of the material due to its poor compatibility with the hydrophobic matrix. NCC modified with hydrophobic fragments as well as polyanions can improve the distribution of NCC in the PCL matrix on the one hand, and give these composites osteoconductive properties on the other hand. Given this, the aim of this work was the preparation of composite materials based on PCL and NCC modified with different polyanions such as heparin (Hep) or poly(glutamic acid) (PGlu).

In order to modify NCC with heparin (Hep), an amine-containing linker was first introduced into the heparin structure. Boc-ethylenediamine was chosen as the linker. Besides this, hexylamine was additionally introduced to heparin to impart amphiphilicity to this hydrophilic polymer. After the modification, the Boc protective groups of ethylenediamine moiety were removed. The success of the functionalization was confirmed by <sup>1</sup>H NMR spectroscopy. The degree of modification of heparin with ethylenediamine and hexylamine was 16 and 6%, respectively.

To modify NCC with poly(glutamic acid), Boc- $\epsilon$ -lysine units were first introduced into the PGlu structure to increase the content of amino groups necessary for modification of NCC. After the modification, the Boc protection was removed. The success of the modification was confirmed by <sup>1</sup>H NMR spectroscopy. The degree of modification of PGlu with lysine (PGlu-Lys) was 18%.

Prior to NCC functionalization, some of cellulose units were oxidized in order to generate aldehyde groups. In all cases, the NCC modification was carried out *via* reaction between the amino groups of functionalized polyanions and aldehyde groups of the oxidized NCC. Formed aldimine bonds and nonreacted aldehydes groups were reduced with sodium borohydride. The success of the modification of NCC with Hep and PGlu-Lys was confirmed by FTIR and solid-state <sup>13</sup>C NMR spectroscopy. The amount of Hep and PGlu-Lys conjugated to NCC was 153 mg/g and 127 mg/g, respectively.

Composite PCL-based films containing 10 wt% of modified NCC as a filler were produced. The surface morphology of the resulting materials was studied by optical and scanning electron microscopy. It was shown that better distribution of the NCC-Hep filler in films was observed, in contrast to NCC and NCC-PGlu-Lys. Mechanical properties in tensile tests showed a 15% decrease in elastic modulus for unmodified NCC used as filler compared to PCL films without filler. Similar effect was also observed for NCC-PGlu-Lys used as a filler to PCL. At the same time, the addition of NCC-Hep to the PCL matrix contributed to an 18% increase in elastic modulus. A study of biological properties demonstrated the absence of cytotoxicity of modified NCC towards osteoblast-like cells, improvement in adhesion and differentiation of mesenchymal stem cells (MSCs) towards the formation of calcium-containing deposits on the surface of the composite materials. Thus, NCC-Hep proved to be a promising filler for PCL-materials for bone tissue engineering, as it promotes the improvement of mechanical parameters of the composite, as well as adhesion of MSCs on the surface of composite materials and stimulation of biomineralization.

# HIGH-STRENGTH SELF-HEALING METALLOPOLYMERS OF ACRYLAMIDE AND ACRYLIC ACID

*Sorin E.S.<sup>1</sup>, Baimuratova R.K.<sup>1</sup>, Dzhardimalieva G.I.<sup>1,2</sup>*

<sup>1</sup> Federal Research Centre of Problems of Chemical Physics and Medicinal Chemistry RAS,  
Chernogolovka, Russia

<sup>2</sup> Moscow Aviation Institute, National Research University, Moscow, Russia  
Postgraduate  
[sorin\\_es@mail.ru](mailto:sorin_es@mail.ru)

Self-healing polymers are capable of restoring their original characteristics after damage. One of the most promising materials in this aspect are metallopolymers due to the inclusion of additional reversible metal-ligand interactions. In the majority of works such systems are obtained by impregnation of the finished polymer with salts of various transition metals, because of which it is not possible to achieve high strength characteristics [1-2].

This work proposes a one-step method for the preparation of new types of self-healing copolymers of acrylamide (AAm), acrylic acid (AAc) and metal chelate monomer based on 4'-phenyl-2,2':6',2''-terpyridine and acrylates of various transition metals [Co(II), Ni(II), Cu(II)]. The work presents a comparison of copolymers containing phenylterpyridine metal complex with copolymers containing metal acrylate, as well as with a model system (co-AAm-AAc). According to the results of mechanical tests, some samples have tensile strength over 120 MPa and elastic moduli over 5 GPA. The incorporation of the metal complex directly into the polymer chain has been shown to improve the mechanical properties of the final polymer films, as well as lead to intrinsic autonomous healing (Figure 1) [3].

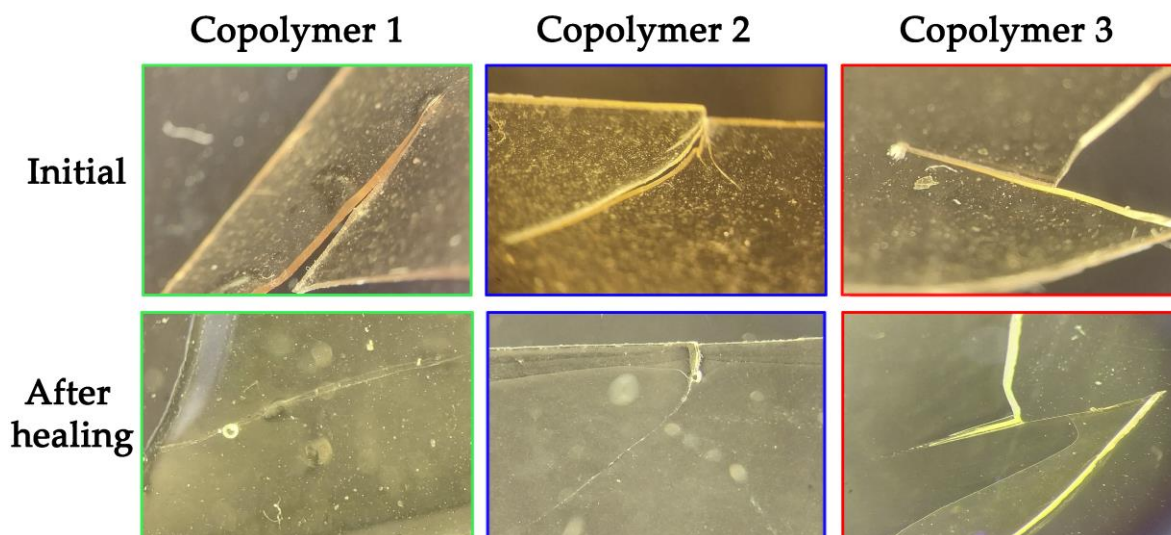

**Figure 1.** Autonomous intrinsic self-healing.

The self-healing properties demonstrated by all metallopolymer systems and the record values of maximum strengths, as well as the efficiency of mechanical properties recovery, demonstrate the prospect of using such materials as a basis for the creation of high-strength coatings of self-healing materials.

## References

- [1] *ACS Appl. Mater. Interfaces* **2020**, 12, 13239
- [2] *ACS Appl. Polym. Mater.* **2023**, 5, 9375
- [3] *Polymers* **2023**, 15, 1472

## Acknowledgements

This work was carried out in accordance with the state tasks, state registration No 124013000757-0, 124013000722-8, 124020800013-7.

## FILLERS AND MODIFIERS FOR POLYORGANOSILOXANES

*Srivastava A.A.<sup>1</sup>, Bondarev V.P.<sup>1</sup>, Kostyleva E.I.<sup>1</sup>, Ordina E.V.<sup>1</sup>, Kazarina O.V.<sup>2</sup>*

<sup>1</sup>Novomoskovsk institute Dmitry Mendeleev University of Chemical Technology of Russia, Novomoskovsk, Russia

<sup>2</sup>Lobachevsky State University of Nizhny Novgorod, Nizhny Novgorod, Russia  
Student, Laboratory assistant for chemical analysis of the Laboratory of Ion Materials by Novomoskovsk institute Dmitry Mendeleev University of Chemical Technology of Russia  
[svrivastava.a.a@muctr.ru](mailto:svrivastava.a.a@muctr.ru)

Filling and modification of polyorganosiloxanes is one of the most important areas of applied research. Currently, organosilicon liquids and rubbers make it possible to expand the temperature range of using materials based on them with prolonged exposure to temperatures from -90 to 350°C. Polyorganosiloxanes elastomers are widely used as insulating sealants and compounds due to their increased thermal and frost resistance, fire resistance, ability to ceramic formation, and high dielectric characteristics. The main disadvantage of silicone rubbers is their low strength characteristics. They can be increased by introducing reinforcing fillers into rubber [1,2].

In the present work, titanium dioxide was synthesized by hydrolysis of titanium tetrachloride in an alkaline medium in the ultrasonic field. Further, the resulting TiO<sub>2</sub> was doped with the following compounds: HfO(NO<sub>3</sub>)<sub>2</sub>, Ce(CH<sub>3</sub>COO)<sub>3</sub>. These salts were dissolved in a mixture of hydrochloric acid and hydrogen peroxide with concentrations of 0.36% and 3.8%, respectively. The solutions were stirred for 1 hour on a magnetic stirrer, gradually adding titanium dioxide. After that, the solution was filtered under vacuum, rinsed with water, then the obtained samples were annealed at 450 degrees for 2 hours. To characterize the obtained materials, the methods of IR-spectroscopy, laser diffraction, SEM, X-ray phase analysis, DTGA were used. The particle sizes of the initial TiO<sub>2</sub> are 0.08-0.14 microns, the average size of the doped particles decreases slightly and the fraction 0.05-0.07 microns prevails, the specific surface area of the particles is 15-25 m<sup>2</sup>/g.

The obtained particles of the initial and alloyed TiO<sub>2</sub> were studied as a reinforcing filler for polydimethylsiloxane rubber (SKTN) and their effect on thermal oxidative degradation and thermal stability of silicone uncured mixtures and rubbers based on them was studied.

Synthesized TiO<sub>2</sub> was introduced into rubber using a three-roll mixer so that its content in the system was 1-35%. A further increase in the filler concentration led to a deterioration in the strength characteristics of silicone rubbers. It was found that the stress at break ( $\sigma$ ) increases with increasing TiO<sub>2</sub> concentration from 0.7 to 2.5 MPa, the elongation ( $\epsilon$ ) increases from 110 to 145% ( $\omega$  (TiO<sub>2</sub>)= 25%), then decreases.

It was revealed that the synthesized alloyed TiO<sub>2</sub> particles are inhibitors of thermo-oxidative processes occurring in polyorganosiloxanes at elevated temperatures. The DTGA method determined the time of the onset of thermal oxidative degradation in filled crosslinked and uncured systems based on polydimethylsiloxane rubber with different filler content. The time of the beginning of gelation of SKTN was determined depending on the concentration of the modifying additive. It was revealed that synthesized TiO<sub>2</sub>-based systems significantly increase the thermal stability and thermal stability of polyorganosiloxanes.

### References

- [1] Russian Journal of Applied Chemistry. **2022**. 95. 8.
- [2] Polymer Degradation and Stability. **2020**. 171.

### Acknowledgements

This work was financially supported by Ministry of Science and Higher Education of the Russian Federation, Laboratory of ionic materials (LIM), project number FSSM-2024-0006.

## SMART POLYUREA-BASED SYSTEMS FOR UPSTREAM APPLICATIONS

*Stamer K.S.<sup>1</sup>, Baltaeva M.B.<sup>1</sup>, Orlov M.V.<sup>1</sup>, Wagle V.<sup>2</sup>*

<sup>1</sup> Aramco Innovations LLC, Moscow, Russia

<sup>2</sup> EXPEC ARC, Saudi Aramco, Dhahran, Saudi Arabia

Associate Petroleum Engineer

[katerina.stamer@aramcoinnovations.ru](mailto:katerina.stamer@aramcoinnovations.ru)

Intelligent materials, which underpin many applications in various fields, are designed to possess properties that can be significantly modified in a controlled manner by external stimuli. In this work, two systems based on polyurea capsules with different activation mechanisms have been developed and characterized for use in gas and oil production, namely, drilling and cementing wells.

The first system is a complex microcontainers (CMC) developed for cementing operations that consists of the polyol-containing polyurea microcapsules enclosed together with the isocyanate-based phase within the core of larger polyurethane microcapsules [1-2]. The CMC architecture allows to transport compartmentalized reaction mixture of the adhesive monomer and crosslinking agent and to provide the control of self-healing process. Healing occurs upon rupture of both types of capsules and release of both components which then contact each other. The possibility of an autonomous reaction between the adhesive monomer and polyol and the formation of polyurethane foam in the presence of water traces in the cement crack are the main benefits of the proposed system.

The second system consists of core-in-core morphological responsive microcapsules (RM). The inner part of the microcapsules consists of an epoxy resin hardener and a highly volatile solvent. The release of the epoxy resin hardener occurs under ultrasound trigger [3]. The RM is a component of "ACTIVISEAL," an advanced controlled technology for isolating fractures in drilling operations. Combination of on-demand activated material and the acoustic impulse generator is utilized for an effective sealing process in the fractured zone to reduce or prevent severe lost circulation while drilling [4].

The CMC system was obtained in a two-step process using oil-in-oil and oil-in-water emulsions creation following interphase polymerization. The two-step procedure is also the basis of the RM system preparation method, but a microfluidic device was used to enable the execution of procedures and experiments that are not feasible on a macroscale because of more precise phase control.

The synthesized materials were characterized by infrared spectroscopy and thermogravimetry to confirm the successful encapsulation of active agents and shell formation and to determine the core/shell ratio. Scanning electron microscopy was used to visualize the morphology of the systems. The analysis of the foam generated by the CMCs shows a significant initial volume increase, indicating the system's expandability. Examining the RM system breakdown under various ultrasound parameters reveals a high yield and efficient release of the curing agent.

It is expected that the resulting materials with different activation mechanisms will not only be used in oil and gas industry, but also become prototypes of future self-healing systems for other applications.

### References

- [1] Self-repairing cement including microcapsule-in-microcapsule material and designed swellable rubber and methods for fabrication same, US20230136906, 2023
- [2] SPE Middle East Oil and Gas Show and Conference, SPE-213702-MS, 2023
- [3] Ultrasonics, 2015, 58, 67-74
- [4] Methods of acoustically or electromagnetically activated well treatment, US20220235644, 2022

NOVEL NANOFILTRATION MEMBRANES BASED ON POLY(ESTER-BLOCK-AMIDE)  
MODIFIED BY METAL-ORGANIC FRAMEWORKS

*Stepanova A.S.*<sup>1</sup>, *Kuzminova A.I.*<sup>2</sup>, *Dmitrenko M.E.*<sup>3</sup>, *Dubovenko R.R.*<sup>4</sup>, *Penkova A.V.*<sup>5</sup>

<sup>1</sup> St. Petersburg State University, St. Petersburg, Russia

Student

[st113221@student.spbu.ru](mailto:st113221@student.spbu.ru)

Nanofiltration is a promising and environmentally friendly, rapidly developing method of liquid separation that does not require high-energy consumption and expensive equipment. The development of nanofiltration requires the search for new membrane materials, the transport properties of which are improved by creating mixed matrix membranes (MMMs) by modifying the polymer matrix with inorganic and/or organic filler.

In this study, novel poly(ester block amide)-based membranes were prepared by incorporating of the holmium-based metal-organic frameworks (MOFs), such as Ho-1,3,5-H<sub>3</sub>btc, Ho-1,2,4-H<sub>3</sub>btc, Ho-1,2-H<sub>2</sub>bdc, Ho-1,3-H<sub>2</sub>bdc, Ho-1,4-H<sub>2</sub>bdc, ZIF-67 etc. into the PEBA matrix. The properties of the obtained membranes were investigated by Fourier transform infrared spectroscopy (FTIR), scanning electron microscopy (SEM), atomic force microscopy (AFM) and thermogravimetric analysis (TGA), swelling experiments and measurement of contact angles. The transport properties of the obtained membranes were investigated during nanofiltration of dyes. It was found that the introduction of Ho-MOFs into the PEBA matrix led to changes in the structural, physicochemical, and transport properties of membranes. The tailored membrane properties were achieved due to the unique physicochemical and structural properties of the MOFs modifiers such as particle shape and pore size, thermal and chemical stability, large specific surface area and its ability to change the surface roughness, hydrophilic-hydrophobic balance, and swelling characteristics of dense PEBA membranes. The introduction of MOFs led to an increase in the permeability and rejection coefficients of dyes, which could be explained by the structure of modifiers, containing both hydrophilic and hydrophobic parts in the structure.

#### **Acknowledgements**

This research was funded by the Russian Science Foundation, grant №23-29-00473, <https://rscf.ru/project/23-29-00473/>. The experimental work of this study was facilitated by the equipment from the Resource Centre of Geomodel, Chemical Analysis and Materials Research Centre, Centre for X-ray Diffraction Methods, Magnetic Resonance Research Centre, Centre for Innovative Technologies of Composite Nanomaterials, Nanophotonics Centre, Cryogenic department, Computing Centre, Thermogravimetric and Calorimetric Research Centre and the Interdisciplinary Resource Centre for Nanotechnology at the St. Petersburg State University.

INFLUENCE OF THE METHOD FOR OBTAINING THE SOLVATE COMPLEX  $GdCl_3 \cdot n(i\text{-PrOH})$   
ON ITS PARTICLE SIZE AND ACTIVITY OF THE GADOLINIUM CATALYST  $GdCl_3 \cdot n(i\text{-PrOH}) \cdot Al(i\text{-Bu})_3$  IN THE POLYMERIZATION OF ISOPRENE

*Styazhkin D.V., Plotnikova N.V.*

Ufa Institute of Chemistry UFRC, Ufa, Russia

Postgraduate student

[styazhkin.dv@yandex.ru](mailto:styazhkin.dv@yandex.ru)

Catalysts based on gadolinium compounds stand out among the variety of lanthanide catalysts, since in their presence it becomes possible to obtain extremely highly stereoregular polyisoprene [1], which is as close in structure as possible to natural rubber, i.e., containing only 1,4-*cis* units in the main chain. It has been shown that the involvement of a catalyst based on the solvate complex  $GdCl_3 \cdot n(i\text{-PrOH})$  in the polymerization of isoprene allows one to obtain polyisoprene containing up to 99.2% 1,4-*cis* units, while the use of a neodymium catalyst prepared using the same technology allows one to obtain polyisoprene containing no more than 98% 1,4-*cis* units [2]. It is known [3] that changes in the size of solvate particles, among all other factors, significantly affect the activity of catalytic systems. At the same time, a change in particle size can be achieved by intensifying the process of complexation of the solvate using various methods - hydrodynamic impact in turbulent flows, ultrasonic irradiation, etc. Thus, establishing correlations between the method of preparing solvate complexes  $GdCl_3 \cdot n(i\text{-PrOH})$ , the size of their particles and the activity of catalysts prepared on their basis determines the goal of this work.

Solvation was carried out in a liquid paraffin environment at a molar ratio of  $GdCl_3 : i\text{-PrOH} = 3$  and an initial particle size of  $GdCl_3 = 181 \div 355$  nm. The particle size of the solvate complex decreases for some time after the dispersing effect and reaches a certain constant value. Solvation both under the influence of mechanical stirring for 8 hours and under constant ultrasonic influence on the solvate for 8 hours leads to the formation of a homogeneous complex characterized by an average modal particle size of the solvate of 112 nm. Catalysts prepared on the basis of these solvates are also characterized by comparable activity - 65÷75% for 3 hours of polymerization ( $[Gd] = 5$  mmol,  $Al/Gd$  molar ratio = 12, hereinafter - in all catalysts).

The hydrodynamic impact on the solvate complex in a tubular turbulent apparatus after an hour of solvation leads to the formation of a heterogeneous complex characterized by a polymodal distribution, and the catalyst prepared on the basis of this solvate has low catalytic activity. Solvation for 4 hours followed by hydrodynamic impact on the solvate leads to the formation of two types of particles with sizes of 56 and 141 nm. Catalysts prepared on the basis of these solvates are characterized by higher activity - 80÷85% for 3 hours of polymerization.

The multiplicity of hydrodynamic impacts on solvates also makes it possible to increase the activity of catalysts prepared on their basis. Thus, a single hydrodynamic impact on a solvation complex in a tubular turbulent apparatus leads to the formation of two types of particles characterized by different sizes - 71 and 141 nm. Double impact makes it possible to slightly improve the dimensional characteristics: in this case, particles with sizes of 56, 71 and 141 nm are formed. At the same time, the activity of the gadolinium catalyst prepared on the basis of this solvate is the highest and amounts to 90÷100% for 3 hours of polymerization. It is worth noting that a further increase in the multiplicity does not affect the activity of the catalyst. The combination of the "double hydrodynamic impact-ultrasonic irradiation" methods expectedly led to the production of solvates with higher dimensional characteristics, as well as to lower activity of catalysts based on them.

Thus, the highest activity of gadolinium catalysts in the polymerization of isoprene is achieved in the case of using solvate complexes  $GdCl_3 \cdot n(i\text{-PrOH})$  twice subjected to hydrodynamic impact in a tubular turbulent apparatus, and a large multiplicity of hydrodynamic impact has no effect on the activity.

### References

- [1] *Macromol. Rapid Commun.* **2003**, 24, 179
- [2] *Russ. J. Appl. Chem.* **2022**, 95, 1573
- [3] *Russ. J. Gen. Chem.* **2023**, 93, S327

### Acknowledgements

This work was supported by the Russian Science Foundation (project No 23-13-20024).

## INTERACTION BETWEEN CHITOSAN AND ALBUMIN IN WEAKLY ALCALINE MEDIA

*Tishchenko N.A.*<sup>1</sup>, *Vyshivannaya O.V.*<sup>1,2</sup>, *Tikhonov V.E.*<sup>1</sup>, *Bezrodnykh E.A.*<sup>1</sup>, *Piskarev V.E.*<sup>1</sup>,  
*Aysin R.R.*<sup>1</sup>, *Antonov Y.A.*<sup>3</sup>, *Orlov V.N.*<sup>4</sup>, *Blagodatskikh I.V.*<sup>1</sup>

<sup>1</sup> A.N. Nesmeyanov Institute of Organoelement Compounds, Russian Academy of Sciences,  
Vavilova St. 28, bld. 1, Moscow, 119334 Russia

<sup>2</sup> Faculty of Physics, Lomonosov Moscow State University, Leninskie Gory 1-2, Moscow,  
119991 Russia

<sup>3</sup> N.M. Emanuel Institute of Biochemical Physics, Russian Academy of Sciences, Moscow,  
119334  
Russia

<sup>4</sup> A.N. Belozersky Research Institute of Physico-Chemical Biology MSU, Leninskie Gory, 1-40,  
Postgraduate  
[nik\\_1456@mail.ru](mailto:nik_1456@mail.ru)

Chitosan is a natural polysaccharide with unique properties, such as biocompatibility, biodegradability, and antimicrobial activity. These properties make it a promising polymer for creating polysaccharide-protein composites. However, one significant limitation for such systems is the loss of solubility of chitosan above pH 6.2-6.5. Partial homogeneous reacetylation of short-chain chitosan (RA-CHI), with an optimal degree of acetylation leading to a statistical distribution of acetyl glucosamine units along the chain not only increases its solubility and aggregative stability in slightly alkaline media, but also results in an enhanced antimicrobial activity at these conditions [1]. Therefore, the interaction between RA-CHI and bovine serum albumin (BSA) at pH 7.4 is of particular interest. Using isothermal titration calorimetry (ITC), we show that the process of protein-chitosan interaction is dependent on the heat of buffer ionization (figure 1). This observation suggests that electrostatic interaction plays a major role in the binding mechanism, which is accompanied by the transfer of protons from the buffer substance to chitosan. Increasing the ionic strength of the buffer to 0.15 M NaCl suppresses complexation.

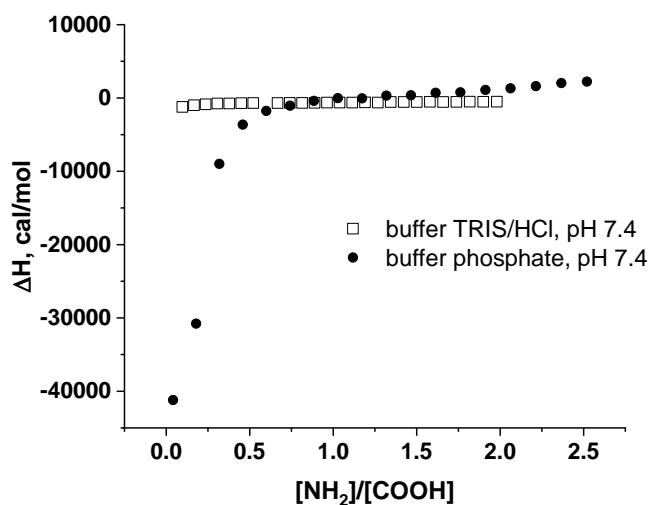

**Figure 1** . ITC results in buffers with different ionization enthalpies ( $\Delta H_i(\text{TRIS}) = 11$  kcal/mol,  $\Delta H_i(\text{PHOS}) = 0.9$  kcal/mol ).

It has been shown by the methods of circular dichroism and micro-FTIR spectroscopy that the formation of a chitosan-protein complex does not cause a change in the secondary structure of the protein. Increasing the degree of acetylation of chitosan from 24% to 40% results in a decrease in its affinity to BSA and in a shift in the binding mechanism from predominantly electrostatic to predominantly hydrophobic.

### References

[1] *Biomacromolecules*. **2017**, 18, 1491

### Acknowledgements

This work was supported by the Russian Science Foundation (project No. 23-23-00198).



# ENZYMATIC HYDROLYSIS AS A NEW WAY FOR STARCH NANOCRYSTALS PREPARATION

*Tryakhov D.E.*<sup>1</sup>

<sup>1</sup> Institute of Solid state chemistry and mechanochemistry, Novosibirsk, Russia

PhD student

[tryakhovd@gmail.com](mailto:tryakhovd@gmail.com)

Nanoparticles based on starch biopolymers are widely used in areas such as nanomedicine, polymer materials strengthening and emulsions stabilizing [1]. Despite the low cost of the starting material, renewability, biocompatibility and the ability to control electrokinetic properties, starch nanoparticles remain only a laboratory sample and do not have any industrial analogue. The main obstacle to the widespread use of starch nanoparticles is the labor-intensive method of their isolation. This method is based on the hydrolysis of native starch granules with mineral acids, while the acid selectively hydrolyzes the amorphous regions of the granules without affecting the nanocrystalline lamellae. The most attractive way to solve this problem is to replace acid hydrolysis with enzymatic hydrolysis. Enzymes are available and safe substances for the hydrolysis of starch. However, due to the large size of the enzyme molecule, it is not able to penetrate into the granule and provide selective hydrolysis of the amorphous phase; as a result, it has not been used previously.

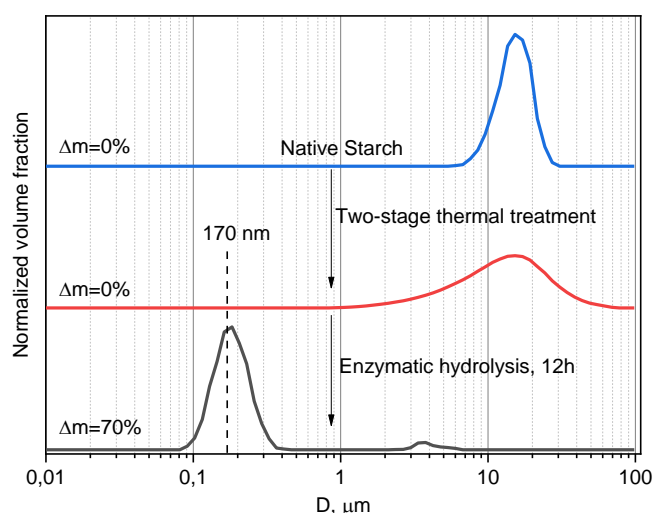

**Figure 1.** The particle size distribution of native, thermally treated and enzymatically hydrolyzed maize starch (top down).

This work proposes the use of two-stage thermal pretreatment of starch to partially dissolve the internal regions of native starch granules and destroy their native granular structure. We have developed a technique that allows the use of enzymatic hydrolysis to isolate starch nanocrystals. The study showed that starch nanocrystals can be obtained within 12 hours without the use of acidic media (Figure 1). The optimization of the pre-treatment technique was carried out, and the thermal stability of the crystalline phase of native and thermally treated starch was studied. The resulting starch nanocrystals were characterized by SLS, DLS, XRD and DSC methods.

## References

[1] *International Journal of Biological Macromolecules*. **2024**, 130746.

## Acknowledgements

The research was funded within the state assignment to ISSCM SB RAS (project No. 122011700261-3).

## FUCOIDAN/NANOCHITIN MICROGELS FOR VAGINAL DELIVERY OF METRONIDAZOLE

*Ustyukhina I.S.<sup>1,2</sup>, Dubashynskaya N.V.<sup>1</sup>, Petrova V.A.<sup>1</sup>, Skorik Y.A.<sup>1</sup>*

<sup>1</sup>Institute of Macromolecular Compounds of the Russian Academy of Sciences, St Petersburg, Russia

<sup>2</sup>ITMO University, St Petersburg, Russia

MS Student

[iustyukhina@niuitmo.ru](mailto:iustyukhina@niuitmo.ru)

The formation of a biopolymer delivery system based on polysaccharides with active functional groups, such as fucoidan and partially deacetylated chitin (nanochitin or chitin nanowhiskers), allows to increase the efficiency of local drug delivery due to high mucoadhesion to the mucosal surface as well as a modified drug release profile. Due to the electrostatic interaction between the functional groups of the oppositely charged fucoidan and nanochitin, a polyelectrolyte complex (PEC) is formed in the form of a microgel, which is a matrix for loading the antiprotozoal drug metronidazole [1-3].

In this study, we aimed to develop a vaginal metronidazole delivery system with enhanced mucoadhesion and prolonged drug release profile using fucoidan and nanochitin. The resulting systems in the form of PECs have hydrodynamic diameters of 244 and 816 nm and  $\zeta$ -potential of about -22 mV. The mucoadhesion experiment showed that the different ratios of the system components affect the properties of the resulting microgel. The system prepared with a 1:2 polymer ratio has improved binding properties of free mucin and is thus better adsorbed to the mucosal surface.

Metronidazole release data from the polymer matrix confirmed the hypothesis of modified release of the developed system in a low acid pH 4.5 environment. Sustained and uniform release of the antibacterial drug from the polymer matrix was also observed in a neutral pH 7.4 environment, suggesting that the developed system can be used in the physiological pH range. The incorporation of metronidazole into PEC particles promoted sustained drug release for 10 h and also maintained antiprotozoal activity against clinical isolates of *Trichomonas vaginalis* for 10 h.

The sustained drug release rate, combined with pronounced mucoadhesive properties and improved pharmacological activity, make the developed biopolymer delivery systems promising candidates for further clinical trials.

### References

- [1] *Energy & Environmental Materials*. **2020**, 3. – 4, 492-515
- [2] *International Journal of Molecular Sciences*. **2023**, 24. – №. 3. – P. 2615
- [3] *Materials*. **2022**, 15, 17. 5860

# COMPUTER SIMULATIONS OF AMPHIPHILIC STIMULI-RESPONSIVE MICROGELS WITH HYDROPHOBIC MACRO-CROSSLINKERS

*Uzhegov A.A.<sup>1</sup>, Gumerov R.A.<sup>1</sup>, Rudyak V. Yu.<sup>2</sup>, Potemkin I. I.<sup>1</sup>*

<sup>1</sup> Lomonosov Moscow State University, Moscow, Russian Federation

<sup>2</sup> Tel Aviv University, Tel Aviv, Israel

Student

[uzhegov@polly.phys.msu.ru](mailto:uzhegov@polly.phys.msu.ru)

Nano- and microgels are soft polymer particles with a network structure which combine the properties of solid colloids, polymers and surfactants, thus offering a wide range of applications including liquid purification, emulsion stabilization, pattern formation, and most notably, targeted drug delivery [1]. In the latter context, the crucial role lies in particles' ability to change their shape, size, softness and porosity in response to external stimuli such as temperature or pH. Here the inclusion of various functional groups allows for the absorption and release of specific "guest" molecules. Although the effectiveness of microgels has been demonstrated in both *in vitro* and *in vivo* studies for many medications, there is still a challenge in encapsulating hydrophobic drugs within the polymer network.

Amphiphilic microgels, containing both hydrophilic and hydrophobic monomer units, offer a solution by forming hydrophobic domains ("pockets") for drug accumulation while maintaining overall hydrophilicity for colloidal stability and sensitivity to external stimuli. In turn, the biodegradability of the hydrophobic pockets enables a controlled release of absorbed molecules. Despite the apparent potential of amphiphilic stimuli-responsive microgels for biomedical use, currently there are only few examples available [2-3].

This study aims to examine the properties of amphiphilic stimuli-responsive particles based on N-isopropylacrylamide and hydrophobic macromonomers. The latter is represented by biodegradable star-shaped oligo( $\epsilon$ -caprolactone) (starOCL) crosslinkers. Initially, an *in silico* synthesis of the amphiphilic networks mimicking the actual dispersion polymerization process was performed [4]. Then, the swelling behavior of the resulting particles was studied using molecular dynamics simulations. Finally, the ability to encapsulate hydrophobic guest molecules and to release them during crosslinker degradation has been demonstrated. Our results may be useful in the obtainment of biocompatible soft carriers for the efficient drug delivery.

## References

- [1] Langmuir **2019**, 35, 6231
- [2] Polymer **2019**, 172, 283
- [3] Journal of colloid and interface science **2020**, 564, 344
- [4] Scientific reports **2019**, 9(1), 13052

## Acknowledgements

This work was supported by the Russian Science Foundation (project No 24-43-10004).

# ACRYLAMIDE AND DIALLYLAMINE HYDROCHLORIDE COPOLYMERS FOR IMPROVING THE STRENGTH CHARACTERISTICS OF RECOVERED PAPERBOARD

*Vihireva A.D.<sup>1</sup>, Vdovina O.S.<sup>1</sup>, Shirshin K.V.<sup>1,2</sup>*

<sup>1</sup>HOMA Group, Dzerzhinsk, Russia

<sup>2</sup>Nizhny Novgorod State Technical University n.a. R.E. Alekseev, Nizhny Novgorod, Russia  
Young Scientist

[vihireva2000@gmail.com](mailto:vihireva2000@gmail.com)

Given the current environmental policy, the pulp and paper industry should focus on the use of secondary raw materials in the production of paper and paperboard. This entails some technological difficulties, such as reduced strength performance of paper and paperboard, low fiber retention on the screen table of paper machine, high cation demand of recovered paper pulp, poor forming quality and dewatering rate of paper web, etc. To solve the above problems, special polymeric materials are increasingly used, so their research and development is an urgent task at present.

Polyacrylamides, specifically cationic acrylamide polymers, have long been known and widely used in this field. The cellulose fibers and impurities in recovered paper pulp have a natural anionic charge. The presence of cationic groups in the polymer allows it to attract as many anionic contaminants (impurities) as possible. Various monomers containing a positively charged ammonium group are used as a cationic co-monomer, in particular an allyl monomer such as diallylamine hydrochloride is of interest. A feature of allyl monomers is the presence of a labile C–H bond in the methylene group at the  $\alpha$ -position to the double bond, making them active chain transfer agents in radical polymerization [1,2].

The purpose of this work is to develop the technology of acrylamide and diallylamine hydrochloride copolymer solution to improve the strength of waste paperboard.

Laboratory samples of acrylamide copolymers with diallylamine hydrochloride of different compositions were synthesized by radical polymerization in aqueous solution. The molecular weight characteristics of the obtained samples were analysed by size-exclusion chromatography and the composition of the copolymers was confirmed by IR spectroscopy. A special place in the conducted studies was occupied by the analysis of the efficiency of synthesized polymer solutions in terms of hardening, dehydration and retention. The influence of molecular weight and copolymer composition on the strength characteristics of paper and paperboard, as well as on the paper moulding performance was studied. It was determined that in the range of monomer composition investigated, samples with 22,4 mol.% content of diallylamine hydrochloride in the initial monomer mixture had the highest efficiency. The polymer with this cationic monomer content showed the best paper pulp dewatering time, the highest retention on the mesh and a good increase in paper strength properties. The existence of a range of optimal molecular weight of the copolymer, providing the best moulding conditions and processability of this polymer, was also noted.

The results of the conducted studies allowed to choose the optimal formulation and synthesis mode of acrylamide and diallylamine hydrochloride copolymer solution. Its use makes it possible to significantly accelerate the process of paper pulp dewatering, improve the retention of fine fibres, fillers and impurities on the screen table and increase the strength properties of paper and paperboard.

## References

[1] Kudyshkin V.O., Vokhidova N.R., Rashidova S.Sh. Regulation of radical polymerisation under conditions of weak inhibition. Publishing house "Fan" of the Academy of Sciences of the Republic of Uzbekistan, 2016. 192 p.

[2] Rabiee A., Ershad-Langroudi A., Zeynali M.E. A survey on cationic polyelectrolytes and their applications: acrylamide derivatives // Reviews in Chemical Engineering. 2015. Vol. 31, № 3.

# ONE- POT PREPARATION OF METAL – POLYMER NANOCOMPOSITE IN IRRADIATED SOLUTION $\text{HAuCl}_4$ AND 1-VINYL-1,3-IMIDAZOLE: FEATURES FORMATION OF GOLD NANOPARTICLES AND 1-VINYL-1,3-IMIDAZOLE POLYMERIZATION

*Vinogradov R.A.<sup>1</sup>, Zharikov A.A.<sup>1</sup>, Zezina E.A.<sup>1</sup>, Pozdnyakov A.S.<sup>3</sup>, Zezin A.A.<sup>1,2</sup>*

<sup>1</sup>Department of Chemistry, Lomonosov Moscow State University, Moscow 119991, Russia

<sup>2</sup>Enikolopov Institute of Synthetic Polymeric Materials, Russian Academy of Sciences, Moscow, 117393, Russia

<sup>3</sup>Favorsky Irkutsk Institute of Chemistry, Siberian Branch of the Russian Academy of Sciences, Irkutsk 664033, Russia

Student

[vinogr.rodion@gmail.com](mailto:vinogr.rodion@gmail.com)

Unique optical, electronic and catalytic properties of gold nanoparticles (AuNPs) are the reason for the ongoing interest in AuNPs-based materials. A common method for obtaining AuNPs is the reduction of Au(III) ions by various reducing agents. However, NPs tend to aggregate if they are not stabilized. Poly(1-vinylimidazole) (PVI) is a biocompatible, non-toxic and pH-sensitive polymer, that exhibits excellent ability to stabilize AuNPs. In this work, chemically pure PVI-stabilized AuNPs were synthesized in solutions of monomer (1-vinylimidazole) containing Au(III) ions in one step. An undoubted advantage of this approach is the possibility of preparation of PVI-AuNPs nanocomposites without the use of any chemical reducing agents and initiators of polymerization, since in our case, the reduction of Au(III) ions and polymerization of VI are provided by radical species resulting from the radiolysis of aqueous-ethanol medium [1,2].

The current work is concerned with the effect of Au(III) concentration on the kinetics of radiation-induced formation of PVI and AuNPs. The samples were irradiated by X-rays using a 5-BKhV-6W tube with tungsten anode (applied voltage was 45 kVp, anode current ca. 80 mA) at 293 K in polypropylene Eppendorf test tubes of 8 mm thick. Such conditions ensured uniform generation of radiolysis products in the volume (the dose rate was 1,4 kGy/min). The data of UV-Vis spectroscopy showed that the polymerization of VI and formation of AuNPs occurs in the same range of the absorbed doses for solutions with the  $[\text{Au(III)}]/[\text{VI}]$  ratio of 1/20, 1/40, 1/80. Based on the TEM results, we can conclude that the resulting PVI macromolecules effectively stabilize gold nanoparticles. Moreover, in each of the studied systems, the average sizes of nanoparticles do not exceed 5-7 nm (fig. 1).

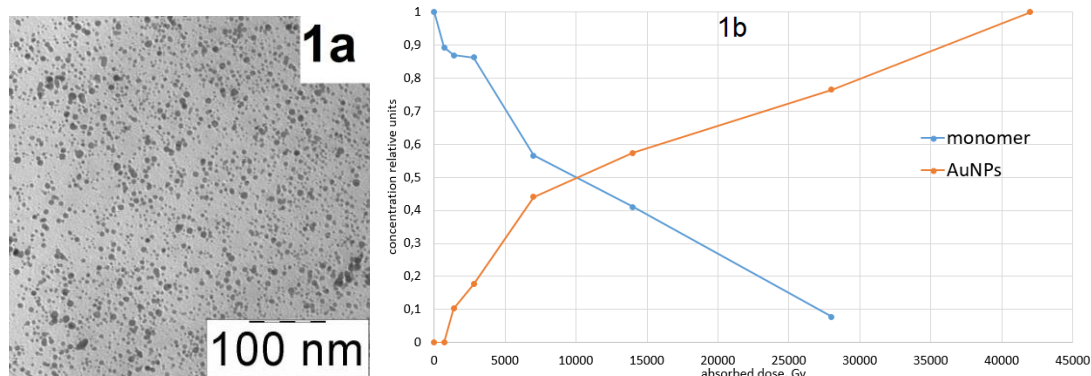

**Figure 1.** a-TEM image of 1/40 system, b-kinetics of AuNPs formation and polymerization of 1/40 system

## References

[1] Polymers. 2021. V.13. P. 4235.

[2] Polymers. 2022. V.21. P. 4601.

## Acknowledgements

This work was financially supported in part by the Russian Science Foundation (project no 22-73-00054).

# STRUCTURE AND PROPERTIES OF INCLUSION COMPLEXES OF AMYLOSE WITH FATTY ACIDS

*Voroshnina A.A.*<sup>1</sup>

<sup>1</sup>Institute of Solid State Chemistry and Mechanochemistry SB RAS, Novosibirsk, Russia

PhD student

[voroshnina@solid.nsc.ru](mailto:voroshnina@solid.nsc.ru)

Amylose is a linear  $\alpha$ -D-glucose polymer bound by  $\alpha(1\rightarrow4)$  glycoside bonds. One of the most important properties of this polysaccharide is the possibility of formation of inclusion complexes and further crystallization in the presence of various organic and inorganic complexing agents (V-amylose). Such amylose complexes have a spiral structure, due to which they are able to form crystals with unique properties such as resistance to enzymes, insolubility in water and others. Crystalline V-amylose have potential applications in pharmaceutical industry for the encapsulation of bioactive molecules and also as prebiotics.

Since about 20-30% of amylose is present in native starch, the most economical and scalable way to obtain this polysaccharide is to isolate amylose in an aqueous starch suspension at temperatures close to the gelatinization temperature (leaching). Preliminary infrared heating up to 200 °C allowed to intensify the process of amylose isolation from potato starch. Analysis of gel penetrating chromatography data shows that the resulting amylose was effectively separated from amylopectin impurities (leached polymers had molecular weight does not exceed 800 kDa, which corresponding to amylose molecules).

In this work, complexes of inclusion of amylose leached from heat-treated potato starch and stearic acid were obtained. The reaction was carried out at 90 °C for 24 hours, followed by cooling to room temperature, which ensured the maximum yield of V-amylose crystal complexes. X-ray phase analysis demonstrates the formation of complexes with a V-type crystal structure (Figure 1).

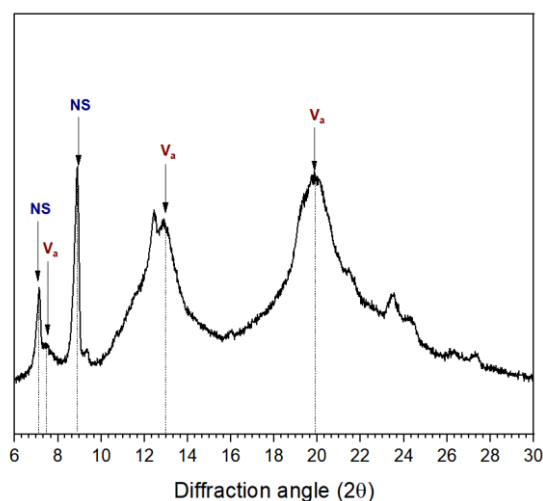

**Figure 1.** X-ray diffraction spectra of amylose-stearic acid complexes ( $V_a$ ) and sodium stearate (NS).

## Acknowledgements

The research was funded within the state assignment to ISSCM SB RAS (project No. 122011700261 - 3).

# ACYCLIC DIAMINOCARBENE PALLADIUM(II) COMPLEXES AS SUZUKI POLYCONDENSATION CATALYSTS

*Yakimanskiy A.A., Zhukova E.V., Kashina A.V., Chulkova T.G., Yakimansky A.V.*

Institute of Macromolecular Compounds, St. Petersburg, Russia

Postgraduate student

[yakimanskii@gmail.com](mailto:yakimanskii@gmail.com)

Acyclic diaminocarbene (ADC) palladium(II) complexes showed great performance as catalytic systems for the Suzuki cross-coupling reaction [1, 2]. The key to such success is the combination of very high catalytic activity with good stability in the presence of both water and oxygen. In contrast, palladium(0) phosphine complexes, which are widely used in the Suzuki polycondensation reaction, require an inert atmosphere [3].

As long as ADC Pd(II) complexes show high catalytic activity in the model Suzuki coupling reaction, it is the matter of high interest to apply them in the Suzuki polycondensation reaction to obtain  $\pi$ -conjugated polymers.

We studied the Suzuki polycondensation under microwave irradiation in one-phase (ethanol) and two-phase (toluene-water) systems. For the two-phase system, we used dibromo comonomers, which have different reactivity in the Suzuki reaction. As a result, a series of copolyfluorenes were obtained with high yields. Their molecular weight characteristics and photophysical properties were studied.

We also compared the physicochemical characteristics and luminescent properties of copolyfluorenes obtained with the use of Pd(0)(PPh<sub>3</sub>)<sub>4</sub> (under argon atmosphere) and ADC Pd(II) complexes (in the presence of oxygen) (Scheme 1).

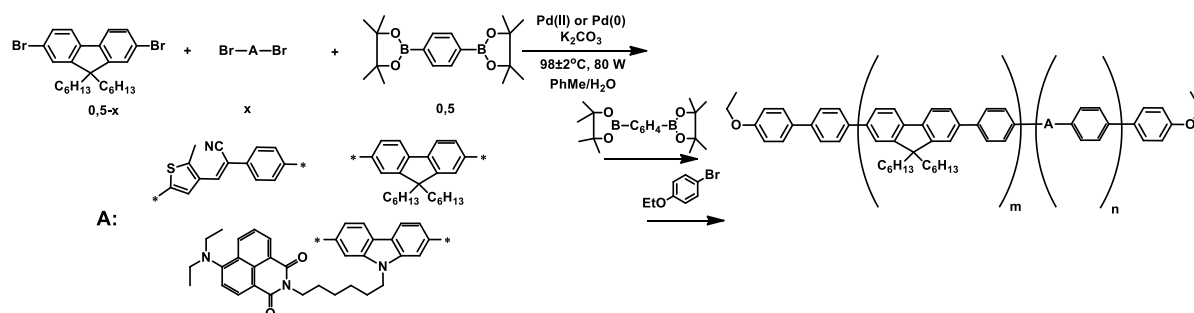

**Scheme 1.** Suzuki polycondensation.

## References

- [1] *Organometallics* **2009**, 28, 6559
- [2] *Adv. in Organometallic Chem. and Cat.* **2014**, Ch.11, 145
- [3] *Synth. Methods for Conjugated Polymers and Carbon Mat.* **2017**, Ch. 2, 59

## Acknowledgements

This work was supported by the Russian Science Foundation (project No 23-43-00060).

# STRUCTURAL BEHAVIOR OF AQUEOUS AND AQUEOUS-SALT SOLUTIONS OF POLYMERIZED IMIDAZOLIUM IONIC LIQUID

*Yarchenko P.S.<sup>1</sup>, Safonova E.A.<sup>1</sup>*

<sup>1</sup>St. Petersburg State University, St. Petersburg, Russia

Student

[st090345@student.spbu.ru](mailto:st090345@student.spbu.ru)

Ionic liquids are molten salts based on organic ions. Due to their structural specificity, these substances are liquid in a wide temperature range. Some special physicochemical properties (such as high thermal stability, very low, almost zero, vapor pressure, high polarity, high electrical conductivity, etc.) determine a wide range of their applications. Polymerized ionic liquids, polyelectrolytes, whose monomers are ionic liquids, are of particular practical interest [1].

The aim of this work is to study the structural behavior of aqueous and aqueous-salt solutions of polymerized imidazolium ionic liquid, poly-(1-butyl-3-vinyl imidazolium) bromide (p-BVImBr). The polyelectrolyte is synthesized in our laboratory by the reaction of free radical polymerization of the monomer, bromide 1-butyl-3-vinyl imidazolium (**Scheme 1**). The molecular weight of the polymer (100 kDa) was estimated by static light scattering. The following properties of solutions have been determined: density, viscosity, surface tension, translational diffusion coefficient and hydrodynamic radius of macromolecules.

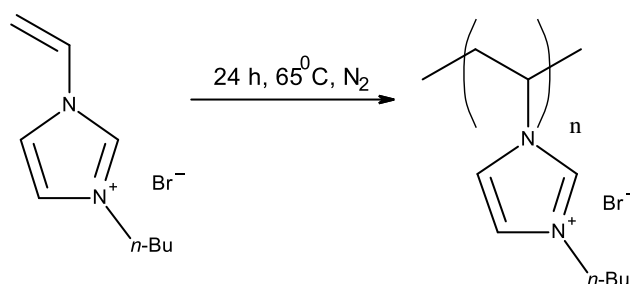

**Scheme 1.** Synthesis of poly-(1-butyl-3-vinyl imidazolium) bromide

The Wilhelmy plate method was applied to determine the values of surface tension at the solution-air interface. It has been shown that p-BVImBr is surface active polymeric compound, and the equilibrium value of surface tension changes in the presence of salt.

By the method of dynamic light scattering (photon correlation spectroscopy), translational diffusion coefficients of macromolecules were determined and the hydrodynamic radii were calculated.

Concentration dependencies for two series of water-salt solutions of p-BVImBr were studied. When considering the dependence of the reduced viscosity on the concentration of the polyelectrolyte, the equations of Huggins and Cramer were used. The values of characteristic viscosity proportional to the volume of particles were estimated. It has been found that the characteristic viscosity increases with decreasing salt concentration. At 0.1 M KBr, the dynamic viscosity values are significantly higher than in case of the solutions at 0.5 M KBr. At 0.1 M salt content, the diffusion coefficients decrease with a decrease in the concentration of polyelectrolyte in the solution (the hydrodynamic radius increases), what likely indicates an unfolding of the backbone. However, at 0.5 M KBr, the diffusion coefficients increase as the concentration of polyelectrolyte in the solution decreases. Furthermore, based on the viscosity data, the system can be characterized as an uncharged polymer in a good solvent.

## References

[1] *Polymers in aqueous solution* //Wiley-Blackwell. 2002

## Acknowledgements

The financial support of the reported study was provided by the Russian Science Foundation, project number 20-13-00038. Light scattering measurements were performed at the Centre for Diagnostics of Functional Materials for Medicine, Pharmacology and Nanoelectronics of the Research Park of St. Petersburg State University.



# RESEARCH ON OBTAINING A SYSTEM FOR TARGETED DELIVERY OF PROTEIN OBJECTS BASED ON CHITOSAN NANOPARTICLES WITH CHEMISORBED OBJECT APPLICATION

*Zagvozhkin M.D.<sup>1</sup>, Chernikova E.E.<sup>1</sup>, Brussevich A.<sup>2</sup>*

<sup>1</sup> Tomsk State University, Department of Chemistry, Tomsk, Russia

<sup>2</sup> ITMO University, Infochemistry Scientific Center, St. Petersburg, Russia

Student, Master's degree

[maximprimakv4@gmail.com](mailto:maximprimakv4@gmail.com)

Nanoparticles used in drug delivery systems are usually designed or selected based on their size and characteristics according to the pathophysiology of tumors [1].

One of the carriers of biological entities are polycations, where chitosan acts as one of the most commonly used ones. Polycations are high molecular weight compounds made of positively charged organic monomers. In solution, they spontaneously form complexes-nanoparticles with negatively charged nucleic acids - polyplexes. Polyplexes are able to enter the cell by endocytosis, where they destroy the lysosome membrane by shifting the pH inside the organoid. Despite the strong interaction of chitosan with biological molecules, in particular with RNA, modification of the polymer by hydroxyl group (C-3) and amino group (C-2) by hydrophobic molecules of fatty or bile acids increases the affinity of the polymer to the cell membrane and simultaneously weakens the interaction with RNA [2].

In the process of synthesis we used: low molecular weight chitosan ( $[C_{12}H_{22}O_8N_2]_n$ ),  $CaCl_2$ ,  $Na_2HPO_4 \cdot 12H_2O$ , bovine serum albumin (BSA) solution (MM = 69 kDa), NaOH, terephthalic aldehyde ( $C_8H_6O_2$ ), distilled water.

In the first stage, 10%  $Na_2HPO_4 \cdot 12H_2O$  solution and 0.5% low molecular weight chitosan solution in 0.5% aqueous acetic acid solution were prepared. and 0.5% solution of low molecular weight chitosan in 0.5% aqueous acetic acid solution. Then, the chitosan solution was slowly added through a separating funnel into the  $Na_2HPO_4 \cdot 12H_2O$  solution under constant stirring. After mixing, the prepared solution was brought to pH=10 with aqueous NaOH solution and stirred for 20 minutes on a magnetic stirrer. Terephthalic aldehyde was used for activation and rigid crosslinking of chitosan. An aqueous solution of terephthalic aldehyde with a concentration of 2.5 mg/mL was prepared under heating and constant stirring, then added to the alkalized chitosan solution. The resulting solution was stirred for 1 hour at 50°C. The last stage of synthesis was selection of the obtained chitosan particles and soaking in an aqueous solution of bovine serum albumin (BSA) at an albumin to water ratio of 1 to 1.

The surface morphology of the obtained materials was investigated on a HITACHI TM-3000 electron microscope at an accelerating voltage of 5 kV for all samples, in the low vacuum mode. The obtained images are presented in Scheme 1.

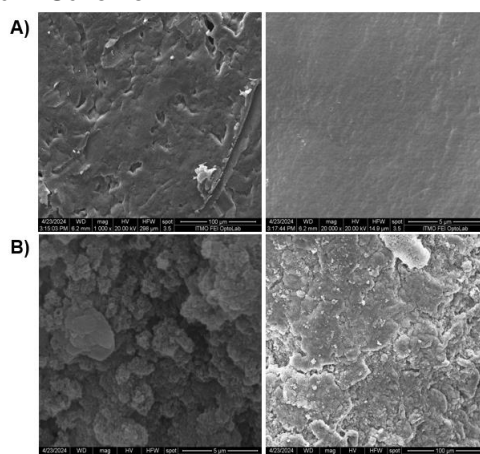

**Scheme 1.** SEM images of the obtained chitosan particles with chemisorbed BSA. A) *materials without HA deposited on the surface* B) *materials with HA deposited on the surface.*

In this research, chitosan particles with chemisorbed BSA, when deposited on HA surface and without it, were obtained. By comparing the SEM images, it can be seen that the surface shows a transition from a film-like surface structure to a polycrystalline one with a bimodal distribution of particle fractions in the range of 365 to 480 nm and 510 to 965 nm.

## References

- [1] *Artif. Cells Nanomed. Biotechnol.* 2018. 46. 295.
- [2] *Mol. Pharmaceutics.* 2015. 12. 301.

## ION-CONDUCTING POLYMERIC MATERIALS FOR ELECTROCHEMICAL STORAGE DEVICES.

*Zakharova D.V.<sup>1</sup>, Vizgalov V.A.<sup>1</sup>, Morozova S.M.<sup>1</sup>*

<sup>1</sup>Moscow Institute of Physics and Technology, National Research Institute, Institutsky Lane, d 9,  
Dolgoprudny, Russia  
[Zakharova.dv@mipt.ru](mailto:Zakharova.dv@mipt.ru)

Electrochemical energy sources include metal-ion batteries, fuel cells, and flow batteries. One of the key components is ion-conducting materials, which can serve as an ion-conducting membrane and binder in an electrode material.<sup>1,2</sup> The performance of the battery is largely determined by the properties of the ion conducting membrane. Therefore, the development of new conductive polymer electrolytes is an urgent problem and plays a crucial role in the development of high-performance batteries. At the same time, it is necessary to maintain a balance between high ionic conductivity, which is characterized by low glass transition temperatures of polymers, and high strength characteristics, which require a high glass transition temperature. The aim of this work was to obtain membranes based on a crosslinked ionic polymer, which, due to the ionic structure, would have high ionic conductivity, and due to dense crosslinking, good mechanical properties. The general scheme for producing conductive polymer membranes is shown above (**Scheme 1**).

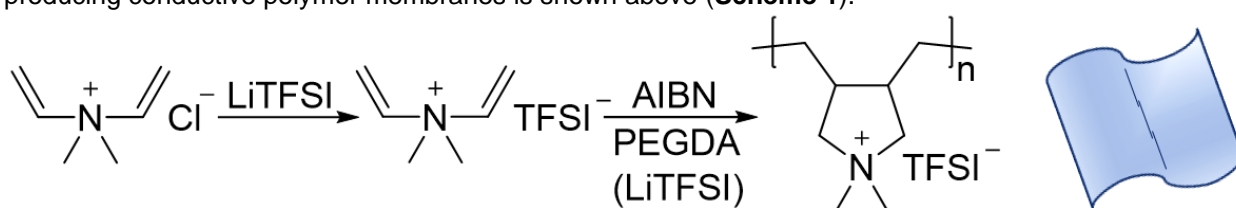

**Scheme 1.** General scheme of ionic conductive membranes synthesis.

The ionic monomer was synthesized by ion-exchange reaction with one of the most perspective counter ion for highly conductive membranes, namely, bis(trifluoromethanesulfonyl)imide (TFSI) (Scheme 1, left) and then was polymerized in the presence of poly(ethylene glycol) diacrylate as crosslinker and Li-salt (Scheme 1, right). The advantages of the proposed approach include the simplicity of obtaining ionic conductive membranes. The effect of the concentration of the crosslinking agent, lithium salt, temperature and polymerization time on the ionic conductivity of the obtained membranes was studied. The ionic conductivity of the obtained membranes was measured by testing in Li-ion batteries. It is shown that with an increase of the Li-salt content the value of the conductivity increases.

The temperature dependence of the ionic conductivity will be studied for the membrane with the highest lithium salt content.

### References

[1] *Chemical communications*, **2018**, 54(55), 7570-7588.

[2] *Journal of Membrane Science*, **2021**, 632, 119355.

### Acknowledgements

This work was supported by the Ministry of Science and Higher Education of the Russian Federation (Goszadaniye) 075-03-2023-106, project No FSMG-2022-0012.

Electrochemical impedance spectroscopy was carried out using potentiostats SP-200 and SP-300 in N.N. Semenov Federal Research Center for Chemical Physics Russian Academy of Sciences. The authors thank Savinov V.S., Gaianov R.I., Repina A.A. and Lagutkina A.A. for performing of conductivity measurements and discussions.

## RESEARCH OF AGING OF PLASTIC DETAILS FOR TPTS EQUIPMENT

*Zherdochkina Y.S.<sup>1</sup>, Ugolkova M.A.<sup>1</sup>, Belova O.A.<sup>1</sup>, Lazareva O.L.<sup>1</sup>, Popova E. I.<sup>1</sup>, Nevskiy R.E.<sup>1</sup>, Sokovishin A.V.<sup>1</sup>*

<sup>1</sup>FSUE «VNIIA», Moscow, Russia

Engineer

[zhyordochkina@yandex.ru](mailto:zhyordochkina@yandex.ru)

One of the leading areas of VNIIA activity is the production of software and hardware means (TPTS) and complexes for automation of energy facilities, including nuclear power plants [1]. This equipment has applications in the countries with different climatic conditions. Therefore, even materials that do not work in the reactor core shall meet high requirements as for long aging stability. Automated control systems developed by VNIIA form software and hardware complexes built based on TPTS equipment. Electronic modules are assembled into instrumentation cabinets with mounting connections between them. To protect cables coming out of the cabinets, bushings made of polymer materials are applied to the outlet holes in the metal.

The main task of this paper is choosing an optimal material for manufacturing plastic bushings for TPTS equipment. The constructors suggested one of the two materials, being processed by pressure casting method: urethane elastomer and PVC (polyvinylchloride) soft insulating material. In the course of the research of the polymer materials aging it was determined that the urethane elastomers are prone to hydrolysis of ester groups [2]. Primary aging mechanism of PVC material is dehydrochlorination (unventilated condition) and a plasticizer desorption (ventilated condition) [3]. Based on the research results as an optimal material for TPTS equipment, being used in humid climate countries, was recommended PVC soft insulating material.

### References

- [1] Marinicheva O.F. *Energy and Industry in Russia*. **2010**, 18, 12.
- [2] Brown D.W., Lowry R.E., Smith L.E. *Macromolecules*. **1980**, 13, 248.
- [3] Ivanov V.B., Popova E. I., Solina E.V. *Macromolecular Compounds*, **2017**, ser. B, vol. 59, no. 3, 234–240.

### Acknowledgements

The authors express the gratitude to the colleagues Evgeniy Olgerdovich Skirgello and Lyudmila Efimovna Doroguinina for valuable consultations.



# **ABSENTEE PARTICIPANTS**

## SOFT DOSAGE FORMS BASED ON PECTIN

*Afanas'eva M.A., Lazdin R. Yu.<sup>1</sup>, Shurshina A.S.<sup>1</sup>*

<sup>1</sup> Ufa University of Science and Technology, Ufa, Russia  
Postgraduate student  
[shurshinaas@uust.ru](mailto:shurshinaas@uust.ru)

Polymeric drug delivery systems play a critical role in optimizing the therapeutic efficacy of drugs by overcoming the limitations of traditional dosage forms. These limitations include low bioavailability, poor solubility, and short half-life, which can significantly affect drug efficacy and necessitate frequent dosing. However, controlled drug delivery systems such as polymer-based gels offer a promising solution by providing sustained drug release over a long period of time. This sustained release property helps maintain therapeutic drug concentrations within the desired range, avoiding sudden increases or decreases that can lead to suboptimal treatment results. Various polymers, both synthetic and natural, are used as gel components. Among natural polymers, the physiologically active polymer pectin is of interest.

The formation of pectin-based gels occurs when a concentration equal to  $C_{gel}$  is reached. The  $C_{gel}$  concentration can be easily determined by the nature of the dependence of the storage and loss modulus on frequency from rheological data. In the region of semi-dilute solutions at concentrations  $C \approx C_e$ , the values of the loss modulus exceed the values of the storage modulus in the region of low oscillation frequencies. This allows us to speak of pectin solutions as fluid liquids with weak elastic properties. As the polymer solution is concentrated, the nature of the dependence of the storage and loss modulus changes frequently. The loss modulus becomes larger throughout the entire frequency range studied Starting from a concentration of 12 g/dL.

Despite the fact that at the concentration of  $C_{gel}$  polymer liquids do not flow; however, the formed gels have low yield stress values, which does not allow their use as the basis for soft dosage forms. The addition of a gelling agent, which is calcium ions, leads not only to an increase in viscosity, but also to the formation of systems with a yield stress even in the concentration range in which they were not formed in the absence of calcium ions.

It is known that when polyanion molecules come into contact with divalent cations (eg  $Ca^{2+}$ ), the ionic interaction between the negatively charged macromolecules and the positively charged divalent calcium ions results in intermolecular cross-linking (known as "eggbox"). This process is known as the ionotropic gelation method. It is important that with this crosslinking method, compression of macromolecular coils and intensification of intramolecular aggregation processes does not occur, which occurs if the gel is formed only by increasing the concentration of the polymer in the solution. Consequently, the decrease in the availability of polymer units for interaction with the drug substance, which occurs with increasing concentration of the polymer in solution [1, 2], does not occur in this case, which means that the effect of prolonging the release of the drug substance can be expected.

Analysis of the release curves of cefazolin from soft dosage forms showed that in the presence of calcium ions, the release of cefazolin from pectin solutions occurs significantly more slowly than in their absence. Increasing the concentration of pectin to 12 g/dl, in the presence of calcium sulfate, taken at a ratio of 100 mg per gram of polymer, makes it possible to obtain non-flowing, water-insoluble gels with a pronounced prolonging effect.

Thus, the study established that the effect of prolonging the release of the medicinal substance cefazolin from soft dosage forms based on pectin can occur when using additives capable of ionotropic gelation.

### References

- [1] *Polymer Science, Series B* **2023**, 65, 41
- [2] *Chimica Techno Acta* **2022**, 9, 20229206

## SYNTHESIS AND INVESTIGATION OF CROSS-LINKED HYALURONIC ACID NANOPARTICLES FOR BIOACTIVE SUBSTANCES DELIVERY

*Budushina E.M., Kostandyan E.S., Timofeeva A.M., Sulpovar M.L., Dyatlov V.A.*

D. Mendeleev University of Chemical Technology of Russia, Moscow, Russia  
Student

[budushina.elizaveta@gmail.com](mailto:budushina.elizaveta@gmail.com)

Nowadays nanoscale systems for targeted drug delivery are of growing interest. Nanoparticles allow increasing efficacy of drug. This is high-priority essential to enzymes and drugs that characterized low chemical stability in biological media and difficult to dosage. In addition, nanoparticles can provide patient-specific medical therapy. Encapsulation of drugs inside nanoparticles or nanocapsuls allows to increase their bioavailability and biodistribution, and promotes improved penetration of the biologically active substance into the target cell [1].

Currently known and are used variety types of different organic and inorganic origin nanoparticles. Great importance is also attached to polymeric nanoparticles (PNPs) as far as they exhibit easily variable properties [2]. PNPs have unique properties and are widely used in biomedicine as transport systems. The most relevant is the use of natural polysaccharides as a basis for the creation of nanoscale drug delivery systems. They are non-toxic, biodegradable, hydrophilic and safe. And due to the presence of a large number of functional groups throughout the macromolecular chain, polysaccharides can be easily modified to produce various derivatives.

Hyaluronic acid is one of the most important polysaccharide composing the extracellular matrix of living beings. It is known far and wide, that hyaluronic acid is an essential component that provides such important functions of the body as regulation of cell differentiation and migration and wound healing [3]. It has been used in medicine, cosmetics, food and other biomedical applications. Despite of many advantages of hyaluronic acid such as non-toxicity, biodegradability, cytocompatibility it has several drawbacks that limiting widespread application in biotechnology. These disadvantages include low stability in biological environments and absence of reactive groups that can easily interact with various bioactive compounds [4]. We can overcome all of these limitations and find more versatile application of hyaluronic acid using modification. It should be mentioned that introduction of crosslinking agent is one of the most promising technique to pristine hyaluronic acid modification [5].

In the present study, a new method for cross-linked with 1,4-butanediol diglycidyl ether hyaluronic acid gel nanoparticles synthesis in a two-phase polymer system has been proposed. We used 1,4-butanediol diglycidyl ether (BDDE) as the crosslinking agent of hyaluronic acid. The particles were prepared in a biphasic system formed by aqueous solutions of two immiscible polymers in a cooled reactor with continuous ultrasonic treatment. Polyvinylpyrrolidone aqueous solution was used as a dispersed medium. The chemical structure of the products was determined by <sup>13</sup>C nuclear magnetic resonance spectroscopy and MALDI-ToF mass- spectrometry. The particle size and distribution were investigated via dynamic light scattering. According to the results obtained after MALDI-ToF-MS It can be concluded that the particles require pretreatment purification stage. This stage is aimed removing excess of polyvinylpyrrolidone. A series of peaks with the mass-to-charge ratio period  $m/z=111$  were observed on MALDI-ToF mass-spectrum. This corresponds to molecular ions formed during the sequential elimination of constituent repeating units with a mass of 111 from polyvinylpyrrolidone. A signal with a mass-to-charge ratio of  $m/z = 1920.86$  probably corresponds to two disaccharide fragments of hyaluronic acid interconnected by intermolecular cross-linking. The synthesized particles size ranged from 100 to 200 nm.

In conclusion it may be summarized, that cross-linked with BDDE hyaluronic acid nanoparticles can be formed in two immiscible polymer-polymer media. Synthesized nanosized particles based on cross-linked hyaluronic acid can be consider as a promising candidate for modern biological active substances carrier development.

### References

- [1] *Adv. Drug Deliv. Rev.* **2008**, 60, 1650
- [2] *Coll. Polym. Sci.* **2009**, 287, 991
- [3] *Mater. Sci. Engin.* **2017**, 80, 771
- [4] *Sci. Innov.* **2017**, 4, 16
- [5] *Acta. Biomed. Scientif.* **2023**, 8, 23

PET-RAFT POLYMERIZATION OF METHYL METHACRYLATE IN THE PRESENCE OF POLYMER MODIFIED TITANIUM DIOXIDE

*Chicharov A.A., Krasnova V.V., Vlasova A.O., Zaitsev S.D.*

Lobachevsky University, Nizhny Novgorod, Russia

Student

[aleksandr.tchicharov@yandex.ru](mailto:aleksandr.tchicharov@yandex.ru)

Polymerization reactions initiated by UV-Vis light has gained increasing interest as an approach which works on a wide range of monomers with good control. Combining reversible addition–fragmentation chain transfer (RAFT) polymerization and photoinduced electron / energy transfer process, polymers with desired properties can be obtained. However, selecting a catalyst and increasing its efficiency is still an actual problem in macromolecular chemistry.

Titanium dioxide is a cheap and renewable catalyst. Its efficiency depends on the particle size, so modification of its surface with polymer matrix is of interest. We chose a cross-linked copolymer of hydroxyethyl methacrylate and acrylonitrile, that allows to synthesize N-doped titanium dioxide [1]. The molar ratio of titanium to hydroxyethyl methacrylate and acrylonitrile is 1:5:1. Band gap of TiO<sub>2</sub> in copolymer is 3.00 eV, its particle size is 8 nm, percentage of anatase is 100%. Cyano-4-(((dodecylthio)carbonothioyl)thio)pentanoic acid (CDTPA) was chosen as the reversible chain transfer agent. It is relatively resistant to UV radiation, which allows for process control over time.

Polymerization was carried out in quartz glass ampoules under an inert atmosphere. CDTPA (0.01 M) and a catalyst at the rate of 1 mg of titanium dioxide/ml were added to a mixture of methyl methacrylate and dimethylformamide in a volume ratio of 3:1. The mixture was irradiated with stirring for a certain time with a UV lamp (300W OSRAM ULTRA-VITALUX) at a distance of 30 cm. The conversion was determined gravimetrically. Molecular mass characteristics were determined by gel permeation chromatography.

The conversion dependence has a linear form in semi-logarithmic coordinates, indicating a controlled process mode A faster polymerization process is observed, when TiO<sub>2</sub> surface is modified with polymer (Scheme 1):

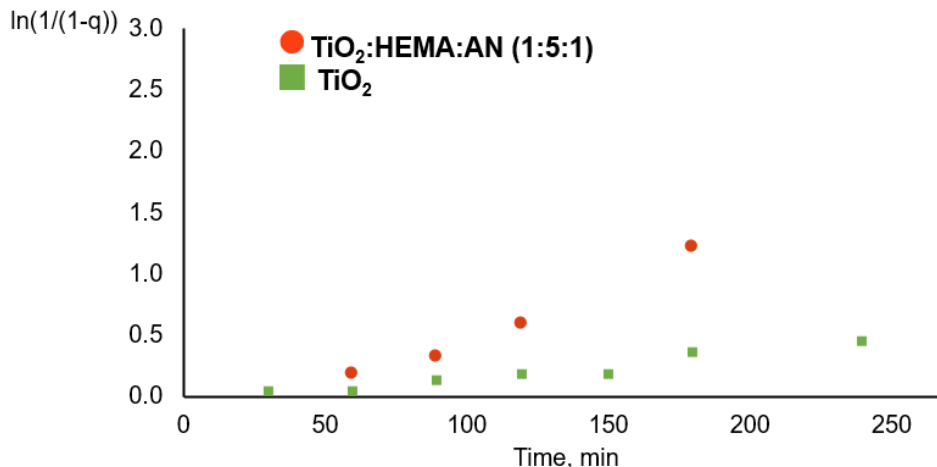

**Scheme 1.** Semi-logarithmic conversion dependence of methyl methacrylate polymerization in the presence of unmodified and polymer modified titanium dioxide.

Control over the process is maintained, as evidenced by the low PDI. The increase in polymerization rate is explained by the presence of nitrogen atoms, which presumably facilitate electron transfer.

## References

[1] *Photochem.* **2021**, 1, 371.

## RESEARCH OF THE POSSIBILITY OF CREATING A COMPOSITE MATERIAL BASED ON ULTRA-HIGH MOLECULAR POLYETHYLENE MODIFIED WITH MALEIC ANHYDRIDE

*Khramova S.A.<sup>1</sup>, Kladovshchikova O.I.<sup>1</sup>, Tikhonov N.N.<sup>1</sup>, Stepanova T.S.<sup>1</sup>, Komarova E.A.<sup>1</sup>*

D. Mendeleev University of Chemical Technology of Russia, Moscow, Russia

Student

[shramova18@gmail.com](mailto:shramova18@gmail.com)

Ultra-high molecular weight polyethylene (UHMWPE) is one of the most promising structural materials. This material has a unique set of physical, mechanical, technical and operational properties; it is widely used due to its high wear resistance and stability in aggressive environments, low coefficient of friction, high specific viscosity at record temperatures (up to – 200°C). A significant disadvantage is the difficulty of processing UHMWPE [1].

To improve the processability of ultra-high molecular weight polyethylene, which has a MFI of less than 0.1 g/10 min, the method of mixing it with a low molecular weight and high-flow copolymer of ethylene with propylene brand ExxonMobil Vistamaxx 6202, which has a melt flow rate of 20 g/10 min, was selected using the screw extrusion method, which made it possible to process the material using a high-performance extrusion method [2].

This work examines the UHMWPE-Vistamaxx 6202 composition, into which high-density polyethylene modified with maleic anhydride Bondyram® 5101P (Polyram Plastic Industries LTD), hereinafter referred to as P/MA, was introduced, containing functional groups that increase its adhesion to various polymers, fillers and metals. Bondyram® 5101P is used as a coupling agent to improve the mechanical properties of polyethylene filled compounds, which can provide greater interaction between components of the mixture having different melt flow rates.

The materials were produced using a twin-screw extruder at a temperature of 220°C. To assess the structural changes that occur in materials during their mixing, as well as during modification, the method of differential scanning calorimetry was used, the areas of crystallization peaks ( $\Delta H_c$ , J/g), melting peaks ( $\Delta H_{mel}$ , J/g), and temperatures were determined peaks  $T_c$  and  $T_{mel}$ , based on the data obtained, the degree of crystallinity was calculated [3]. As a result of combining UHMWPE with an amorphous ethylene-propylene copolymer, a decrease in the degree of crystallinity, as well as melting and crystallization temperatures, is observed.

The assessment of rheological properties was carried out by measuring the melt flow index (MFI) at a temperature of 220°C and a load weight of 7.6 kg. When P/MA is introduced into the UHMWPE-Vistamaxx 6202 composition, the MFI decreases.

The deformation-strength characteristics were determined during tensile tests, an improvement in elongation and tensile strength was observed [4].

The introduction of polyethylene modified with maleic anhydride into the resulting composition leads to a decrease in the degree of crystallinity compared to the unmodified material, apparently due to the fact that as a result of partial grafting of materials with the introduction of reactive maleic anhydride, the crystallizing sections of macromolecules are located between the nodes of the resulting network. The formation of cross-links increases the viscosity of the system, reducing the mobility of macromolecules, which is confirmed by the results obtained when determining the MFI of materials.

#### References

- [1] *Chemistry for sustainable development*, **2010**, 375-388, 420
- [2] *Chemical physics*, **2020**, 66-71, 92
- [3] Kurtz, S.M. *The UHMWPE Handbook Ultra-High Molecular Weight Polyethylene in Total Joint Replacement*, **2004**, 15-20, 379
- [4] Lutovinova T. A., Zavrazhin D. O. *Study of the physical and mechanical properties of modified UHMWPE // Collection of scientific materials of the All-Russian School-Seminar with International Participation on Structural Macrokineics for Young Scientists named after Academician A.G. Merzhanova*, **2018**, 78-80



## PECULIARITIES OF RUBBER BLEND FORMULATIONS FOR REINFORCED HOSES MANUFACTURING

*Panfilova O.A., Volfson S.I., Muhamethanov I.I., Nazipov I.I., Rudnitsky I.V.*

FSBEI HE "Kazan National Research Technological University"

Associate professor, PhD

[ilyarudzz04@gmail.com](mailto:ilyarudzz04@gmail.com)

Hoses, or flexible pipelines, are designed to transport various media. These are multilayer rubber-fabric and/or rubber-metal products, which are exposed to various factors depending on the operating conditions. First of all, the type of transporting media (gases, liquids of various chemical composition), transportation conditions (pressure, temperature) as well as external atmospheric factors has great influence.

The purpose of this work was to develop a formulation of a rubber compound for the manufacture of the inner layer of high-pressure hoses of a braid and winding structure according to the requirements

Properties of rubber compounds

Requirements: Max. torque = 17 - 22 MH, dN\*m; Min. torque = 2,9 - 3,9 ML, dN\*m; Scorch period,  $T_{10}$ , = 0,45 – 1,0 min; Optimum curing time,  $T_{90}$ , = 2,2 – 2,5 min; Mooney viscosity 90 – 100 °C; Scorch time,  $T_5$ , > 30 min. Developed composition: Max. torque = 25,0 MH, dN\*m; Min. torque = 3,0 ML, dN\*m; Scorch period,  $T_{10}$ , = 0,68 min; Optimum curing time,  $T_{90}$ , = 2,2 min; Mooney viscosity 110 °C; Scorch time,  $T_5$ , > 35 min.

Properties of vulcanizates

Requirements: Tensile strength > 14 MPa; Elongation at a break > 160 %; Hardness 78-88 Shore A; Density ≤ 1,49 g/cm<sup>3</sup>; Oil < 60; Water < 25; Aqueous liquids < 25; Adhesion to wire > 60 H.

Developed composition: Tensile strength = 16,4 MPa; Elongation at a break = 185 %; Hardness = 79 Shore A; Density = 1,28 g/cm<sup>3</sup>; Oil = 9,9; Water = 6,2; Aqueous liquids = 4,4; Adhesion to wire = 104 H

The inner layer of hoses of the braided structure is in direct contact with the cavity of the reinforcing layer, which gives the products higher strength. In this case, a 0.30 – RML-3 steel latuned wire with a diameter of 0.3 mm was used. The arrangement of wire directly on the inner layer of the hoses determines the high value of the Mooney viscosity (90-110 units) as an important technological indicator of the composition being developed, since the use of less viscous rubber compounds can lead to «crumpling» of the raw layer or its cutting with wire.

At this work the simultaneous influence of a number of factors on the properties of rubber compounds and vulcanizates was evaluated. So, different grades of nitrile butadiene rubbers with different content of acrylonitrile and Mooney viscosity, the possibility of their partial replacement with non-polar general purpose rubbers was studied; the type and content of fillers were varied as well as the composition of the curing system; special purpose additives were investigated to increase the adhesion to the latuned wire.

It was found that required oil resistance could be achieved by using nitrile butadiene rubbers with an average content of acrylonitrile. High viscosity could be result of usage of a combination of carbon black and silica fillers, which are simultaneously capable of influencing the interaction at the rubber–latuned steel interface. The use of mineral fillers, even in small dosages, is undesirable, despite the slight effect on stress-strain properties, improvement of economic indicators of compositions and increasing of rubber compounds viscosity because its reduce the resistance of compositions to the effects of aqueous liquids sharply. An increase in the dosage of sulfur, which increases the adhesive strength of the rubber-latuned steel compound, reduces the scorch time and the optimal curing time, taking them out of the required range, and also reduces the resistance of rubber compounds to scorch. To achieve a balance of these indicators, a curing system composition was optimized. Also, it should be noted that the introduction of adhesion promoters, for example, cobalt salts, slows the curing rate.

As a result, a formulation of rubber compound for inner layer of high-pressure braided and wound hoses was developed.

## AMPHOTROPIC PROPERTIES OF 4-HYDROXYBENZOIC ACID POLYESTER

*Shornikov E. V.*<sup>1</sup>, *Grishin S. V.*<sup>1,2</sup>, *Karimova L. K.*<sup>1</sup>

<sup>1</sup> Kazan national research technological university, Kazan, Russia

<sup>2</sup> Kazan national research technical university, Kazan Russia

PhD student

[egru116@ya.ru](mailto:egru116@ya.ru)

Of particular interest recently has been the creation of materials with an improved set of properties for use in high-tech industries. Heat-resistant rigid-chain liquid crystal polyesters occupy a special place in this field. Of greatest interest is the improvement of the chemical structure of rigid-chain polyester by introducing fragments of dicarboxylic acids, naphthols, diatomic phenols, bifunctional derivatives into the structural unit and their effective combination. [1-2].

At the same time, there is a significant question about revising the method of synthesizing polyesters using alternative monomers, since current production methods have a number of disadvantages: the use of expensive precursors for the synthesis of monomers and the impossibility of reusing the step wise polymerisation by-product.

The synthesis of polyester 4-HBA includes two stages: in the first stage, the phenyl ester 4-HBA is formed with a slight excess of phenol. Then transesterification of the phenyl ether 4-HBA occurs with the elimination of phenol and the formation of poly(p-hydroxybenzoyl). [1-2]

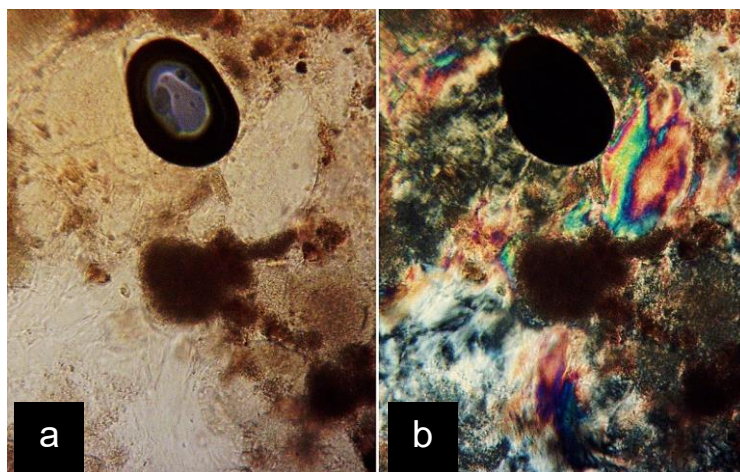

**Scheme 1.** Micrograph of a solution of polyester in DMAA in unpolarized (a) and polarized light (b), 70°C, 500x magnification

It is known from literature data that polyester undergoes a phase transition at a temperature of 350 °C, associated with a reversible transition to the liquid crystalline state. Due to the high transition temperature of polyester based on 4-HBA into an isotropic melt, the study of its phase transitions when heated with polarized optical microscopy is difficult. However, the sample exhibited lyotropic properties when heated in dimethylacetamide (DMMA) starting at 55°C. The solvent concentration was 30%.

When the sample was dissolved in DMAA, three phases were visible: the crystalline undissolved part of the sample, the solvent, and the swollen regions of the polyester. With further heating to 55°C, the swollen part of the sample in the solvent became transparent, but had clearly defined boundaries with the solvent. In unpolarized light, this portion of the polyester appeared transparent. Scheme 1 shows that the dissolved part of the polyether exhibits optical activity in polarized light.

#### References

- [1] *Bulletin of the Technological University.* **2021**, 5, 26  
 [2] *All materials. Encyclopedic reference book.* **2019**, 2

RESEARCH OF THE INFLUENCE OF RADIATION EXPOSURE ON POLYMER-POLYMER  
COMPOSITIONS BASED ON ULTRA-HIGH MOLECULAR POLYETHYLENE

Stepanova T.S.<sup>1</sup>, Kladvshchikova O.I.<sup>1</sup>, Tikhonov N.N.<sup>1</sup>, Khramova S.A.<sup>1</sup>, Komarova E.A.<sup>1</sup>

D. Mendeleev University of Chemical Technology of Russia, Moscow, Russia

Student

[toma.stepanova.01@inbox.ru](mailto:toma.stepanova.01@inbox.ru)

Ultra-high molecular weight polyethylene (UHMWPE) has a unique set of physical, mechanical and operational properties; it is characterized by high strength and impact characteristics, chemical inertness, high frost resistance, low coefficient of friction and high wear resistance [1] etc. It is considered one of the most promising among HDPE brands. However, its low processability and characteristic absence of a viscous-flow state do not allow UHMWPE to be processed by methods usually used for thermoplastics and to widely use this material in those areas where its use is most promising. Therefore, an important task is to increase the technological properties of UHMWPE while maintaining the original properties as much as possible.

In this work, we studied the features of combining ultra-high molecular weight polyethylene GUR 4120 (Celanese, Germany) with low-density polyethylene Snolen EP 0.26/51 with subsequent radiation exposure in order to obtain a technological material with a high complex of physical, mechanical and operational properties [2-3].

The components of the mixture were pre-mixed in a mixer and processed on a twin-screw laboratory extruder at a temperature of 220°C. Next, the materials were granulated and pressed, and then samples of the desired shape were cut out. To carry out radiation cross-linking, an ILU-8 pulsed linear electron accelerator was used, which uses the principle of linear acceleration. The radiation dose was  $2.09 \cdot 10^9$  eV/kg [4].

The samples were tested for tensile strength and elongation at break using a Tinius Olsen 50ST tensile testing machine. The structure of the obtained materials was studied by differential scanning calorimetry using a DSC 204 F1 Phoenix instrument (NETZSCH, Germany). The degree of cross-linking of polymer composites after irradiation was also assessed by the content of the gel fraction using a Soxhlet apparatus in xylene.

When analyzing the data obtained using the DSC method, it can be concluded that the formation of a three-dimensional spatial structure during cross-linking does not have a noticeable effect on the structural characteristics of the material. As a result of combining UHMWPE with HDPE and subsequent irradiation with a flow of fast electrons, an increase in the strength and elongation at break of a composite based on UHMWPE-HDPE is observed; also, radiation exposure has a positive effect on the degree of cross-linking of the compositions under study, and, accordingly, on the shore hardness of the samples compared to non-irradiated compositions.

#### References

- [1] *Chemistry for sustainable development*, **2010**, 375-388, 420
- [2] *Ushakova T. M. Polymer-polymer compositions based on ultra-high molecular weight polyethylene and high-density polyethylene: synthesis, morphology, properties // Chemical Physics*, **2020**, 66-71, 92
- [3] *Qizheng Dou, Alexandra Romina ALBUNIA, Yi Liu; Assignee BOREALIS, Pat. WO2015121161 A1*, **2015**
- [4] *Paul D.R. and Bucknell K.B. edited by Polymer mixtures. Volume II: Functional properties / D.R. Floor. - St. Petersburg: Scientific foundations and technologies*, **2009**, 606

## STUDYING THE EFFECT OF THE NATURE OF THE SOLVENT ACID ON THE PROPERTIES OF CHITOSAN FILMS MODIFIED WITH TITANIUM DIOXIDE NANOPARTICLES

*Sundareva Yu.A.<sup>1</sup>, Salomatina E.V.<sup>1</sup>, Smirnova O.N.<sup>1</sup>, Zarubin D.M.<sup>1</sup>, Smirnova L.A.<sup>1</sup>*

<sup>1</sup>Lobachevsky University, N. Novgorod, Russia

Student

[sundareva2002@mail.ru](mailto:sundareva2002@mail.ru)

Environmental pollution by plastic is one of the most discussed environmental problems of the modern world. In this regard, the actual problem is the search and substantiation of optimal basic raw materials for the production of new types of universal biodegradable food packaging. The most promising in this respect raw material component for matrix formation is chitosan (CS) due to its high film-forming ability. However, films based on chitosan have low strength and strain at break compared to synthetic polymers. This problem can be solved by introducing a functional additive - photoactive TiO<sub>2</sub> nanoparticles, which has biocompatibility and good physical and chemical properties. An important aspect in the creation of materials containing TiO<sub>2</sub> particles is the size of oxide particles and the uniformity of their distribution in the matrix.

In this work, CS films modified with TiO<sub>2</sub> nanoparticles (NPs) of different sizes were obtained from polysaccharide solutions in aqueous solutions of various acid-solvents. Acetic, hydrochloric, and lactic acids were used as the latter. TiO<sub>2</sub> NPs were synthesized by alkoxy sol-gel technology from titanium (IV) isopropoxide in isopropyl alcohol medium in the presence of water and HCl as catalysts. TiO<sub>2</sub> dispersions were added to chitosan solutions at concentrations from 0.5 to 10 wt.% relative to CS mass, after which films were obtained. The non-monotonic dependence of the films strength on the TiO<sub>2</sub> content in them was revealed. Optimal physical and mechanical properties, when high strength and deformation of samples are combined, are possessed by films with TiO<sub>2</sub> content not more than 2 wt.%. The observed effects are due to the change in the structure of the films when small concentrations of TiO<sub>2</sub> are introduced. The increase in the amount of TiO<sub>2</sub> leads to a violation of continuity, and, as a consequence, a decrease in strength characteristics, which is proved by methods of infrared spectroscopy, X-ray phase analysis, scanning electron and atomic force microscopy. At the same time, the film strength increases depending on the nature of the solvent acid in the series lactic acid > hydrochloric acid > acetic acid (Scheme 1). All samples contain less moisture after prolonged storage compared to pure chitosan film. The bactericidal properties of the films against *Staphylococcus aureus* were revealed. The materials are biodegradable and decompose by 50% in 28 days under the action of the fungus *Aspergillus Niger*.

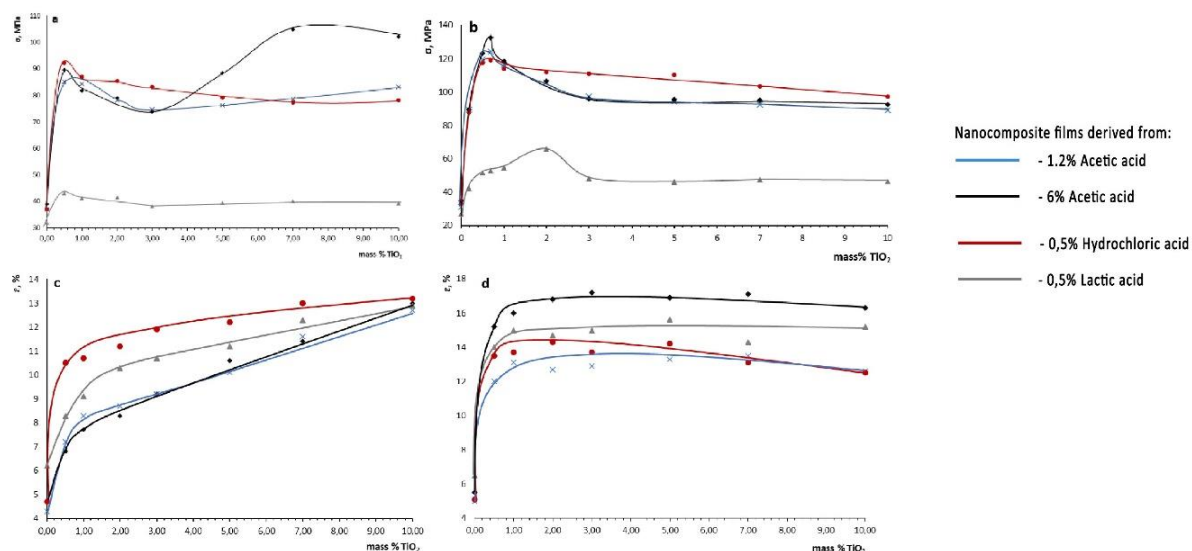

**Scheme 1.** Mechanical properties of chitosan films in salt (a, c) and based (b, d) forms modified with different mass. % of titanium dioxide obtained from different acid solvents.

Thus, further research and development in this area may lead to commercialization of chitosan-TiO<sub>2</sub> nanocomposites for their application as food packaging material.

### Acknowledgements

This work was financially supported by RCF (No. 23-74-100-69)

MICROENCAPSULATION OF WHEAT SEEDS WITH GELLAN AND NEW  $\alpha$ -AMINOPHOSPHONATE

*Tursynova B.G.<sup>1,2</sup>, Dyussebayev B. Y.<sup>1,3</sup>, Ten A. Yu.<sup>1</sup>*

<sup>1</sup>A.B. Bekturov Institute of Chemical Sciences", Almaty, Kazakhstan

<sup>2</sup>al-Farabi Kazakh National University, Almaty, Kazakhstan

<sup>3</sup>Abai Kazakh National Pedagogical University, Almaty, Kazakhstan

Master student

[tursynova\\_0101@mail.ru](mailto:tursynova_0101@mail.ru)

Currently, microencapsulation of seeds is attracting more and more attention from agriculture, as this technology increases yields, protects against stress and diseases, helps to adapt to changing conditions and improves resource efficiency [1].

This work is devoted to the microencapsulation of wheat seeds with the natural polymer gellan with the addition of a new synthesized biologically active substance -  $\alpha$ -aminophosphonate based on pyrimidinylpiperazine (Kaz-20).

To obtain  $\alpha$ -aminophosphonate, a convenient method of the three-component Kabachnik-Fields reaction is used, which is carried out by boiling in benzene using a Dean-Stark trap to remove the resulting water. The target product is purified by column chromatography on  $Al_2O_3$ , eluting with a system chloroform:hexane (in a ratio of 1:1).

Since a water-soluble form of the test substance is required for further biological screening, its  $\beta$ -cyclodextrin complex (Kaz-20+ $\beta$ -CD) was obtained, which showed good growth-stimulating as well as myelostimulating activity [2].

In order to prolong the action of BAS and obtain its controlled release, the immobilization of  $\alpha$ -aminophosphonate based on pyrimidinylpiperazine (Kaz-20) on a natural polymer gellan was carried out. Gellan is a biodegradable, affordable polymer, and also has rheologically stable properties, which makes it suitable for use in various fields, including food, pharmaceutical, cosmetic and other industries [3]. To prepare the encapsulation solution, an aqueous gellan solution mixed with Kaz-20 (1:0.01 wt.%) was formed by combining at a temperature of 30°C to achieve a homogeneous mixture.

Microencapsulation of wheat seeds Kaz-20 immobilized on gellan was carried out in the following way: the grain is immersed in a thick solution of "gellan+Kaz-20", then the grain covered with a layer of hydrogel immersed in a precipitation bath with a solution of 3M KCl, in which the wet deposition process takes place. At the moment of contact with the KCl solution, the grain surface is covered with gellan in the form of a thin shell. By germinating microcapsulated seeds, the optimal number of layers for germination was determined, which was 2 layers (dry shell thickness ~ 0.4 mm).

The immobilization of Kaz-20 on gellan was carried out in two ways: the first - was dissolved gellan and Kaz-20 was added (gellan+Kaz-20), the second Kaz-20 was first dissolved, and then gellan was added (Kaz-20+gellan). When germinating seeds encapsulated by both methods, the best result was shown by the first order of immobilization - gellan+Kaz-20.

According to the results of this work, a new  $\alpha$ -aminophosphonate based on pyrimidinylpiperazine was synthesized, its water-soluble  $\beta$ -cyclodextrin complex was obtained, which showed high biological activity. To prolong the action of  $\alpha$ -aminophosphonate based on pyrimidinylpiperazine, its microcapsules based on natural polymer gellan (gellan+Kaz-20) were obtained. As a result of the study of microcapsules for the growth of stimulating activity for wheat seeds, gellan+Kaz-20 showed a better result than the control (water).

### References

- [1] *Reviews in Chemical Engineering* **2021**,5,603-616  
 [2] Application for Patent for invention of the Republic of Kazakhstan No. 2023/0319.1 dated 05/11/2023  
 [3] *Biopolymers for Food Design* **2018**, 20,191-222

### Acknowledgements

This research was funded by the Science Committee of the Ministry of Science and Higher Education of the Republic of Kazakhstan (grant number AP19675500)

## EFFECT OF MECHANICALLY ACTIVATED CARBON FIBERS WITH ZIRCONIUM OXIDE ON THE PROPERTIES OF POLYTETRAFLUOROETHYLENE

*Vasilev A.P., Lazareva N.N., Okhlopkova A.A., Struchkova T.S.*

North-Eastern Federal University, Yakutsk, Russia

[gtvap@mail.ru](mailto:gtvap@mail.ru)

One of the current challenges in modern materials science is the development of polymer composite materials (PCM) for use in the cold climates of the North and the Arctic. The components most susceptible to failure in these climates are those in friction units. Consequently, increasing the durability and reliability of machines and mechanisms is a priority in both the scientific and economic sectors of the country. Extending their service life results in significant savings of material and financial resources. Among polymers, polytetrafluoroethylene (PTFE) is particularly relevant due to its chemical inertness, heat resistance, low friction coefficient, and wide range of operating temperatures, making it a versatile material for various applications [1]. However, it is extremely low wear resistance and poor creep resistance limit its use in friction units [2]. Therefore, the task of improving the mechanical properties and wear resistance of PTFE, especially under conditions of severe friction, remains a pertinent issue.

The aim of this work is to study the influence of carbon fibers (CF) with zirconium dioxide ( $ZrO_2$ ) on the properties of PTFE.

In this study, the mechanical and tribological properties of PTFE and PCM were investigated using standard methods [3]. It was shown that the introduction of CF into PTFE from 5 to 10 wt.% leads to a 57% increase in compressive stress compared to the original polymer. The strengthening of the polymer matrix upon the introduction of CF is connected with the reinforcing effect due to stress transfer from the matrix to the fibers. The Shore D hardness of the composites increased from 5 to 10 wt% by 20%, with a further increase of 12% compared to the original PTFE. Differential scanning calorimetry, scanning electron microscopy, and X-ray diffraction analysis were conducted to explain this change in properties. Thus, the introduction of complex fillers into PTFE leads to the improvement of compressive strength properties and hardness of the polymer matrix, which is important for tribological materials.

The results of tribological tests showed a significant improvement of PTFE wear resistance at introduction of complex fillers in all PCM. At introduction of 5 wt.% CF+1 wt.%  $ZrO_2$  in PTFE leads to decrease of specific wear rate by 860 times, at content of 10 wt.% by 580 times in comparison with polymer matrix. Further increase of fiber filler content up to 15 wt.% increases wear resistance 370 times relative to polymer matrix and 2.3 times lower in comparison with PTFE+5%CF+1% $ZrO_2$ . In all cases, the friction coefficient of PCM increases relative to the polymer matrix. At the content of 5-10 wt.% CF in PTFE the value of friction coefficient increased by 45%, and at the content of 15 wt.% CF by 63% in comparison with the initial polymer. Thus, the best results on wear resistance and friction coefficient were obtained in PCM of composition PTFE+5%CF+1% $ZrO_2$  and PTFE+10%CF+1% $ZrO_2$ . The introduction of complex fillers in PTFE has a positive effect on the operational properties. The developed materials due to high wear resistance can be used in friction units of machines and equipment.

### References

- [1] *Polymer-Plastics Technology and Materials* **2022**, 61 (18), 1973–1987
- [2] *Chin J Polym Sci* **2013**, 31 (3), 377–387
- [3] *Polymers* **2023**, 15 (2), 313

### Acknowledgements

This work was supported by the Ministry of Science and Higher Education of the Russian Federation (project No FSRG-2023-0026).

## SYNTHESIS AND INVESTIGATION OF PH-SWITCHABLE RAFT AGENTS IN POLYMERIZATION OF VINYL MONOMERS

Vlasov A.M.<sup>1</sup>, Vlasova A.O.<sup>1</sup>, Zaitsev S.D.<sup>1</sup><sup>1</sup>Lobachevsky State University of Nizhny Novgorod, Nizhny Novgorod, Russia  
Student[artem.vlasov5702@gmail.com](mailto:artem.vlasov5702@gmail.com)

Reversible Addition-Fragmentation chain-Transfer (RAFT) polymerization, since its introduction in 1998, is proved to be effective and versatile method of conferring living characteristics to radical polymerization [1]. It shows good result in molecular characteristics control and stands out for high tolerance to functional monomers and provides great opportunities for macromolecular architecture [2].

In recent years, new direction of researches has emerged in the context of RAFT polymerization. Considering the fact that, in general, more activated monomers (MAM) and less activated monomers (LAM) require agents with different structures to support chain transfer mechanism of reaction, there were attempts to synthesize more versatile RAFT agents, which can be used in polymerization of both types of monomers and their copolymerization. pH-switchable RAFT agents can exist in neutral and protonated forms and show different activity in MAMs and LAMs polymerization [3].

pH-switchable RAFT agents 1-cyano-1-methylethyl (phenyl)(pyridin-4-yl)-carbamodithioate (CMPC) and 1-cyano-1-methylethyl (4-methoxyphenyl)(pyridin-4-yl)-carbamodithioate (CMPCM) were synthesized (scheme 1). Reversible addition-fragmentation chain-transfer (RAFT) polymerization of styrene, vinyl acetate, methyl methacrylate and methacrylate was carried out. It was shown that presence of considered compounds affects molar mass distribution and kinetic features, realizes supposed mechanism of RAFT polymerization and supports controlled chain grow of investigated monomers, except for methyl methacrylate (scheme 1).

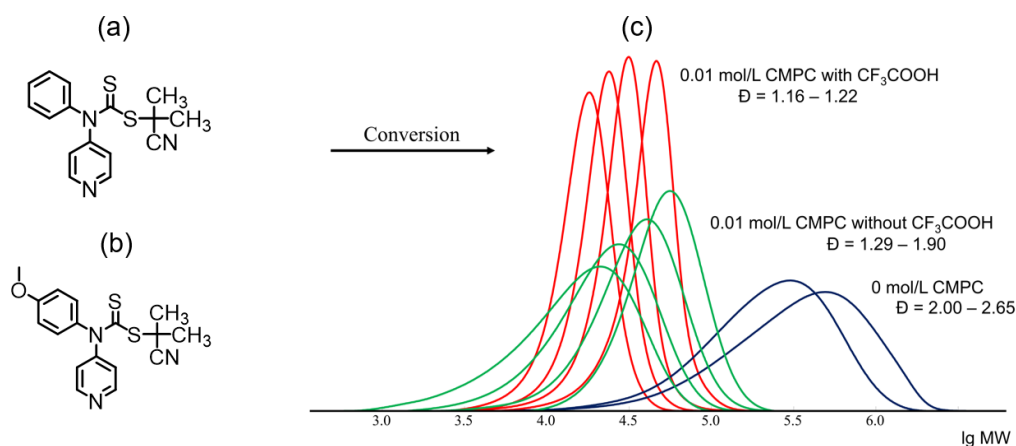

**Scheme 1.** (a) Structure formula of CMPC; (b) structure formula of CMPCM; (c) SEC curves normalized by the unit area for polymerization of styrene in presence of CMPC

Different effect of agents on polymerization in presence of protic acids was investigated. It was shown that protonated form of both agents provides better control over polymerization of styrene and methacrylate (more-activated monomers), while neutral form more suitable for vinyl acetate polymerization (less-activated monomer). CMPC showed greater activity in all considered cases in comparison with CMPCM.

## References

- [1] *European Polymer Journal*. **2021**, 159, 110713  
 [2] *Handbook of RAFT polymerization*. – John Wiley & Sons. **2008**  
 [3] *Macromolecules*. **2012**, 45, 4205-4215

## POLYEPOXIFURANS BASED ON DIFURFULIDENACETONE

Yumanova L.A., Vasilyeva S.Yu., Nasakin O.E.

Chuvash State University, Cheboksary, Russia  
Student[Lyuba.yumanova@mail.ru](mailto:Lyuba.yumanova@mail.ru)

The growing demand from the automotive industry is one of the key factors contributing to the expansion of the furan resin market. Furan resins are often used to manufacture lightweight and highly efficient composite materials, which are increasingly used in the automotive sector to reduce vehicle weight and improve fuel efficiency. Brake pads and other components requiring high temperature resistance and chemical resistance are also manufactured using furan resins. Due to their exceptional qualities, including high thermal stability, chemical resistance and low shrinkage, furan resins are often used in the creation of composites, adhesives, putties and coatings. Furan resins are also used to modify epoxy resins. Epoxy resins, despite a number of excellent physical and mechanical properties, have negative properties - high viscosity, which worsens technological parameters, relatively low crack resistance and toughness of composites, flammability. In this regard, the development of new polymer materials based on mixtures of epoxy and furan resins, such as difurfulidenacetone (DFA), is of interest.

Polyfuranepoxides were obtained by mixing ED-20 and DFA epoxy resin in different proportions. Polyethylene polyamine (PEPA) was added as a hardener. The amount of hardener was taken as 20% of the mass of ED-20 and DFA in the mixture. The curing of epoxifuranes was carried out stepwise: first at room temperature 20-25 °C for 2 hours and 4-6 hours at a temperature of 80-100 °C. This is due to the fact that at the first stage, DFA actively reacts with amines. Presumably, in the first stage, a reaction occurs between the ketone group of DFA and the amine with the formation of azomethine and the release of water. At the same time, unspent primary amine groups can react with epoxy groups of ED-20 resin. When heated, the amine groups of the PEPA hardener can interact with unsaturated DFA groups to form aminofuran adducts. The stages of adduct formation are shown in scheme 1.

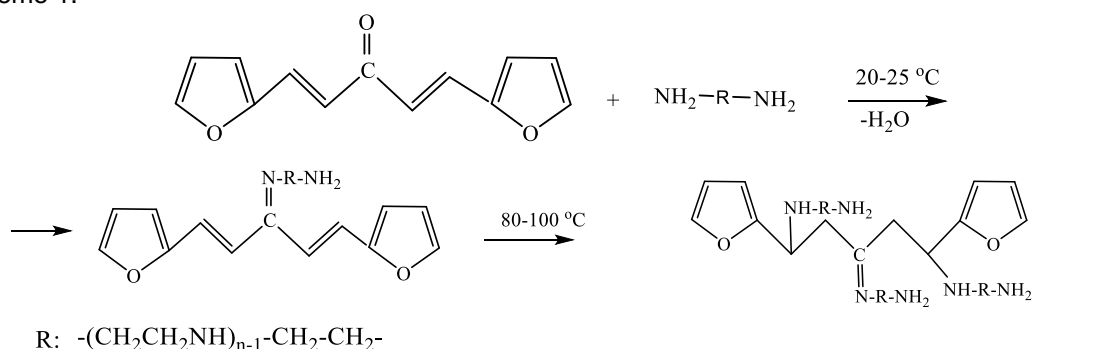
**Scheme 1.** Formation of an aminofuran adduct.

The curing of epoxy resins involves two stages: the formation of linear molecules and spatial crosslinking, which results in the formation of a three-dimensional mesh of meshes. Scheme 2 shows these stages.

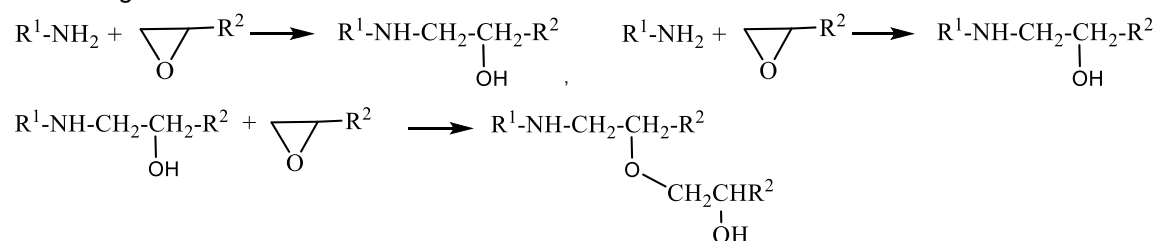
**Scheme 2.** The curing stages of the epoxy resin.

The resulting polyepoxifuranes were glossy dark brown hard polymers with a glass transition temperature of 65-75 °C, tensile strength of 55-70 MPa, compressive strength of 112-139 MPa.





# **NEW TECHNOLOGIES AND MATERIALS FOR CHEMICAL ANALYSIS**



# **KEYNOTE & INVITED SPEAKERS**



## KEYNOTE SPEAKER



**Dr. Sci., Chief Researcher, Vladimir Apyari**

*Division of Analytical Chemistry, Department of Chemistry,  
Lomonosov Moscow State University, Moscow, Russia*

**Gold and Silver Nanoparticles in  
Spectrophotometric/Colorimetric Analysis:  
Behavior, Peculiarities, Opportunities**

## INVITED SPEAKERS

**Dr. Sci., Prof. Dmitriy Kirsanov**

*St Petersburg University, St. Petersburg, Russia*

**Machine Learning, Artificial Intelligence and  
Chemometrics in Analytical Chemistry - What's the  
Difference?**



**Dr., Assoc. Prof., Olga Osmolovskaya**

*St Petersburg University, St. Petersburg, Russia*

**Inorganic Nanosorbents for Solid-Phase  
Microextraction: Preparation, Most Important  
Parameters and Examples of Application**

**Dr., Prof. Andrey Shishov**

*St Petersburg University, St. Petersburg, Russia*

**Deep Eutectic Solvents in Microextraction Methods  
of Analysis**



GOLD AND SILVER NANOPARTICLES IN SPECTROPHOTOMETRIC/COLORIMETRIC ANALYSIS:  
BEHAVIOR, PECULIARITIES, OPPORTUNITIES

*Apyari V.V.<sup>1</sup>, Furletov A.A.<sup>1</sup>, Matiash M.V.<sup>1</sup>, Tolmacheva V.V.<sup>1</sup>, Dmitrienko S.G.<sup>1</sup>, Zolotov Yu.A.<sup>1,2</sup>*

<sup>1</sup> Lomonosov Moscow State University, Chemistry Department, Moscow, Russia

<sup>2</sup> Kurnakov Institute of General and Inorganic Chemistry, Moscow, Russia

Chief Researcher, ScD

[apyari@mail.ru](mailto:apyari@mail.ru)

Gold and silver nanoparticles (NPs) as well as their nanocomposites have been widely proposed in recent decades for different purposes of analytical chemistry [1-2]. Among other metal nanoparticles, one of the most distinctive features of these objects is their surface plasmon resonance. It results in the non-classical optical properties, which have been utilized in numerous applications within the field of spectrophotometric/colorimetric analysis. Such tunable parameters of NPs as size, morphology, and aggregative state strongly affect their spectral characteristics in the visible range. This opens new possibilities, which are unavailable for classical analytical reagents, to develop simple and inexpensive quantitative analytical methods and semiquantitative tests [3-4].

This report aims to systematize some patterns in behavior of NPs, to outline their peculiarities, and to show the opportunities arising from them for the spectrophotometric/colorimetric methods of analysis. The emphasis is primarily done on the features of label-free NPs, i.e. neither cases where NPs play the role of passive labels, nor where they carry some selective reagents and functional groups are discussed here.

Some peculiar effects of the nature of NPs and their stabilizers, charge, and morphology on their interaction with substances of different classes are considered. The behavior of both widespread citrate-capped NPs and some novel NPs stabilized with inert polymers are compared. The peculiarities of largely available spherical NPs as well as more sophisticated but easily prepared morphologies, such as nanorods and triangular nanoplates, are outlined. Finally, features of NPs in a colloidal solution are compared with the features of the same NPs in a nanocomposite with polyurethane foam.

Such processes with participation of NPs as aggregation, morphological transformation, change in the state of their surface as a result of covering with a metal layer, formation, and destruction, leading to significant spectral and color changes, which can be monitored both by spectrophotometry and visually, are discussed. Relationships between the nature and structure of substances and their influence on these processes are indicated, revealing tools for adjusting sensitivity and selectivity of the chemical analysis using NPs.

Finally, some opportunities of NPs in the determination of several classes of analytes (thiols, cationic compounds, anions, catecholamines, flavonoids, peroxides and some other compounds) are demonstrated.

### References

- [1] *Nanoanalytics. Nanoobjects and Nanotechnologies in Analytical Chemistry* / Ed. by Shtykov S.N. – Germany: de Gruyter, **2018**. – 446 p.
- [2] *J. Anal. Chem.* **2019**, *74*, 21–32
- [3] *Trends Anal. Chem.* **2020**, *130*, 115974
- [4] *Trends Anal. Chem.* **2023**, *166*, 117202

### Acknowledgements

This work was made within the State Contract of Lomonosov Moscow State University. AAAA-A21-121011990021-7 and according to the Development Program of the Interdisciplinary Scientific and Educational School of Lomonosov Moscow State University «The future of the planet and global environmental change».

MACHINE LEARNING, ARTIFICIAL INTELLIGENCE AND CHEMOMETRICS IN ANALYTICAL  
CHEMISTRY - WHAT'S THE DIFFERENCE?

*Kirsanov D.O.*

<sup>1</sup> St. Petersburg State University, St. Petersburg, Russia  
Professor, Doctor Sci.  
[d.kirsanov@spbu.ru](mailto:d.kirsanov@spbu.ru)

## INORGANIC NANOSORBENTS FOR SOLID-PHASE MICROEXTRACTION: PREPARATION, MOST IMPORTANT PARAMETERS AND EXAMPLES OF APPLICATION

*Osmolovskaya O.M.*

<sup>1</sup> St. Petersburg State University, St. Petersburg, Russia

Associated professor, Dr.

[o.osmolovskaya@nanolabspb.ru](mailto:o.osmolovskaya@nanolabspb.ru)

Solid-phase microextraction is a sample preparation method in which the analyte is extracted from the liquid or gas phase using small amounts of sorbent. The advantages of the method are the rapid reach of equilibrium, saving time and reagents, environmental friendliness and wide optimization possibilities. The latter can be divided into two broad areas - optimization of analysis parameters and optimization of sorbent parameters. Thus, the microextraction process can be considered from two positions - from the position of a specialist in analytical chemistry and a specialist in the field of materials science. In the latter case, the sorbent is putted at the forefront and special attention is paid to the study of its characteristics and to the design of the approaches to their specified variation.

If the efficiency of microextraction is considered from the point of view of the material, it is determined by the intensity of sorbent-analyte interaction, which can be realized through both physical and chemical adsorption. A distinctive feature of nanosorbents is the special surface composition and the presence of a large number of interaction centers.

The microextraction process consists of three stages: interaction of the analyte with the sorbent surface, sorbent collection and separation, and elution. Each of these stages, the features of its implementation and approaches to optimization will be discussed in the report from the point of view of the used material.

The work of materials scientists is aimed to develop a sorbent that would allow specialists in the field of analytical chemistry to achieve the required result. The sorption properties are controlled by varying the parameters of the material, which requires a specially designed synthesis. The most important parameters of nanosorbents are phase composition, size and shape, as well as surface composition. The origin of their impact on sorption properties and the ways to its optimization will be discussed in detail.

The most promising methods for fast, cheap and easily scalable synthesis of nanosorbents with a high control of size and shape are “wet” chemistry methods. The report will discuss the main methods for nanosorbents producing and the ways to regulate their parameters, as well as the features of nanoparticles formation.

The last part of the report will be devoted to a review of examples of the use of solid-phase microextraction for the determination of analytes of various natures, as well as a discussion of the challenges and problems facing scientists developing materials with improved sorption properties.

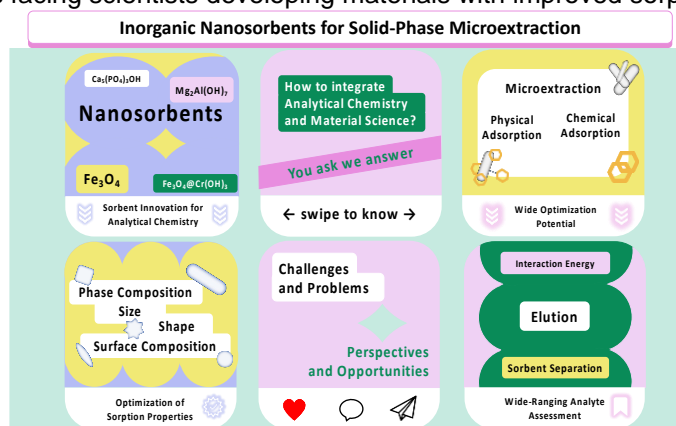

**Scheme 1.** Schematic Illustration

### Acknowledgements

Scientific research were performed at the research park of St. Petersburg State University: Centre XRD, Centre CCM, Centre ITCN, Centre CARM, Centre PMSI, Computing Centre, Centre OLMR, Centre Nanotechnology.

The author thanks the students and staff of Nanoparticles and Nanostructured Materials Synthesis and Research Group <https://nanolabspb.ru/en/home-en/>, who are actively working in the field of obtaining and characterizing of new materials and developing the original approaches to their production.

## DEEP EUTECTIC SOLVENTS IN MICROEXTRACTION METHODS OF ANALYSIS

*Shishov A.Y.*

St. Petersburg State University, St. Petersburg, Russia

Young scientist

[andrey.shishov.rus@gmail.com](mailto:andrey.shishov.rus@gmail.com)

Deep eutectic solvents (DES) are a special type of mixture formed from two or more low fusibility components that combine to form a liquid with a lower melting point than each of the individual components. These solvents have unique physicochemical properties and attract the attention of researchers in various fields. DESs are widely used in chemistry, biology, pharmaceuticals and other fields due to their ability to replace traditional organic solvents. Environmental safety, ease of preparation in the laboratory, and low cost of DESs have led to the fact that they have recently found increasing use in analytical chemistry. DESs are most widely used in analytical chemistry in microextraction methods for separation of analytes of various natures from various and complex objects.

The report will discuss both the analytical capabilities and limitations of DESs in microextraction approaches such as classical liquid-liquid microextraction, single-drop, dispersion, homogeneous, membrane and other types of microextraction, as well as issues of formation, decomposition and stability of DESs. The report will also present the latest trends in the field of automation of chemical analysis using deep eutectic solvents, as well as problems and limitations associated with the use of DESs in chemical analysis and the main prospects for the development of this area.

### **Acknowledgements**

The work was carried out with financial support from a grant from the Russian Science Foundation (project No. 24-13-00118). Scientific research was carried out in the resource centers of the St. Petersburg State University Science Park "Methods for analyzing the composition of matter, Thermogravimetric and calorimetric research methods, Center for diagnostics of functional materials for medicine, pharmacology and nanoelectronics, Prototyping Department."



# **ORAL & POSTER PRESENTATIONS**



# DETERMINATION OF DRUG ENANTIOMERS USING A VOLTAMMETRIC SENSOR MODIFIED WITH MOLECULARLY IMPRINTED POLYPYRROLE

*Abdullin Y.R.<sup>1</sup>, Nazzyrov M.I.<sup>1</sup>, Perfilova Y.A.<sup>1</sup>*

<sup>1</sup> Ufa State University of Science and Technology, Ufa, Russia

Student

[yaroslav\\_abdullin@list.ru](mailto:yaroslav_abdullin@list.ru)

Determination of enantiomers of drug compounds is a topical issue for medicine and analytical chemistry. The use of voltammetric sensors modified with molecularly imprinted polymers (MIPs) is a cheaper and more efficient method [1]. Polypyrrole (Ppy) is a superconducting, chemically and physically stable polymer with high specific capacitance. This series of properties makes it a good material for the creation of MIPs. The process of creating of MIPs consists of template interaction with the monomer, polymerization and removal of the template, after which pores specific to the original analyte are formed [2].

In this work, a sensor based on a glassy carbon electrode (GCE) modified with molecularly imprinted Ppy was developed for the determination of drug enantiomers. The Ppy was electrochemically polymerized on the electrode surface using cyclic voltammetry in the potential range of 0 to 1 V in a solution containing 100 mM LiClO<sub>4</sub>, 1.5 mM Py and 0.5 mM of analyte. The sensor was used for further analysis of enantiomers of bioactive drugs such as tryptophan, propranolol, atenolol and clopidogrel.

The thickness of the pyrrole film and its electrochemical properties can be controlled by varying polymerization parameters such as the scan rate and the number of cycles. The optimal parameters for the electropolymerization of Ppy were selected to achieve the highest sensitivity of the sensor and its stability. We chose a scan rate of 100 mV/s and 3 cycles of polymerization. The morphology of the resulting Ppy film was investigated using cyclic voltammetry, electrochemical impedance spectroscopy and scanning electron microscopy. The analytical performance of the sensor, including its selectivity towards structurally similar substances and in racemic mixtures of a single drug, as well as the reproducibility of results when analyzing biological fluids such as blood plasma and urine, were also studied.

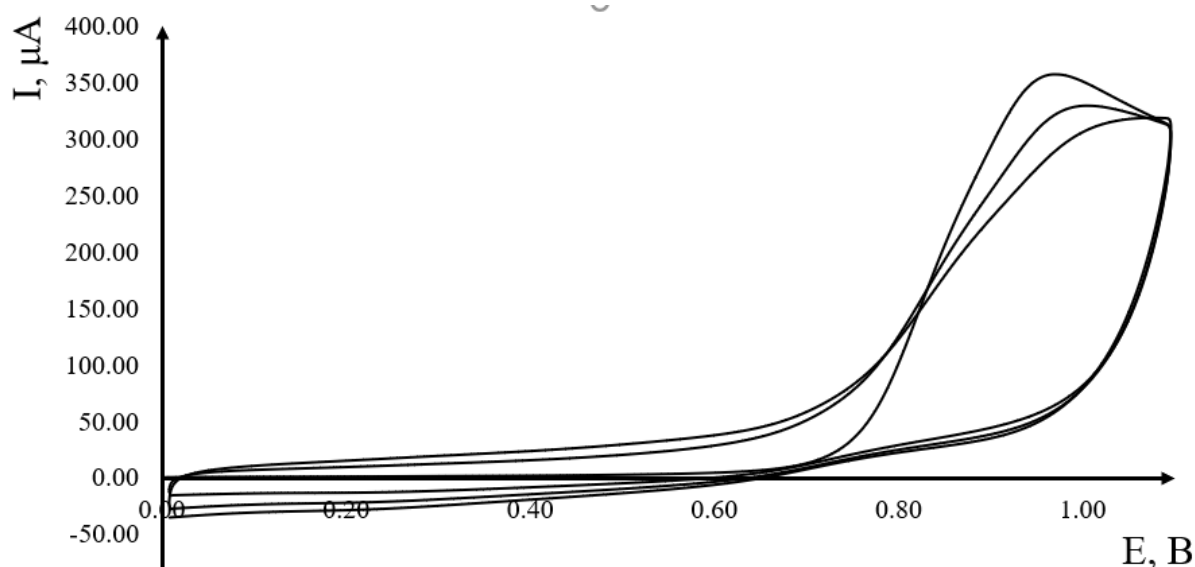

**Figure 1.** Cyclic voltammograms of electropolymerization of polypyrrole film.

## References

- [1] Yarkaeva Yu.A., Dymova D.A., Nazzyrov M.I., Zagitova L.R. Voltammetric sensor based on molecular imprinted polymer for lincomycin detection. *Chim. Tecno Acta*, 2023, V.10, No. 202310210. DOI: 10.15826/chimtech.2023.10.2.10.
- [2] Yarkaeva Yu. A, Maistrenko V.N., Dymova D.A., Zagitova L.R., Nazzyrov M.I. Polyaniline and poly(2-methoxyaniline) based molecular imprinted polymer sensors for amoxicillin voltammetric determination. *Electrochimica Acta*, 2022, V. 433, No. 14122. DOI: 10.1016/j.electacta.2022.141222.

# SENSING REACHING THE STARS: ZINC OXIDE MICROSTRUCTURE DEVELOPMENT FOR VITAMIN DETECTION

*Abramyan A.<sup>1</sup>, Golovin M.<sup>1</sup>, Zakharchenkova V.<sup>1</sup>, Lalov A.V.<sup>2</sup>, Stanković D.M.<sup>3,4</sup>, Bol'shakov O.<sup>1</sup>*

<sup>1</sup>Nanotechnology Education and Research Center, South Ural State University, Chelyabinsk, Russia

<sup>2</sup>N.D. Zelinsky Institute of Organic Chemistry, Russian Academy of Sciences, Moscow, Russia

<sup>3</sup>University of Belgrade, VINČA Institute of Nuclear Sciences - National Institute of the Republic of Serbia, Belgrade, Serbia

<sup>4</sup>University of Belgrade – Faculty of Chemistry, Belgrade, Serbia  
Graduate Student

[abramianad@susu.ru](mailto:abramianad@susu.ru)

We present the preparation and electrochemical evaluation of a vitamin B2-riboflavin (RF) sensor. Strategy for the synthesis of hierarchically structured ZnO in the form of microstars obtained by a simple hydrothermal method. Their physico-chemical properties were thoroughly studied using XRD, SEM c EDS, UV methods and PL, which made it possible to determine the crystallinity, the morphology of the sample, the elemental composition and defects ZnO. The lattice parameters for microstars ZnO are  $a=3.25 \text{ \AA}$ ,  $c=5.21 \text{ \AA}$ , with the displaying a shift of peaks to the right side, indicating an increase in the crystal lattice and a volume change to  $47.6 \text{ \AA}$  for microstars ZnO, suggesting the initial signs of defects in the wurtzite type ZnO structure. The band gap width was estimated to be approximately 3.07 eV using Taus graphs; some sources claim it to be 3.4 eV. The PL spectra of ZnO exhibit ultraviolet radiation from the near edge of the band along with a wide visible radiation band, with absorption bands at 667 nm and 777 nm attributed to oxygen vacancies ( $V_O$ ) and zinc vacancies ( $V_{Zn}$ ), respectively. The sample morphology reveals that zinc oxide exhibits a "star" shape where each spike averages around 5 microns in length, with the overall "star" length averaging 10 microns.

Hierarchically structured zinc oxide was used as a electroactive additive for carbon paste electrode which was studied with electrochemical impedance spectroscopy (EIS), cyclic voltammetry (CV) and differential pulse voltammetry (DPV). Hierarchical structure of ZnO improved electrochemical properties of the semiconductor toward riboflavin (RF) detection. Excellent charge mobility and low resistivity provided the CPE with an improved linearity range 0.1-0.8 and 1-10  $\mu\text{M}$  and a low limit detection 0.057 and 0.248  $\mu\text{M}$  respectively. It also demonstrated excellent analytical parameters such as an acceptable sensitivity of 0.9049  $\mu\text{A}$  per  $\mu\text{m}^{-1} \text{ cm}^{-2}$  for low concentrations and 2.9455  $\mu\text{A}$  0.9049  $\mu\text{A}$  per  $\mu\text{m}^{-1} \text{ cm}^{-2}$  for high concentrations. The repeatability and stability of the developed sensor were at a satisfactory level. The sensor's functionality has been tested on real samples with good recovery rates 105 % for Complex Vitamins B and 111 % for Beer. Thus, the proposed ZnO/CPE sensor can be effectively used to detect riboflavin in food and water in real time.

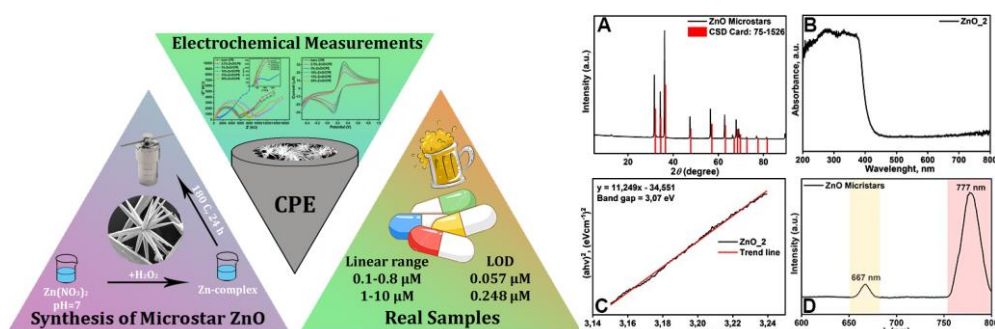

**Scheme 1.** Title of the scheme or figure.

## References

- [1] *Renewable and Sustainable Energy Reviews*. **2018**, *81*, 536-551
- [2] *Materials Today: Proceedings*. **2021**, *53*, 319-323
- [3] *Nano Express*. **2020**, *1*, 30028
- [4] *Thin Solid Films*. **2006**, *515*, 551–554
- [2] *Nanoscale. The Royal Society of Chemistry*, **2021**, *13*, 9160–9171

## Acknowledgements

This work was supported by the Russian Science Foundation (project No 24-13-20018).

## NEW MICELLAR POLYELECTROLYTES – MODIFIERS OF ELECTROPHORETIC SYSTEMS

*Adamova A.A., Kartsova L.A., Fetin P.A.*

St. Petersburg State University, St. Petersburg, Russia

1<sup>st</sup> year Master's student

[st117588@student.spbu.ru](mailto:st117588@student.spbu.ru)

Capillary electrophoresis (CE) is an actively developing method of separation and concentration that is currently undergoing significant evolution. The wide range of analytes determined in CE is primarily associated with the implementation of various separation modes by using modifiers of a capillary. That is why the urgent task is to create new modifiers, thanks to which it is possible to expand the analytical capabilities of the method.

The purpose of the study was to synthesize new multifunctional cationic polymer modifiers and evaluate their analytical capabilities in the separation of biologically active substances with various functional groups, including enantiomers.

The synthesis of the cationic micellar polymer poly-11-acryloyloxyundecyl-N-methylpiperidinium bromide (pAUMP-Br) was carried out according to the method [1]. Previously, for this group of substances it was established that both monomers and polymers have surface activity, can form stable micelles in solution at extremely low concentrations (0.001 M) and have a significant solubilization capacity, which allows them to be used for the implementation of various CE modes. A copolymerization reaction of the resulting AUMP monomer with acylated quinine was also carried out to obtain a modifier with a chiral tag (pAUMP-AQin-HCl) to identify the possibility of enantiomeric separation in the micellar CE mode. The structures of the substances were confirmed by NMR spectra.

Electrophoretic experiments showed that new substances modify the walls of a quartz capillary after it is washed with aqueous solutions of 0.01 M for an hour, generating an anodic electroosmotic flow (EOF). The micellar electrokinetic chromatography (MEKC) mode was implemented, which was confirmed by the separation of hydrophobic analytes - steroid hormones. Using the obtained modifiers, it was possible to significantly increase the efficiency and selectivity of the separation of catecholamines, aminoacids and steroid hormones. A special series of experiments on on-line concentration (field-enhanced stacking) was performed on model mixtures of catecholamines using modified capillaries.

The chiral copolymer pAUMP-AQin-HCl was examined for the possibility of separating enantiomers of ketoprofen. It was possible to separate the enantiomers using a double chiral system (quinine on the walls as a chiral selector, 2-hydroxypropyl- $\beta$ -cyclodextrin in the background electrolyte). Research in this direction is actively continuing.

Thus, it has been shown that new micellar polymers are promising modifiers of electrophoretic systems: they reverse the EOF, reduce analysis time, allow the determination of steroid hormones, catecholamines, and aminoacids with greater selectivity and efficiency, and can be used as chiral selectors for enantiomeric separation.

### References

[1] *Journal of Molecular Liquids* **2022**, 357, 119085

### Acknowledgements

This work was supported by the Russian Science Foundation (project No 24-13-00378).

## SORPTIONED SPECTROMETRIC DETERMINATION OF PHENOL AND ALKADERIVATIONS IN WATER

*Afanasyev A. O., Podolina E. A., Livanov D. R.*

Moscow Polytechnical University Electrostal department, Electrostal town, Russia

Student

[afanasev.anton.03@bk.ru](mailto:afanasev.anton.03@bk.ru)

Phenol and its alkaderivations are widely used as synthetic antioxidants for various materials, e. g. polymers. When polymers materials are ageing, the phenol escaping into the environment and water takes place. For alkaphenol determination in purified either waste or surface water, the development of preliminary phenol concentrating is necessary. For phenol concentrating the active coal MeKS (Scientific & production association "Neorganika", Electrostal) is proposed.

The aim of the given research is the method development of sorptioned-spectrometric determination of phenol and alkaphenol in water.

The objects of research are phenol, o-, m-, p-cresol of the "h-ch" gualification, active coal(AU) of the Mark medical stone sorbent (TC 2568-302-04838763-2007, ESPA "Neorganika, Electrostal town), acetone nitrite gualification chrom, ch., etanol 95%of PCFC Join stock company" Medhimprom" and etanol. The phenol concentration in contact solutions was determined by spectrometric way (spectrometric UNICO Mode 2800). Phenol sorption and desorption on active coal medical stone sorbent was done by the method described before. Value calculation of sorption and desorption, the received isotherms processing and sorption physic-chemical parameters were performed by computer programmes.

Phenol sorption and its alkaderivations under Vortexing conditions proceeds during five-six minutes (turbulance regime of mixing in static conditions). The kind of experimental phenol sorption isotherms corresponds to Lengmyur isotherms (physical sorption). On the base of the existing sorption theories thermodynamic parameters (Gibbs energy) were calculated. Phenol desorption was done in dynamic conditions, eluent water-acetonitrile, water-ethanol. Eluenting was carried out during 30 minutes with phenol output of 73-83 %.

Sorption-spectrometric method phenol and alkaphenol determination in water was developed. Five mlm of analysed water are put into centrifugal test-tube, acidulated to Ph 3-5, the 0,025 gr medical stone sorbent are added and mixed on the Vortex platform during 5-6 minutes with 15000 r/min speed. After that the received solution is filtered, activated coal (AU) is put into the column and the phenol desorption with binary solution either water-acetonitrile or water-ethynol is carried out for 30 minutes. The received eluate is spectrophotometried in UF-region (analysed length of the wave is 270nm, 274 nm). The developed method allows to determine separately phenol and cresol with the discovery limit being 0,1 LAC. The duration of the isolated analysed is 45-60 minutes, the relative error of calculation is not more than 1,5 %.

# POLY(METHYLENE GREEN) NANOPARTICLES AS ANCHORS OF PQQ GLUCOSE DEHYDROGENASE FOR ITS MOST EFFICIENT BIOELECTROCATALYSIS

*Alexandrovich A.S., Komkova M.A., Karyakin A.A.*

Moscow State University, Moscow, Russia

Student

[alexandrovichas@my.msu.ru](mailto:alexandrovichas@my.msu.ru)

The phenomenon of direct electron transfer (DET) or direct bioelectrocatalysis involves direct electron exchange between the enzyme cofactor and the electrode surface. Composed of dielectric polypeptide chain, proteins do not possess electronic conductivity. Accordingly, orientation of proteins at the electrode surface is essential to maintain the electroactivity of the cofactor. To date, several strategies have been applied to improve the efficiency of the direct bioelectrocatalysis: the use of conductive nanomaterials co-immobilized with the enzyme [1] to diminish the distance between the redox-active site and the electrode surface, thus facilitating the electron transfer, and the immobilization of enzyme on an electrode modifier with an affinity to the enzyme active site. For pyrroloquinoline quinone dependent glucose dehydrogenase (PQQ-GDH) polymers of azine dyes had been proved to be the most efficient anchors [2]. In this work, we proposed to combine both approaches – co-immobilize PQQ-GDH with poly(Methylene Green) (poly(MG)) nanoparticles [3] containing a phenazine group (co-substrate fragment) in its structure.

The electrochemical synthesis of colloid of electroactive poly(MG) nanostructures with the size of 70-150 nm during long-term potential cycling on the surface of graphite electrode was proposed. The ratio of polymer NPs to monomer in the colloid is controlled by the number of polymerization cycles. The colloid of the nanostructures was drop-cast on the electrode surface, and then the enzyme PQQ-GDH was immobilized on the modified electrodes by adsorption.

The potential dependence of the limiting electrocatalytic current of glucose oxidation was investigated for biosensors based on the formed poly(MG)|PQQ-GDH interfaces. The observed polarographic half-wave potentials of glucose oxidation by PQQ-GDH (-60 and 130 mV) adsorbed on the poly(MG) nanoparticles correspond to sequential pyrroloquinoline quinone redox transformations. On the one hand, within the precision of the reference electrode they equal those for the enzyme, covalently bound to carbon nanomaterial, the latter obviously assuming mediator-free electron transfer. On the other hand, the appearance of cathodic catalytic wave of glucose oxidation indicates that the direct bioelectrocatalysis occurs, since in case of mediated mechanism one would expect its anodic shift. Hence, bioelectrocatalysis of PQQ-GDH adsorbed over poly(MG) is determined by thermodynamics of the enzyme-catalyzed reaction, and thus can be referred to as the direct one.

The analytical performance of the developed biosensors was studied by chronoamperometry in the presence and absence of freely diffusing mediator phenazine methosulfate (PMS). Using a colloid of optimal composition to create a sensor coating, limiting bioelectrocatalytic currents up to 120  $\mu\text{A}\cdot\text{cm}^{-2}$  were achieved, while for the polymer film it was 70  $\mu\text{A}\cdot\text{cm}^{-2}$ . The ratio of mediator to non-mediator current of glucose oxidation reached values of 2-2.5, which is 2.5 times lower than for poly(MG) continuous films and order of magnitude lower than for the most sensitive sensors based on carbon nanomaterials. Thus, anchoring PQQ-GDH with poly(MG) nanostructures provides the most efficient direct bioelectrocatalysis for this particular enzyme.

The high sensitivity ( $5.5 \pm 0.5 \text{ mA}\cdot\text{M}^{-1}\cdot\text{cm}^{-2}$ ) and low detection limit of glucose (about 10  $\mu\text{M}$ ) makes it possible to use such biosensors for analyzing glucose content in sweat ( $[\text{glucose}]_{\text{sweat}} = 20 \div 400 \mu\text{M}$ ). The biosensors were adapted to operate in a microcapillary cell in power generation mode. Glucose concentrations in undiluted sweat of 5 volunteers (including diabetic patients) were measured. The relative changes in glucose concentrations determined with the developed biosensors correlate with the reference values measured with the first generation biosensors using glucose oxidase. This makes it promising to use the developed biosensors for non-invasive diagnosis of diabetes by sweat analysis.

## References

- [1] *Doklady Akademii Nauk SSSR*. **1978**, 240, 615
- [2] *Anal. Chem.* **2021**, 93, 12116
- [3] *Talanta* **2024**, 125219

## Acknowledgements

This work was supported by the Russian Science Foundation (project No 24-73-10015).

## A SMARTPHONE-BASED COLORIMETRIC DETERMINATION OF POLYDADMAC IN TREATED WASTEWATER

*Antonova A.N., Kochetkova M.A., Timofeeva I.I., Bulatov A.V., Shishov A.Y.*

St. Petersburg State University, St. Petersburg, Russia

Student

[alyonaant16@gmail.com](mailto:alyonaant16@gmail.com)

Currently much attention is focused on quality of water which is being released into the environment and supplied to people as tap water. Treatment of waste water is an important technological process and it includes the usage of polydiallyldimethylammonium chloride (polyDADMAC). PolyDADMAC is a cationic polyelectrolyte which acts as a flocculant and coagulant and helps to purify water from suspended insoluble particles [1]. Despite its valuable properties, excessive content of polyDADMAC in treated water can cause undesirable consequences, such as formation of carcinogenic nitrosamines on later stages of disinfection when polyDADMAC reacts with chlorine-containing compounds or ozone [2]. Therefore, determination of polyDADMAC in purified wastewater is an important analytical task. At the moment, there is no suitable techniques to determine polyDADMAC at the maximum residue level of 0.1 mg L<sup>-1</sup> [3].

Due to necessity in express *on site* determination of polyDADMAC in treated wastewater a smartphone-based colorimetric method has been developed. The method based on measuring the decrease in color intensity of an anionic dye, which reacts with analyte forming the colorless ion-pair associate. To increase the sensitivity, microextraction of the residual dye into a deep eutectic solvent is used that makes it possible to determine concentrations of polyDADMAC in a wide range. *On site* colorimetric analysis is ensured by smartphone with RGB application. The developed method was applied for the determination of polyDADMAC in treated wastewater samples.

### References

- [1] *Phys. Chem. Earth Parts A/B/C* **2014**, 72–75, 54
- [2] *SM J. Public Health Epidemiol.* **2017**, 3, 1043
- [3] *MU* 2.1.4.1060-01

### Acknowledgements

This project was financially supported by the St. Petersburg State University, project code 115679504.

# ANALYTICAL APPROACHES TO OBTAINING CHROMATOGRAPHIC PROFILES OF AMINO ACIDS AND GABA CONTENT IN GABA TEA BASED ON THE *COLCHIS* VARIETY BY HPLC-UV AND HPTLC METHODS

*Araslanova A.T.*<sup>1</sup>, *Bessonova E.A.*<sup>1</sup>, *Platonova N.B.*<sup>2</sup>, *Kartsova L.A.*<sup>1</sup>.

<sup>1</sup> St. Petersburg State University, St. Petersburg, Russia

<sup>2</sup> All-Russian Research Institute of Floriculture and Subtropical Crops, Sochi, Russia  
Student

[araslanova1903@gmail.com](mailto:araslanova1903@gmail.com)

$\gamma$ -Aminobutyric acid (GABA) is one of the major inhibitory neurotransmitter in the central nervous system, plays a crucial role in human metabolism. GABA has been found to have a positive effect on reducing anxiety, decreasing depression, and strengthening immunity under stressful conditions. Moreover, GABA displays a variety of other physiological functions, such as regulating cardiovascular functions, antihypertensive and antidiabetic activity, inhibiting the metastasis of cancer cells, and normalization of kidney function. Therefore, development of the production of food additives and food products with a high content of GABA has paid considerable attention. One of such product is a special tea, GABA tea, which contains a large amount of GABA. The content of other amino acids and polyphenolic compounds in samples of this tea is also increased compared to traditional green tea. The key difference between GABA tea and other tea products is the complicated anaerobic fermentation during withering operations. Currently, for the first time a technology of GABA tea production based on Russian raw materials, leaves of the tea cultivar 'Colchida' grown in the Krasnodar region, has being developed. The quality of a GABA tea is determined by the GABA content (at least 150 mg GABA/100 g dried tea) and its flavor. Therefore, an important task is to sensitive and express assess the content of GABA and other amino acids at all stages of GABA tea producing. For this purpose, the usage of HPLC and HPTLC methods is preferable.

So, this study aims to assess the levels of GABA and study chromatographic profiles of amino acids in various samples of GABA tea from leaves of "Colchida" cultivar tea growing in the humid subtropics of Russia. These tea products (black and green) were obtained under different conditions of anaerobic fermentation in inert atmosphere as well as the sequence of aerobic and anaerobic stages. They were provided by the All-Russian Research Institute of Floriculture and Subtropical Crops (Sochi).

Amino acid determination was carried out using reverse-phase HPLC with diode array detection after preliminary derivatization with dansyl chloride in the optimized conditions [1]. The resulting derivatives are stable and provide high sensitivity in detection by a spectrophotometric detector. Furthermore, a simple and selective method for determination of GABA and aminoacids profiles in tea extracts by HPTLC with videodensitometric detection on plates with microcellular was proposed. A qualitative reaction with ninhydrin was used for amino acid detection. The eluent composition was optimized to selectively separation of amino acids. The water content in both the mobile and stationary phases has a significant impact on the efficiency and selectivity of amino acid separation in HPTLC. This approach allows for rapid determination of GABA, crucial for quality control of the final product. It also serves as an alternative to traditional research methods in this field, such as assessing integral indicators like total amino acid content and total antioxidant activity.

Chromatographic profiles of amino acids in GABA tea samples were studied by HPLC and HPTLC under optimized conditions. Green and black tea samples produced by classical technology were used for comparison. It was obtained the best conditions, in which GABA content ranged from 100 to 160 mg per 100 g of tea. Additionally, GABA teas contain significant amounts of other important amino acids similar to green tea. The results of this research will be used by tea producer for further improvement GABA tea production technology.

## References

[1] Bessonova E. A., Araslanova A. T., Lazaretova A.I., Govorov I.E., Sitkin S.I., Kartsova L.A., Metabolic profiling of carboxylic and amino acids in biological fluids of patients diagnosed with endometriosis using liquid (HPLC-UV) and gas (GC-MS) chromatography. *J. Anal. Chem.* 2023, 78, 1469–1479

## Acknowledgements

This work was supported by the Russian Science Foundation (project №24-13-00378).

## LIQUID MICROEXTRACTION BASED ON “CLASSICAL” AND “GREEN” SOLVENTS FOR CHROMATOGRAPHIC DETERMINATION OF BIOTIN

*Barbayanov K.A., Veselova D.S., Timofeeva I.I., Bulatov A.V.*

St. Petersburg State University, St. Petersburg, Russia  
Student

[kirill.barbaaa@gmail.ru](mailto:kirill.barbaaa@gmail.ru)

“B”-group vitamins play a key role in the human body, actively involved in cellular metabolism and red blood cell synthesis, as well as facilitating cell growth and development [1,2]. Of particular significance within this group is vitamin B7, or biotin, which serves as a vital constituent of enzymes regulating protein and lipid metabolism, while also serving as a sulfur source crucial for collagen synthesis. It is imperative for the human body to receive a regular supply of biotin, however, its intake should be within the daily norm, since its deficiency or excess in the human body can lead to negative consequences: from deterioration of hair and nails to allergic reactions and increased blood sugar levels [3]. Biotin is predominantly sourced from various food products such as meats, eggs, yeast, grains and fish, with supplementary intake facilitated through nutritional supplements. Recently, more and more attention has been paid to its monitoring in various food products, especially those intended for infant consumption and animal feed.

Taken into account the complexity of multicomponent food matrices, there is a need for sample pretreatment. Thus, to isolate and enrich analytes, various extraction techniques are used, in particular, liquid microextraction. The difficulty in extraction of biotin arises from its high solubility in aqueous media and its potential occurrence in protein-bound states within the food matrices. Therefore, it is also necessary to include the hydrolysis process (acidic, alkaline or enzymatic [4]) into the sample preparation scheme to achieve complete conversion of biotin from its bound state. Also, today an urgent task is to find an environmentally friendly extraction solvent that can provide effective extraction of biotin. Such promising extractants can be terpenoids, deep eutectic solvents, solvents with “switchable” hydrophilicity, surfactants, etc. In this study, the extraction abilities of “classical” and “latest generation” or “green” solvents were studied for the following chromatographic determination of biotin in animal feed and baby food.

### References

- [1] *Medicine* **1998**, 204–246
- [2] *J. Health. Eat. and Diet.* **2019**, 2, 74–87
- [3] *J. Food Compos. Anal.* **2004**, 17, 767–776.
- [4] *Bioresour. Technol.* **2019**, 288, 121523

### Acknowledgements

This project was finally supported by the Russian Science Foundation (project no. № 24-23-00052, <https://rscf.ru/project/24-23-00052/>)



## CHEMILUMINESCENT PLATE-BASED METHODS FOR microRNA DETECTION USING ISOTHERMAL AMPLIFICATION

*Bodulev O.L.<sup>1</sup>, Solovjev A.M.<sup>2</sup>, Sakharov I.Yu.<sup>3</sup>*

<sup>1</sup> Moscow State University, Moscow, Russia  
research associate, Ph.D. in Chemistry

<sup>2</sup> Moscow State University, Moscow, Russia  
Ph.D. student

<sup>3</sup> Moscow State University, Moscow, Russia  
prof., D.Sc. in Chemistry  
[bodulevleg@mail.ru](mailto:bodulevleg@mail.ru)

MicroRNAs are short non-coding RNAs that regulate the expression of many eukaryotic genes. Nowadays, microRNAs are intensively studied as potential biomarkers for various diseases. This surge in interest is creating a growing need in analytical methods aimed to provide accurate and quantitative microRNA detection [1]. Using catalytic hairpin assembly (CHA) and the isothermal circular strand displacement polymerization reaction (ICSDPR) isothermal amplifications, two chemiluminescent plate-based methods for the detection of microRNA were developed. Overall, these detection systems comprise 3 steps of signal amplification (scheme 1): 1) isothermal nucleic acid amplification (CHA or ICSDPR), 2) streptavidin-polyperoxidase conjugate (SA-polyHRP) and 3) enhanced chemiluminescence reaction. For the first time, it was shown that the effectiveness of CHA reaction depends on the probe's annealing conditions. The method based on CHA allows to achieve microRNA-141 and microRNA-155 determination up to 100 fM [2] and 400 fM respectively [3]. In the case of ICSDPR-based method, the LOD for microRNA-141 detection was 51 fM [4]. The developed methods were successfully applied for the quantification of microRNA-141 and microRNA-155 in lysates of HeLa, CaCo2, MCF7 and HEPG2 cell lines [3-4].

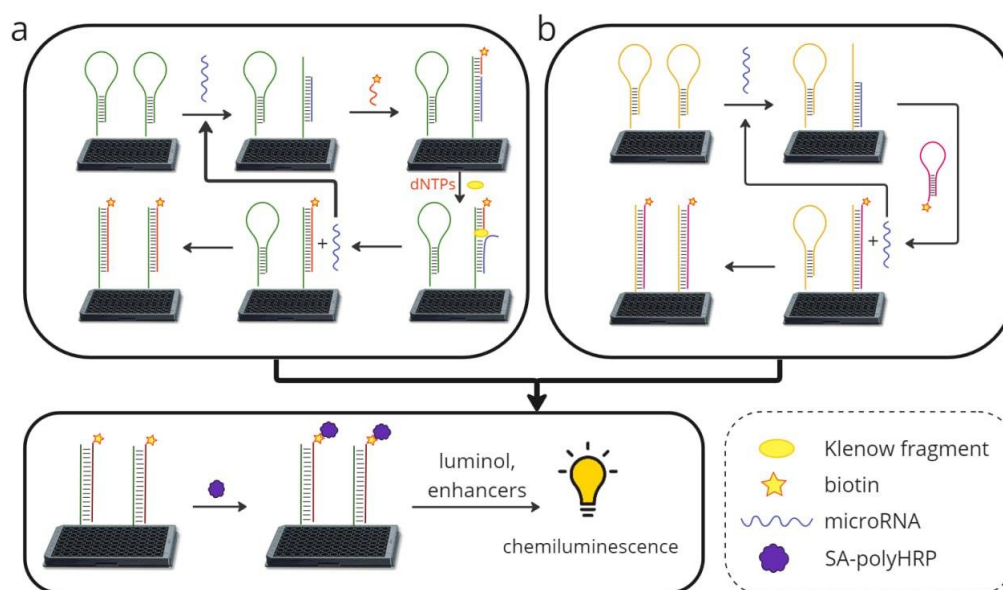

**Scheme 1.** Chemiluminescent plate-based methods for microRNA detection using a) ICSDPR and b) CHA. In the process of both isothermal amplifications microRNA catalyzes the formation of biotin-labeled duplexes on the plate surface that are further quantitatively measured using polyperoxidase conjugate (SA-polyHRP) and enhanced chemiluminescence.

### References

- [1] *Biochemistry (Moscow)* **2022**, 87, 425-442
- [2] *Anal. Chem.* **2021**, 93, 17, 6824–6830
- [3] *Biosensors* **2022**, 12(8), 570
- [4] *Analyst*, **2022**, 147, 4293-4300

### Acknowledgements

This work was supported by RSF (project No. 24-24-00123).

## PAINT IT BLUE: IDENTIFICATION OF SYNTHETIC AND NATURAL ULTRAMARINE VIA NIR SPECTROSCOPY AND CHEMOMETRICS

*Boichenko E.S.<sup>1</sup>, Khaydukova M.M.<sup>2</sup>, Andreev I.I.<sup>3</sup>, Sirro S.V.<sup>3</sup>, Kirsanov D.O.<sup>1</sup>*

<sup>1</sup>St Petersburg University, Saint Petersburg, Russia

<sup>2</sup>Institute of Human Hygiene, Occupational Pathology and Ecology, Saint Petersburg, Russia

<sup>3</sup>The State Russian Museum & ITMO University, Saint Petersburg, Russia

Senior researcher (PhD in Technical Sciences)

[ekaterina.boichenko@inbox.ru](mailto:ekaterina.boichenko@inbox.ru)

Ultramarine is a bright blue pigment used in art since the VI century. Natural ultramarine was available only to recognized masters of painting due to its high price, but the technology of its synthetic production, invented in 1828, made this beautiful pigment more affordable. Establishing the origin of ultramarine allows determining the later non-documented restorations and, most importantly, revealing the falsifications made with anachronistic dyes. Certainly, the development of nondestructive analytical methods is preferable due to the uniqueness and value of art objects under study. However, current methods imply taking of small probes of the pigments: for example, highly sensitive HPLC techniques [1], polarized light microscopy or IR spectroscopy in the middle spectral region. Energy-dispersive X-ray spectroscopy is a noninvasive method, but its application is limited to the determination of elemental composition of the sample. Its sensitivity is not sufficient for classification of natural and synthetic dyes, since the differences between them are subtle [2].

Near-infrared spectroscopy (NIR) with chemometric data analysis is an interesting approach that allows using fiber probes to avoid the sample preparation step and is suitable for classification of multicomponent objects. This approach has shown promising results in various fields, for example, as a nondestructive method of counterfeit detection [3].

In this study, we report the results of a classification of different dyes based on their NIR spectra, measured on 14 samples of ultramarine pigments (9 natural and 5 synthetic). Three replicates were prepared for each paint with different binders: whole egg, yolk and linseed oil. The NIR measurements were performed by a fiber optic probe 1,8 mm in diameter (Optofiber, Russia), connected to the portable NIR spectrometer (Avantes, Netherlands) within the 939-1799 nm spectral range. Also, the proposed approach was applied to several real objects of art from different centuries (paintings of canvas, icon on wood). The results of PCA and other methods of multivariate spectral data analysis demonstrate that the proposed approach allows classification of the paints according to the binder and to the origin of the ultramarine pigment.

### References

- [1] *Studies in Conservation* **2004**, 49(1), 115-130
- [2] *Vibrational Spectroscopy* **2009**, 49(1), 80-83
- [3] *Talanta* **2019**, 195, 662-667

# SIMULTANEOUS DETERMINATION OF SWEETENERS AND CARBOHYDRATES USING LABORATORY-DESIGNED ADSORBENTS BASED ON SILICA AND POLYSTYRENE-DIVINYLBENZENE IN HILIC MODE

*Borodina A.F., Chikurova N.Yu., Patrushev D.P., Gorbovskaia A.V., Chernobrovkina A.V., Shpigun O.A.*

Moscow State University, Moscow, Russia  
Student

[borodina.apollinaria@gmail.com](mailto:borodina.apollinaria@gmail.com)

Nowadays the use of natural (sugars and sugar alcohols) and artificial sweeteners is increasing. High intake of these substances can have a negative impact on human health; therefore, monitoring their levels in consumable products is essential. Usually, the determination of sweeteners is carried out in reverse-phase chromatography. However, since sugar alcohols and artificial sweeteners are hydrophilic in nature, their determination or simultaneous determination with sugars is promising by hydrophilic interaction liquid chromatography (HILIC). Applying HILIC and hydrophilic adsorbents with evaporative light-scattering detector (ELSD) can be one of the better options for simultaneous determination of sugars and sugar alcohols to achieve great retention and selectivity. The use of mixed-mode adsorbents can also ensure the retention of sweeteners including artificial, due to the implementation of various interactions, provide alternative selectivity and, finally, simultaneous separation with sugars.

The retention of sweeteners in HILIC mode on hydrophilic adsorbents based on silica [1, 2, 3] and mixed-mode adsorbents based on polystyrene-divinylbenzene [4] was investigated. The polymer-based phases with covalently grafted polyethylenimine and polyelectrolytes showed high selectivity, but lower efficiency for sugar alcohols in comparison with silica-based phases. The possibility of simultaneous separation of 6 alcohols and 5 sugars in 24 minutes using ELSD and gradient elution was shown on the amide adsorbent based on silica obtained by the Ugi reaction. The separation of 5 alcohols and 5 sugars in 14 minutes on the adsorbent modified with polyethylene glycol was demonstrated. Both adsorbents showed high efficiency for sugar alcohols (up to 46000 tp/m), while the efficiency for carbohydrates was almost twice higher on the adsorbent modified with polymer (up to 43000 tp/m) which made it preferable for simultaneous determination of sweeteners and sugars.

The selection of conditions for separation of artificial sweeteners was carried out. The need to use buffer solutions was shown to ensure acceptable peak shapes. The retention dependences of artificial sweeteners in relation to the pH and concentration of the buffer solution were investigated. The best chromatographic characteristics in relation to artificial sweeteners were demonstrated by mixed-mode adsorbents based on polystyrene-divinylbenzene.

The developed stationary phase based on silica and modified with polyethylene glycol was used for the determination of xylitol and sorbitol in oral hygiene products.

## References

- [1] *J. Chromatogr. A.* **2022.** 1666, 462804
- [2] *J. Chromatogr. A.* **2024.** 1715, 464561
- [3] *Moscow University Chemistry Bulletin.* **2021.** 76, 75
- [4] *Microchem. J.* **2024.** 199, 1

## Acknowledgements

The work was supported by Russian Science Foundation through the grant № 20-13-00140.

# ELECTROCHEMICAL DETECTION OF NITROFURAZONE USING A CARBON-PASTE ELECTRODE MODIFIED WITH LANTHANUM FERRITE

*Bulatova E.A.*<sup>1</sup>, *Golovin M.S.*<sup>1</sup>, *Mironova A. T.*<sup>1</sup>, *Zakharchenkova V, P.*<sup>1</sup>, *Nekorysnova N. S.*<sup>1</sup>

<sup>1</sup> South Ural State University, Department of Ecology and Chemical Engineering, Chelyabinsk, Russian Federation  
Student  
[bulatovaea@susu.ru](mailto:bulatovaea@susu.ru)

Nitrofurazone is an artificial broad-spectrum antibiotic that has good antibacterial activity against gram-positive and gram-negative bacteria. However, this antibiotic has carcinogenic, mutagenic and teratogenic effects, which necessitates the creation of an accessible method for detecting and preventing the release of nitrofurazone into the environment [1-2].

We have obtained lanthanum ferrite synthesized by simple annealing of a mixture of appropriate oxides. The crystal structure and purity of the lanthanum ferrite phase were determined by powder X-ray diffraction. The morphology of the sample is represented by aggregated particles that do not have a regular shape [3].

The lanthanum ferrite modified carbon paste electrode showed improved charge mobility and lower electron transfer resistance compared to the pure carbon paste electrode. The resulting sensor has high sensitivity, reproducibility and stability. The linear detection range of nitrofurazone is 4  $\mu\text{M}$  – 370  $\mu\text{M}$ , with a detection limit of 8.37  $\mu\text{M}$ . The effectiveness of the electrode modified with lanthanum ferrite was tested on real samples - tap water. The electrode showed high accuracy in determining nitrofurazone in tap water, and it can be argued that the resulting sensor is suitable for analysis in real samples.

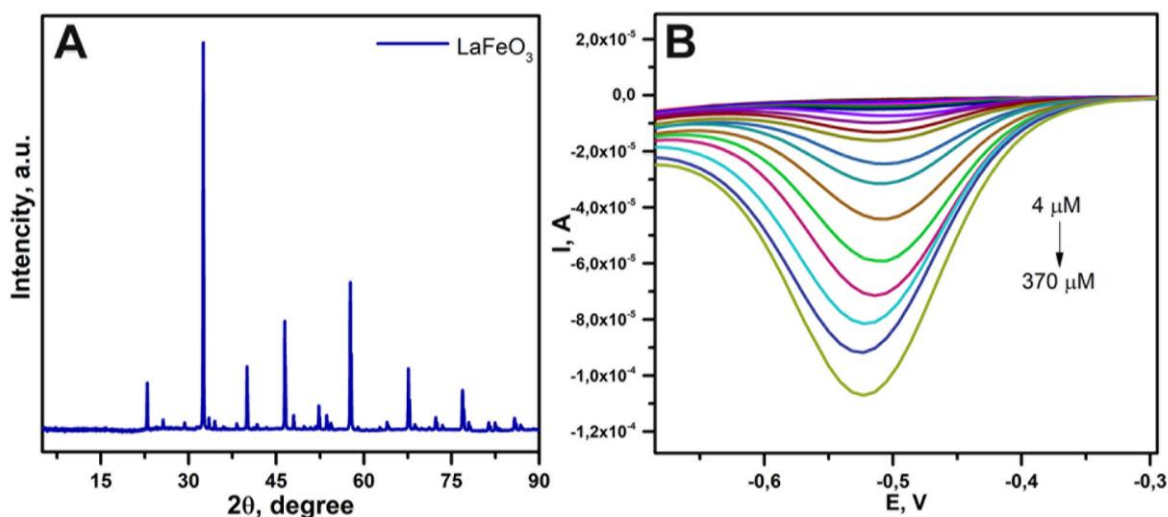

**Figure 1.** (A) X-ray diffraction pattern of the sample LaFeO<sub>3</sub>, (B) DPV curves for different concentrations of nitrofurazone in Britton-Robinson buffer at pH 5 range from -1 V to 1 V (part of the graph with recovery peaks is shown)

## References

- [1] *Int. J. Electrochem. Sci.* **2016**, *11*, 8546
- [2] *Sci. Total Environ.* **2023**, *904*, 166687
- [3] *Mater. Chem. Phys.* **2024**, *313*, 128709

## Acknowledgements

The work was carried out within the framework of the mega-grant “Innovations for air and water purification, reducing the carbon footprint: nanomaterials and nanocomposites, photocatalytic and electrochemical approaches”, leading scientist Stankovic Dalibor Miodrag (project No 220-4120-8031).

## SIMULTANEOUSLY DETERMINATION OF SHORT- AND LONG-CHAIN FATTY ACIDS BY HPLC IN THE FORM OF DERIVATIVES WITH 3-NITROPHENYLHYDRAZINE IN BIOLOGICAL OBJECTS

*Butorlin O.S., Bessonova E.A., Karstova L.A.*

St. Petersburg State University, St. Petersburg, Russia

Student

[olbuse@mail.ru](mailto:olbuse@mail.ru)

Saturated fatty acids (SFAs) are the most important metabolites involved in the regulation of physiological processes in the body. According to the length of the carbon chain, fatty acids are divided into short-chain (C1 - C6, SCFA), medium-chain (C7 - C12), long-chain (C13 - C21) and very long-chain ( $\geq$ C22) fatty acids. Numerous metabolic studies shown that SFAs can be potential biomarkers of many metabolic disorders, such as obesity and diabetes, inflammatory processes, diseases of the gastrointestinal tract. It has been found that cardiovascular, neurodegenerative and oncological diseases also closely correlate with changes in the level of free fatty acids. However, in most studies, only a limited range of analytes is determined. In addition, although all monobasic fatty acids have a similar chemical structure, the joint determination of low- and high-molecular fatty acids is a difficult analytical task: optimization of conditions is required for each group of analytes. The traditional method for determining fatty acids is gas chromatography. However, due to the high volatility of short-chain fatty acids, most of the proposed approaches to derivatization cannot be used in the determination of these analytes in biological objects due to losses during sample preparation. An alternative option for determining metabolites is the use of high-performance liquid chromatography (HPLC). Thus, the development of analytical approaches for the joint determination of SFAs with different alkyl radical lengths in biological objects by HPLC was the aim of this study.

Condition for the selective separation of 18 fatty acids (C1-C18) by reverse-phase HPLC in the form of derivatives in the gradient elution mode was optimized. 3-nitrophenylhydrazine (3-NPH) was chosen as a derivatizing agent for the determination of carboxylic acids due to the mild reaction conditions, high degree of conversion, stability of the derivatives obtained and the possibility of their UV and MS detection. However, the formation of reaction by-products having similar retention parameters with SGFA makes it difficult to determine them during spectrophotometric detection. The problem was solved using MS detection. The main factors influencing the parameters of the separation of derivatives (pH of the mobile phase (pH 7.0, 3.0), the nature of the solvent, the profile of the gradient regime) have been established. The conditions of MS detection in negative polarity in the monitoring mode of multiple reactions (MRM mode) have been optimized. Since the available information on the conditions for the derivatization of carboxylic acids with 3-NPH varies greatly, we carried out an independent optimization of the conditions of this reaction. The solvent nature of the reagents, temperature and reaction time were varied. The highest intensity of chromatographic peaks of the obtained derivatives was achieved using a 70% acetonitrile solution as a solvent for derivatization reagents, at a temperature of 60°C, and a time of 20 min. An assessment of the metrological characteristics of the proposed approach has been carried out. The detection limits were 1-10 ng/ml. Chromatographic profiles of organic acids in the blood serume of patients with endometriosis and uterine myoma were obtained. It should be noted that the developed approach has great prospects, since it provides the determination of amino acids, aldehydes and ketones in a similar way, which also easily react with 3-NPH in the conditions found for carboxylic acids.

The researchers express their gratitude to the Research Center "Methods of Substance Composition Analysis" of the SPbSU Research Park for technological support of the research.

### **Acknowledgements**

This work was supported by the Russian Science Foundation (project No 24-13-00378).

# WATER AND IONS MOBILITY IN LiCl-CsCl-H<sub>2</sub>O TERNARY SOLUTION. A MOLECULAR DYNAMICS SIMULATION STUDY.

*Cheremensky S.O.<sup>1</sup>, Egorov A.V.<sup>1</sup>*

<sup>1</sup>St. Petersburg State University, St. Petersburg, Russia  
Student  
[st087373@student.spbu.ru](mailto:st087373@student.spbu.ru)

Recently it was found [1] that LiCl-CsCl-H<sub>2</sub>O ternary aqueous solution is a promising electrolyte for batteries. To optimize the selection of the ratio of solution components, it is necessary to identify the mechanisms of microstructure formation as well as the main factors affecting the molecular mobility in the ternary systems. In the present study the molecular dynamics simulations method was employed for this purpose. In total, 8 systems: 6 ternary and 2 binary solutions, were simulated (see Figure 1).

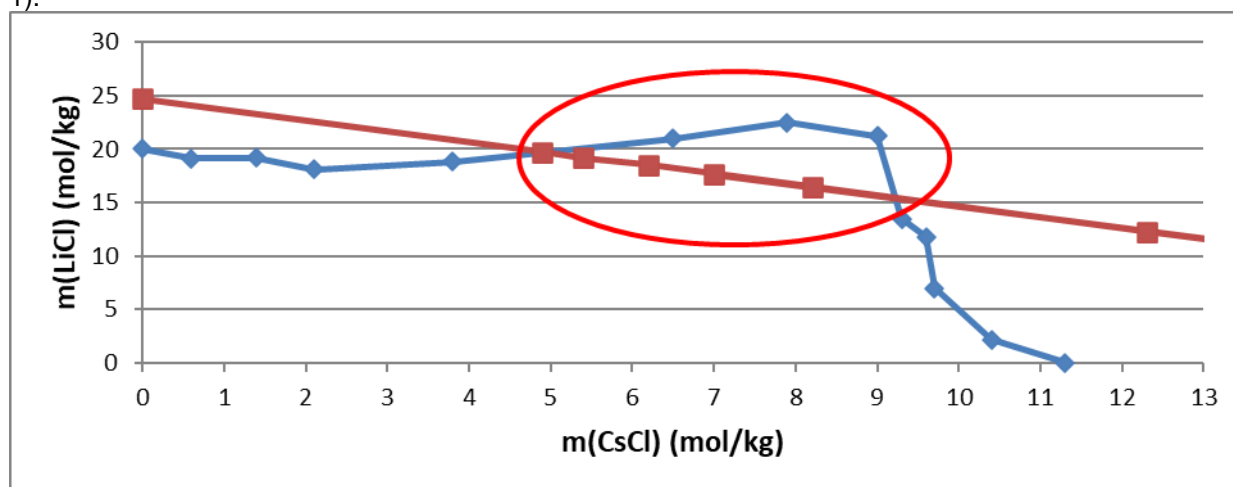

**Figure 1.** Solubility isotherm at 298 K of the LiCl-CsCl-H<sub>2</sub>O system [1] – the blue line, simulated concentrations – the red one. The concentration range of the greatest interest is highlighted.

In the present study, the MDynaMix v.5.0 package was used for modeling [2]. All systems were simulated in an isothermal-isobaric ensemble (25°C, 1 atm.) in a cubic cell with periodic boundary conditions. The SPC/E water model [3] was used to describe the solvent molecules. To model the interaction of Li, Cs and Cl ions, the potentials given in Refs. [4-6] were employed. The equations of motion were solved using Verlet algorithm with a time step of 2 fs. The coulombic interactions were calculated using the Ewald method. Constant temperature and pressure were maintained using the Nose-Hoover algorithm. The equilibration time for each model system was 1 ns, simulation time – 1 ns.

The effect of changing the Cs to Li cation ratio on the composition and stability of ions solvation shells, the diffusivity of solution components, and reorientational motion of water molecules in LiCl-CsCl-H<sub>2</sub>O ternary solution was studied in detail.

## References

- [1] Cell Rep. Phys. Sci. **2022**, 3, 10068
- [2] Comp. Phys. Comm. **2000**, 128, 565
- [3] J. Phys. Chem. **1987**, 91, 6269
- [4] J. Chem. Phys. **1992**, 96, 6970
- [5] Chem. Phys. Lett. **1994**, 227, 211
- [6] J. Chem. Phys. **1994**, 100, 3757

# QUALITATIVE ANALYSIS OF VOLATILE COMPOUNDS OF LAVENDER FLOWERS BY TD-GX-MS METHOD DURING THEIR PASSIVE SORPTION ON MONOLITHIC SORPTION MATERIALS BNR-SiC

*Chichkanova E.S<sup>1</sup>*

<sup>1</sup>M.V. Lomonosov Moscow State University, Chemistry Department, Moscow, Russia  
Student

[chichkanova.ekaterina@mail.ru](mailto:chichkanova.ekaterina@mail.ru)

Essential oils are mixtures of volatile organic substances produced by essential oil plants and have a characteristic odor, used to replace synthetic antioxidants and antimicrobials in phytotherapy. One of the most popular and safe floral-scented fragrance oils is lavender oil. When investigating the chemical composition of the aromatic parts of a plant, an extract is usually first obtained and directly introduced into a chromatographic system. However, not those substances that make up the aroma of lavender at room temperature can be extracted and it is advisable to use the method of passive sorption of volatile substances with their subsequent thermal desorption and determination by gas chromatography with mass spectrometric detection. One of the key issues here is the selection of a suitable sorption material.

Recently we have synthesized and for the first time used for analytical purposes a composite monolithic material based on butadiene-nitrile rubber and silicon carbide [1].

It is shown that this material captures almost the whole range of organic compounds and is not inferior to Tenax TA in sorption/desorption efficiency and superior to Tenax TA in thermostability. The chromatograms of lavender components obtained by passive sorption on Tenax TA and BNR-SiC composite are very similar and contain 33 and 39 peaks, respectively. The chromatograms obtained identified such classes of compounds as mono- and sesquiterpenes, their oxygenated derivatives, terpene alcohols, aromatic hydrocarbons, heterocyclic compounds, phenols, glycerides, and fatty acids. A total of 37 compounds were identified (Match Factors over 700 and retention indices), some of them for the first time.

This approach of passive sorption on BNR-SiC sorbent followed by thermal desorption GC/MS fingerprint analysis can help to approximate the compositional diversity/proximity for different multi-herb samples containing several groups of volatile terpene compounds.

## References

[1] Journal of Analytical Chemistry, **2023**, 78, 48.

## Acknowledgements

*The study was carried out using the equipment of the Central Collective Use Center of Moscow State University Technologies for Obtaining New Nanostructured Materials and Their Comprehensive Study, acquired by Moscow State University under the program for updating the instrumentation base within the framework of the national project "Science" and the Development Program of Moscow State University.*

# MONITORING THE STATE OF CHARGE OF ANTHRAQUINONE-VANADIUM REDOX FLOW BATTERY ELECTROLYTES

*Chikin D.V.<sup>1,2</sup>, Loktionov P.A.<sup>1</sup>, Speshilov I.O.<sup>1</sup>, Pichugov R.D.<sup>1</sup>*

<sup>1</sup> Mendeleev University of Chemical Technology of Russia, EMCPS Department, Moscow, Russia

<sup>2</sup> Moscow State University, Faculty of Fundamental Physical and Chemical Engineering, Moscow, Russia

PhD Student

[chikin.d.v@muctr.ru](mailto:chikin.d.v@muctr.ru)

Organic electrolytes are promising candidates for application in redox flow batteries (RFB). Therefore, the number of studies of various organic substances, mainly water-soluble ones, is growing every year. Special attention is paid to anthraquinone sulfonic acids (AQDS), which have relatively high solubility in aqueous solvents, fast kinetics of redox reactions at electrodes, and a suitable redox potential for use as RFB negolyte. Since 2014, research has been actively conducted on anthraquinone-bromine RFBs, in which the negolyte is a sulfuric acid solution of anthraquinone-2,7-disulfonic acid (AQDS-2,7), and the posolyte is a solution of bromine in hydrobromic acid [1]. Such a battery currently shows a maximum power of 1 W/cm<sup>2</sup> and an energy efficiency of 88 % [2]. However, further commercialization of anthraquinone-bromine RFB is significantly complicated by the cost of pure sodium anthraquinone sulfonates and the relatively high content of toxic Br<sub>2</sub> in the system.

To eliminate the above-mentioned factors that prevent the further spread of RFBs based on anthraquinone sulfonic acids, a crude mixture of anthraquinone sulfo derivatives (ASM), obtained by a well-known anthraquinone sulfonation method by oleum, can be utilized as a battery negolyte. The use of ASM provides significant cost reduction while presuming the key characteristics of the battery. This approach was successfully demonstrated in our previous work [3]. In addition, the Br<sub>2</sub>/Br<sup>-</sup> pair can be replaced by the safer, well-studied and commercially used vanadium redox pair V<sup>5+</sup>/V<sup>4+</sup>. The applicability of this battery is already demonstrated on not only single cells of anthraquinone-vanadium RFBs [4], but also kilowatt stacks based on such electrolytes [5].

However, there reliable state of charge monitoring for this system has not been demonstrated yet. This work investigates the possibility of monitoring the state of charge of redox flow battery electrolytes with ASM-based negolyte and vanadium posolyte using coulometric sensors (fig. 1). The SOC values obtained using this approach were verified by the coulomb counting. In addition to information about the SOC (the estimation error was no more than 8 %), the results obtained make it possible to estimate the net of reagent flux of two half-cells, as well as the degree of self-discharge of electrolytes, which under unoptimized conditions reaches more than 4 %/day for ASM.

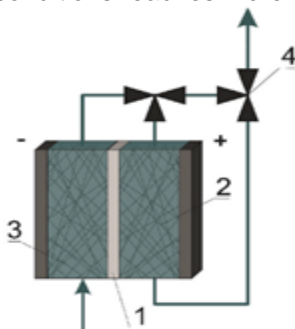

**Fig. 1.** Configuration of coulometric sensor (1 – membrane; 2 – cathodic half-cell with electrolyte sample of interest; 3 – half-cell of ideally non-polarized anode; 4 – 3-way valves) [6]

## References

- [1] *Nature* **2014**, 505 (7482), 195–198
- [2] *J. Electrochem. Soc.* **2016**, 163 (1), A5010–A5013
- [3] *Membranes (Basel)*, **2022**, 12 (10), 912
- [4] *J. Power Sources* **2023**, 569, 233015
- [5] *Appl. Energy* **2024**, 353, 122171
- [6] *J. Power Sources* **2023**, 553, 232242

## Acknowledgements

This work was supported by the Russian Science Foundation (project № 21-73-30029; reference to the project information: <https://rscf.ru/en/project/21-73-30029/>).



# EVALUATION OF THE ANALYTICAL CAPABILITIES OF HEADSPACE SINGLE-DROP MICROEXTRACTION FOR GAS CHROMATOGRAPHIC DETERMINATION OF ETHANOL IN SOFT DRINKS

*Davletbaeva K.N., Rodinkov O.V.*

*Student, bachelor*

St. Petersburg State University, St. Petersburg, Russia

[st097656@student.spbu.ru](mailto:st097656@student.spbu.ru)

A current challenge in modern analytical chemistry, the solution of which is aimed at protecting health and improving the quality of life, is the determination of ethanol impurities in non-alcoholic beverages. Standard analytical methods are based on headspace gas chromatographic analysis, in which the gas phase in contact with the liquid sample is analyzed. However, in this case, the concentration of ethanol in the gas phase turns out to be almost 5-7 times lower than in the liquid, which limits the sensitivity of the analysis. In this regard, it seems more rational to analyze not the equilibrium gas phase, but the microdrop present in this phase – headspace single-drop microextraction - one of the recently proposed methods for isolation and preconcentration [1]. In this case, the concentrations in the analyzed liquid and in the water microdrop should be approximately the same, thereby enabling a multiple increase in the sensitivity of the analysis [2].

The aim of this work is to evaluate the analytical capabilities of headspace microextraction into an aqueous drop for the determination of ethanol in non-alcoholic beverages – kvass, non-alcoholic beer, and fruit juices.

The influence of the distance between the drop and the surface of the analyzed liquid, the contact time of the phases, agitation, and the ratio of the geometric volumes of the aqueous sample and gas phase in the sample vial on the analytical signal were investigated. It was found that the maximum repeatability of the analysis results is ensured by using the internal standard method, with isopropanol being the most rational choice. The limits of detection of ethanol and the error in the analysis of various non-alcoholic beverages are relatively weakly dependent on the type of beverage. The limit of detection of ethanol when implementing the proposed analysis scheme was approximately 10<sup>-5</sup>% v/v for all analyzed objects.

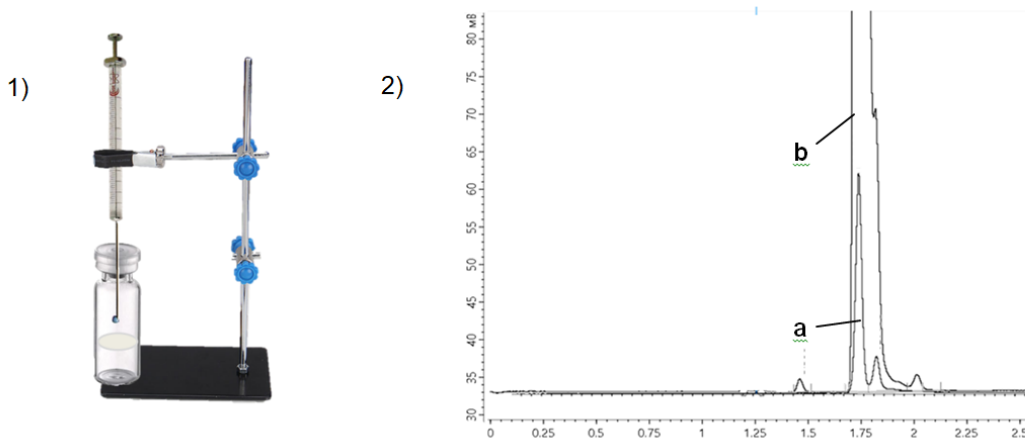

**Fig. 1.** Setup for headspace single-drop microextraction.

**Fig. 2.** Comparison of ethanol peaks at 0.1% v/v concentration in aqueous solution.  
a - headspace analysis; b - headspace single-drop microextraction.

The practical implementation of drop microextraction is very simple (Fig. 1). To carry it out, a regular gas chromatography microsyringe, a stand, and a penicillin vial with a polymer septum are required. The microdrop (1  $\mu$ L) is held for 6 minutes at the tip of the microsyringe needle, and then the drop is drawn into the microsyringe and injected into the gas chromatograph injector. As an illustration, Figure 2 compares the ethanol peaks in the case of the traditional HS variant and headspace single-drop microextraction when analyzing non-alcoholic beer.

## References

- [1] *Trends Anal. Chem.* **2015**, 71, 194
- [2] *Journal of Analytical Chemistry* **2020**, 75 (1), 1

## QUANTIFICATION OF FATTY ACIDS OLIGOMERS USING GC AND GC-MS METHODS

*Demidenko E.S., Botin A.A., Khasykova V.V., Podlesnova E.V.*

Gazpromneft – Industrial Innovations, LLC  
Researcher  
Demidenko.ES@gazprom-neft.ru

Fatty acids oligomers are common components of reagents in the petrochemical and oil refining industries [1], and therefore there is often a need to determine their content in a particular commercial product. To date, many different approaches to the quantitative determination of fatty acids oligomers have been proposed, but none of them is accessible for routine analysis due to increased instrumental and procedural complexity and cost, or does not provide the necessary measurement accuracy.

In this work, we propose a gas chromatography (GC) on-column method with flame ionization detection for the quantitative determination of fatty acids oligomers. For the analysis of high-boiling components, this method seems promising, since such chromatographic separation does not require rapid complete evaporation of the entire sample volume [2]. It is important that the analysis is performed on a simple gas chromatograph, which makes the method accessible and suitable for routine analysis of chemical reagents.

Analytical conditions and column parameters suitable for the separation and elution of fatty acids oligomers were selected. The analyzed samples are mixtures of monomeric and oligomeric components in the form of a solution in toluene. Before injection into the chromatograph, the samples were silylated. Peaks of the analytes were identified in the obtained chromatograms, and a linear dependence of the detector signal on the content of components in the studied concentration range was established. Quantitative determination of components was carried out using the absolute calibration method.

When the ratio between the oligomeric components changed, the relative sensitivity coefficient of the detector turned out to be stable, which allows one to judge the applicability of the present approach to the quantitative determination of these components in various reagents.

To confirm the correct identification of fatty acids and their oligomeric derivatives, samples containing only fatty acid monomers and samples containing oligomers were analyzed by gas chromatography with a mass spectrometric detector (GC-MS). Due to the low volatility of fatty acids oligomers, they are not determined by GC-MS; therefore, only monomers were identified in samples in which their presence was also determined by GC, and the results for their quantitative content obtained by both methods were comparable. Quantitative determination was carried out using an internal standard, which was n-hexadecane.

Thus, an on-column gas chromatography method was developed for the quantification of fatty acids oligomers. The results for the content of fatty acid monomers were confirmed by GC-MS. The developed approach is sufficiently accessible for routine determination of the composition of various chemical reagents containing oligomers of fatty acids.

### References

- [1] *Chem. Chem. Tech.* **2021**, 64, 79
- [2] *J. Chromatogr. A* **1989**, 466, 403

# FLOW EXTRACTION DEVICE BASED ON A ROTATING DISK FOR AUTOMATED SAMPLE PREPARATION OF AQUEOUS MEDIUM. DETERMINATION OF POLYCYCLIC AROMATIC HYDROCARBONS IN NATURAL WATERS.

*Dolzhanskaya T.R.<sup>1</sup>, Banerjee T.<sup>2</sup>, Shishov A.Y.<sup>1</sup>*

<sup>1</sup>St. Petersburg State University, St. Petersburg, Russia

<sup>2</sup> Indian Institute of Technology Guwahati, India

[st101519@student.spbu.ru](mailto:st101519@student.spbu.ru)

Environmental monitoring of natural waters is most effective in on-line mode with the shortest time interval from sampling to obtaining analytical information. From this point of view, the actual task of modern analytical chemistry is the development of automated and robotic analytical devices for continuous chemical analysis of natural objects. At the same time, from the point of view of mass analysis it is important to minimize the consumption, or complete abandonment of the use of toxic organic solvents at the stage of sample preparation. As an alternative, a new class of environmentally safe solvents - deep eutectic solvents - has recently been used in analytical practice. This work demonstrates for the first time the analytical capabilities of a new automated sample preparation device with a rotating disk modified with deep eutectic solvents based on natural compounds (natural terpenoids and fatty alcohols). The task of determining the content of polycyclic aromatic hydrocarbons in natural waters was chosen as an analytical problem.

Polycyclic aromatic hydrocarbons (PAHs) are a large group of organic compounds with two or more condensed aromatic rings. Due to the growth of industrial activity, the degree of pollution of environmental objects by PAHs is increasing manifold. One of the main indicators of toxicity of polycyclic aromatic hydrocarbons is their carcinogenicity. In this work, a new device for on-line concentration and determination of PAHs in natural waters was proposed. For this purpose, a flow cell was fabricated by 3D printing method, inside which there was an inert rotating disk, the surface of which was modified with eutectic solvent. PAHs were retained on this disk while rocking a water sample through the device and after elution their concentration was determined by HPLC-FL method. The parameters such as cell topology, hydrodynamic parameters such as sample and eluent flow rates and volumes, the effect of the nature of the disk material and eutectic solvent were studied and optimized. Under optimal conditions, the procedures allowed the simultaneous determination of 10 PAHs with a detection limit of 1 µg/L.

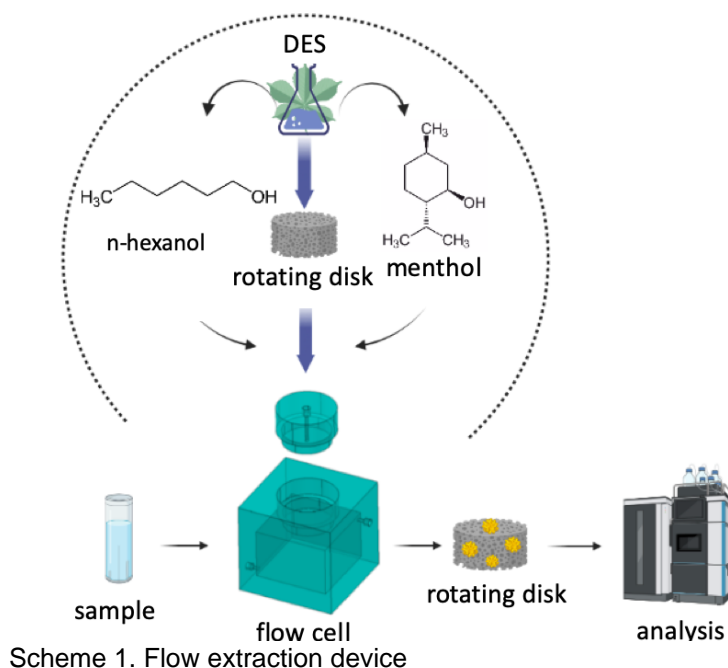

## Acknowledgements

Acknowledgements. This work was supported by the Russian Science Foundation (project No. 24-43-02023). Scientific research was partially performed at the Chemical Analysis and Materials Research Centre of Saint Petersburg State University.

## ALLOYED QUANTUM DOTS: FEW STEPS TOWARDS THE PHOTOLUMINESCENT LABEL PRODUCTION WITH FLEXIBLE PROPERTIES

*Drozdd D.D., Kornilov D.A., Strokin P.D., Goryacheva I. Yu.*

Saratov State University, Saratov, Russia  
Senior Lecturer, Ph.D.

[drozddd@squ.ru](mailto:drozddd@squ.ru)

Photoluminescent semiconductor quantum dots (QDs) are the popular material for a wide range of analytical and labeling applications. But till this moment the most of concepts is not more than a laboratory prototypes [1]. This related to the complex multistage procedure for the synthesis and modification for the most existing QDs types. The key requirement for realizing the advantages of QDs as labels in analytical applications is the development of the set of simple, reproducible, and easily scalable procedures for obtaining QDs with desired properties. In connection with the above requirements, the alloyed CdZnSeS QDs are of particular interest. This type of QDs characterized by a narrow photoluminescence (PL) peak relative to other QDs types due to its structure. The procedure of alloyed CdZnSeS QDs synthesis is one-step and allows controlled production of nanocrystals with PL in almost whole visible spectral region from a single set of reagents by changing the procedure conditions [2-3].

The presented work demonstrates the procedure of PL label production from alloyed CdZnSeS QDs including synthesis, hydrophilization and approbation in a model analytical system. Nanoparticles with PL in the range of 530-620 nm were obtained. The factors influencing the PL peak position were revealed and the possibility of controlled tunability of optical properties was demonstrated. Two types of hydrophilization for QDs are presented: silica-coating and ligand exchange using thiols to provide different functional activities of the surface. A set of simple and effective techniques of hydrophilization by ligand exchange has been developed for alloyed CdZnSeS QDs. Described the non-typical effect of PL enhancement by ligand exchange, characteristic only for this type of QDs, to the best of our knowledge. The fundamental basis of the developed techniques and theoretical reasons of the PL enhancement effect are outlined. The obtained nanoparticles were used in a model medium for the determination of glucose oxidase in homogeneous and heterogeneous analysis formats.

### References

- [1] *Biotechnol. J.* **2020**, *15*, 2000117
- [2] *Chem. Mater.* **2017**, *29*, 7330-7344
- [3] *Appl. Surf. Sci.* **2017**, *415*, 19-23

### Acknowledgements

This work was supported by the Russian Science Foundation (project No 23-13-00380).

## MICELLAR MICROEXTRACTION BASED ON ALKYL POLYGLUCOSIDE FOR THE DETERMINATION OF PHOSPHATES

*Dvoinykh D.D.*<sup>1</sup>, *Kochetkova M.A.*<sup>2</sup>, *Zubakina E.A.*<sup>1</sup>, *Timofeeva I.I.*<sup>2</sup>, *Bulatov A.V.*<sup>2</sup>

<sup>1</sup> St. Petersburg State Chemical and Pharmaceutical University, St. Petersburg, Russia

<sup>2</sup> St. Petersburg State University, St. Petersburg, Russia

Student

[darya.dvojnyh@spcpu.ru](mailto:darya.dvojnyh@spcpu.ru)

When phosphates are used as fertilizers and components of detergents, they become components of wastewater, which leads to disruption of the biocenosis. Recently, phosphates have found wide application in various branches of industry. They are used as moisture-retaining agents, emulsifiers, stabilizers and acidity regulators (food additives E339, E340, E341, E343) [1]. Although these food additives improve the quality of food, their excessive consumption can lead to liver and kidney diseases [2]. Thus, exceeding the maximum residual limits of phosphate ions has an adverse effect on a human body and the environment. In this regard, monitoring the content of this analyte is an important analytical task.

The traditional method of liquid-liquid extraction involves the use of toxic solvents, which does not satisfy the principles of “green” chemistry [3]. As an alternative, alkyl polyglucoside (APG) can be used to form a supramolecular solvent. APGs are naturally nonionic surfactants with low toxicity. In this research micellar microextraction based on using APG have been developed for fast and sensitive determination of phosphates in different samples. The procedure assumes the formation of reduced form of molybdophosphoric heteropolyacid followed by its microextraction into the micellar phase. A carboxylic acid was used as a coacervation agent. The developed procedure was applied for the photometric determination of phosphates in sea, river and well waters and colorimetric smartphone-based determination of phosphates in baby food. The method for the photometric determination provides linear detection range of 0.02–0.40 mg L<sup>-1</sup>, the limit of detection is 0.005 mg L<sup>-1</sup>; for the colorimetric smartphone-based determination the limit of detection is 0.002 mg L<sup>-1</sup>, respectively.

### References

- [1] *Food Compost. Anal.* **2017**, 62, 94-102
- [2] *Kidney Blood Press Res.* **2020**, 45, 802-811
- [3] *Trends in Analytical Chemistry* **2022**, 148, 116530

### Acknowledgements

This work was supported by the Russian Science Foundation (project No 24-23-00052, <https://rscf.ru/project/24-23-00052/>).

# SPECTROPHOTOMETRIC DETERMINATION OF ALUMINIUM IN FOOD SAMPLES USING MADDER'S EXTRACT AND DEEP EUTECTIC SOLVENTS

Fedosov P. A.<sup>1</sup>, Shishov A. Y.<sup>1</sup>, Bochko T. N.<sup>1</sup>

<sup>1</sup>St. Petersburg State University, St. Petersburg, Russia

Student

[petr\\_fedosov@inbox.ru](mailto:petr_fedosov@inbox.ru)

Aluminium is one of the most abundant metal in the world. By mass, 8.8% (88 g/kg) of the earth's crust is aluminum. Nowadays, the problem of enhanced intake of aluminium by human is very actual. Because it leads to different illnesses including Alzheimer's disease[1]. The main source of aluminum intaking by human is food and cosmetics. Higher concentration of Al in food is associated with the use of food additives, containing aluminium compounds, and migration from food contact materials. The content of Al in food is varying from 1,11 mg/kg for beverages and 16,80 mg/kg for vegetables, because of the Al contained in the soils[2]. According to World Health Organization the permissible value of Al intake is 1 mg for 1 kg of human body per day[3]. That's why the determination of aluminium in food is important. There are different methods for the determination of low level of Al<sup>3+</sup> in food such as spectrofluorometry, spectrophotometry, flame atomic absorption spectrometry (FAAS), electrothermal atomic absorption spectrometry (ETAAS), ICP mass spectrometry (ICP-MS) and inductively coupled plasma atomic emission spectrometry (ICPAES). But most of these methods are relatively expensive, difficult in operation and consume hazardous reagents. In the attempt to adopt a greener chemical methodology, many analytical experiments have been explored that make use of green chemicals such as natural reagents that minimize consumption of more hazardous synthetic chemicals. That's why in this work we would determine this metal by spectrophotometry using natural alizarin from extract of madder *Rubia tinctorum*. These roots belong to madder family as historical source of natural red dyes. It contains considerable amounts of the colouring principle 1,2-dihydroxyanthraquinone (alizarin) in the form of its glycoside precursor ruberythric acid, purpurin (1,2,4-trihydroxyanthraquinone) and pseudopurpurin (1,3,4-trihydroxyanthraquinone-2-carboxylic acid)(Figure 1)[4].

The ability of aluminium to form coloured compounds with madder is known from ancient when red pigments were made by precipitation with salts such as alum (KAl(SO<sub>4</sub>)<sub>2</sub> · 12H<sub>2</sub>O). But the structure and mechanism of formation complexes are not yet fully identified.

In this work extraction conditions of alizarin from root were studied, i.e. time extraction, temperature and solvent. The optimal pH range for spectrophotometry determination for forming complex was also studied. It was investigated the influence of deep eutectic solvent (DES) based on menthol/thymol with alcohols and acids on extraction of aluminium complex using spectrophotometry.

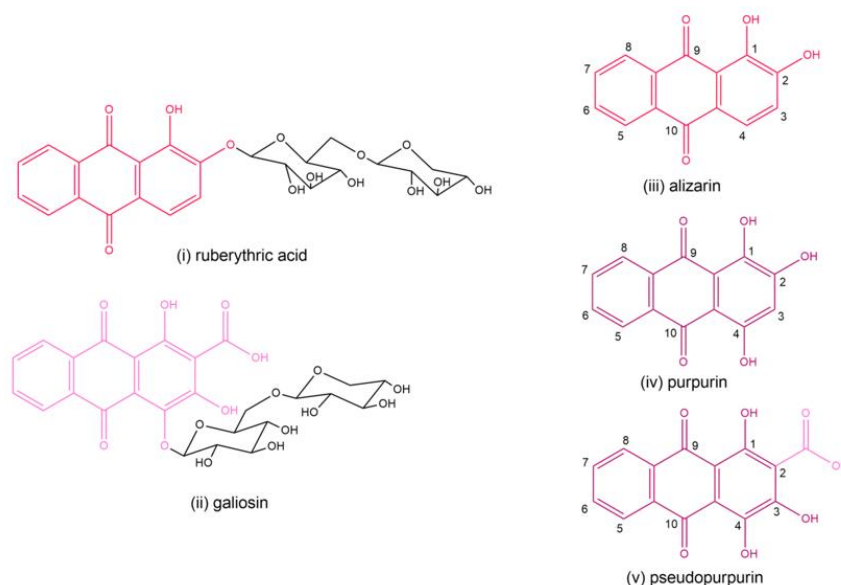

Figure 1. Molecular structures of principal components found in madder roots

## Acknowledgements

This work was supported by the Russian Science Foundation (project No 22-73-10039). Scientific research was performed using the equipment of the Research Park of St. Petersburg State University (Chemical Analysis and Materials Research Centre).

## ASSEMBLABLE MICROFLUIDIC PAPER-BASED DEVICES MODIFIED WITH SILVER NANOPARTICLES FOR COLORIMETRIC DETERMINATION OF BIOFLAVONOIDS

*Furletov A.A.<sup>1</sup>, Yakimenko A.V.<sup>1</sup>, Apyari V.V.<sup>1</sup>, Dmitrienko S.G.<sup>1</sup>, Zolotov Yu.A.<sup>1,2</sup>*

<sup>1</sup> Lomonosov Moscow State University, Department of Chemistry, Moscow, Russia

<sup>2</sup> Kurnakov Institute of General and Inorganic Chemistry, Moscow, Russia

Senior Lecturer, Ph.D.

[aleksei\\_furletov@mail.ru](mailto:aleksei_furletov@mail.ru)

Paper-based microfluidic devices represent a relatively new class of test systems for screening analysis. Their advantages are ease of use and fabrication, low cost, and the ability to visualize the analytical signal without the use of expensive equipment. In such systems, liquid transport through paper from the input zone to the detection zone is carried out by capillary forces. There are various methods for manufacturing paper-based microfluidic devices, such as photolithography, inkjet or wax printing, and cutting out sensors of various configurations. These techniques make it possible to adjust the geometry of microfluidic devices to specific research tasks and also regulate their cost and production time.

Analytical reagents applied to the detection zones of paper-based microfluidic devices play a crucial role in achieving required performance of the determination. Recently, silver nanoparticles have been widely used to enhance the analytical signal in molecular absorption spectroscopy methods. It is worth noting that the optical properties of silver nanoparticles are resulted from the localized surface plasmon resonance phenomenon. In particular, absorption and scattering spectra of silver nanoparticles contain a wide and intense band in the visible region, the position and shape of which strongly depend on the morphology of the nanoparticles and the state of their surface layer.

One of the promising applications of silver nanoparticles is the determination of various biologically active substances, in particular, bioflavonoids. Bioflavonoids are natural heterocyclic antioxidants, which are present in higher plants. Bioflavonoids have a wide range of biological activities and exhibit immunostimulating, antithrombotic, antiallergic, anti-inflammatory and antiviral effects, which makes it important to determine them not only in food products, but also in pharmaceuticals and biologically active food additives.

The purpose of this study was to create assemblable microfluidic paper-based devices modified with silver nanoparticles for colorimetric determination of bioflavonoids.

The microfluidic devices were assembled from prefabricated paper parts on an adhesive substrate of double-sided tape and a polymer plate. The analytical signal was recorded using both the X-Rite i1 Pro2 monitor calibrator and iPhone 12 camera. It is worth noting that, unlike traditional optical color recording devices (such as smartphones, digital photo and video cameras, etc.), the monitor calibrator makes it possible to record the full spectrum of diffuse reflection in the visible region, which significantly increases informativity of the analysis.

An alkaline solution of silver(I) nitrate, spherical silver nanoparticles in the presence of AgNO<sub>3</sub> and silver triangular nanoplates in the presence of AgNO<sub>3</sub> have been proposed as reagents for the detection of bioflavonoids using assemblable microfluidic paper-based devices. The proposed mechanism of interaction includes the reduction of silver(I) nitrate to metallic silver under the influence of bioflavonoids and its deposition on the surface of seed nanoparticles, which leads to their enlargement. The type of nanoparticles effects remarkably on the intensity of the resulting spectral band and the colorimetric response. The observed spectral changes can be used as the basis for methods for solid-phase spectroscopic or colorimetric determination of bioflavonoids.

The conditions for adding spectrophotometric reagents to the detection zone and carrying out the analytical procedure were selected. The analytical characteristics of the determination of quercetin, morin and taxifolin using the developed microfluidic systems were assessed. The detection limits of bioflavonoids, depending on the nature of the substance and method of recording the analytical signal, are 0.1 – 5 µg. The volume of sample sufficient for the analysis does not exceed 20 µL. The approach proposed in this study was used to analyze hawthorn tincture, onion peel and samples of dietary supplements with satisfactory accuracy and reproducibility.

### Acknowledgements

This work was supported by the Russian Science Foundation, project No. 24-73-00061 (<https://rscf.ru/en/project/24-73-00061/>). This research was performed according to the Development program of the Interdisciplinary Scientific and Educational School of Lomonosov Moscow State University «The future of the planet and global environmental change».

## SIMPLE SMARTPHONE BASED DETERMINATION OF CHLORIDES IN OIL USING A TRANSPARENT OPTODE

*Gaga A.S., Serebryakov K.V., Ilyina A.M., Volgina T.N., Gavrilenko M.A.*

National Research Tomsk Polytechnic University, Tomsk, Russia

Postgraduate student

[dce@mail.ru](mailto:dce@mail.ru)

One of the important indicators of the quality of commercial oil is the amount of organochlorine compounds in it. The presence of organochlorine compounds is potentially dangerous for oil refining processes and is detected during the cleaning of technological equipment, pipelines or reservoirs. Currently, for the determination of organochlorine substances and inorganic chlorides, laboratory combined methods of X-ray fluorescence, chromatography and coulometry are used, combining sorption isolation of the components being determined by sorbents of various nature, as well as their determination directly in the solid phase by spectroscopy methods. This approach has shown effectiveness and allowed to increase the selectivity of detection, as well as reduce the detection limit. In addition, the solid-phase spectroscopy method eliminates the use of toxic solvents and ensured the environmental safety of the analysis.

Combining the approaches of optical solid-phase spectroscopy and digital image processing of a colorimetric sensor gave birth to an out-of-laboratory method for monitoring organochlorine compounds. A short contact of the sensor with an oil sample and further image processing on a smartphone allows you to separately determine the amount of inorganic chlorides and the amount of organochlorine compounds after treatment with sodium biphenyl. A simple colorimetric sensor for the chloride anion is proposed, the color change of which is based on the destruction of the colored Hg(II) complex with diphenyl carbazone (DFC-Hg(II)). The essence of the claimed method lies in the fact that the inorganic halides contained in the oil, the content of which corresponds to organochlorine compounds in the initial oil sample, are extracted with a polymethacrylate matrix with immobilized DFC-Hg(II) with a change in sensor color from purple to pink.

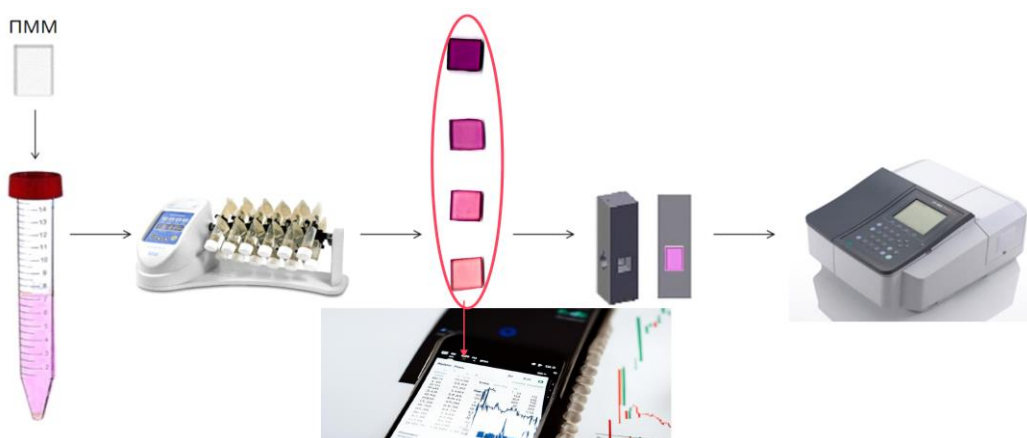

**Scheme 1.** Smartphone based determination of chlorides in oil using a transparent optode

The transparency of the sensor allows the simultaneous use of three methods of signal registration (spectrophotometric, colorimetric and visual), which increases the reliability of the determination. The sensor belongs to the field of "green chemistry", since the mercury cation remains in the polymer volume and does not enter the environment. The solid-phase spectrophotometric technique allows the determination of chloride anions in the range of 0.3 – 60 mg/dm<sup>3</sup> with a detection limit of 0.1 mg/dm<sup>3</sup>. Visual determination is possible with chloride anion content in the range of 3-15 mg/dm<sup>3</sup>. A color image processing algorithm has been developed that calculates the average value of the RGB color coordinates in the selected optode image and converts it to the chloride concentration value. The analytical signal of the colorimetric method of signal registration has a linear region in the range 0.2-30 mg/dm<sup>3</sup>. In comparison with other methods, the modified polymethacrylate matrix is an out-of-laboratory colorimetric system with fast reliable results.

### Acknowledgements

This work was supported by the Russian Science Foundation (project No 24-24-00160).



# DETERMINATION OF PHENYL- AND INDOLE CARBOXYLIC ACIDS BY CAPILLARY ELECTROPHORESIS USING IMIDAZOLE-BASED COVALENT COATINGS

*Ganieva A. Sh., Androsova A.V., Kartsova L.A.*

St. Petersburg State University, St. Petersburg, Russia  
Student

E-mail: [st110520@student.spbu.ru](mailto:st110520@student.spbu.ru)

Metabolism products of tryptophan and catecholamines in the human body – phenyl-, indolecarboxylic acids – are biomarkers of various diseases: pancreatic adenocarcinomas and breast duct carcinomas, neuroblastomas, hypertension, kidney diseases, etc. The concentrations of these analytes in biological fluids are extremely low (~ ng/ ml and µg/ml). For early diagnosis and monitoring of such pathologies, it is necessary to develop highly sensitive, selective and rapid methods for their determination.

Currently, the capillary electrophoresis method is in great demand for this purpose. The use of various modifiers makes it possible to control the selectivity of analytes separation similar structures, and intracapillary preconcentration significantly reduces the limits of their detection. Among the modifiers of different nature, imidazolium ionic liquids are of great interest. The formation of covalent quartz capillary coatings based on the imidazolium cation leads to the reversal of the electroosmotic flow, which allows for rapid analysis of acidic analytes. Additional interactions of analytes with the imidazolium ring (electrostatic, π-π interactions, formation of hydrogen bonds). lead to an increase in the selectivity of their separation.

The purpose of study is to synthesize a covalent coating of quartz capillary walls based on an imidazolium cation and to identify its capabilities for selective separation and online preconcentration of phenyl- and indole carboxylic acids by capillary electrophoresis.

An anodic electroosmotic flux was generated on the resulting covalent coating at pH = 2, which confirmed the formation of a covalent coating, that remained stable during more than 40 analyses (the synthesis scheme is shown in Fig. 1).

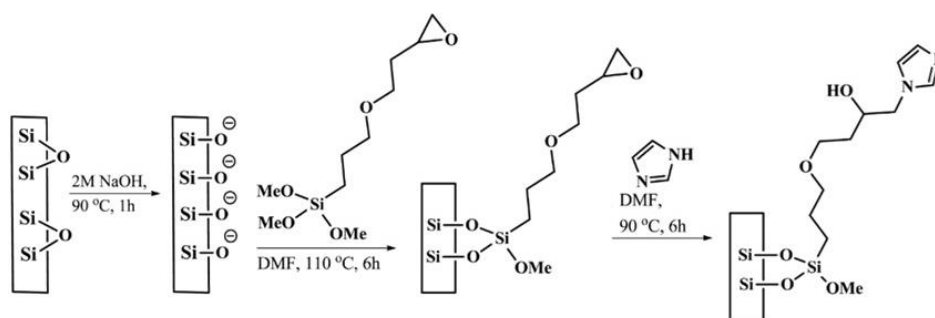

Fig. 1. Scheme of synthesis of a covalent coating based on an imidazolium cation

The conditions (preconcentration concentration and pH of the background electrolyte, nature and volume of the organic additive) for the separation of 10 acids – markers of various diseases – by capillary electrophoresis were found and optimized: 10 mM phosphate buffer solution, pH=4.2 with 10% (by volume) acetonitrile additive. The resolution factors were 1.6 – 5.5, the detection limits ranged from 1.4 to 19 micrograms/ml. To reduce the software, various online concentration options are implemented. The best results were obtained with stacking with a large volume of the injected sample and electrostacking with concentration factors 39 - 77 and 106 – 512, respectively.

## Acknowledgements

The authors express their gratitude to the Resource Centers "Methods for Substance Analysis", "Nanotechnologies" as well as to the Scientific Park of Saint Petersburg State University. The work was carried out with financial support from the Russian Science Foundation (grant No. 24-13-00378).

## QUANTIFICATION OF GLUCOSAMINE AND HYALURONIC ACID IN FOOD SUPPLEMENTS BY POTENTIOMETRIC MULTISENSOR SYSTEM

*Gaponova A.G.<sup>1</sup>, Adels K.<sup>2</sup>, Lang F.<sup>2</sup>, Monakhova J.<sup>2,3</sup>, Kirsanov D.O.<sup>1</sup>*

<sup>1</sup> St. Petersburg State University, St. Petersburg, Russia

<sup>2</sup> University of Applied Sciences, Aachen, Germany

<sup>3</sup> Saratov state university, Saratov, Russia

Student

[097838@student.spbu.ru](mailto:097838@student.spbu.ru)

The widespread use of glucosamine and hyaluronic acid in dietary supplements for the prevention and reduction of knee osteoarthritis-related pain is common nowadays. It has been shown that glucosamine in any form contributes to the treatment of mild to moderate osteoarthritis after six months' use. Hyaluronic acid is also used as a food supplement and in cosmetic products as a moisturising and softening agent, including for joints.

Biologically active supplements are not medicinal products, but they contain active substances such as vitamins, amino acids, minerals, etc. Therefore, an accurate analytical method is needed to control the content of active components in food supplements. Traditionally, the HPLC-UV method has been used for the determination of glucosamine in food supplements [1], but due to low sensitivity and weak UV absorption, the method is often combined with pre- or post-column derivatization [2]. A method using NMR spectroscopy has also been developed [3]. These methods require expensive equipment and are quite resource and time-consuming.

This study focuses on exploring the possibility of using a potentiometric multisensor system as an express and cost-effective method for the quantitative determination of glucosamine and hyaluronic acid in food supplements. Calibration was performed for glucosamine and hyaluronic acid concentrations ranging from  $10^{-3}$  to  $10^{-1}$  M for glucosamine and from  $10^{-4}$  to  $10^{-2}$  M for hyaluronic acid, resulting in a linear relationship between potential and the decimal logarithm of concentration. The responses of the potentiometric sensor system represent a complex chemical fingerprint of the food supplement samples, which can be linked to their composition using multivariate regression modeling methods. The proposed approach was applied to analyze 37 types of food supplements, showing the potential use of multisensor systems for quantitative analysis of glucosamine and hyaluronic acid content with good accuracy, as well as the classification of samples based on active substances.

### References

[1] J. Anal. Chem. **2017**, 72, 879-885

[2] J. Chromatogr. Sci. **2007**, 45, 2, 70-75

[3] Anal. Sci. **2023**, 40, 101-113

# INDICATOR METHOD FOR QUANTATIVE DETERMINATION OF ACID-BASE SITES ON THE SURFACE OF OXIDE MATERIALS

*Gorbunov P.E., Ponomareva A.N.*

<sup>1</sup> St. Petersburg State University, St. Petersburg, Russia  
[pgorbunov276@gmail.com](mailto:pgorbunov276@gmail.com)

In general, active sites on the surface of a solid that have acid-base characteristics are formed by surface chemical structural groups. To obtain the distribution of acid-base groups, the indicator method is used. Unlike liquid systems, assessing the acid-base properties of a solid surface is a more complex task and cannot always be satisfactorily solved using averaged (integral) acidity indicators. Many processes associated with the interaction of solids are local in nature, and the direction and efficiency of these processes strongly depend on the acid-base properties of specific centers on the surface of the material. Therefore, it is important to study the distribution of active centers by type and strength of their acid-base properties, as well as changes in these properties depending on various conditions. [1]

The indicator method is a branch of analytical solid surface chemistry based on adsorption from the liquid phase under static conditions followed by photometric measurement of the amount of adsorbed substance. In this method, the surface of the solid material acts as an adsorbent, and acid-base indicators act as adsorbate probes in the form of indicator molecules. By describing the change in the number of centers during the adsorption process, it is possible to find the optimal composition of the sorbent by examining local maxima of synthesis conditions. This work presents the selection of the calcination temperature of LSLG (large porous silica gel large granular), which ensures maximum sorption capacity for  $\text{Cd}^{2+}$  ions.

From Fig. 1 shows the effective calcination temperature for LSLG when using  $\text{Cd}^{2+}$  as a sorbent. The scheme itself corresponds to theoretical and literary concepts: upon calcination at temperatures above 300 °C, silanol groups transform into siloxane groups. At the same time, calcination at 250 °C makes it possible to modify the surface so as to release pores and thereby increase the surface energy, which leads to a decrease in the potential barrier to the interaction of molecules and ions from the environment. Using the resulting method, it is possible to determine the possible conditions of synthesis and post-processing for the further use of sorbents.

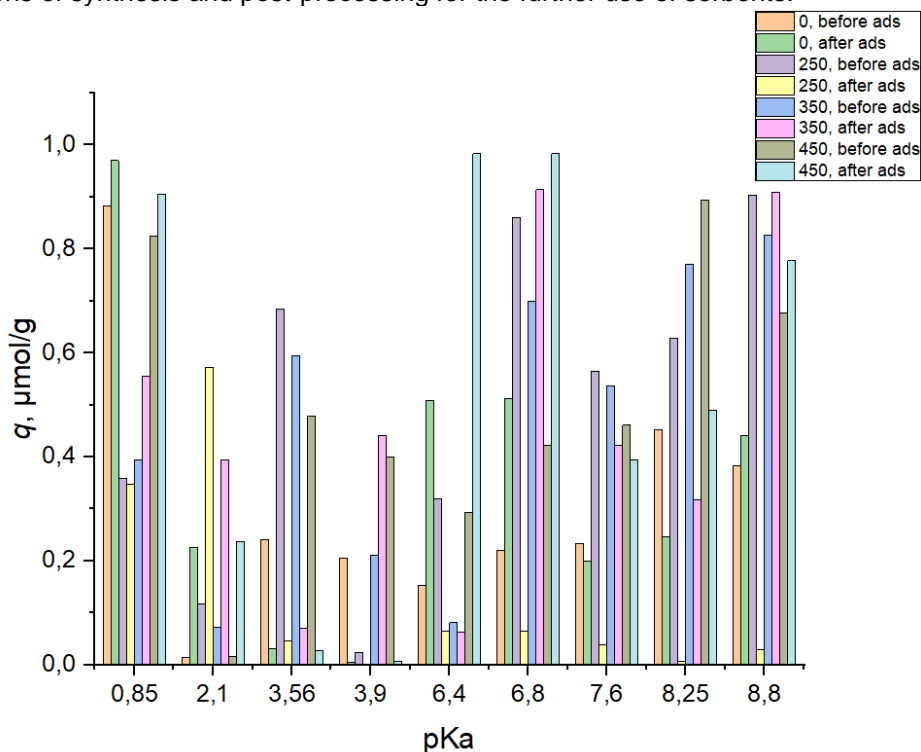

**Figure 1.** Distribution of acid-base sites on the surface of LSLG before and after  $\text{Cd}^{2+}$  adsorption.

## References

[1] *Journal of Separation Science*. **2023**, 46, 2300157.

## MULTI-METHOD SPECTROSCOPIC TRACE ELEMENTAL ANALYSIS OF QUARTZ AND SYNTHESIZED SILICON

*Igosheva V.S.*<sup>1,2</sup>, *Kiseleva D.V.*<sup>1,2</sup>, *Kudyakova V.S.*<sup>3</sup>, *Kel P.V.*<sup>4</sup>, *Fokina A.K.*<sup>2</sup>

<sup>1</sup> Ural federal University, Ekaterinburg, Russia

<sup>2</sup> The Institute of geology and geochemistry, UB RAS, Ekaterinburg, Russia

<sup>3</sup> The Institute of Solid State Chemistry, UB RAS, Ekaterinburg, Russia

<sup>4</sup> The Institute of metallurgy, UB RAS, Ekaterinburg, Russia

PhD Student

[igosheva.v.s@ya.ru](mailto:igosheva.v.s@ya.ru)

To identify the correlation between the initial composition of quartz and synthesized silicon, as well as to develop the technology for producing silicon of solar quality, it is necessary to accurately, correctly and quickly carry out their microelement analysis. The main features of determining the composition of such systems are the low content of trace elements (fractions of ppm) [1] and the high content of the major component (silicon). In this case, the concentration of micro traces is undesirable due to possible sample contamination.

As part of this work, we determined 40 elements in quartz and synthesized silicon. The methods used included inductively coupled plasma mass spectrometry (ICP-MS) (NexION 300S, Perkin Elmer) for the determination of boron, beryllium, rare earth elements, and a number of transition and heavy metals, as well as phosphorus (in cold plasma mode using the molecular ion PO<sup>+</sup>); inductively coupled plasma atomic emission spectrometry (ICP-AES) (Optima 8000, Perkin Elmer) for the determination of boron, phosphorus, iron, aluminum; HR CS ETAAS (ContrAA 700, Analytik Jena) for the determination of boron, phosphorus (by molecular lines), alkali and alkaline earth metals (by atomic lines). Methods for determining boron and phosphorus were compared in sensitivity. It was shown that when taking samples weighing 1.5 g, all methods can be used to control the quality of quartz and silicon (0.3 and 1 ppm for boron and phosphorus, respectively), however, it is advisable to determine lower contents using ICP-MS and ICP-AES.

Sample preparation was carried out in cleanrooms and included preliminary treatment of reagents (double sub-boiling distillation of water and acids) and chemical glassware, acid digestion of samples in a mixture of nitric and hydrofluoric acids, and the preparation of resulting solutions for spectral determination of trace elements. To retain boron in the condensed phase during silicon distillation, we used mannitol.

The mass spectral operating parameters were chosen taking into account the ionization characteristics of the elements, and the indium-115 internal standard characterized the behavior of rare earth elements in plasma. Reducing the plasma power to 600 kilowatts and increasing signal integration to 200 ms made it possible to determine phosphorus by the molecular ion PO<sup>+</sup>. The isobaric interference of <sup>30</sup>SiH<sup>+</sup> on the <sup>31</sup>P<sup>+</sup> atomic ion is more likely than <sup>30</sup>Si<sup>17</sup>O<sup>+</sup> on <sup>31</sup>P<sup>16</sup>O<sup>+</sup>, however, the probability of the formation of molecular ions in the plasma is lower.

The sensitivity of ICP-AES is sufficient to monitor the phosphorus, iron and aluminum content of solar grade quartz and silicon. The selection of conditions for determining phosphorus consisted not only in the choice of operational parameters, but also in the selection of analytical spectral lines, since the most sensitive of them are in the vacuum ultraviolet region.

Using the HR CS ETAAS method, the content of boron and phosphorus was determined from the BF and PO molecules formed in the atomizer, respectively, while the optimized temperature-time program made it possible to increase the service life of the graphite furnace by lowering the atomization temperatures. We also carried out thermodynamic modeling of thermochemical processes in a graphite furnace (HSC 6.1 program), which made it possible to present model systems and determine the parameters and theoretical temperatures of the pyrolysis and atomization stages. Determination of alkali and alkaline earth metals was carried out according to the parameters recommended by the manufacturer and provided low detection limits.

### References

[1] E. Weber. In: Proc. 24th Workshop on Crystalline Silicon Solar Cells & Modules: Materials and Processes, 2014

### Acknowledgements

This work was supported by the Russian Science Foundation (project No 24-29-20264).

## RELATIONSHIP BETWEEN THERMODYNAMIC PARAMETERS AND RETENTION MECHANISM FOR POLAR COMPOUNDS IN HYDROPHILIC INTERACTION LIQUID CHROMATOGRAPHY

*Ivakina K.V., Shemiakina A.O., Chernobrovkina A.V., Spigun O.A.*

Moscow State University, Moscow, Russia

Student

[kseniia.ivakina@chemistry.msu.ru](mailto:kseniia.ivakina@chemistry.msu.ru)

Retention of analytes in hydrophilic interaction liquid chromatography (HILIC) is governed by partitioning, adsorption, and ion exchange mechanisms. The contribution of each one depends on the structure of the stationary phase, the nature of the analyte, and the mobile phase composition. Understanding the processes in chromatographic system is important for successful selecting of separating conditions for complex mixtures. Therefore, evaluation of the retention mechanism is an urgent task in HILIC. In other methods such as reversed phase HPLC or gas chromatography, the determination of the retention mechanism is based on the calculation of thermodynamic parameters using van't Hoff equation. The dependence of the natural logarithm of the retention factor on the inverse temperature is described by the equation [1]:

$$\ln k' = -\frac{\Delta H^{\circ}}{RT} + \frac{\Delta S^{\circ}}{R} + \ln\left(\frac{V_s}{V_m}\right),$$

where  $\Delta H^{\circ}$ ,  $\Delta S^{\circ}$  is the change of standard molar enthalpy and entropy of substance transfer from the mobile to the stationary phase;  $V_s$  is the volume of the stationary phase;  $V_m$  is the volume of the mobile phase. At the moment there is the lack of works aimed at comparing the obtained thermodynamic values with the prevailing retention mechanism in HILIC.

In this work, we determined the thermodynamic retention values for various test compounds (nitrogenous bases, quaternary ammonium salts, sulfonic acids, weak acids and bases) on 3-aminopropyl silica in HILIC mode, varying the column temperature in the range from 25 to 55 °C. The experiments were performed at two eluting ion concentrations of 2.5 and 5 mM for each mobile phase composition: acetonitrile / formate (pH 2.85) or acetate (pH 5.76) buffer solution, 90/10 vol%. The aim of this work was to reveal the effects of mobile phase pH and concentration, and the analyte structure on thermodynamic parameters.

When using formate buffer solution with pH 2.85, amino groups of the stationary phase were fully protonated, so the main contribution to the retention of negatively charged analytes (sulfonic acids) was made by ion exchange. It led to the increase of their retention times with enhancing column temperature. As the concentration of the eluting ion increased, an increase of the enthalpy of transfer was observed due to the decrease of the contribution of electrostatic interactions. Also, the enthalpy was affected by the hydrophobicity of the analyte. Zero enthalpy values were obtained for weak bases, indicating an entropy-controlled process. Negative enthalpy values were estimated for the other substances, indicating exothermicity of the transfer process from the mobile to the stationary phase and a contribution of partitioning and adsorption to retention. Using acetate buffer solution (pH 5.76) led to deprotonation of a part of amino groups of the stationary phase. It resulted in increased retention enthalpy values for most of the analytes. Nonlinearity of temperature dependences was observed for sulfonic acids due to changing retention mechanism with temperature increase.

The different influence of column temperature on the retention times of the analytes resulted in the changes of separation selectivity for the mixture of test substances. Increasing the column efficiency with increasing temperature was also observed. Some critical pairs of compounds were better separated under higher column temperature.

### References

- [1] *Analytica Chimica Acta*. **2015**, 70
- [2] *Food Chem.* **2018**, 248, 70

### Acknowledgements

This work was supported by the Russian Science Foundation (project № 20-13-00140).

# DETERMINATION OF 4-ACETAMIDOPHENYL ACETATE AS PARACETAMOL IMPURITY BY HPLC AND MEKC

*Ivanova S.V.<sup>1</sup>, Nikitina T.G.<sup>1</sup>*

<sup>1</sup>St. Petersburg State Chemical Pharmaceutical University, St. Petersburg, Russia

Student

[sonya.ivanova2204@gmail.com](mailto:sonya.ivanova2204@gmail.com)

Paracetamol (PAA) is widely used as analgesic and antipyretic drug. At present, there are various schemes for the synthesis of PAA, the last stage of which is the acylation of 4-aminophenol. As a side reaction, acylation of the phenolic hydroxyl group is possible, which leads to the formation of 4-acetamidophenyl acetate (AAPA) (scheme 1).

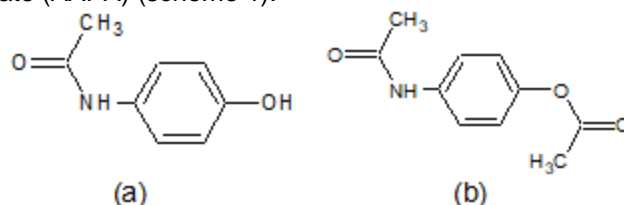

Scheme 1. Structural formulas of paracetamol (a) and 4-acetamidophenyl acetate (b)

According to the requirements of the State Pharmacopoeia of the Russian Federation [1], the determination of related impurities in PAA is carried out by high-performance liquid chromatography (HPLC). The permissible content values are determined only for impurities of 4-aminophenol and chloroacetanilide, the content of other impurities cannot exceed 0.05%, the amount of unidentified impurities is not more than 0.1%. Thus, the existing methodology does not allow to perform the identification and quantification of the content of AAPA in PAA.

The aim of this study was to optimize the conditions for the determination of AAPA by HPLC and micellar electrokinetic chromatography (MEKC).

In preliminary experiments, it was found that PAA and AAPA have similar UV absorption spectra ( $\lambda_{\max} = 240 \text{ nm}$ ). Therefore, HPLC and MEKC detection was performed at a given wavelength. HPLC experiments were carried out on a Shimadzu LC-10 liquid chromatograph (column Luna 5  $\mu\text{m}$  C18(2) 100 A, 4.6 x 250 mm, flow rate 1.0 ml/min, thermostat temperature 40 °C, sample volume 20  $\mu\text{l}$ ). The effect of the composition of the mobile phase on the selectivity and efficiency of the analysis was studied. It was found that the best separation of the peaks of PAA and AAPA is observed at a ratio of acetonitrile and 0.1% phosphoric acid solution of 25:75.

MEKC does not require the use of expensive chromatographic columns and is an alternative method for the determination of organic compounds. The experiments were carried out on a capillary electrophoresis device "Capel-105M" with a quartz capillary (inner diameter 75 microns, outer 365 microns, total capillary length - 60 cm, capillary length to the detector - 50 cm). All analyses were carried out at positive polarity of 20 kV, the sample was injected at 30 mbar for 5 s. The effect of the composition of the working buffer solution (pH and sodium lauryl sulfate content) on the electrophoretic mobility of PAA and impurities was studied. It was found that 0.02 M phosphate buffer solution with pH = 10.6 containing 0.06 M sodium lauryl sulfate is optimal.

METHOD	RETENTION TIME, MIN		N (AAPA)	RS	DETECTION LIMIT, %
	PAA	AAPA			
HPLC	3.63	7.77	9700	14.8	0.01
MEKC	4.43	6.67	25200	7.5	0.1

Table 1. Comparison of analysis characteristics by HPLC and MEKC methods

To increase the sensitivity of the determination of AAPA, the possibility of off-line concentration from PAA solutions with concentrations exceeding its solubility was studied. It was found that the impurity area increases in proportion to the increase in the amount of PAAs. The developed methods of determination were used to control the impurity content of 4-acetamidophenyl acetate in the intermediates of PAA synthesis provided by the Department of Chemical Technology of Medicinal Substances of SPCPU.

### References

[1] State Pharmacopoeia of the Russian Federation. Pharmacopoeia article 2.1.0154.18. Paracetamol.

## DETERMINATION OF OXYGEN IN CERAMICS BASED ON WC, ZrC, Y<sub>2</sub>O<sub>3</sub>

Kaleeva M.A.<sup>1</sup>, Danilov D.A.<sup>1</sup>, Kurlov A.S.<sup>2</sup>

<sup>1</sup> Ural Federal University, Yekaterinburg, Russia

<sup>2</sup> Institute of Solid State Chemistry, UB, RAS, Yekaterinburg, Russia

Student

[derkvoker@yandex.ru](mailto:derkvoker@yandex.ru)

Tungsten carbide (WC) is widely used in industry nowadays. It's one of the strongest compounds after diamond, which also has high density and wear-resistance. Based on these advantages, it's advisable to further research and improve WC ceramic materials. One way to improve the properties of WC products is to produce them from nanocrystalline powders. One of the problems in WC is oxygen. Moreover, the nanocrystal powders have a large specific surface area which relates to increasing oxygen content. If the ceramics are sintered with high oxygen content, there is a phase change from WC to W<sub>2</sub>C with loss of expected properties. Based on this factor it was suggested to add the ZrC+Y<sub>2</sub>O<sub>3</sub> mixture where ZrC binds adsorbed oxygen for converting to zirconia, and Y<sub>2</sub>O<sub>3</sub> dopes it. To control this process, it is necessary to measure oxygen in WC before and after sintering ceramics.

Analysis was carried out using a system for determining oxygen and nitrogen Horiba EMGA-620W/C. Nanosized powders and crushed ceramics were used for measurements. The oxygen content was determined under the following conditions: determination in graphite and nickel capsules at different temperatures including linear and pulse heating modes.

Oxygen is determined by the carrier gas hot extraction method (CGHE): Oxygen from the sample interacts with the carbon from graphite crucible at high temperature melting in an extraction furnace. As the result, CO is released and directed to a non-dispersive infrared detector (NDIR) and the signal is converted into the oxygen content.

Evalograms were obtained from the linear heating analysis for ceramics ZrO<sub>2</sub>+Y<sub>2</sub>O<sub>3</sub> and WC+ZrC+Y<sub>2</sub>O<sub>3</sub>. The following phases were identified using XRD:

1. ZrO<sub>2</sub>+Y<sub>2</sub>O<sub>3</sub> in vacuum+1400 °C: ZrO<sub>2</sub>+Y<sub>2</sub>O<sub>3</sub> – 54% (including tetragonal, Zr<sub>0,84</sub>Y<sub>0,16</sub>O<sub>1,92</sub>, Zr<sub>2</sub>Y<sub>2</sub>O<sub>7</sub>, Zr<sub>0,94</sub>Y<sub>0,06</sub>O<sub>1,88</sub>, Zr<sub>0,79</sub>Y<sub>0,21</sub>O<sub>1,89</sub> phases), ZrO<sub>2</sub> – 42% (including monocline and cubic phases); WO<sub>3</sub> – 1%, Y<sub>2</sub>O<sub>3</sub> – 1%, Y<sub>4</sub>C<sub>7</sub> – 3%, W and ZrWC<sub>4</sub> are less than 1%;
2. ZrO<sub>2</sub>+Y<sub>2</sub>O<sub>3</sub> air+1000 °C: ZrO<sub>2</sub>+Y<sub>2</sub>O<sub>3</sub> – 90% and ZrO<sub>2</sub> – 10%;
3. WC+ZrC+Y<sub>2</sub>O<sub>3</sub>: ZrO<sub>2</sub>+Y<sub>2</sub>O<sub>3</sub> – 3%, WC – 60%, WO<sub>3</sub> – 12%, W<sub>2</sub>C – 4%; W – 21%.

Based on these results, the ZrC+Y<sub>2</sub>O<sub>3</sub> mixture binds oxygen into ZrO<sub>2</sub>+Y<sub>2</sub>O<sub>3</sub>, while the WC phase remains almost unchanged.

Oxygen content by pulse heating mode and by XRD shown in Table 1:

Table 1: Oxygen content results

Ceramic sample	Conditions	Oxygen content, %	Actual oxygen content, %	Oxygen content by XRD, %	Power, kW
ZrO <sub>2</sub> +Y <sub>2</sub> O <sub>3</sub>	Vacuum + 1400 °C	24,4	25,6	25,31	6
	Air + 1000 °C	25,09		25,7	
WC+ZrC+Y <sub>2</sub> O <sub>3</sub>	-	1,5	-	3,26	

The differences in the results of oxygen content determination by CGHE and XRD methods are due to the locality of the latter.

## POLYMER-MODIFIED ELECTRODES FOR THE DETERMINATION OF EUGENOL AND *TRANS*-ANETHOLE IN ESSENTIAL OILS

*Kalmykova A.D., Ziyatdinova G.K.*

Kazan Federal University, Kazan, Russia

PhD student

[alena.kalmykova.pnb.2000@mail.ru](mailto:alena.kalmykova.pnb.2000@mail.ru)

Essential oils are widely used in aromatherapy, food and pharmaceutical industries. They contain a range of electroactive components like eugenol and *trans*-anethole. Eugenol being primary component of clove oil can comprise up to 90% of its composition and is also found in cinnamon and nutmeg oils. *Trans*-anethole is found in large quantities in star anise essential oil. Both eugenol and *trans*-anethole have anti-inflammatory, antibacterial, antifungal, antiviral properties, and exhibit antioxidant activity. Therefore, they are perspective compounds in pharmaceutical industry and their quantification in essential oils is of practical interest.

Novel modified electrodes have been developed for the eugenol and *trans*-anethole voltammetric determination using glassy carbon electrodes with layer-by-layer modification with carbon nanotubes and an electropolymerized coverages based on the phenolic dyes and acids (Fig. 1).

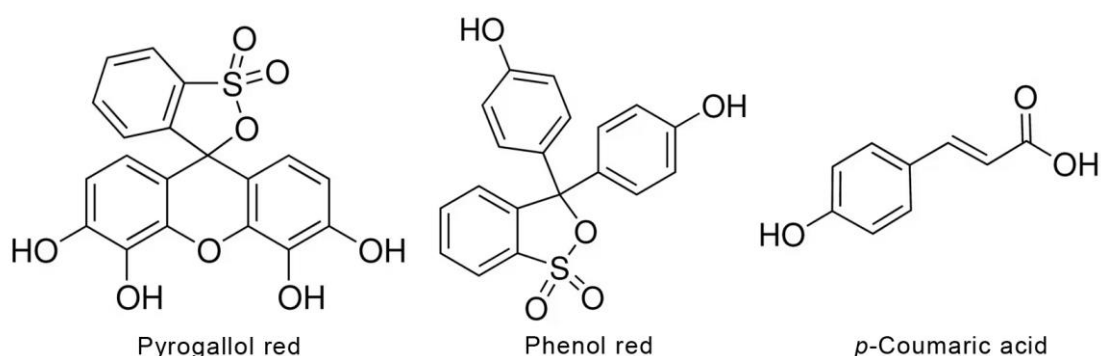

**Figure 1.** Monomers used for the electrode surface modification.

In the case of eugenol, pyrogallol red has been chosen as the monomer. For the *trans*-anethole, a copolymer of phenol red dye and *p*-coumaric acid has been obtained. Carbon nanotubes made it possible to increase the electroactive surface area and conductivity of the electrodes, while polymeric coverages provide high selectivity and sensitivity of the electrode response to target compounds due to the affinity effect.

The working conditions of potentiodynamic electropolymerization (supporting electrolyte, pH, monomers concentration, number of cycles, electrolysis parameters) for the pyrogallol red and phenol red and *p*-coumaric acid combination have been found on the basis of the voltammetric characteristics of eugenol and anethole, respectively. The developed electrodes have been investigated by scanning electron microscopy, voltammetry, and electrochemical impedance spectroscopy. The effectivity of the electrode's modification has been confirmed by significant increase of the electroactive surface area and electron transfer rate. The parameters of electrochemical oxidation of eugenol and *trans*-anethole have been calculated using cyclic voltammetry data at various pH and potential scan rate.

Quantification of eugenol and *trans*-anethole has been performed in differential pulse mode. Adsorptive preconcentration for 120 s at the open circuit potential has been applied in the case of *trans*-anethole as far as its electrooxidation is a surface-controlled process. A linear dynamic ranges of 0.75–100  $\mu\text{M}$  for eugenol and 0.10–7.5 and 7.5–75  $\mu\text{M}$  for *trans*-anethole with detection limits of 0.73 and 0.095  $\mu\text{M}$ . High selectivity of the electrode response towards target analytes has been achieved in the presence of common inorganic and organic compounds, including typical components of the essential oils. The approach has been tested on the commercial essential oils. Validation using an independent method demonstrated similar accuracy and the absence of systematic error in determinations.



# CHOLINE CHLORIDE-BASED DES, IMIDAZOLIUM IONIC LIQUIDS AND POLYDOPAMINE-COATED MAGNETIC NANOPARTICLES AS LIQUID AND SOLID SMART MATERIALS IN ANALYSIS OF NATURAL SAMPLES

*Karpitskiy D.A.*<sup>1</sup>, *Bessonova E.A.*<sup>1</sup>, *Shishov A.Yu.*<sup>1</sup>, *Kartsova L.A.*<sup>1</sup>

<sup>1</sup> St. Petersburg State University, St. Petersburg, Russia

PhD student

[karpitskydmity@gmail.com](mailto:karpitskydmity@gmail.com)

Modern analytical chemistry following the green direction turn to synthesized materials with tuned properties, such as membranes and restricted access materials, MOFs and COFs, various nano-sized materials, ionic liquids (IL) and deep eutectic solvents (DES), surfactants, micellar polymers and some other. Recently, they have been called “smart materials” that means tailored, task-specific, or designed materials, sometimes mimicking the nature, that provide significant enhancement of practical properties [1]. This improvement can be achieved through simplicity, increased selectivity, sensitivity and reduced analysis time. It is also important to effectively extract analytes from such complex matrices as serum, urine, plants and fungi, bacterial lysates, soils, natural waters etc., where analytes are often associated with other matrix components. The properties of deep eutectic solvents and ionic liquids are actively researching, but there is still a lot of white spots. The microextraction properties and selectivity of these phases are taking attention. On the other hand, to solve modern analytical problems, a simple and reliable synthesis of magnetic nanoparticles with the desired selectivity is required. The aim of current work is development of approaches with liquid (DES and IL) and solid (nanoparticles) smart materials for the analysis of real objects.

Deep eutectic solvents, based on choline chloride (CC), and imidazolium ionic liquids were chosen as promising liquid smart materials and tested for microextraction from several plant objects (*I. sibirica* L., *S. baicalensis* L. and other). First tests showed that DES extraction phase is selective for polar compounds, such as glycosides, methylated derivatives of flavonoids. 1-hexyl-3-methylimidazolium ( $C_6MIm$ ) ionic liquids, oppositely, extracted low-polar compounds selectively from water extracts of same plants. Best extractants were chosen - choline chloride-urea, 1:2 mol. (CC-Ur) and 1-hexyl-3-methylimidazolium bis(trifluoromethylsulfonyl)imide ( $C_6MImNTF_2$ ). Conditions for both were optimized using step-by-step approach and designs of experiment. Finally, methods were validated for rutin as DES standard (LOD 0,05  $\mu\text{g/ml}$ ) and thymol as IL standard (LOD 0,021  $\mu\text{g/ml}$ ).

Designed nanoparticles are attractive due to their tunable properties that can effectively absorb the desired compound from complex matrix. Coated magnetic nanoparticles combine easy separation of extraction phase, chemical stability and selectivity to analytes. Polydopamine-coated ferrite nanoparticles ( $Fe_3O_4@PDA$ ) were synthesized and its selectivity to several antibiotics was demonstrated. The co-precipitation and coating stages were optimized for maximum capacity and stability. Using of deep eutectic solvents as eluting solvent allows to reach better EFs than ones obtained for organic solvents. Compatibility for the analysis of several real objects was shown.

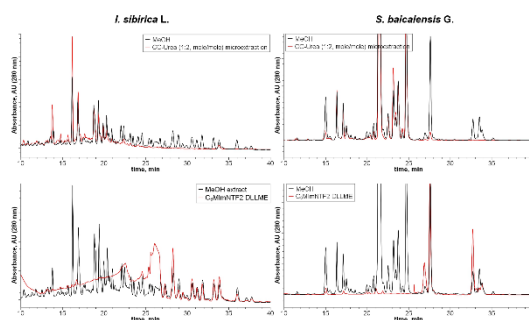

**Figure 1.** Concentration of polar and low-polar compounds in DES and IL phases (comparing with MeOH)

## References

[1] Handbook of Smart Materials in Analytical Chemistry 2019

## Acknowledgements

This work was supported by the Russian Science Foundation (project No 24-13-00378). We express our gratitude to the resource centers “Methods of analysis of compound composition” and “Nanotechnologies and nanomaterials” of Saint Petersburg University Science Park

# PULSE POWER GENERATION CHRONOAMPEROMETRY FOR HIGHLY SENSITIVE GLUCOSE MONITORING

*Kasimovskaya V.S., Eliseev A.A., Karyakin A.A., Komkova M.A.*

Moscow State University, Moscow, Russia

Student

[valeria.kasimovskaya@gmail.com](mailto:valeria.kasimovskaya@gmail.com)

Noninvasive diagnostic protocols allow glucose detection through sweat analysis that excludes skin injury and the risk of infection inherent in blood tests. Noninvasively collected sweat has proved its diagnostic value for hypo/hyperglycemia monitoring, providing positive correlations in metabolite variation rates with blood. The most suitable for noninvasive diagnostic purposes are enzymatic biosensors based on Prussian blue (PB) electrocatalyst because PB-based (bio)sensors are free from poisoning with sweat components and operate at low working potential (0.0 V vs Ag|AgCl), which ensures its selectivity for H<sub>2</sub>O<sub>2</sub> reduction in the presence of other reducing agents. The most efficient way to set working potential is short-circuiting PB-modified electrode with Ag|AgCl reference resulting in nearly noiseless operation [1]. (Bio)sensors described above commonly operate in steady-state chronoamperometry mode with constant shorting the circuit. However, their application for monitoring of biological fluids is limited due to rather low sensitivity and operational stability, which may decrease because of hydrolysis of PB-electrocatalyst by hydroxide-anions generated during enzymatic reaction.

To overcome these challenges pulse power generation readout, providing dramatic improvement of the analytical performance characteristics, is proposed [2]. Unlike steady-state chronoamperometry, when the circuit is permanently shorted and products of the reaction are generated continuously, the pulse regime is realized by periodic opening and shorting the circuit via programmable ammeter. Current registered at fixed sampling time ( $\tau$ ), generated within the short-circuit period, is considered as the (bio)sensor response. Short-circuiting PB-modified electrode with Ag|AgCl reference results in equilibrating the working electrode at 0.0 V vs Ag|AgCl, providing PB reduction to Prussian white (PW). Opening the circuit leads to PW partial transformation to PB accompanied by an open-circuit potential increase. The fraction of reduced and semi-oxidized forms is determined by the period of short-circuiting ( $t_{sc}$ ) and open-circuiting ( $t_{oc}$ ).

To investigate the effect of the pulse profile on the performances of the PB-based H<sub>2</sub>O<sub>2</sub> sensors, calibration graphs at fixed  $t_{sc}$  (2 s), varying  $t_{oc}$  in a wide range from 1 to 20 s and considering different current sampling times from 20 to 2000 ms, were registered. Due to the enrichment of diffusion layer with analyte within open-circuit period the sensitivity grows with a  $t_{oc}$  increase, reaching saturation at  $t_{oc} \approx 15$  s, and is significantly higher at lower current sampling times. In optimal conditions ( $t_{oc} = 15$  s,  $\tau = 20$  ms), the sensitivity of the PB-based sensors exceeds 10 A·M<sup>-1</sup>·cm<sup>-2</sup>, while in the steady-state regime, it is 0.65 A·M<sup>-1</sup>·cm<sup>-2</sup>. Despite increase in background current of PB/PW recharge in pulse mode, sensitivity-to-background ratio is 2.5 times higher than for steady-state regime.

Improvement of analytical performance characteristics in pulse mode is even more pronounced for biosensors since H<sub>2</sub>O<sub>2</sub> is generated during enzymatic reaction within the open-circuit period and accumulates in the diffusion layer. As found, in the pulsed mode sensitivity of glucose biosensors reaches a value of 3.9 A·M<sup>-1</sup>·cm<sup>-2</sup>, which is practically 100 times higher than in conventional steady-state regime. The sensitivity-to-background ratio is increased 15 times, which is 6 times higher than that for the corresponding hydrogen peroxide sensor.

The stability of the biosensor in steady-state and various pulse modes was assessed at a flow rate of 0.5 mL·h<sup>-1</sup> (corresponding to the upper limit of the physiological sweating rates). Even on detecting a high glucose concentration of 0.5 mM, which can hardly be reached in sweat, the sensor response in the pulse power generation regime is absolutely stable within several hours (up to 6 h depending on the pulse regime), while the sensor operated in the conventional mode starts inactivating after 1–1.5 h of monitoring.

## References

- [1] *Analytical Chemistry* **2017**, *89*(12), 6290-6294
- [2] *Analytical Chemistry* **2023**, *95*(19), 7528-7535

## Acknowledgements

This work was supported by the Russian Science Foundation (project No 24-73-10015).

## HYDROPHOBIC ANIONS. EFFECT ON THE EXTRACTION AND SENSITIVITY OF MEMBRANE SENSORS

*Kazanina D.A.<sup>1</sup>, Babain V.A.<sup>1</sup>, Kirsanov D.O.<sup>2</sup>*

<sup>1</sup>V.G. Khlopin Radium Institute, St. Petersburg, Russia

<sup>2</sup>St. Petersburg State University, St. Petersburg, Russia

Engineer of the 2nd category

[Kazanina@khlopin.ru](mailto:Kazanina@khlopin.ru)

One of the promising methods for implementation of online control of chemical composition of spent nuclear fuel (SNF) reprocessing solutions is the use of multisensor systems based on arrays of potentiometric cross-sensitive sensors. Their advantages are resistance to radiolysis, high speed of measurements, wide possibilities for automation and miniaturization, and low cost [1]. Real practical implementation of this approach in the practice of radiochemical production requires the long-term stability of analytical characteristics of multisensor systems. Acidic hydrolysis of chlorinated potassium tetraphenylborate traditionally employed in polymeric membranes as a cation-exchanger is one of the sources of sensor response deterioration. The use of alternative cation-exchanger may improve the long-term sensor response stability. For example, Bis(2-ethylhexyl ether)sulfosuccinate (AOT) seems promising for this purpose. When employed in solvent extraction with tetraoctyldiamide of diglycolic acid [2], AOT sharply increases the distribution ratios of rare earth elements (REE). Using N,O - hybrid donor diamide ligands [3-4] as typical extractants we have first explored the extraction of REEs by mixtures of AOT + N', N'-diethyl-N', N'-(4-methylphenyl)diamide pyridine-2,6-dicarboxylic acid (EtTIDPA) and AOT + tetra-(2-ethylhexyl) diamide of diglycolic acid (T2EHDA) in meta-nitrobenzotrifluoride (F-3) to reveal the synergistic effect (Fig. 1).

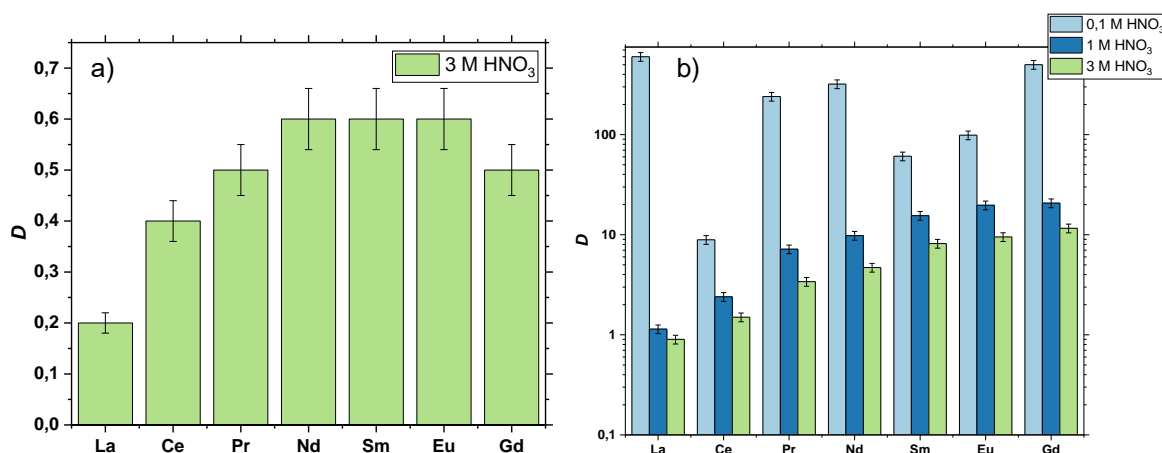

**Figure 1.** Extraction of REEs: a) 0.1 M EtTIDPA in F-3; b) 0.1 M EtTIDPA + 0.01 M AOT in F-3

It can be seen that when added to EtTIDPA, the REE distribution ratios ( $D$ ) increase, however, with an increase in the acidity of the aqueous phase, the synergistic effect weakens. A similar relationship is observed for T2EHDA: when extracting 0.1 M T2EHDA from 0.1 M HNO<sub>3</sub>  $D(\text{Eu}) = 0.8$ , with the addition of AOT – 40. While extraction from 3 M HNO<sub>3</sub> shows an increase in  $D(\text{Eu})$  by only 1.25 times.

At the second stage, the effect of the type of cation exchange additive on the potentiometric response of membrane sensors was studied. For this purpose, a number of membrane compositions based on EtTIDPA/T2EHDA and AOT, as well as a number of other cation exchange compounds, which could be successfully operated under specific conditions of radiochemical production has been studied. The electrochemical sensitivity of the new sensors in solutions of alkaline, alkaline-earth, transition metals, as well as REE was investigated. The results of these works will be presented in the report.

### References

- [1] *Sens. And Act. B.* **2023**, 380, 133315.
- [2] *Sep. Science and Tech.* **2014**, 49(16), 2478-2484.
- [3] *Energies.* **2022**, 15(19), 7380.
- [4] *Sens. And Act. B.* **2008**, 131(1), 29-36.

## INFLUENCE OF THE SPECTRAL INTERFERENCE ON THE DETERMINATION OF PRECIOUS METALS IN BLACK SHALE SAMPLES BY THE ICP-MS METHOD

*Kazin V.I., Zakharchenko E.A., Khludneva A.O., Dogadkin D.N., Gromyak I.N., Tyurin D.A., Kolotov V.P.*

Vernadsky Institute of Geochemistry and Analytical Chemistry of the Russian Academy of Sciences,  
19 Kosygin Str., Moscow, 119991, Russia  
Postgraduate, Junior researcher

[kazin98@list.ru](mailto:kazin98@list.ru)

Black shales are the main rocks processed by the Russian gold mining industry. Analytical support for such deposits discovering, with following their development and processing of ore relate to a number of problems. There is still no reliable method for acid digestion of the large (representative) mass of shale samples. Concentration of noble metals (NM) usually is very low (typically ng/g), and their direct determination is impossible because of a significant systematic error in the results of analysis due to spectral interferences caused by some macro components of the sample.

For example, when a reference sample of SLg-1 black shales is analyzed for Pd, Pt, Rh, the systematic error is more than 1000% due to the formation both polyatomic interferences and interferences caused by double-charged ions. The database of the iPlasmaProQuad program [1] contains more than 100 records of possible interferences for NM determination. It is about 10% of the whole interferences list of the database records. However, the probability of reactions of formation for polyatoms varies noticeably.

We have evaluated the yield of the main interfering reactions while analysis of the black shales. For this purpose, model solutions containing individual interfering elements were prepared. The yields of polyatomic ions were measured for three concentrations of interfering element that differ by an order of magnitude. Some results of the evaluation of the yield of interfering polyatomic ions presented in Table 1.

Table 1. Some examples of polyatomic interference yield

Interference element (isotope)	The yield of polyatomic ions with the mass corresponding to analyte, (as a percentage of the mass of the interfering element)
$^{181}\text{Ta}$	$^{181}\text{Ta}^{16}\text{O} - 8,8\%$ ( $^{197}\text{Au}$ ) $^{181}\text{Ta}^{16}\text{OH} - 3,5\%$ ( $^{198}\text{Pt}$ )
$^{89}\text{Y}$	$^{89}\text{Y}^{16}\text{O} - 6,0\%$ ( $^{105}\text{Pd}$ ) $^{89}\text{Y}^{16}\text{OH} - 1,2\%$ ( $^{106}\text{Pd}$ )
$^{90}\text{Zr}$	$^{90}\text{Zr}^{16}\text{O} - 5,3\%$ ( $^{106}\text{Pd}$ )

Based on the obtained values of the interference yield, the correction coefficients for the determination of some NM in black shales were calculated. It is shown that this approach does not provide results with an acceptable uncertainty, but can be used in some cases only to estimate the concentration of NM. Application just computational version for interference corrections does not result in acceptable results for the most cases.

The general way to eliminate the influence of interference is to carry out the procedure of pre-concentration of NM. For this purpose, the NM preconcentration with sorbents based on nanostructured carbon materials modified with N,S-containing reagents was proposed.

### References

[1] Springer International Publishing, **2023**, 555-562

MODIFIED CARBON NANOMATERIALS FOR CONCENTRATING ULTRA-LOW  
RARE EARTH ELEMENTS CONCENTRATIONS IN GEOLOGICAL SAMPLES

*Khudneva A.O., Kazin V.I., Zakharchenko E.A., Zhilkina A.V., Dogadkin D.N.,  
Tyurin D.A., Kolotov V.P.*

Vernadsky Institute of Geochemistry and Analytical Chemistry, RAS, st. Kosygina 19, Moscow, Russia  
Junior researcher

[717nasta34@gmail.com](mailto:717nasta34@gmail.com)

Determination of rare earth elements (REE) ultra-low concentrations in geological objects is a key analytical task. The most effective method for solving this problem is inductively coupled plasma mass spectrometry (ICP-MS). Geological objects are characterized by a complex matrix compound and high content of macro components, which determines matrix effects when signals recording. Spectral interference is also possible when determining ultra-low REE concentrations. Sorption preconcentration of rare earth elements by selective sorbents makes it possible to eliminate various influences during measurement, reduce detection limits by more than an order of magnitude, and increase the accuracy of analysis results.

Carbon nanomaterials (CNMs) have a large specific surface area and a highly porous structure. The efficiency and selectivity of REE extraction significantly increased by modifying CNMs. Another advantage of carbon nanomaterials is the possibility of their acid decomposition in a microwave oven, which makes it possible to avoid desorption and determine REE directly in the sorbent phase.

To obtain sorbents, mesoporous carbon (MPM) as well as carbon nanotubes (CNTs) were used: CNTs "Taunit" – multilayer, conical in shape and CNTs "G-183" – multilayer, short, cylindrical in shape (TSTU, Tambov). Specific surface according to BET – 90 m<sup>2</sup>/g (Taunit), 270 m<sup>2</sup>/g (G-183) and 3000-3200 m<sup>2</sup>/g for MPM. We carried out carbon nanomaterials modification in two ways. Chemical oxidation significantly increases amount of oxygen-containing functional groups on the surface and ensures the extraction of rare earth elements from low acidic solutions with a pH of at least 2 [1]. The second method is the impregnation of CNMs with the complexing reagent N,N,N',N'-tetraoctyldiglycolamide (TODGA) in 3M HNO<sub>3</sub> or dichloroethane. Such sorbents are stable and used for sorption in acidic environment, which significantly pruned sample preparation and increases the selectivity of REE extraction.

Information about the structure and chemical purity were obtained for the modified sorbents. Their selectivity measured towards to a wide range of elements. Conditions for the group extraction of REE selected and the sorption capacity towards to lanthanum was determined. Additionally, for oxidized sorbents total of functional groups and the ratio of carboxyl groups in them installed, and for sorbents impregnated with TODGA we were determined the ligand content in the solid phase. The most effective sorbents were used for sorption from solutions of ultrabasic rocks standard samples: olivine-rich meymechite - DVM (RIAP; CRM: GSO 4317-88, Russia) and serpentinite - UB-N (ANRT, France). Acid mineralization of samples was carried out in an autoclave complex according to the method [2]. The MARS-5 microwave system was used for sorbents decomposition. Elements in solutions were determined on an X Series II quadrupole mass spectrometer (Thermo Scientific), and the iPlasmaProQuad program [3] was used for data processing.

### References

- [1] Ognev V. E., Khudneva A. O., Zakharchenko E. A. et al. Chemical oxidation and characterization of various types of carbon nanotubes in order to increase the efficiency of concentration of rare earth elements for their subsequent determination in geological samples // *Journal of Analytical Chemistry* . **2023**. T.78. №. 5. C. 405–419.
- [2] V. P. Kolotov, A. V. Zhilkina, V. I. Shirokova et al. A new approach to the mineralization of samples in an open system for the analysis of geological samples by inductively coupled plasma mass spectrometry with improved metrological characteristics. *analytical chemistry*. **2020**. T.75. №. 5. C. 394–407. .
- [3] Kolotov V.P., Zhilkina A.V., Khudneva A.O. iPlasmaProQuad: A Computer System Based on a Relational DBMS for Processing and Monitoring the Results of Routine Analysis by the ICP-MS Method. / *Advances in Geochemistry, Analytical Chemistry, and Planetary Sciences: Special Publication commemorating the 75th Anniversary of the Vernadsky Institute of Geochemistry and Analytical Chemistry of the RAS / Kolotov V.P., Bezaeva N.S. Springer, 2022.*

# DETERMINATION OF ADULTERATION MARKERS USING <sup>1</sup>H NMR SPECTROSCOPY

*Khrolenko R.A<sup>1</sup>, Kupriyanova G.S<sup>1</sup>.*

<sup>1</sup>Baltic Federal University by Immanuel Kant, Kaliningrad, Russia

Student, bachelor

[roma.khrolenko.00@mail.ru](mailto:roma.khrolenko.00@mail.ru)

NMR spectroscopy is one of the most effective methods for analyzing vegetable oils, providing detailed information about both the structure of the molecules and its dynamic properties of the molecules.

This work explores the capabilities of <sup>1</sup>H-NMR spectroscopy to determine the quality of vegetable oils, such as olive, sunflower, avocado, and walnut oils and to identify markers that would allow the identification of oils and the detection of counterfeit products [1-3].

To find markers, relaxation and chemometric <sup>1</sup>H NMR methods were used. Using data on line intensities, iodine numbers were determined for the studied vegetable oils, which made it possible to estimate the degree of unsaturation of fatty acids that make up the fat [2].

Sample name	Iodine number	Iodine number (literature data)
Sesame Oil	126,7	100 - 120
Sunflower Oil	87,6	110 - 145
Turkey Olive Oil	90,5	75 - 94
Borges_2021	72,8	75 - 94
Kamili_olive_oil	74,0	75 - 94
Yudum_olive_oil	71,4	75 - 94
ITLV_refined	72,4	75 - 94
Krakov_olive_oil	73,6	75 - 94
Beldi_olive	74,1	75 - 94
walnut oil	127,7	120-133
avocado oil	109,3	71-95
Linen_oil	175,7	190
Crit_olive	68,5	75 - 94
ondoliva	68,0	75 - 94
Beldi rescans	70,5	75 - 94
Yudum rescans	74,7	75 - 94
Borges_II	71,9	75 - 94

Calculated data on iodine numbers and literature data are given in the table. Analysis shows that iodine value can be used as one of the markers for identifying oils.

Comparison of the data with literature data showed that for a number of samples the iodine numbers are outside the acceptable limits, which may indicate low quality oil. For example, the iodine value for avocado oil is 109, which significantly exceeds the limit value. The oil is likely mixed with oils high in fatty acids, such as walnut oil. It was also found that oil with an expired shelf life also has a lower iodine value, which is associated with oxidative processes in oils leading to degradation of fatty acids.

In addition, analysis of relaxation data made it possible to identify a number of markers based on correlation data T1 /T2.

Table 1. Iodine numbers with literature data.

## References

- [1] Galina Kupriyanova, Mark Smirnov, Ivan Mershev, Ayşe Maraşlı, Cengiz Okay, Georgy Mozzhukhin, Bulat Rameev. Comparative analysis of vegetable oils by <sup>1</sup>H NMR in low and high magnetic fields. *Journal of Food Composition and Analysis*, 126 (2024) 105877
- [2] Ondrej Hendl. Rapid method for determination of iodine numbers of vegetable oils: Master's Theses. – western Michigan University, 1996, 59 pp
- [3] Ruiya Bao, Fenfen Tang, Cameron Rich, Emmanuel Hatzakis. A comparative evaluation of low-field and high-field NMR untargeted analysis: Authentication of virgin coconut oil adulterated with refined coconut oil as a case study. *Analytica Chimica Acta* 1273 (2023) 341537

## DIGITAL IMAGE-BASED TEST SYSTEM FOR ON SITE DETERMINATION OF ASCORBIC ACID IN BABY FOOD

*Kochetkova M.A., Timofeeva I.I., Bulatov A.V.*

St. Petersburg State University, St. Petersburg, Russia

Student

[st068389@student.spbu.ru](mailto:st068389@student.spbu.ru)

Ascorbic acid is a water-soluble compound that is naturally present in food products and is also widely used as a dietary supplement and antioxidant. This substance plays an important role in various biological processes, for example, it promotes the elimination of free radicals, improves iron absorption, normalizes metabolism and increases immunity. However, the excessive consumption of ascorbic acid leads to allergic reactions and gastric irritations [1-2]. Children are especially sensitive to this effect. Therefore, monitoring the content of ascorbic acid in baby food products is an important analytical task.

Most of the existing techniques for the determination of ascorbic acid in food products involve using expensive equipment or time-consuming sample preparation. For *on-site* express simple and cost-effective monitoring of ascorbic acid content in food products, a portable digital image-based system with test stripes have been developed in this work. To perform the analysis test strip with "yellow" form of heteropoly acid is immersed in a sample. Then in the presence of ascorbic acid the heteropoly acid is reduced with formation of a "blue" form. The ascorbic acid content in the sample is determined by the color intensity of the reaction zone of the test strip. For instrumental analysis the image of the test strip is recorded using a smartphone camera and processed in a special application using the RGB color model. Also, the proposed technique allows to evaluate rapidly the concentration of ascorbic acid visually using a color scale. The test system was applied for the determination of ascorbic acid in baby food samples. The limit of detection of the proposed technique is  $3 \text{ mg kg}^{-1}$ , the analysis time does not exceed 5 min.

### References

- [1] *Oral Dis.* **2016**, 22, 463–493
- [2] *Biochim. Biophys. Acta.* **2002**, 1569, 1–9

### Acknowledgements

This work was supported by the Russian Science Foundation (project No 24-13-00118).

## SAMARIUM CUPRATE WITH MICRON-SIZE PORES FOR DRUG SENSING

*Korina E.A.*<sup>1</sup>, *Karaberova A.S.*<sup>1</sup>, *Bulatova E.A.*<sup>1</sup>, *Golovin M.S.*<sup>1</sup>, *Stankovich D.M.*<sup>2,3</sup>, *Gusev S.A.*<sup>4</sup>,  
*Fadeev V.V.*<sup>1</sup>, *Bol'shakov O.I.*<sup>1,5</sup>

<sup>1</sup> Nanotechnology Education and Research Center, South Ural State University, 454080 Chelyabinsk, Russia

<sup>2</sup> University of Belgrade, VINČA Institute of Nuclear Sciences - National Institute of the Republic of Serbia, 11000 Belgrade, Serbia

<sup>3</sup> University of Belgrade – Faculty of Chemistry, 11000 Belgrade, Serbia

<sup>4</sup> Institute for Physics of Microstructures RAS, 603950 Nizhny Novgorod, Russia

<sup>5</sup> Laboratory of Cell Hemostasis, National Medical Research Centre of Cardiology Named after Academician E.I. Chazov of the Ministry of Health of the Russian Federation, 121552 Moscow, Russia  
Senior Researcher, PhD  
[elena.korina@gmail.com](mailto:elena.korina@gmail.com)

Hypertension is a major factor in the development of cardiovascular diseases, such as coronary heart disease and myocardial infarction, and is a cause of cerebral circulatory disorders, including strokes [1]. Enalapril maleate, [(S)-1-[N-[1-(ethoxycarbonyl)-3-phenylpropyl]-L-alanyl]-L-proline] is an effective and safe antihypertensive prodrug [2] that is rapidly absorbed after oral administration. Given its high pharmacological significance, controlling concentration of Enalapril maleate in the human body via urine analysis is necessary for establishing effective treatment of hypertension [1].

A subgroup of rare earth cuprates with a  $K_2NiF_4$  structure has attracted widespread attention as a promising electrocatalyst because of their high electronic conductivity and outstanding electrochemical properties [3]. Samarium derivatives are a class of semiconductors with proven applicability in solar cells, biochemical sensors and nanomagnets [22–24].

Samarium cuprate was tested as a modifier for the carbon-paste electrode in the electrochemical sensing of medically relevant antihypertensive pro-drug Enalapril maleate. Developed sensor has shown promising activity in real samples, low detection limits and significantly wide concentration range of analysis.

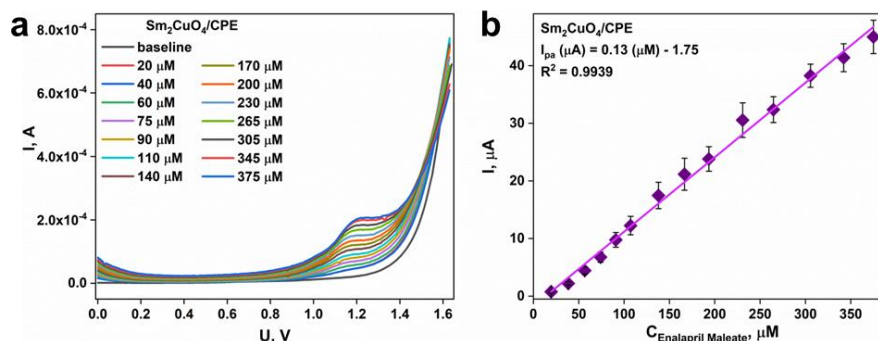

**Scheme 1.** SWV curves of 10 wt%  $Sm_2CuO_4/CPE$  for Enalapril maleate variant concentration in BRBS at pH 6 (a); The linear plot for the Enalapril maleate concentrations versus  $I_{pa}$  (b).

Pristine Samarium cuprate is yet another example of a material with multivalent functionality. With primary application in physics, it was successfully adapted for electrochemical sensing. EC-analysis of drug for hypertension treatment with wide (20–380  $\mu M$ ) detection range and fairly low (6.0  $\mu M$ ) detection limit. Stable chemical structure and chemical resistance provided great reproducibility of results in time and from electrode-to-electrode.

### References

- [1] *J. Anal. Chem.* **2005**, *60*, 436
- [2] *J. Mol. Liq.* **2023**, *386*, 122470
- [3] *J. Alloys Compd.* **2020**, *816*, 152629
- [4] *Int. J. Electrochem. Sci.* **2018**, *13*, 6996
- [5] *Nat. Mater.* **2005**, *4*, 455

### Acknowledgements

This work has been supported with Russian Scientific Foundation Grant № 24-13-20018.



## MAGNETIC SOLID-PHASE EXTRACTION BASED ON MAGNETIC HYPERCROSSLINKED POLYSTYRENE FOR DETERMINATION OF FLUOROQUINOLONES IN MILK WITH HPLC

*Y.A. Kulinich<sup>1</sup>, V.V. Tolmacheva<sup>1</sup>, V.V. Apyari<sup>1</sup>*

<sup>1</sup> Chemistry Department of Lomonosov Moscow State University, Moscow, Russia

Student

[kulinich.yana@gmail.com](mailto:kulinich.yana@gmail.com)

Fluoroquinolones are a group of synthetic broad spectrum antibacterial drugs which are used in veterinary medicine, and there is significant concern about the impact of their residues on human health. For example, the presence of these substances in the environment can cause antibacterial resistance, and food products containing residues of these drugs can be toxic to humans. Therefore, the supervision and monitoring of fluoroquinolone residues have received great attention. In Russia, the Customs Union of the Eurasian Economic Union has approved maximum residue levels (MRLs) for the residues of fluoroquinolones in food products of 0.001–1.5 mg/kg.

The determination of fluoroquinolones in environmental and food samples can be challenging due to their low concentrations and complex composition of analyzed matrices. To overcome this problem, sample preparation is performed to preconcentrate the analytes and remove matrix components. Among the different methods available, sorption methods, which are highly efficient and do not rely on large quantities of toxic organic solvents, appear to be the most favorable option. Magnetic solid-phase extraction is a convenient approach to solid-phase extraction where target analytes are sorbed onto magnetic sorbents that can be easily separated from the sample matrix using an external magnetic field. Compared to traditional solid-phase extraction methods, magnetic solid-phase extraction offers such advantages as speed, cost-effectiveness, and ease of use. It allows for direct extraction of analytes from unpurified samples with suspended solids, eliminating the need for additional centrifugation or filtration steps.

In our work we propose an approach to the determination of fluoroquinolones in milk, based on their sorption isolation and preconcentration on magnetic hypercrosslinked polystyrene. Magnetic hypercrosslinked polystyrene is of great scientific and practical interest, because it combines the unique sorption properties of hypercrosslinked polystyrene with the possibility of separating the sorbent from the solution using a magnet. To achieve the best extraction efficiency, various conditions, such as amount of the adsorbent, pH, extraction time, desorption time and the nature of eluent, were optimized. Under selected conditions, the extraction degrees of fluoroquinolones were in the range of 93–96%. Sample preparation of milk was carried out as follows. At the first stage, direct sorption of analytes from milk on the magnetic hypercrosslinked polystyrene under static conditions was carried out, after that the sorbent was separated from milk using a magnet and washed with water, and then the analytes were eluted from magnetic hypercrosslinked polystyrene with methanol. The results showed that the recoveries of levofloxacin, lomefloxacin, and norfloxacin from milk were in the range of 86–103%.

### **Acknowledgements**

The work was carried out within the framework of the theme under the state order AAAA-A21-121011990021-7 and in the framework of the Development Program of the Interdisciplinary Scientific and Educational School of Moscow University "The Future of the Planet and Global Environmental Changes".

# SUPRAMOLECULAR SOLVENT-BASED MICROEXTRACTION FOR CHROMATOGRAPHIC DETERMINATION OF ENROFLOXACIN IN MILK

*Kurashov Y.V.<sup>1,2</sup>, Pochivalov A.S.<sup>1</sup>, Bulatov A.V.<sup>1</sup>, Garmonov S.Y.<sup>2</sup>*

<sup>1</sup> St. Petersburg State University, Institute of Chemistry, Department of Analytical Chemistry, St. Petersburg, Russia

<sup>2</sup> Kazan National Research Technological University, Institute of Petroleum, Chemistry and Nanotechnologies, Department of Analytical Chemistry, Certification and Quality Management, Kazan, Russia  
postgraduate student  
[yakurashov@outlook.com](mailto:yakurashov@outlook.com)

Liquid-liquid extraction methods are widely used to concentrate and separate analytes from different matrices. However, most of the conventional extraction methods have sufficient drawbacks, for example, high reagents consumption, toxicity of most of the solvents, and prolonged extraction time. Supramolecular solvent-based microextraction methods are being developed in an attempt to address those issues. Primary amines are one of the known precursors for supramolecular solvent formation with the addition of a coacervation agent or environmental change [1]. It is known from the previous work of our group that terpenoids can cause coacervation [2]. Terpenoids such as thymol and menthol are natural components of deep eutectic solvents (DESs), which are multi-component mixtures of hydrogen bond donors and acceptors. In this work, the possibility of supramolecular solvents formation in the presence of primary amines and DESs as coacervation agents was investigated. New extraction systems were applied for microextraction and determination of enrofloxacin in milk.

Hydrophobic DESs were prepared based on terpenoids (thymol and menthol) and primary alcohols and carboxylic acids. All prepared DESs caused phase separation in the primary amine solution. The influence of DES composition and nature of primary amines, molar ratio of precursors, phase volume ratio, extraction time, and sample volume on the extraction efficiency of enrofloxacin were studied. The developed microextraction procedure was coupled with high-performance liquid chromatography with fluorescent detection.

## References

- [1] Vakh C., Koronkiewicz S. Surfactants application in sample preparation techniques: Insights, trends, and perspectives // *Trends in Analytical Chemistry*. – 2023. – V. 165. – P. 117143.  
[2] Bogdanova P., Pochivalov A., Vakh C., Bulatov A. Supramolecular solvents formation in aqueous solutions containing primary amine and monoterpenoid compound: Liquid phase microextraction of sulfonamides // *Talanta*. – 2020. – V. 216. – P. 120992

## Acknowledgements

This work was supported by the Russian Science Foundation (project № 24-13-00118, <https://rscf.ru/project/24-13-00118/>)

## DEVELOPMENT OF ANALYTICAL APPROACHES FOR THE DETERMINATION OF LOW MOLECULAR WEIGHT ORGANIC ACIDS IN BIOLOGICAL FLUIDS

*Lazaretova A.I., Bessonova E.A., Kartsova L.A.*

St. Petersburg State University, St. Petersburg, Russia

Student

[st075497@student.spbu.ru](mailto:st075497@student.spbu.ru)

Low molecular weight organic acids are the most important metabolites involved in the regulation of many biochemical processes in mammals. Dicarboxylic and hydroxycarboxylic acids are formed during the metabolism of amino acids, fats and carbohydrates; short-chain fatty acids (SCFA) are waste products of intestinal microbiota. It has been found that changes in their content in biological fluids can serve as a diagnostic criterion for various metabolic disorders, such as metabolic syndrome, obesity and diabetes, as well as for other diseases, for example, cancer, endometriosis, etc. Thus, it is necessary to control the content of carboxylic acids in biological fluids to deeper understand the relationship between the nature and concentrations of these analytes with specific pathological processes. Since low molecular weight carboxylic acids have higher volatility and hydrophilicity, their determination by traditional methods gas and liquid chromatography requires preliminary derivatization. An alternative approach in the case of highly polar biologically active substances is capillary electrophoresis (CE), which allows the separation of both organic (saturated, dicarboxylic and hydroxycarboxylic acids, amino acids, etc.) and inorganic acids (chloride, bromide, phosphate, sulfate, nitrate, nitrite etc.) in the form of anions in one analytical cycle.

Thus, the aim of the study is to develop sensitive and selective approach for determination of low molecular weight carboxylic acids to obtain characteristic profiles of analytes in biological fluids from patients with various diseases.

The possibilities of determining carboxylic acids both in the form of silyl derivatives and without derivatization were studied using the GC method with mass spectrometric detection. The first approach is traditional in metabolomics, provides low detection limits and the ability to determine amino acids, hydroxycarboxylic and dicarboxylic acids. However, the high volatility of short-chain fatty acids (up to C<sub>4</sub>) challenges current analytical method due to significant losses already at the sample preparation stage that leads to irreproducibility of results. In this study, a fast and reliable method GC-MS without derivatization was developed for the analyses C<sub>2</sub>-C<sub>10</sub> SCFA using polar stationary phase. The workflow for sample preparation of blood serum for GC analysis (precipitation of proteins and purification from lipids) and conditions for the selective separation of analytes (temperature gradient 70-230°C) were developed. The detection limits of organic acids were 0.01-0.1 µg/ml, repeatability (precision and accuracy) and reproducibility were sufficiently accurate for most of the organic acids, making this method suitable for their fast determination in real samples. The application of the developed GC/MS method for the analysis of organic acids in blood serum samples has been evaluated. Characteristic profiles of organic acids (C<sub>2</sub>-C<sub>10</sub>) were obtained in the blood serum of patients with endometriosis and uterine myoma (as a control), followed by chemometric processing to identify potential biomarkers of the disease.

On the other hand, the possibilities of simultaneous determination of organic and inorganic acid anions by capillary zone electrophoresis with indirect detection were studied. Factors affecting the separation performance of analytes have been established: the nature and concentration of the absorbing co-ion (benzoate and chromate) and the background electrolyte (BGE), pH value, and the presence of modifiers in the BGE composition. The conditions for *on-line* preconcentration of analytes (*large volume sample stacking*) were selected, which made it possible to determine acids of various natures in biological fluids. Electrophoretic profiles of organic and inorganic acids were obtained in urine samples of patients with prostate cancer using developed CE approach.

### Acknowledgements

The authors express their gratitude to the Resource Center "Methods for Substance Analysis" of the Scientific Park of Saint Petersburg State University. This work was supported by the Russian Science Foundation (project No 24-13-00378)

## ANALYSIS OF NANOPARTICLES AND NANOMATERIALS BY X-RAY PHOTOELECTRON SPECTROSCOPY (XPS)

*Lazov M.A.<sup>1</sup>, Karygin E.D.<sup>1</sup>, Ischenko A.A.<sup>1</sup>*

<sup>1</sup>MIREA – Russian Technological University (M.V. Lomonosov Institute of Fine Chemical Technologies), Moscow, Russia  
Associate Professor  
[lazovm@gmail.com](mailto:lazovm@gmail.com)

X-ray photoelectron spectroscopy (XPS) or electron spectroscopy for chemical analysis (ESCA) can provide information on the qualitative and quantitative composition, valence states of the elements of the samples under study. XPS provides depth information comparable to the size of nanoparticles and ultrathin films (up to 10 nm depth from the surface) and does not cause significant damage to the samples.

Nanomaterials are materials that have linear dimensions up to 10-100 nanometers. Restrictions in different directions make it possible to divide nanomaterials into zero-, one-, two- and three-dimensional. The chemical composition of the surface and interfaces determine the most properties of nanoparticles and nanostructured materials.

So, analytical depth of the XPS is comparable to characteristic measures (sizes) of nanomaterials. Moreover, XPS doesn't measure signal from the deeper layers of the samples, determining elemental quality and quantity composition and distribution of different oxidation states only in nano-depth layers.

Of course, there are several restrictions and limitations of the method. XPS can determine very thin layers of the sample in vertical dimension, but much more lateral/horizontal areas of the sample (in relation to the depth resolution). While it can get information of upper layers of the sample (for example, layers of nanoparticles), it cannot distinguish the signal of a single particle, only the signal of the whole layer. It means the form and the size of nanoparticle cannot be determined by XPS.

Using electron emission spectra as an analytical signal also leads to the problem of surface charging. Electrons leave the surface of the sample, and the surface becomes charged positively, which makes it hard for the next electrons leave it. This process can be critical for isolators, less harmful for semiconductors and negligible for conducting (metal) samples.

Sample surface properties are hard to predict. Thin films and nanoparticles often show unusual features, not characteristic for the bulk material. It may be unusual oxidation states, conducting properties and everything depending on the electron structure of the particles and layers. It is hard sometimes to find out is it a binding energy shift depending on oxidation state or a surface charging. Some calculated characteristics, like Auger-parameter or Wagner plots, can make clear the state of the sample surface.

New approaches to XPS allow not only to decrease size of the spot from which the information is being collected. They allow get a better resolution using synchrotron X-ray sources or UV-lamps. They also allow measurements at relatively high pressure and in liquid films and jets. They can measure even the separate nanoparticles in the stream (liquid jet).

Although calculation of the surface composition may seem a routine task, it becomes much more complicated in case of non-homogenous distribution of the elements by depth. Similar compositions with different laying order give the spectra with different peak areas and background intensities. It is the task for special modelling programs which create artificial spectra to compare with the collected ones.

So, all the new objects of analysis require new methods and techniques. XPS (ESCA) is not a new method itself, and all the focus now is on the data processing techniques, including background subtraction and deconvolution or peak fitting procedures.

### References

- [1] *Fine Chem. Technol.* **2023**, 18(2), 135

# MICROEXTRACTION OF FLUOROQUINOLONES FROM BIOLOGICAL FLUIDS USING SUPRAMOLECULAR SOLVENTS BASED ON DI-(2-ETHYLHEXYL)-PHOSPHORIC ACID SALT

*Lodianov I.O.<sup>1</sup>, Pochivalov A.S.<sup>1</sup>, Bulatov A.V.<sup>1</sup>*

<sup>1</sup> St. Petersburg State University, Institute of Chemistry, Department of Analytical Chemistry,  
St. Petersburg, Russia  
Student  
[st095115@student.spbu.ru](mailto:st095115@student.spbu.ru)

Fluoroquinolones are broad-spectrum antibacterial drugs that are currently widely used in outpatient and inpatient settings for the treatment of respiratory and urinary tract infections, intestinal and ophthalmic diseases, tuberculosis and many others. They are prevalent in clinical practice due to their pronounced antimicrobial activity and high levels of penetration into tissues and cells of the body. In the context of personalized medicine, the monitoring of the content of fluoroquinolones in biological fluids is required to take into account the individual characteristics of the human body during pharmacotherapy and to increase its safety and effectiveness, thereby reducing the likelihood of serious side effects.

In this study, a supramolecular solvent-based microextraction approach was proposed for the extraction and preconcentration of two fluoroquinolones (ofloxacin and moxifloxacin) from biological fluid followed by their determination by high-performance liquid chromatography with fluorometric detection. Di-(2-ethylhexyl)-phosphoric acid ammonium salt was studied as an amphiphile, and a number of strong electrolytes were studied as coacervation agents inducing aggregation of the micelles. It was revealed that the introduction of di-(2-ethylhexyl)-phosphoric acid and ammonia solution into the sample resulted in the formation of an isotropic solution of anionic surfactant (ammonium di-(2-ethylhexyl)-phosphate). Upon addition of an inorganic salt solution, a supramolecular solvent phase was formed, and the target analytes were extracted into it due to various interactions with the micelles. The performance of the developed approach was demonstrated by the analysis of real biological fluid samples.

## **Acknowledgements**

This work was supported by the Russian Science Foundation (project No 23-73-01266, <https://rscf.ru/project/23-73-01266/>).

## MICROEXTRACTION SEPARATION OF FLUOROQUINOLONE ANTIBIOTICS USING THREE-COMPONENT DEEP EUTECTIC SOLVENTS FOR THEIR DETERMINATION IN SEDIMENT

*K.M. Lusnikova, F.M. Krekhova, A. Yu. Shishov*

Saint Petersburg State University, Saint Petersburg, Russia  
26 Universitetskiy Prospekt  
Student, 2<sup>nd</sup> year

E-mail: [st107278@student.spbu.ru](mailto:st107278@student.spbu.ru)

Fluoroquinolone antibiotics are among the most widely used antibiotics in the fight against microbial diseases. These antibiotics have pronounced bactericidal properties and can suppress the biological activity of a wide range of bacteria. However, the use of antibiotics has a drawback: the production of microbial antibiotic resistance, which makes them immune to certain antibiotics. This can lead to the increase of drug-resistant bacteria in the aquatic environment and pose a potential threat to ecosystems. Therefore, it is essential to develop new methods for detecting traces of antibiotics in bottom sediments for environmental monitoring purposes.

In this study, a method for microextraction of fluoroquinolone antibiotics (ciprofloxacin, moxifloxacin, enrofloxacin, ofloxacin) from sediments using deep eutectic solvent (DES) was proposed. These solvents have found applications in various fields of chemistry, including as efficient and environmentally friendly extractants. Depending on their solubility in water, DES can be divided into hydrophilic, hydrophobic, and quasi-hydrophobic types. Quasi-hydrophobic DES consist of hydrophilic and hydrophobic components that in an aqueous environment decompose with the formation of a new hydrophobic phase. A three-component quasi-hydrophobic DES based on choline chloride, propylene glycol and heptanoic acid was used to the separation and preconcentration of target analytes. After extraction of the target analytes from the sample, the DES was mixed with the aqueous phase, which led to the release of heptanoic acid, into which the analytes were concentrated. The developed method allowed for the efficient extraction of polar analytes from a complex matrix of sediment samples without the need for an additional purification step. The conditions for the microextraction procedure of fluoroquinolone antibiotics for their subsequent analysis by high performance liquid chromatography with fluorometric detection were optimized. The limits of detection, calculated from a blank test based on  $3\sigma$ , were  $1 \mu\text{g kg}^{-1}$  for ciprofloxacin, moxifloxacin, enrofloxacin and ofloxacin.

### **Acknowledgements**

This work was supported by the Russian Science Foundation (project No. 22-73-10039). Scientific research was partially performed at the Chemical Analysis and Materials Research Centre of Saint Petersburg State University.

# METAL-FREE PHOSPHORESCENT MATERIALS FOR OXYGEN SENSING WITH NAPHTHALENE- $\beta$ -CYCLODEXTRIN-HYDROCARBON COMPLEXES

*Makhrov D.E.<sup>1,2</sup>, Ionova I.V.<sup>2</sup>, Ionov D.S.<sup>1,2</sup>*

<sup>1</sup> Moscow Institute of Physics and Technology, Dolgoprudny, Russia

<sup>2</sup> Photochemistry Center, KC "Crystallography and Photonics", Moscow, Russia, Moscow, Russia

Student

[makhrov\\_denis2000@mail.ru](mailto:makhrov_denis2000@mail.ru)

This research focuses on studying the long-lived room-temperature phosphorescence (RTP) characteristics of novel metal-free materials, which were created using a supramolecular approach. These materials contain ternary complexes involving naphthalene (Naph),  $\beta$ -cyclodextrin ( $\beta$ -CD), and three different hydrocarbons: cyclohexane (CyH), toluene (Tol), and p-tert-butyltoluene (p-TBT), which are capable of phosphorescence (Fig. 1).

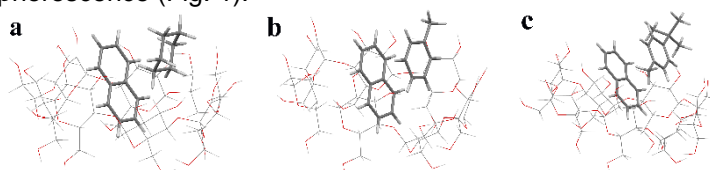

**Figure 1.** The structure of Naph- $\beta$ -CD-CyH (a), Naph- $\beta$ -CD-Tol (b), and Naph- $\beta$ -CD-TBT (c) calculated in the gas phase.

During the study, long-lived RTP with non-monoexponential decays was observed in all examined complexes (Fig. 2a, 2b). The average phosphorescence lifetimes are detailed in Table 1. The weak dependence of RTP decays of these complexes on excitation light intensity and the molar ratio of Naph to  $\beta$ -CD, as well as the observed delayed fluorescence with average lifetime of 1055 ms for the Naph- $\beta$ -CD-CyH complex, indicate the presence of the triplet-triplet annihilation process.

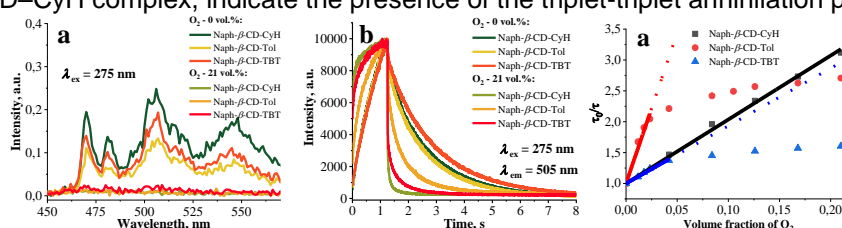

**Figure 2.** (a) The RTP spectra of the Naph- $\beta$ -CD-hydrocarbon complexes; (b) The RTP decay curves of the Naph- $\beta$ -CD-hydrocarbon complexes; (c) The Stern-Volmer plots of RTP lifetimes of the Naph- $\beta$ -CD-hydrocarbon complexes

**Table 1.** The key RTP characteristics of the supramolecular system Naph- $\beta$ -CD-hydrocarbon

Complex	Average RTP lifetime, ms		$K_{sv}$	$k_q, s^{-1}$	LOD, vol. %
	0 vol. % $O_2$	21 vol. % $O_2$			
Naph- $\beta$ -CD-CyH	1803 $\pm$ 3	578 $\pm$ 6	10,4 $\pm$ 0,2	5,7 $\pm$ 0,2	0,002
Naph- $\beta$ -CD-Tol	1164 $\pm$ 7	430 $\pm$ 9	48,8 $\pm$ 2,7	42,1 $\pm$ 3,0	0,001
Naph- $\beta$ -CD-p-TBT	1734 $\pm$ 4	1081 $\pm$ 5	9,3 $\pm$ 0,3	5,4 $\pm$ 0,3	0,002

The effect of  $O_2$  concentration on the intensity and lifetime of complexes RTP was investigated. The key RTP characteristics of the supramolecular Naph- $\beta$ -CD-hydrocarbon systems are presented in Table 1. The RTP lifetimes of the studied materials plotted in Stern-Volmer coordinates are shown in Figure 2c. For the Naph- $\beta$ -CD-CyH complex, the efficiency of RTP quenching remains consistent within the 0–21 vol. % oxygen concentration range. In contrast, for the Naph- $\beta$ -CD-Tol and Naph- $\beta$ -CD-p-TBT complexes, the highest sensitivity to  $O_2$  is observed within the 0–5 vol. % range. However, with further increases in  $O_2$  concentration, the efficiency of quenching decreases, demonstrating a deviation from linearity in the Stern-Volmer coordinates. The nonlinearity of RTP quenching by oxygen for the complexes with Tol and p-TBT, unlike CyH, can probably be explained by the presence of complexes with varying degrees of accessibility to  $O_2$ .

Therefore, the possibility of adjusting the oxygen sensitivity of RTP materials through the manipulation of ternary complex composition, by altering the hydrocarbon component, presents promising opportunities for developing straightforward and effective oxygen sensors capable of detecting a wide range of concentrations.

## Acknowledgements

This work was supported by the Russian Science Foundation (project No 24-13-00443).

# ANALYTICAL CAPABILITIES OF VARIOUS APPROACHES TO ELECTROPHORETIC DETERMINATION OF MONO- AND DISACCHARIDES

*Maliushevskaya A.<sup>1</sup>, Kartsova L. A.<sup>1</sup>*

<sup>1</sup> St. Petersburg State University, St. Petersburg, Russia

PhD student

[malushevskaa@gmail.com](mailto:malushevskaa@gmail.com)

Carbohydrates play a significant role in metabolic processes and their determination in complex biological matrices is applicable for solving diagnostic and food manufacturing problems. Capillary electrophoresis (CE) is an analytical method used for the separation of carbohydrates as well as other analytes with high efficiency, and separation selectivity. Besides, the method provides possibilities for lowering the limit of detection (LOD) for selected analytes using in-capillary sample concentration techniques and intracapillary derivatization. Still, approaches for the electrophoretic detection of carbohydrates aim to overcome the following limitations: absence of chromophore groups, high polarity, and low values of dissociation constants.

Thus, it is possible to determine carbohydrates in the indirect detection mode using the absorbing "probe" ion introduced into the background electrolyte (BGE). The absorbing "probe" selection considers its stability in the BGE, high molar absorptivity, and mobility close to the mobility of analytes to improve separation efficiency. Indirect detection was used for the determination of sugars with the following BGE: 2.5 mM acridoneacetic acid as an absorbing "probe", 75 mM KOH, 0.5 mM cetyltrimethylammonium bromide, and 5% (vol.) methanol. Organic acids and carbohydrates migrated as separate groups of analytes, and the separation of seven carbohydrates was reached. The method was applied for baby food analysis.

Common pre-analysis derivatization methods, which add chromophore group to the carbohydrate molecule, are reductive amination and condensation with 1-phenyl-3-methyl-5-pyrazolone (PMP). Reductive amination was performed using ethyl-p-aminobenzoate (ABEE), and separation conditions for the derivatives were selected. Derivatives were separated in the CZE and the MEKC modes. Sodium dodecyl sulfate (SDS) was introduced into the BGE to form micelles that could enhance the separation of the derivatives through hydrophobic interactions. The MEKC mode was used for the separation due to its higher efficiency and the separation selectivity: the efficiency ranged from 408 to 654 thousand t.p., the selectivity factors were 2.1 – 2.4, and the LOD were 0.75 – 2.93 µg/mL. In-capillary sample preconcentration was performed using sweeping with the addition of micelles into the BGE without their addition into the sample. The sample enhancement factors reached ranged from 13.4 to 19.3. The capabilities of ionic liquids for the separation enhancement were tested as they were introduced into the BGE separately and along with SDS to form mixed micelles.

Derivatization conditions were optimized for analytes separately using the central composite design. Optimal conditions for the derivatization were determined for each analyte using response-surface methodology. Mutual optimization was performed with the desirability function, and experimental yields in the conditions selected complied with the predicted ones. The intracapillary derivatization procedure included the introduction of the sample, the reagent solution, and the BGE zone into the capillary with the following electrophoretic mixing. The SDS micelles were added into the reagent solution to provide its electrophoretic mobility.

Condensation of sugars with PMP was used for the determination of reducing carbohydrates and the derivatives were separated in the CZE mode. The separation efficiency was 200 – 260 thousand t.p., the selectivity factors ranged from 1.0 to 3.4, and LOD was from 0.30 to 0.49 µg/mL. The use of large-volume sample stacking enabled the lowering of LOD to 0.10 – 0.16 µg/mL. Linearity of both derivatization methods was established in the range of concentrations from 10 to 250 µg/mL. Both derivatization methods were adapted to the analysis of baby food.

Therefore, indirect detection and two derivatization methods were used for the electrophoretic determination of carbohydrates. Analytical characteristics of each method were compared and all were applied for the analysis of baby food samples. Besides, the capabilities of in-capillary sample preconcentration and intracapillary derivatization for reductive amination were investigated. The MEKC mode for the reductive amination derivatives demonstrated high efficiency, separation selectivity, and low LOD among the tested ones.

## **Acknowledgements**

This work was supported by the Russian Science Foundation (project No 24-13-00378).



# AN AUTOMATED MICROEXTRACTION PROCEDURE FOR DETERMINATION OF HEAVY METALS IN FOOD PRODUCTS WITH THE USE OF A NOVEL SULFUR-RICH DEEP EUTECTIC SOLVENT

*Markova U.O.<sup>1</sup>, Shishov A.Y.<sup>1</sup>, Bulatov A.V.<sup>1</sup>*

<sup>1</sup>St. Petersburg State University, St. Petersburg, Russia  
Student  
[ulya.markova.01@mail.ru](mailto:ulya.markova.01@mail.ru)

The rapid industrialization alongside contemporary agricultural practices are the main causes of heavy metal contamination of the environment and, consequently, of food products, which are established as the primary source of human exposure to these substances. The impact of metals such as Pb, Cd, and Hg are considered particularly hazardous due to their ability to accumulate in the body, leading to the development of various diseases. The content of heavy metals in food products (depending on the product) should not exceed 0.01-10.0 mg kg<sup>-1</sup> for Pb, 0.003-2.0 mg kg<sup>-1</sup> for Cd, and 0.001-0.1 mg kg<sup>-1</sup> for Hg, respectively [1]. Therefore, the determination of these substances in food products is very important.

Among the multitude of instrumental techniques developed for the determination of heavy metals in food products, inductive coupled plasma-optical emission spectroscopy (ICP-OES) is the most frequently utilized. Despite microwave sample decomposition being the most commonly used sample preparation method, the use of concentrated acidic mixtures often leads to a necessity for dilution of the resulting solution prior to analysis, which is undesirable due to the low concentration of analytes in some food products. To overcome this problem, concentration of analytes from the resulting solution can be used. Considerable attention is currently directed towards extraction approaches, with liquid-liquid extraction (LLE) being the most prevalent method. Nowadays, deep eutectic solvents (DESs) have gained widespread application as «green» extractants. Despite the effectiveness of such solvents for the extraction of organic analytes, only a few studies in the literature have focused on metal extraction.

In this study, an automated microextraction procedure with the use a novel DES based on sulfur-containing compound (thionalide) and natural terpenoid (thymol) as both a chelating agent and an extractant for the determination of heavy metals in food products was developed. The analytical procedure involves the pre-application of the extractant onto a solid-phase carrier, passing through it the aqueous solution of the analytes obtained after microwave sample decomposition followed by their elution and quantitative determination using ICP-OES. Various parameters such as DES composition and the extraction conditions of heavy metals (pH, flow rate, volume of the aqueous solution, solvent for the subsequent elution of the analytes) were studied and optimized. Under these optimal conditions the detection limits for Pb, Cd, and Hg were determined to be 0.01 mg kg<sup>-1</sup>, 0.002 mg kg<sup>-1</sup> and 0.01 mg kg<sup>-1</sup>, respectively.

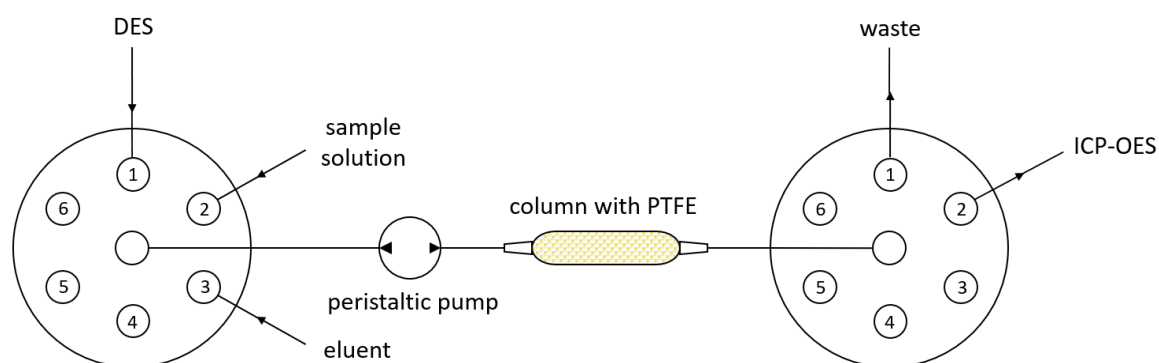

**Scheme 1.** Schematic representation of the developed procedure.

## References

[1] SanPiN. 2.3.2.1078-01. Hygienic requirements to safety and nutritive value of food products.

## Acknowledgements

This work was supported by the Russian Science Foundation (project No 24-43-02023). Scientific research was partially performed at the Chemical Analysis and Materials Research Centre and Thermogravimetric and Calorimetric Research Centre of St. Petersburg State University.

# THE SIMULTANEOUS DETERMINATION OF METHANOL, GLYCEROL, AND WATER IN BIODIESEL USING DEEP EUTECTIC SOLVENTS

*Melesova M.A., Kirsanov D.O., Shishov A.Y., Bulatov A.V.*

St. Petersburg State University, St. Petersburg, Russia

Student

[mariamelesova@gmail.com](mailto:mariamelesova@gmail.com)

**Biodiesel, an alternative fuel, is produced through** catalytic transesterification of vegetable oils or animal fats with alcohol, typically methanol, followed by purification to remove by-products such as glycerol, catalyst residues, and excess alcohol via water washing. However, residual amounts of methanol, glycerol, and water can pose several challenges, including metal corrosion, reduction in fuel flash point, and sediment formation in fuel storage tanks. **According to the European Standard EN 14214**, the maximum permissible concentrations of water, methanol and glycerol are 500 mg/kg, 0.2 % (w/w) and 0.02 % (w/w), respectively. Therefore, there is importance of quality assurance in biodiesel production.

To streamline biodiesel quality control, spectral analysis methods, particularly infrared (IR) spectroscopy offering multicomponent analysis, are prevalent [1]. **The complexity of the biodiesel matrix makes its direct spectral analysis difficult, therefore a sample pretreatment becomes necessary.** The most common method for removing methanol, glycerol and water from biodiesel is liquid-liquid extraction, for which deep eutectic solvents (DES) have been widely used as effective extractants in recent years [2].

**This study aimed to develop a simple, rapid and eco-friendly method for quantifying methanol, glycerol and water in biodiesel using IR spectroscopy combined with microextraction into a deep eutectic solvent.** The proposed analytical approach (Scheme 1) involves adding a hydrophilic deep eutectic solvent, based on choline chloride and urea, to a biodiesel sample. The mixture undergoes vigorous vortex mixing, followed by phase separation. At the next stage, the IR spectrum of the extract is obtained, and quantitative analysis is executed employing a multivariate calibration chemometric model – partial least squares (PLS).

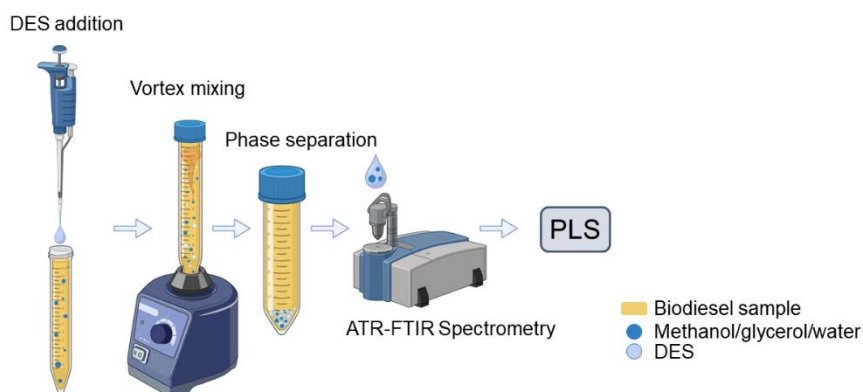

**Scheme 1.** Schematic representation of the developed procedure.

Throughout the investigation, optimal parameters for the extraction process, such as the sample-to-extractant ratio and extraction time, were scrutinized and optimized. Under these optimal conditions, the detection limits for methanol, glycerol and water in biodiesel were determined to be 100 mg/kg, 10 mg/kg and 30 mg/kg, respectively. These values endorse the applicability of the developed method for biodiesel quality assurance, offering advantages like multicomponent analysis, rapidity, simplicity, and environmental benignity.

## References

- [1] *Fuel* **2011**, 90, 2321-2325
- [2] *Analytica Chimica Acta* **2023**, 1277, 341658

## Acknowledgements

This work was supported by the Russian Science Foundation (project No 22-73-10039). Scientific research was partially performed at the Chemical Analysis and Materials Research Centre of Saint Petersburg State University.

# QUASIHIDROPHOBIC DEEP EUTECTIC SOLVENTS: A VERSATILE APPROACH FOR DYES DETERMINATION IN FOOD PRODUCTS

*Muradymov R.R.<sup>1</sup>, Banerjee T.<sup>2</sup>, Shishov A.Y.<sup>1</sup>*

<sup>1</sup> St. Petersburg State University, St. Petersburg, Russia

<sup>2</sup> Indian Institute of Technology Guwahati, India

Student

[St097757@student.spbu.ru](mailto:St097757@student.spbu.ru)

Food dyes allow you to enhance the natural color of a product or give a new and unusual look to a colorless substance. Today, coloring additives are used in many foods. Approval for the use of dyes in the food industry is subject to a wide range of toxicity tests and strict legal regulations in many countries. It is very important to determine the content of permitted dyes in food products, because their excessive consumption can lead to adverse health effects. However, along with the permitted dyes, there are also prohibited dyes, such as Sudan dyes [1], which are often illegally added to food products for deceptive purposes, leading to serious health problems as they are considered carcinogenic [2] and genotoxic.

Most widespread methods for determining dyes in food products often have disadvantages such as labor-intensive sample preparation, low extraction efficiency, and the need to use hazardous organic solvents. Also, a significant limitation in this direction is the fact that there are both water-soluble and water-insoluble dyes. This leads to the need for individual selection of the optimal extractant or mixture thereof for extracting a specific dye. This, in turn, complicates the sample preparation procedure. In the field of food chemical analysis, deep eutectic solvents (DES) have emerged as a promising alternative to traditional organic solvents due to their unique properties, including low toxicity, controlled polarity, and environmental friendliness. DES have found use in the extraction of various classes of both food dyes and prohibited Sudan dyes. However, the possibility of their use for the simultaneous extraction of both polar and non-polar dyes is limited.

This study presents for the first time the possibility of using quasihydrophobic deep eutectic solvents in a new approach for the determination of dyes of different polarities in food products. These DES have a unique composition that includes both polar and non-polar components, allowing for the efficient extraction of a wide range of dyes from complex food matrices. A procedure was developed for the simultaneous extraction of three approved polar dyes (Sunset Yellow FCF, Azorubine, Ponceau 4R) and three non-polar Sudan dyes (Sudan I, Sudan II, Sudan III) in DES followed by HPLC-PDA analysis (Scheme 1). Five DESs were proposed based on polar (water, formic acid, tetrabutylammonium bromide) and non-polar components (thymol, menthol, hexanoic acid, n-hexanol). According to the optimization results, the best extraction was shown by DES based on tetrabutylammonium bromide (TBAB) and hexanoic acid (1:2), which can be explained by the formation of ionic associates between dyes and TBAB; the optimal extraction time was 15 minutes. The proposed procedure was applied to the determination of dyes in different food samples.

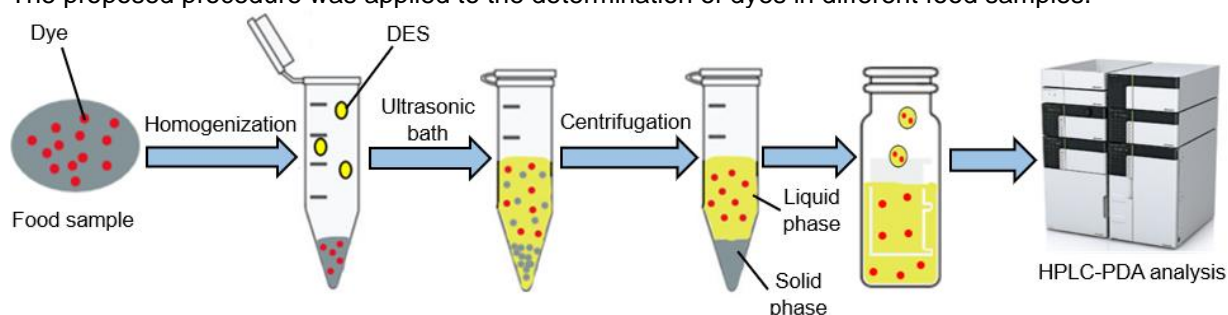

**Scheme 1.** Analysis of solid food products

## References

[1] Official Journal of the European Union. **2005**, 135, 34

[2] IARC monographs on the evaluation of the carcinogenic risk to humans. **1975**, 8, 125

## Acknowledgements

This work was supported by the Russian Science Foundation (project No. 24-43-02023). Scientific research was partially performed at the Chemical Analysis and Materials Research Centre of Saint Petersburg State University.

## SPECTROPHOTOMETRIC DETERMINATION OF CEFTRIAXONE AND CEFOTAXIME IN MILK

*Mursalov R.K., Martynova N.A., Prischeva O.A., Rusanova T.Yu.*

Saratov State University named after N.G. Chernyshevsky, Saratov, Russia

Postgraduate, third year of study

E-mail: [ruslan.mursalov2011@yandex.ru](mailto:ruslan.mursalov2011@yandex.ru)

Milk is one of the main products of the diet, ensuring the full functioning of the human body. The possible presence of antibiotic residues in milk can lead to allergic reactions, changes in the intestinal flora, and bacterial resistance, so this problem is a key one in food safety. Spectrophotometry is a universal method for monitoring the content of drugs in various objects, and promising in the analysis of dairy products in particular. Various variants of chromatographic, electrochemical, and test methods for milk analysis are described in the literature [1-2]. The purpose of this work was to study the possibility of determining ceftriaxone and cefotaxime in milk using the spectrophotometric method.

The object of the study was drinking ultra-pasteurized milk with a mass fraction of fat 3.2% "Belaya Dolina", State Standard-31450-2013, manufacturer: Engels Dairy Plant LLC, Saratov region, Engels, Russia. The sodium salts of ceftriaxone (Ceft) and cefotaxime (Ctox), cephalosporin  $\beta$ -lactam antibiotics ( $\beta$ -lac) (Figure 1), were added artificially to milk, which are widely used in the treatment of various inflammatory processes in medicine and veterinary medicine.

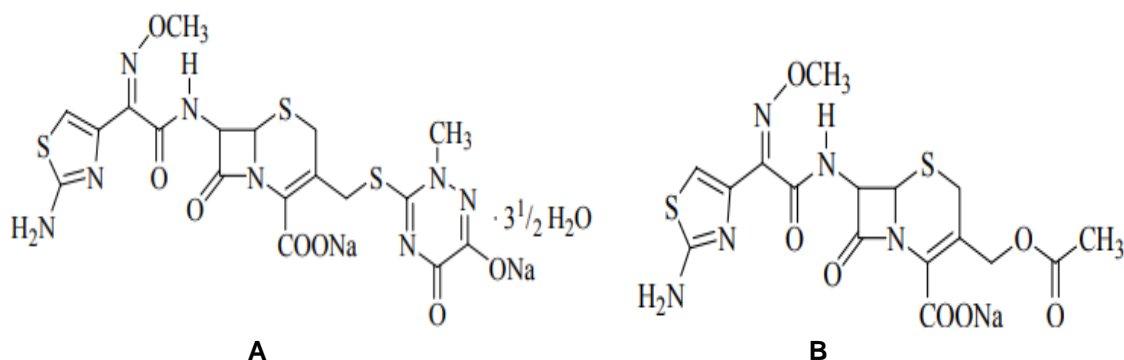

**Fig. 1.** Structural formulas of molecules of sodium salts of ceftriaxone (A) and cefotaxime (B)

The selection of optimal conditions for the process of sample preparation and spectrophotometric determination of the studied antibiotics in milk was carried out. After completing the sample preparation stages, four phases of the system of the object of study were obtained, two liquid phases (aqueous and organic); a dense "tablet" of light beige color; a precipitate in the form of large transparent crystals.

Next, the aqueous solutions of the studied "milk –  $\beta$ -lac" systems were studied. The electronic absorption spectra were recorded using a Shimadzu UV-1800 spectrophotometer in the range of 220-350 nm with a registration step of 1 nm. For the calibration dependences of solutions of pure antibiotics, milk – Ceft and milk – Ctox systems, the correlation coefficients are close to one for the spectrophotometric determination of ceftriaxone and cefotaxime, which gives reason to use the proposed method to determine ceftriaxone and cefotaxime injected into milk. Verification of the correctness of the definition was carried out by the "entered-found" method.

Thus, optimal conditions for milk sample preparation and spectrophotometric determination of ceftriaxone and cefotaxime in it were determined. Electronic absorption spectra of solutions of the studied "milk –  $\beta$ -lac" systems have been obtained. The role of acetonitrile, succinic acid, Trilon B, and ammonium sulfate in the study of systems with the object of study and the additives introduced has been established. The composition of the four phases obtained was previously confirmed by IR spectroscopy.

### References

- [1] J. Anal. Chem. **2018**, 73, 461
- [2] Food Chem. **2015**, 181, 119

### Acknowledgements

This work was supported by the Russian Science Foundation (project No 24-23-00519).

## MODIFIED SCREEN-PRINTED SENSORS FOR THE DETECTION OF CERTAIN CEPHALOSPORIN ANTIBIOTICS

*Mursalov R.K., Kulapina E.G.*

Saratov State University named after N.G. Chernyshevsky, Saratov, Russia

Postgraduate, third year of study

E-mail: [ruslan.mursalov2011@yandex.ru](mailto:ruslan.mursalov2011@yandex.ru)

Cephalosporins differs in pharmacokinetic parameters, in the degree of absorption at different routes of administration, the rate of onset of effect and duration of action, and, consequently, the required frequency of administration of the drug, metabolism and elimination. The cephalosporins studied in this work belong to the II generation (cefuroxime), III – cefotaxime, cefixime; IV – cefepime. Determination of cephalosporin antibiotics in blood serum and plasma is carried out by liquid chromatography with UV detection, mass spectrometry, which requires complex expensive equipment. Rapid detection of antibiotics in biological media is necessary to study the pharmacokinetics of drugs and to select the optimal therapeutic dose. For these purposes, the use of potentiometric sensors is promising.

In this study, planar potentiometric sensors have been developed that are sensitive to cephalosporin antibiotics of various generations. Cefepime, cefixime, cefotaxime are amphoteric antibiotics with carboxyl and aminothiazole groups: they exist as a cation in a strongly acidic medium, a zwitter ion in a slightly acidic or anion in a neutral and alkaline, cefuroxime is an acidic antibiotic. Tetradecylammonium associates with complex compounds silver (I) – beta-lactam; cefepim-tetraphenylborate – cefepime-selective sensors were used as electroactive components. Optimal EAC contents of planar sensors – 2-3%; linearity intervals of electrode functions –  $1 \cdot 10^{-5}$  -  $1 \cdot 10^{-2}$  M, the angular coefficients of  $48 \pm 2$  mV/pC, response time of 20 s for unmodified cefepime-sensors;  $1 \cdot 10^{-4}$  -  $1 \cdot 10^{-2}$  M, the angular coefficients  $28 \pm 3$  mV/pC, response time of 17 s for cefixime-sensors;  $1 \cdot 10^{-5}$  -  $1 \cdot 10^{-2}$  M, the angular coefficients  $46 \pm 6$  mV/pC, response time 30 s for unmodified cefuroxime- and cefotaxime-selective sensors.

The role of modifiers such as polyaniline, ZnO nanoparticles, copper oxides and magnetic nanoparticles in improving the electroanalytical properties of sensors is shown. Nanoparticles promote interaction with antibiotics due to their electronic, chemical, physical properties, as well as a large surface area. The role of polyaniline is associated with the presence of heteroatoms (-NH<sub>2</sub> groups), which improve the electronic conductivity of ink. The introduction of a binary mixture of metal oxides and cetylpyridinium chloride into carbon-containing inks leads to an improvement in the electroanalytical properties of planar sensors sensitive to cephalosporin antibiotics: at the same time, the detection limit is reduced ( $1 \cdot 10^{-5}$  M for cefixime-sensors,  $1 \cdot 10^{-5}$  -  $1 \cdot 10^{-6}$  M for cefepime-, cefotaxime-sensors,  $1 \cdot 10^{-6}$  -  $1 \cdot 10^{-7}$  M for cefuroxime-selective sensors), the angular coefficient increases ( $55 \pm 4$  mV/pC) and the linearity interval of the electrode functions ( $1 \cdot 10^{-6}$  -  $1 \cdot 10^{-2}$  M), the response time is 10-15 seconds. The use of surfactants as a co-modifier of the electrode surface leads to stabilization of the dispersion of nanoparticles.

The use of unmodified and modified screen-printed sensors for the determination of antibiotics in medicines and oral fluid is shown.

# DETERMINATION OF BIOLOGICALLY ACTIVE COMPOUNDS USING A VOLTAMMETRIC SENSOR BASED ON MOLECULARLY IMPRINTED POLY(3,4-ETHYLENEDIOXYTHIOPHENE)

*Nazyrov M.I.<sup>1</sup>, Abdullin Y.R.<sup>1</sup>, Perfilova Y.A.<sup>1</sup>*

<sup>1</sup> Ufa State University of Science and Technology, Ufa, Russia

Graduate Student

[mnazyrov@list.ru](mailto:mnazyrov@list.ru)

The determination of biologically active compounds is an actual problem in the field of analytical chemistry and medicine. One of the effective methods for this purpose is the use of voltammetric sensors based on molecularly imprinted polymers (MIPs). For example, poly(3,4-ethylenedioxythiophene) (PEDOT) is a conductive polymer with unique electrochemical properties such as high specific capacitance, mechanical flexibility, chemical stability, and high conductivity. These features make it an excellent material for creating MIPs. The process of creating template molecules in MIP sensors involves the formation of complexes between the template molecule and monomers, which are then polymerized. After polymerization, the template molecule is removed, leaving pores that are specific to the target molecule. These pores allow MIP sensors to “recognize” and bind target molecules, providing them with high specificity and sensitivity [1].

In this work, we developed a voltammetric sensor based on molecularly imprinted PEDOT for the determination of biologically active compounds. The technology for creating MIP has been tested using the tryptophan (Trp) molecule as a “template” and analyte. Electrodeposition of the PEDOT film was carried out on a glassy carbon electrode (GCE) using cyclic voltammetry in the potential range from 0.0 V to 1.5 V in 10 ml of acetonitrile containing 0.1 M LiClO<sub>4</sub>, 0.001 M EDOT monomer and 0.1 M Trp. It should be added that the polymerization kinetics and film thickness can be controlled by varying the scan rate and the number of polymerization cycles, which makes the method quite flexible in sensor preparation. We chose 100 mV/s and 5 cycles based on the experimental data on the resulting sensors, which showed the best RSD and analyte peak heights. The polymerization curves clearly show a peak at a potential of 1.1 V, which decreases from cycle to cycle until it almost completely disappears (Fig. 1). This indicates that the conductive film loses its electrochemical activity and the sensitivity of the sensor is significantly reduced. In order to compensate its influence on the analytical signal, it was decided to use mesoporous graphitized carbon black Carbopack X (CpX) as a substrate. The morphology of the resulting sensor, its electrochemical and analytical characteristics were studied. The developed sensor showed selectivity towards the selected molecule with a RSD not exceeding 7%. Tryptophan was also determined in the presence of interfering components - in blood plasma and urine. Due to the stability of the resulting surface, it was possible to determine the tryptophan with an RSD not exceeding 10%. In addition, the enantiomers of tryptophan in their mixture were determined, which has important practical applications.

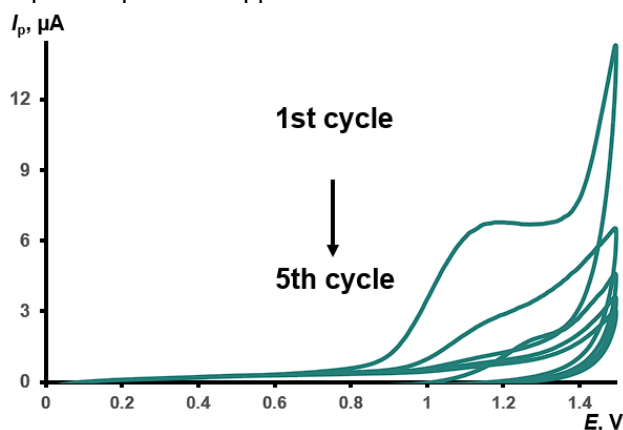

**Figure 1.** Cyclic voltammograms of electropolymerization of PEDOT film.

## References

[1] Yarkaeva Yu.A., Dymova D.A., Nazyrov M.I., Zagitova L.R. Voltammetric sensor based on molecular imprinted polymer for lincomycin detection. *Chim. Tecno Acta*, 2023, V.10, No. 202310210. DOI: 10.15826/chimtech.2023.10.2.10.

## Acknowledgements

This work was supported by the Russian Science Foundation (project No 23-73-00119).

# HPLC-FLD DETERMINATION OF PAHS IN NATURAL WATER SAMPLES USING HYDROPHOBIC DEEP EUTECTIC SOLVENTS

*Nizov E.R.<sup>1</sup>, Shishov A.Y.<sup>1</sup>*

<sup>1</sup> St. Petersburg State University, St. Petersburg, Russia  
Student  
[st076763@student.spbu.ru](mailto:st076763@student.spbu.ru)

Polycyclic aromatic hydrocarbons (PAHs) are a class of organic compounds containing two or more condensed aromatic rings. The European Union and the United States Environmental Protection Agency (US EPA) have listed PAHs as priority pollutants — some compounds of this class are considered carcinogenic to humans, and their ability to accumulate in environmental matrices poses a threat to biota. Understanding the behavior of PAHs when entering various environmental matrices such as water or soil, as well as assessing their concentrations, are important analytical problems today [1-2].

Analytical procedures exist for the determination of PAHs in environmental objects, including sample preparation, which is often impossible under non-laboratory conditions. Moreover, toxic solvents are typically used in such procedures. However, the necessary enrichment factors are not achieved during the sample preparation stage, reducing the sensitivity of the analysis [3]. Currently, there is a trend towards green analytical chemistry, making it relevant to search for new, ecological safe extraction systems for PAHs.

In this study, the use of a hydrophobic deep eutectic solvent (DES) based on menthol and hexanol with extraction cartridges was used. Water samples were pumped at a constant flow rate of 50 ml/min using a hand pump at the sampling site, and then the analytes were desorbed into vials for subsequent determination by HPLC-FLD. This experimental setup allows up to  $10^3$  enrichments of analytes from the aqueous phase without the need to transport large sample volumes to the laboratory. The proposed procedure is rapid (sample preparation takes 20 minutes), accessible, and simple to implement. This approach also involves the use of safe extractants instead of classical organic solvents. During optimization, the following parameters were studied: DES composition, sample volume, eluent volume, and sample flow rate. The developed procedure was successfully tested on real samples of river water. Under optimal conditions, the proposed procedure allows for the determination of PAHs at a level of 10 ng/L.

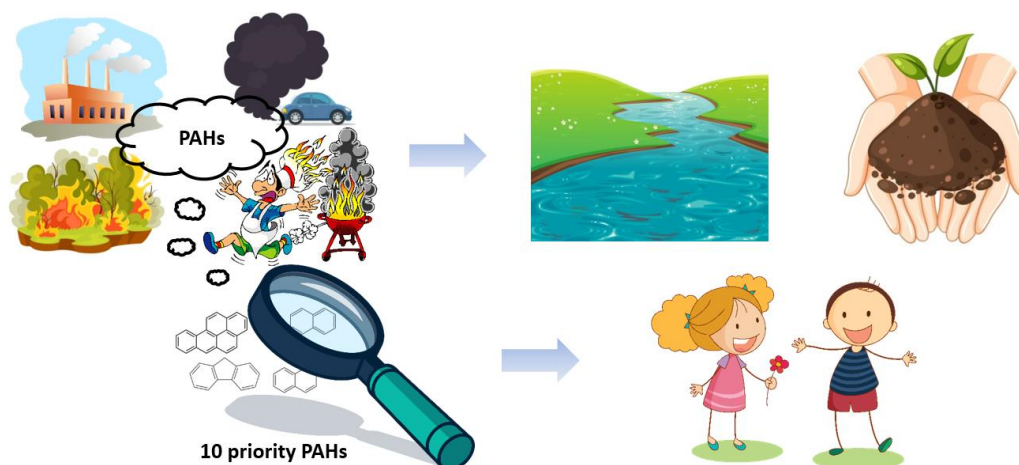

**Figure 1.** Graphical abstract.

## References

- [1] *Environ. Pollut.* **2021**, 290, 117975
- [2] *Chemosphere* **2022**, 296, 133948
- [3] *Trends in Environmental Analytical Chemistry*, **2023**, 37, e00195

## Acknowledgements

The authors gratefully acknowledge the Russian Science Foundation (project no. 22-73-10039). Scientific research was performed using the equipment of the Research Park of St. Petersburg State University (Chemical Analysis and Materials Research Centre).

# ELECTOCHEMICAL SENSOR BASED ON GOLD IDE FOR QUANTITATIVE DETERMINATION OF MIR-371A-3P – BIOMARKER OF TESTICULAR GERM CELL TUMORS

*Pantin A.V.<sup>1</sup>, Navolotskaya D.V.<sup>1</sup>*

<sup>1</sup> St. Petersburg State University, St. Petersburg, Russia  
Student, research assistant  
[andrewpantine@gmail.com](mailto:andrewpantine@gmail.com)

The role of microRNAs in the development of testicular germ cell tumors (TGCTs), the diagnostic potential of these molecules and the possibilities of therapeutic modification of their expression are the subject of numerous fundamental studies [1]. In clinical studies, miR-371a-3p biomarker is used for diagnosis, monitoring the effect of chemotherapy, the quality of lymphodissection and assessing the risk of recurrence. TGCTs is a relatively rare pathology, the social significance of which is determined by the age of patients: the maximum relative incidence is observed in the age group of 25-29 years. Since molecules of this cluster circulating in blood plasma, in particular miR-371a-3p molecules, are promising markers of TGCTs, preliminary assessment of changes in their expression level in tumor tissue compared to the expression level in unaltered testicular tissue seems to be an important step in the development of new approaches to liquid biopsy [2].

Sensors obtained by stepwise surface modification of gold interdigitated electrodes (IDEs) using electrochemical detection techniques are promising tools for diagnostics. detection techniques are promising tools for diagnosing various diseases at early stages.

The proposed gold-based IDE electrochemical sensors, through modification with an oligonucleotide trap and self-organizing monolayer, become selective to a specific analyte oligonucleotide, a biomarker of testicular germ cell tumors. Qualitative and quantitative characteristics of the proposed sensors were established using electrochemical methods of analysis – cyclic voltammetry, electrochemical impedance spectroscopy and alternating current voltammetry.

In the course of the work, the optimal parameters for modification of gold IDEs were selected, which made it possible to achieve the analyte detection limit up to 0.83 fM. The dependence of the analytical signal on the logarithm of the concentration of the analyzed oligonucleotide was linear over the entire concentration range from 83 nM to 0.83 fM. In addition, the analytical characteristics obtained on different types of gold IDEs were compared.

## References

- [1] Regouc, Manuel, et al. "Non-coding microRNAs as novel potential tumor markers in testicular cancer." *Cancers* 12.3 (2020): 749.
- [2] Dieckmann, Klaus-Peter, et al. "Serum levels of MicroRNA-371a-3p (M371) can predict absence or presence of vital disease in residual masses after chemotherapy of metastatic seminoma." *Frontiers in Oncology* 12 (2022): 889624.



# SELF-ASSEMBLY OF SILVER NANOPARTICLES AT THE LIQUID-LIQUID INTERFACE AS SCAFFOLD FOR NEW GENERATION OF RAMAN SENSORS

*Pavlova A.A.,<sup>1</sup> Shekhovtsova A.D.,<sup>2</sup> Maleeva K.A.,<sup>3</sup> Smirnov E.A.<sup>1</sup>*

<sup>1</sup> Infochemistry Scientific Center, ITMO University, Saint-Petersburg, Russia

<sup>2</sup> State Budgetary Educational Institution Lyceum № 211 named after Pierre de Coubertin, Saint-Petersburg, Russia

<sup>3</sup> International Research and Educational Center for Physics of Nanostructures, ITMO University, Birzhevaya Liniya, 14, St. Pe-tersburg, Russia  
Student

[pavlova@infochemistry.itmo.ru](mailto:pavlova@infochemistry.itmo.ru)

Soft interfaces, such as liquid-liquid interfaces, offer a versatile platform to self-assemble nanoparticles and fabricate ordered nanofilms for diverse applications like sensors, transparent and conductive films, *etc.* [1] Since the discovery of metallic flexible films by Yogevev and Efrima in their work in 1988 [2], many attempts have been made to improve the synthesis procedure and investigate the properties of such films. Recent studies have focused on the formation of metal liquid-like droplets, opening new avenues for research [1,3].

In this work, we present a straightforward approach to the self-assembly of silver nanoparticles (AgNPs) without surface functionalizing or covalent linkers. Self-assembly occurs due to tetrathiafulvalene (TTF) molecules in the organic phase placed in the contact with AgNPs synthesized by the Leopold-Lendl method [4] under vigorous stirring in an emulsion, resulting in the formation of a continuous silver film. Notably, the resulting AgNP assemblies exhibit self-healing properties after re-dispersion.

Characterization of the colloidal solutions via UV-Vis spectroscopy and dynamic light scattering reveals nanoparticles with an average diameter ranging from 66 to 84 nm, exhibiting stability with zeta potential values not exceeding -25 mV. Subsequently, the AgNP assemblies are transferred to silicon substrates for utilization in Raman spectroscopy as enhancing surfaces. Atomic force microscopy (AFM) analysis confirms the close-packing of nanoparticles, ensuring uniformity across the film.

Initial investigations into enhancing properties, utilizing malachite green dye, demonstrate an enhancement factor of  $10^4$ . Benchmarking using previously published protocols, [5,6] including Raman mapping of substrates, further underscores the efficacy of the prepared substrates. Finally, the superior substrates are employed for the detection of polyphenolic compounds, such as chlorogenic acid (CGA), caffeic acid (CA) and quinic acid (QA), demonstrating their versatility and sensitivity with minimal limits of detection (LOD).

In summary, our study presents a robust method for fabricating enhancing substrates via the self-assembly of AgNPs at liquid-liquid interfaces. These substrates exhibit exceptional characteristics, including high enhancement factors and low limits of detection, promising broad applicability across various fields.

## References

- [1] *Chem. Rev.* **2018**, *118*, 3722-3751
- [2] *J. Phys. Chem.* **1988**, *92*, 5754–5760
- [3] *ACS Nano* **2014**, *8*, 9471–9481
- [4] *J. Phys. Chem. B* **2003**, *107*, 5723-5727
- [5] *Sensors*, 2023, **2023**, *23*, 6352
- [6] *ACS Sensors*, **2024** (submitted)

## Acknowledgements

This work was supported by the Russian Science Foundation (project No 22-73-00206).

# MICELLE-MEDIATED EXTRACTION OF GLYPHOSATE FROM FOOD SAMPLES FOLLOWED BY ITS DERIVATIZATION, ENRICHMENT AND LIQUID CHROMATOGRAPHIC DETERMINATION

*Pavlova K.V., Pochivalov A.S., Bulatov A.V.*

St. Petersburg State University, St. Petersburg, Russia

Student

[st067859@student.spbu.ru](mailto:st067859@student.spbu.ru)

Herbicides are widely used agrochemicals to control weeds in gardens and fields. Glyphosate is one of the most popular non-selective herbicides in the world. It can be applied several times during the growth and maturation of the cultivated crops. This herbicide has a detrimental effect on the environment as it heavily pollutes soils and adjacent water bodies. Foods such as fruits, berries, vegetables, cereals and legumes are usually contaminated with it. Glyphosate is very dangerous to human health and can cause inflammatory bowel disease, cancer and metabolic disorders. Due to the toxic effect on humans health, maximum residue limits of this herbicide in products of plant origin are established in the Russian Federation (for example, 20 mg/kg for cereal grains and 0.3 mg/kg for potatoes).

In this work, an approach for micelle-mediated extraction of glyphosate from a solid food sample into a solution of a biodegradable nonionic surfactant (alkyl polyglucoside) and subsequent derivatization of the analyte with the reagent 9-fluorenylmethylchloroformate in an alkaline medium was proposed. Preconcentration of the fluorescent derivative was carried out by the addition of a fatty acid as coacervation agent, which induced supramolecular solvent formation and phase separation. The extracts were then analyzed by high performance liquid chromatography with fluorometric detection.

During the study, conditions for the chromatographic determination of the analyte derivative were found as well as extraction and derivatization parameters were optimized. The present approach was studied for the determination of glyphosate in different food matrices to demonstrate its analytical capabilities.

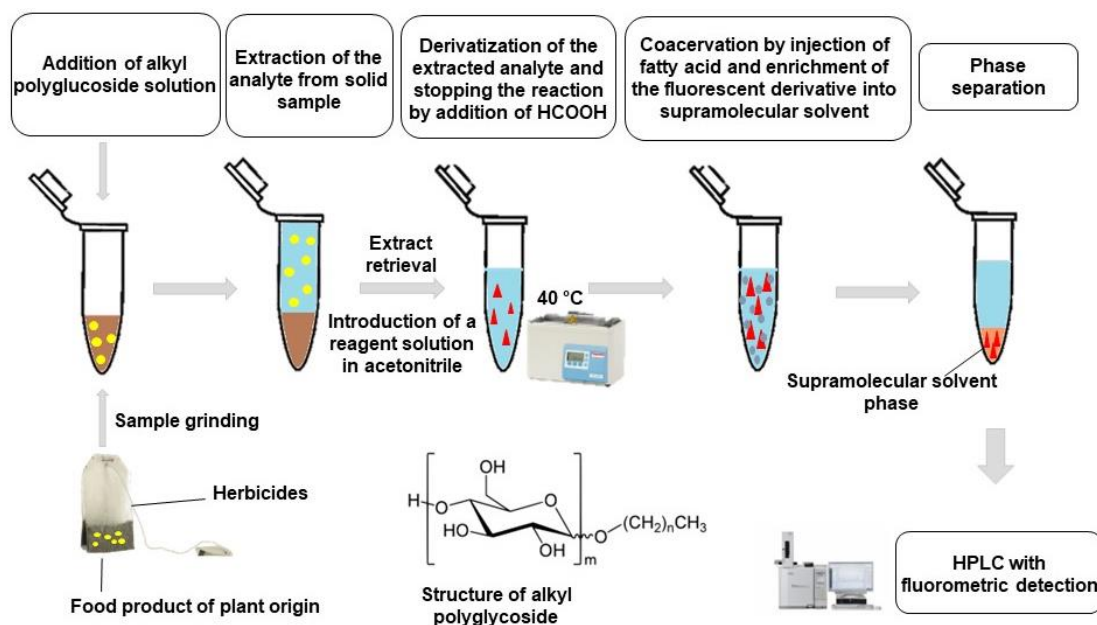

**Figure 1.** Schematic representation of sample preparation steps.

## Acknowledgements

This work was supported by the Russian Science Foundation (project № 24-13-00118, <https://rscf.ru/project/24-13-00118/>).

## DUMMY TEMPLATE IMPRINTED PROTEINS FOR ZEARELENONE DETERMINATION IN GRAINS

*Pidenko P.S.<sup>1</sup>, Pidenko S.A.<sup>1</sup>, Burmistrova N.A.<sup>1</sup>*

<sup>1</sup> Saratov State University, Saratov, Russia  
Researcher, PhD  
[pidenkops@gmail.com](mailto:pidenkops@gmail.com)

One of the key problems of modern agricultural production is the violation of storage regulations of grain crops. This leads to their contamination with a number of ecotoxicants, including mycotoxins. Aflatoxins, for example zearalenone, exhibit high toxicity to poultry (e.g. *Gallus gallus*). The climatic conditions change has led to significant contamination of grain crops with zearalenone in Saratov region. This requires the development of low cost methods for in field determination of zearalenone using synthetic receptors.

The most promising format for such test systems is pseudo-ELISA. One of the most common receptors for pseudo-ELISA are different types of molecular imprinted polymers [1]. Imprinted proteins (IPs) are of particular interest among the large number of methods for performing molecular imprinted polymers, IPs are biosynthetic receptors, which are characterized by low cytotoxicity and labor cost of synthesis, and the availability of reagents. Currently, IP has been successfully used to determination of low (aflatoxin B1, zearalenone, vomitoxin, kwakhurin) and high (ovalbumin, bacterial lipopolysaccharides) molecular weight compounds by pseudo-ELISA protocol [2]. However, a native antigen was used as a template in all known investigations. At the same time, the use of dummy templates instead of toxic or few available templates is well-known approach in molecular imprinting technique.

In this work, the influence of the template on the analytical characteristics of the pseudo-ELISA based on IPs was studied. Bovine serum albumin and glucose oxidase were chosen as matrix molecules, zearalenone and its dummy templates (coumarin derivatives) - as templates. A comparison of the analytical characteristics of the obtained IPs for determination of zearalenone in wheat extract was carried out.

### References

- [1] *Anal. Chim. Acta* **2018**, *1040*, 99-104
- [2] *Biotechnol. Rep.* **2016**, *11*, 12-17

### Acknowledgements

This work was supported by the Russian Science Foundation (project No 22–16–00102).

# ELECTROCHEMICAL LACTATE BIOSENSORS BASED ON CHITOSAN MEMBRANE FOR CONTINUOUS ANALYSIS

*Pleshakov V.M., Nikitina V.N., Karyakin A.A.*

Moscow State University, Moscow, Russia  
Student

[vladislav.pleshakov@chemistry.msu.ru](mailto:vladislav.pleshakov@chemistry.msu.ru)

Detection of lactate is an important analytical task in the fields of medical diagnostics and biochemistry. This compound is produced by organisms during anaerobic glucose oxidation, so abnormal concentrations of lactate in biological fluids can be used to detect several diseases, e.g., cancer. Suggested sensors are first-generation electrochemical biosensors, which are based on enzymatic oxidation of lactate and consequential electrochemical reduction of hydrogen peroxide on the electrode [1]. High selectivity of hydrogen peroxide detection is achieved with modification of electrode surface with electrocatalysts. One of them, Prussian blue, was used in this work.

Immobilization of lactate oxidase can be achieved with different polymers, including chitosan and siloxane. For this work we used biopolymer chitosan. Immobilization was conducted with drop casting of water solution, containing the enzyme and the polymer on Prussian blue modified screen-printed electrode. In flow injection amperometry mode maximal sensitivity of  $346 \pm 71 \text{ mA} \cdot \text{M}^{-1} \cdot \text{cm}^{-2}$  is achieved in a range from 0.05 to 0.1% of chitosan in the casting mixture. Linear range of prepared biosensors is  $1 \cdot 10^{-6}$ – $1 \cdot 10^{-4}$  M and they retain 90% of the initial current response on 1 mM lactate solution for 30 minutes. However, their stability is insufficient for continuous monitoring of lactate in biological fluids, so methods of stabilization were proposed.

We have shown that stability of the biosensors can be enhanced with use of nickel hexacyanoferrate additional layer prepared as described in [2]. Modified biosensors retain 90% of the response for almost 3 hours, but their sensitivity is decreased to  $85 \pm 7 \text{ mA} \cdot \text{M}^{-1} \cdot \text{cm}^{-2}$ . These results indicate that, in addition to enzyme inactivation or washing out from the membrane, the electrocatalyst contributes to low stability of the biosensors.

Another approach for biosensor stabilization is based on the additional perfluorsulphonated ionomer (PFSI) coating on the chitosan membrane. Drop casting of 0.2% solution of this polymer results in increase of stability up to 1.5 hours, but also in decrease of sensitivity to  $97 \pm 22 \text{ mA} \cdot \text{M}^{-1} \cdot \text{cm}^{-2}$ . Increasing polymer concentration leads to further improvement of stability of the biosensors up to 9 hours. It is important to note that in case of additional membrane linear calibration range of the biosensor depends on PFSI concentration, as shown in scheme 1. This effect can be used to adjust biosensor applicability to different matrices, especially undiluted biological liquids, e.g., blood.

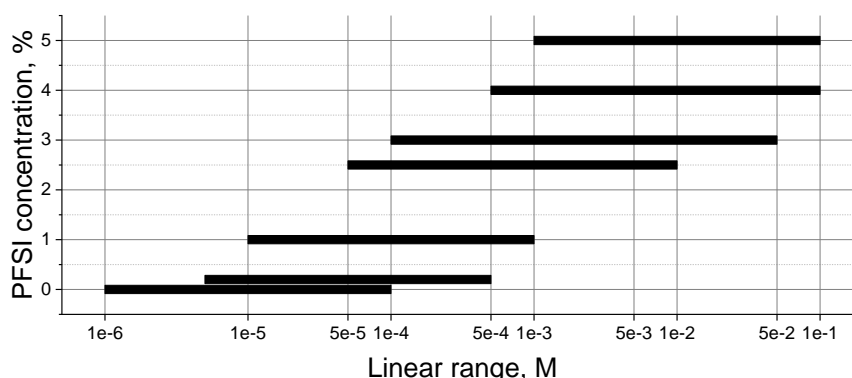

**Scheme 1.** Linear range dependence on PFSI concentration in additional membrane-forming solution.

Thus, we have found the optimal chitosan concentration of 0.05% for lactate biosensors and have proposed modifying agents either for electrocatalyst or enzyme-containing polymer membrane to achieve sufficient stability for continuous analysis.

## References

- [1] *Analytical Chemistry*. **2022**, 94, 25, 9201-9207
- [2] *RSC Advances*. **2016**, 6, 105, 103328-103331

## Acknowledgements

This work was supported by the Russian Science Foundation (project No 24-13-00049).

# WATER-SOLUBLE ACIDOCHROMIC DYES LIPOPHILIZED WITH QUATERNARY AMMONIUM CATIONS AS TUNABLE HYDROGEN CHROMOIONOPHORES FOR POLYMERIC OPTICAL SENSORS

*Prozherin I.S., Pokhvishcheva N.V., Menshova A.S., Peshkova M.A.*

St. Petersburg State University, St. Petersburg, Russia  
Student

[IlijaProzherin@yandex.ru](mailto:IlijaProzherin@yandex.ru)

At present, there is a wide variety of classes of polymeric optical sensors in research practice, among which colorimetric optodes are the most commonly used due to the ease of signal acquisition and response interpretation. Their response mechanism is based on the establishment of heterogeneous equilibria with the participation of an optically detectable component (hydrogen chromoionophore), the protonated and deprotonated forms of which have contrasting colours. Nowadays, hydrogen chromoionophores are mainly derivatives of acid-base indicators lipophilized by introducing long-chain radicals [1]. However, this method of lipophilization can be cumbersome due to the complex structure of the parent compounds and intricacy of the product purification [2].

Acidochromic ionic liquids (ILs) may become a viable alternative to conventional hydrogen chromoionophores due to their ease of synthesis and tunable characteristics [3]. However, an overview of existing attempts to utilize acidochromic ILs as lipophilic hydrogen chromoionophores highlights the focus on exploring only a few specific applications of optical sensors based on such indicators.

Here we report a systematic study of the optical properties of lipophilized acidochromic dyes and their behavior in a polymeric sensor matrix, with the aim of finding a path toward readily available chromoionophores with tunable acidity. Lipophilic ion pairs of several sulfonaphthalein dyes with quaternary ammonium cations are synthesized and used as chromoionophores in coextraction-based PVC–DOS optodes. It is shown that the nature of the acidochrome and counterion determine the lipophilicity (fig. 1A) and acidity (fig. 1B) of the resulting ion pair. The partition coefficients of the obtained dyes are in the range from  $10^4$  to  $10^6$ . Finally, the possibility of utilising the previously reported theoretical description [4] in order to predict the properties of optodes based on such indicators was demonstrated (fig. 1C).

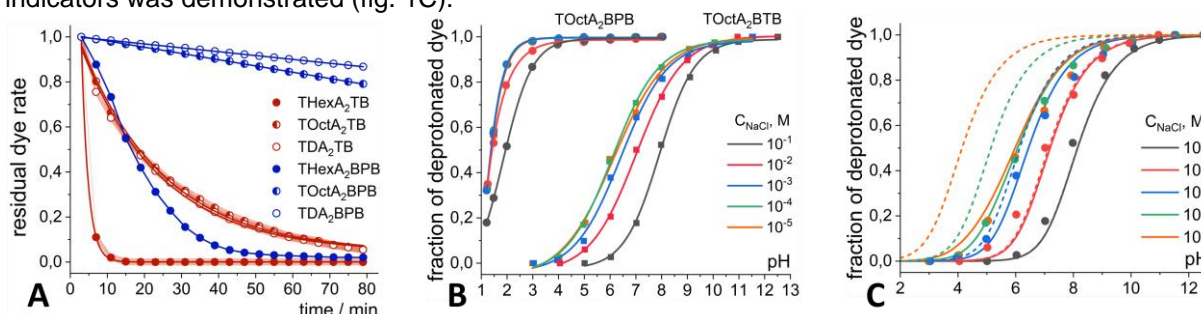

**Figure 1.** A: Residual amount of lipophilized dyes in deprotonated form relative to their initial content in the polymeric film, versus time of contact with the aqueous phase. B: pH-response curves of optodes containing bromophenol blue and bromothymol blue ion paired with TOctA<sup>+</sup> as pH-chromoionophores. C: pH-response curves of optodes containing bromothymol blue ion paired with TOctA<sup>+</sup> as pH-chromoionophores. Symbols: experimental data, dashed lines: prediction using conventional theory of the optode response, solid lines: prediction using generalized theory of the optode response [4].

## References

- [1] *Anal. Chim. Acta* **1993**, 278, 211
- [2] *Talanta* **2002**, 58, 909
- [3] *RSC Adv.* **2014**, 4, 7225
- [4] *ACS Sens.* **2023**, 8, 3086

## Acknowledgements

This work was supported by the Russian Science Foundation (project No 20-73-10033).

# APPLICATION OF IRON OXIDE NANOPARTICLES AS A MAGNETIC SORBENT IN MATRIX SOLID-PHASE DISPERSION FOR EXTRACTION OF TETRACYCLINES FROM MILK AND THEIR CHROMATOGRAPHIC DETERMINATION

*Purytskin I.P.<sup>1</sup>, Biryuzov A.A.<sup>1</sup>, Tolmacheva V.V.<sup>1</sup>, Apyari V.V.<sup>1</sup>*

<sup>1</sup> Lomonosov Moscow State University, Moscow, Russia

Student

[pi0521@yandex.ru](mailto:pi0521@yandex.ru)

Tetracyclines are a class of antibiotics which are widely used in practical medicine as effective antibacterial agents since the middle of the last century. High antimicrobial activity and relatively low cost of tetracyclines lead to their widespread use in animal husbandry for the prevention and treatment of infections. Uncontrolled usage of these drugs in veterinary practice leads to their accumulation in animal-derived food products and environmental objects. The presence of residual amounts of tetracyclines in food, water and soil has a negative impact on human health and the ecological situation, causing the growth of antibiotic resistant microorganisms. Due to the low content of tetracyclines in these matrices and the complexity of their composition, the determination of these antibiotics is preceded by a compulsory sample preparation step.

Matrix solid-phase dispersion (MSPD) is an up-to-date widely accepted technique for the one-step extraction of organic analytes. It was introduced in 1989 for drugs extraction from animal tissues [1]. The essence of the method is to disperse the analyzed sample with a suitable sorbent, transfer the obtained homogeneous mass into a column or a cartridge and elute the target analytes with a selected solvent. The dispersing is carried out by manual blending of a sample and a sorbent with non-porous material pestle and mortar. Acids, bases and different salts can be added as blending modifiers, sodium sulphate is usually used as a desiccant. The rapid development of the method was facilitated by the fact that it does not require special equipment and presents a simple and cheap sample preparation procedure under mild conditions that can be easily implemented in any laboratory. Currently, MSPD is used to isolate organic compounds from solid and liquid samples of food products, fruits, plants, and solid environmental objects before their chromatographic determination. Nowadays the development of this method is aimed at modification by new energy sources (ultrasound, vortex, microwave radiation, magnetic field) and finding new dispersant materials [2]. Magnetic properties of dispersant sorbents allow for ease removal of a sorbent from matrix by simple application of an external magnetic field thereby eliminating the long and labor-intensive stage of packing the sample into a column or a cartridge. There is a limited number of works proposing magnetic sorbents usage in this method [3, 4]. This technique was named magnetic-assisted matrix solid-phase dispersion.

Magnetic nanoparticles of iron oxide  $\text{Fe}_3\text{O}_4$  were first proposed to be used as a sorbent in matrix solid-phase dispersion. Magnetite nanoparticles were obtained by chemical precipitation. The sorption of tetracycline, oxytetracycline, chlortetracycline and doxycycline on magnetic nanoparticles in a static mode was studied depending on the phase contact time, solution pH, and sorbate concentration. Conditions for quantitative desorption of tetracyclines were selected. When choosing the conditions for matrix dispersion, the mass of magnetic nanoparticles, the amount of drying agent (sodium sulfate), temperature, blending time, and the type of washing liquid were varied. The method was applied for the analysis of milk samples.

## References

- [1] *J. Chromatogr.* **1989**, 475, 353
- [2] *Trends Anal. Chem.* **2019**, 118, 751
- [3] *J. Chromatogr. A.* **2017**, 1504, 17
- [4] *J. Chromatogr. A.* **2019**, 1594, 13

## Acknowledgements

The work was carried out within the framework of the State Assignment, topic no. AAAA-A21-121011990021-7. The authors express their gratitude to the Interdisciplinary Scientific and Educational School of Lomonosov Moscow University "The Future of the Planet and Global Environmental Changes."

# SUB-PPM SHORT-CHAIN FATTY ACIDS DETECTION WITH LANTHANUM(III) MODIFIED TIN DIOXIDE GAS SENSORS

*Sagitova A.S.<sup>1</sup>, Rumyantseva M.N.<sup>1</sup>, Krivetskiy V.V.<sup>1</sup>*

<sup>1</sup> Lomonosov Moscow State University, Moscow, Russia

Graduate student

[cagitova.a@gmail.com](mailto:cagitova.a@gmail.com)

Detection of volatile organic compounds in exhaled breath is promising and effective tool for health monitoring [1]. Miniature and highly sensitive semiconductor metal oxide gas sensors can be effectively used for this purpose [2]. In this work, we demonstrate pronounced sensitization of SnO<sub>2</sub>-based nanocomposites modified with La(III) towards short-chain fatty acids (formic, acetic, propionic and butyric acids).

Materials were synthesized by flame spray pyrolysis technique from 0.2 M solution of precursors in toluene and characterized by XRD, BET, TEM with EDX-mapping and Raman spectroscopy. Acidic properties of pure and La(III) modified SnO<sub>2</sub> were characterized by temperature-programmed desorption of ammonia (TPD-NH<sub>3</sub>) with mass spectral determination of desorption products. The La(III) modification leads to the decrease in crystalline grain size and increase in effective surface area of the materials; the formation of irregularly shaped particles of various sizes close to the calculated from XRD data; the segregation of La-containing phases in the case of material with higher content of lanthanum. It was demonstrated that decrease in the Lewis acidity of the SnO<sub>2</sub> surface leads to the specific increase in sensor response towards gases with acidic properties like short-chain fatty acids (SCFAs) and H<sub>2</sub>S. For all acids the most noticeable sensor response is observed in the case of material with lanthanum content of 2 mol. %. The greatest increase in sensor response compared to pure SnO<sub>2</sub> is observed for formic acid. The increase in the length of carbon chain requires additional activation of chemisorbed oxygen on the semiconductor surface, which leads to the shift in response maximum to higher temperatures. The obtained materials are capable of detecting short-chain fatty acids with sub-ppm concentrations at high air humidity (RH = 80%), which is promising for analysis of these biomarkers in exhaled breath.

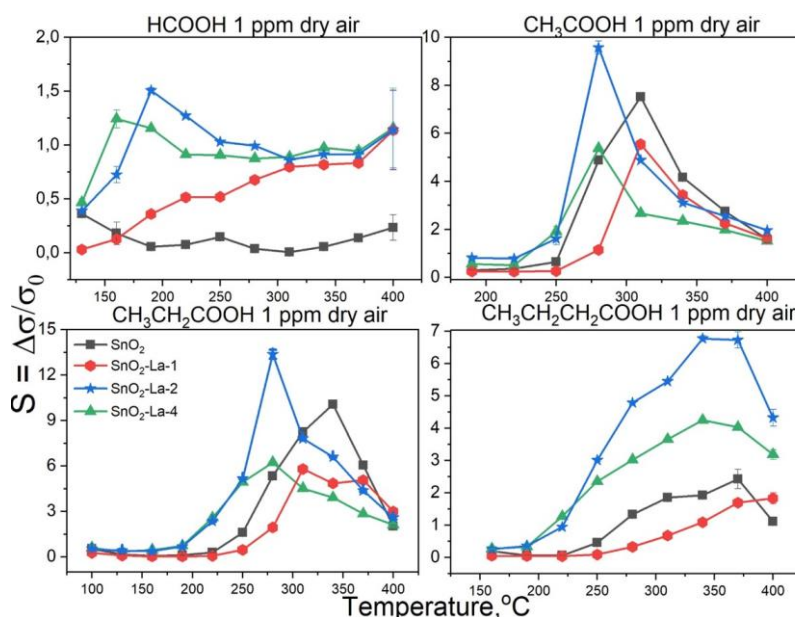

**Figure 1.** Temperature dependence of the sensor response of studied materials towards short-chain fatty acids.

## References

- [1] *J. Anal. Methods Chem.* **2019**, 2019, 1–14
- [2] *Lab Chip.* **2017**, 17, 3537–3557

## Acknowledgements

This work was supported by the Russian Science Foundation (22-13-00111).

## DETERMINATION OF HALITOSIS BY EXHALED BREATH ANALYSIS USING SEMICONDUCTOR METAL OXIDE SENSORS AND CHEMOMETRIC METHODS

*Saveliev M.<sup>1</sup>, Kirsanov D. <sup>1</sup>, Jahatspanian I.<sup>2</sup>*

<sup>1</sup> St. Petersburg State University, St. Petersburg, Russia

<sup>2</sup> Joint-Stock Company "NPO "Pribor", St. Petersburg, Russia

[mishasavelev@list.ru](mailto:mishasavelev@list.ru)

Halitosis is a condition associated with bad breath. The basis of bad breath are Volatile Organic Compounds (VOCs) that accumulate in the oral cavity due to various causes. The main source of these compounds (volatile sulfur compounds, organic acids, amines and volatile aromatic compounds) is the anaerobic metabolism of proteinaceous food residues by oral bacteria. In some cases, halitosis may be a consequence of the development of more serious diseases (diabetes mellitus, renal failure, azotemia, etc.) [1]

Currently, the main method of determining halitosis is the organoleptic method, which involves a trained professional evaluating the patient's exhaled air. The doctor gives a score between 0 and 5, where 0 corresponds to the absence of symptoms of halitosis and 5 corresponds to a very severe form of the disease. This method, although it has been in use for a long time, has a number of disadvantages. It requires a pre-trained specialist, whose training is a complex and nonstandard task, is subjective and inconvenient for both the patient and the doctor. A possible analog of this method is the use of automated gas analysis systems. "Electronic nose" multisensor systems have become a common solution in this field [3]. These systems consist of a set of cross-sensitive gas sensors, typically electrochemical or optical, providing responses to organic components of the analyzed air. Semiconductor metal oxide sensors have proven to be a very effective choice for the design of such systems due to their high cross-sensitivity to specific volatile organic compounds. Chemometric processing of response of these sensors allows constructing efficient air sample classification models, distinguishing various patterns.

In this study we consider the use of a multi-sensor gas analyzer ARAMOS-7 based on 7 semiconductor metal oxide sensors operating at 3 different fixed temperatures. Analyzed exhaled air samples were collected in clinical settings for 70 patients with the diagnosed halitosis and 30 patients with no complaints. The main idea of the study was to classify the patients into "normal" and "abnormal" groups based on the responses of the multisensor system. Various algorithms were employed for chemometric data processing: k nearest neighbors (kNN), logistic regression (LR), decision tree (DT), support vector machine (SVM), and projection on latent structures discrimination analysis (PLS-DA). All the employed classification methods have demonstrated their efficiency and yielded sensitivity, specificity and accuracy exceeding 85%. The feasibility of a combined classifier making a selection based on the responses of several algorithms was also demonstrated. with accuracy close to 100%.

### References

- [1] Kapoor, Uditi & Gaurav, Sharma & Juneja, Manish & Nagpal, Archana. *Halitosis: Current concepts on etiology, diagnosis and management. European Journal of Dentistry*, **10**, 2016, 292.
- [2] Rosenberg, M., & McCulloch, C. A. G. *Measurement of Oral Malodor: Current Methods and Future Prospects. Journal of Periodontology*, **63** 9, 1992, 776–782
- [3] Gardner, J. W., & Bartlett, P. N. *A brief history of electronic noses. Sensors and Actuators B: Chemical*, **18** 1-3, 1994, 210–211.



## REVERSIBLE POLYMER COLORIMETRIC pH SENSOR

*Serebryakov K.V., Khachkovskii A.V., Gaga A.S., Volgina T.N., Gavrilenko M.A.*

National Research Tomsk Polytechnic University, Tomsk, Russia

Student

[dce@mail.ru](mailto:dce@mail.ru)

Colorimetric pH sensors have been widely used over the past decade because they have a number of advantages such as low cost, high sensitivity, suitable selectivity, the ability to analyze real samples and remotely register a signal. Immobilization of various chromogenic acidic or basic indicators on solid matrices is a promising and inexpensive way to develop new sensors for colorimetry and solid-phase spectrophotometry, in this case, the fixation of the reagent on a solid carrier occurs through adsorption or covalent interactions.

The new colorimetric pH sensor is manufactured using covalent immobilization of the thymol blue indicator (TB) in a polymethacrylate matrix (PMM) as a solid carrier. The solid-phase extraction of TB into PMM was studied, the molar absorption coefficients of two extractable forms  $H_2R$ ,  $HR^-$  and acid-base properties of the indicator in the form of three ionic forms  $H_2R$ ,  $HR^-$ ,  $R^{2-}$  were determined.

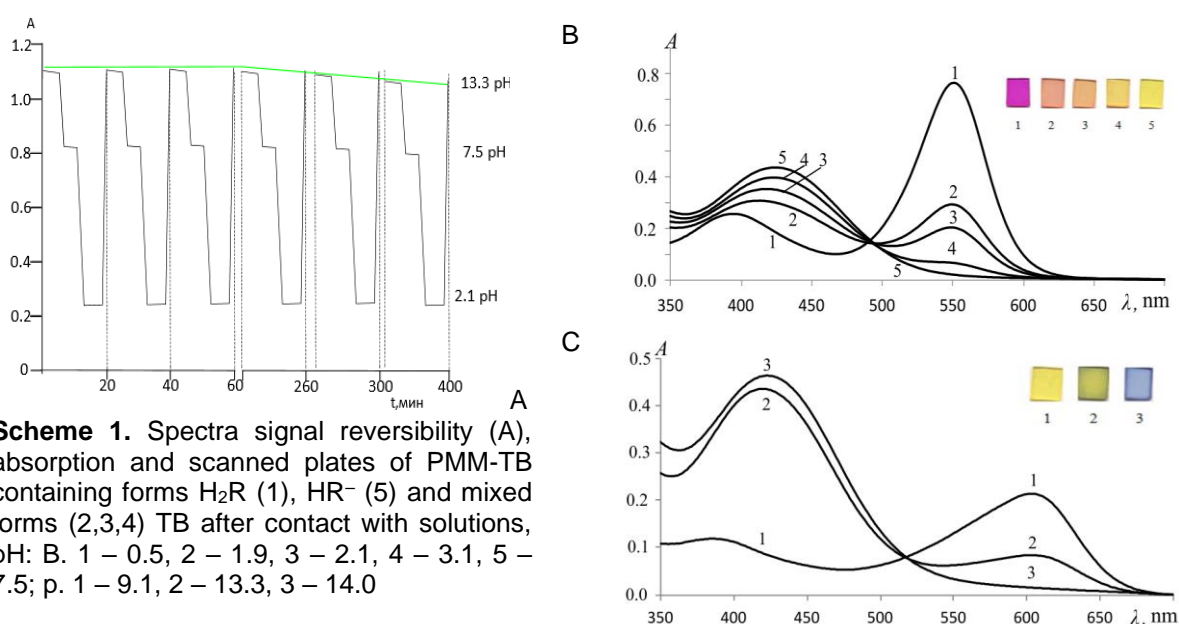

**Scheme 1.** Spectra signal reversibility (A), absorption and scanned plates of PMM-TB containing forms  $H_2R$  (1),  $HR^-$  (5) and mixed forms (2,3,4) TB after contact with solutions, pH: B. 1 – 0.5, 2 – 1.9, 3 – 2.1, 4 – 3.1, 5 – 7.5; p. 1 – 9.1, 2 – 13.3, 3 – 14.0

The factors influencing the sensor operation, including the pH of the dye binding to the PMM and the concentration of the dye, have been investigated. The sensor reacts to changes in the range pH 3.0–10.0 with a response time of 0.5 min and a reproducibility of  $RSD \leq 5.0\%$ . No significant changes in the sensor response were observed after an increase in the ionic strength in the range of 0.0–2.5 M of sodium chloride and in the presence of common oxidizing agents.

The reproducibility of the sensor signal at multiple pH values was investigated to demonstrate the repeatability and reversibility of the sensor. Buffer solutions with different pH values of 2.1, 7.5 and 13.3 were placed as test solutions in a spectrophotometer cuvette containing a sensor plate for up to 120 minutes. The RSD values of the results are less than 0.3%. The results showed that the sensor response is repeatable and reversible.

In this work, the acid-base properties of the triphenylmethane dye TB in PMM were studied by colorimetry and spectrophotometry. The advantages of colorimetry over classical instrumental methods for studying protolytic equilibria in dye solutions are shown. The colorimetry method, in contrast to spectrophotometry, allows us to determine the deprotonation constant of carbonyl groups of TB. The main spectrophotometric characteristics of the equilibrium forms of dyes were calculated and it was found that the anionic forms are the most intensely colored in PMM. The determination of pH using the proposed colorimetric sensor is fast, simple, inexpensive, selective and sensitive.

### Acknowledgements

This work was supported by the Russian Science Foundation (project No 24-24-00160).

# THE STUDY OF THE SORPTION OF RHENIUM FROM HYDROCHLORIC AND NITRIC ACID SOLUTIONS BY IMIDAZOLIUM POLYMER SORBENT FOR SUBSEQUENT MS-ICP DETERMINATION

*Shigapov I.V.<sup>1,2</sup>, Khromova I.A.<sup>1</sup>, Lubimov S.E.<sup>3</sup>, Dubenskiy A.S.<sup>2</sup>, Maksimova Y.A.<sup>2</sup>, Statkus M.A.<sup>1</sup>*

<sup>1</sup> Moscow State University, Moscow, Russia

<sup>2</sup> Geological Institute of the Russian Academy of Sciences, Moscow, Russia.

<sup>3</sup> A.N. Nesmeyanov Institute of Organoelement Compounds, Russian Academy of Sciences, Moscow, Russia.

Graduate student

[weertop@gmail.com](mailto:weertop@gmail.com)

The results of the trace element analysis of rocks are the basis for the modelling and interpreting of many geological processes. Their scientific value is provided by a wide range of definable components, the accuracy of the analysis, comparability with international data and the necessary sensitivity.

Existing methods of trace element analysis do not allow directly determining the amounts of some elements at the level characteristic of ultramafic rocks, even using the modern highly sensitive inductively coupled plasma mass spectrometry (MS-ICP) method. These are some siderophilic elements, particularly Re and Os, the content of ones in samples of this type is about 0.0x µg/g. In this regard, it is necessary to carry out additional preconcentration procedures for their reliable determination with the required sensitivity.

When samples are dissolved in hydrochloric and nitric acids, rhenium transforms into negatively charged anions (aqua-, hydroxo-, and oxo-chloro complexes; chloro complexes or oxoanions) [1], which makes it possible to extract Re from solutions of complex composition using anion-exchange resins. Currently, there are procedures for the sorptive preconcentration of rhenium using imidazole resin [2,3], but ones were researched only in static mode.

This project is devoted to developing of a new approach to sorptive preconcentration of Re in its joint determination with osmium (in the case of Re-Os isotope dating of ultramafic rocks). Polystyrene modified with imidazole groups is used as sorptive material (Fig.1). Using polymer sorbents allows for preconcentration of analytes from strong acid media in a dynamic mode, which is more user-friendly for routine analysis.

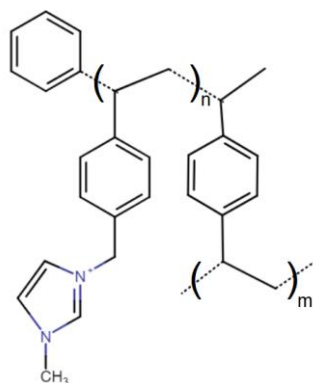

**Figure 1.** The structural formula of repeating units of the experimental imidazolium sorbent used.

In this research, optimal conditions of the sorption and desorption (pumping rate, acid concentration, column length, desorption solution composition) of rhenium by experimental imidazolium sorbent were determined.

## References

- [1] Marković B. M. et al. Selective magnetic GMA based potential sorbents for molybdenum and rhenium sorption // *Journal of Alloys and Compounds*. 2017. V. 705. P. 38-50. <https://doi.org/10.1016/j.jallcom.2017.02.108>.
- [2] Miao X. et al. Radiation synthesis of imidazolium-based polymeric ionic liquid gel for efficient adsorption of Re (VII) and U (VI) from aqueous solution // *Environmental Science and Pollution Research*. 2022. V. 29. I. 46. P. 69967-69979.
- [3] Lou Z. et al. Selective adsorption of Re (VII) by chitosan modified with imidazolium-based ionic liquid // *Hydrometallurgy*. 2018. V. 179. P. 141-148.

# PULSED GLOW DISCHARGE MASS SPECTROMETRY FOR VOC DETERMINATION IN AIR SAMPLES BEFORE AND DURING SURGERY TO REMOVE A BLADDER TUMOR

*Sidelnikov V.O.*<sup>1,2</sup>, *Ganeev A.A.*<sup>1</sup>, *Chuchina V.A.*<sup>1</sup>, *Kravtsov D.V.*<sup>1,3</sup>, *Gubal A.R.*<sup>1</sup>, *Krylov O.A.*<sup>4</sup>

<sup>1</sup> Lumex LLC, St. Petersburg, Russia

<sup>2</sup> Information Technologies, Mechanics and Optics University, St. Petersburg, Russia

<sup>3</sup> Institute for Analytical Instrumentations, St. Petersburg, Russia

<sup>4</sup> Mariinsky Hospital, St. Petersburg, Russia

Master student, research engineer

[sidelnikovvo@lumex.ru](mailto:sidelnikovvo@lumex.ru)

Volatile Organic Compound (VOC) identification methods required in many medical applications. In fact, these techniques allow the detection of disease markers in exhaled air or gas mixture samples collected during surgical procedures. For example, one of the most important issues is the determination of tumor markers by analyzing samples taken during transurethral resectoscopy of the prostate (TURP) and bladder (TURB). On the other hand, during TURP and TURB, carcinogenic volatile organic compounds occur as a result of the interaction of the resectoscope with the tumor. The analytical methods available today (e.g., gas chromatography mass spectrometry (GC-MS)) have several drawbacks, including strict sampling requirements and low sensitivity for direct analysis of VOC mixtures. Recently, our research group has been developed approaches to the direct determination of VOCs and inorganic compounds in gas samples using pulsed glow discharge mass spectrometry (GD-MS) [1, 2]. This method provides the opportunity for direct, rapid, and highly sensitive analysis of gas samples.

In the present work, we have developed an approach for the analysis of samples obtained before and during TURB using a mass spectrometer with a pulsed glow discharge “Lumas ITR-301” (Lumex LLC). Air samples were taken before and during surgery in the urology department of the Mariinsky Hospital. For comparative studies, we also collected samples before and during TURB into sorption tubes for analysis by GC-MS. As opposed to GC-MS, GD-MS analysis was performed using direct input. Discharge parameters were optimized for the most efficient ionization of VOCs. The background mass spectrum obtained from the analysis of the hospital sample before surgery was subtracted from the mass spectrum of the sample obtained at surgery. Mass spectra analysis of VOCs released during TURP and TURB was performed according to the list of bladder tumor biomarkers described in the literature [3–5]. As a result, we have provided a list of compounds (isobutylene, 2-butanone, ethanol, 3-heptanone, hexanal, etc.) detected in air samples using both GD-MS and GC-MS analytical techniques. We would like to highlight that classical analysis using gas chromatography allow to detect a significantly smaller range of compounds. Thus, the proposed direct analytical methods allow to increase the sensitivity and accuracy of tumor biomarker detection in gas mixtures collected during surgery. In addition, the proposed GD-MS method requires a much simpler gas mixture collection procedure, which makes the proposed technique more applicable in hospital conditions.

## References

- [1] *Molecules* **2022**, *27*(20), 6864
- [2] *Analitika i kontrol* **2024**, *27*(4), 208-218
- [3] *IJU* **2010**, *17*, 944-949
- [4] *Metabolites* **2021**, *11*(1), 17
- [5] *Urology* **2013**, *82*(3), 744.E9-744.E14

## Acknowledgements

This work was supported by the Russian Science Foundation (project No 22-23-00636).

# STUDY OF THE RETENTION MECHANISM FOR ORGANIC AND INORGANIC IONS IN HILIC WITH SILICA- AND POLY(STYRENE-DIVINYLBENZENE)-BASED STATIONARY PHASES

*Smagina M.A., Shemiakina A.O., Ivanova E.D., Chernobrovkina A.V., Shpigun O.A.*

Lomonosov Moscow State University, Chemistry Department, Moscow, Russia  
Master's student

Hydrophilic interaction liquid chromatography (HILIC) is a modern promising method for the separation and determination of polar compounds. This method attracts analysts' attention due to its ability of simultaneous separation of positively and negatively charged analytes. It is necessary to understand the retention mechanism for various substances in order to select the optimal conditions for such analyses. The retention mechanism in HILIC is complex and still not fully understood. It is considered that adsorption, partitioning, and electrostatic interactions may contribute simultaneously to retention. In the case of mixed-mode stationary phases based on hydrophobic polymer substrate, additionally hydrophobic and  $\pi$ - $\pi$  interactions take place [1]. Understanding the processes occurring in the chromatographic system makes it possible to develop the method. It allows to expand its theoretical basis, to find new approaches for characterization of adsorbents, and to control the separation efficiency and selectivity in HILIC mode.

In this work, a set of test ions was selected: p-toluenesulfonate, alkylsulfonates, chloride, nitrate, single- and double-charged inorganic cations. Their retention mechanism was studied for silica- and poly(styrene-divinylbenzene)-based stationary phases with predominant anion-exchange properties. A universal evaporative light-scattering detector was chosen to provide the required sensitivity. Mixtures of ammonium-acetate buffer solution, pH 4.7 and acetonitrile were used as mobile phases. The contribution of electrostatic and hydrophilic interactions to the retention of model analytes was evaluated by varying the concentration of eluting ion and the fraction of organic solvent in the mobile phase.

A decrease in the contribution of electrostatic interactions with decreasing hydrocarbon chain length was shown on silica phases for methane-, ethane-, propane-, and butanesulfonate anions. The opposite dependence was demonstrated for poly(styrene-divinylbenzene)-based adsorbents, with the lowest contribution observed for p-toluenesulfonate ion. This compound is used as a marker of anion exchange selectivity in the Tanaka HILIC test [2], but according to the data obtained and literature [1] it is not suitable for mixed-mode stationary phases due to the significant contribution of hydrophobic and  $\pi$ - $\pi$  interactions into its retention. More hydrophilic anions like methanesulfonate may represent an alternative to this parameter.

Varying the eluting ion concentration in the mobile phase, it was shown that electrostatic repulsion governed the retention of single-charged inorganic cations ( $\text{Li}^+$ ,  $\text{Na}^+$ ,  $\text{K}^+$ ) when using stationary phases of both types. Nevertheless, all the studied cations had reasonable retention factors on the anion-exchangers with the elution order opposite to that in cation-exchange chromatography due to partitioning. This process significantly prevailed over the repulsion of cations from the positively charged functional layer of the stationary phase [3]. As a result, it was possible to separate five monovalent inorganic ions both cations and anions using amino-modified stationary phases in a single run.

## References

- [1] Popov A.S., et al. Prospects of using hyperbranched stationary phase based on poly(styrene-divinylbenzene) in mixed-mode chromatography // *J. Chromatogr. A*. 2021. Vol. 1642. P. 1-6.
- [2] Kawachi Y., et al. Chromatographic characterization of hydrophilic interaction liquid chromatography stationary phases: Hydrophilicity, charge effects, structural selectivity, and separation efficiency // *J. Chromatogr. A*. 2011. Vol. 1218. P. 5903-5919.
- [3] Liu X., et al. HILIC behavior of a reversed-phase/cation-exchange/anion-exchange trimode column // *J. Sep. Sci.* 2010. Vol. 33. P. 779-786.

## Acknowledgements

This work was supported by the Russian Science Foundation (project No 20-13-00140).

3D PRINTING WITH A POLYMER MODIFIED USING MOLECULAR EMITTERS BASED ON  
CYCLOMETALLIC EUROPIUM COMPOUNDS FOR THE DEVELOPMENT OF A  
"SPECTROPHOTOMETER IN A CUVETTE"

*Smolyanov N.A.<sup>1</sup>, Kirsanov D.O.<sup>1,2</sup>*

<sup>1</sup> ITMO National research university, St. Petersburg, Russia

<sup>2</sup> St. Petersburg State University, St. Petersburg, Russia  
Student

[smoljanov13@mail.ru](mailto:smoljanov13@mail.ru)

The development of new analytical devices complying with modern requirements of simplicity and cost-effectiveness is an important task. In recent years, there has been a growing interest in creating inexpensive analyzers based on consumer electronics devices, primarily mobile phone cameras, which allow reliable optical detection in numerous analytical tasks [1]. In this paper, a new scheme for using a mobile phone camera to register an optical signal in the chemical analysis of solutions is proposed. With the help of 3D printing technologies, we have made a specialized cuvette, the bottom of which is printed with a polymer modified by molecular emitters based on cyclometallic compounds of europium. When irradiated with an ultraviolet flashlight (365 nm), the lower part of the cuvette becomes a source of a light with a sharp maximum at a wavelength of 614 nm. This makes it possible to use such a cuvette to analyze solutions absorbing in this region of the spectrum, registering the intensity of the transmitted radiation using a mobile phone camera. The report will present the details of the developed method and demonstrate its utility in quantitative analysis of aqueous solutions. The feasibility of the method was explored using model mixtures of inorganic salts, and real life applicability was shown for quantification of ascorbic acid in pharmaceuticals.

### References

[1] Measurement, **2021**, *171*, 108829

### Acknowledgements

This work was supported by the Russian Science Foundation (project No 23-73-01139).

# TAILORING DIGITAL MACROPHOTOGRAPHY FOR IMAGING OF OPTICAL SENSORS

*Syutkin V.S.<sup>1</sup>, Peshkova M.A.<sup>1</sup>*

<sup>1</sup> St. Petersburg State University, St. Petersburg, Russia

Student

[susutkin@mail.ru](mailto:susutkin@mail.ru)

The demand for fast and accurate methods with the prospect of miniaturizing sensing systems for measurements in small sample volumes has prompted new options of optical sensors signal registration. The colorimetric response of the optodes is detected by spectrophotometry or macrophotography with subsequent digital color analysis (DCA). Compared to other traditional methods, digital color analysis has several advantages, including higher throughput, shorter analysis time, better capacity and reliability, and *in situ* analysis capability, since the signal can be recorded with consumer devices. To achieve such advantages, many features and issues of optode measurements in real samples should be taken into account (complex sample matrix, native sample color, lighting instability etc.). This contribution is aimed at comparing several optode signal registration systems, as well as at reporting our experimental results on introducing shielding agents into the optodes polymeric matrix to eliminate color interference from the measured samples.

The comparison of various registration methods (spectrophotometry and photographing with a digital consumer camera, a smartphone or a microscope camera) using compositions with the combination of a chromoionophore, an ionic additive and an ionophore in plasticized poly(vinylchloride) membrane was performed. Composition 1 and 2 differed in the nature of the chromoionophore (lipophilic indicator), Fig. 1A. The recording devices were smartphone cameras, a digital camera and a microscope (Table 1). Illumination was provided by incandescent lamps (Philips, natural light, 60 W) and the flash of the phone 2. Photographing at an angle of 45° to the sample was also tested for phone 2.

**Table 1.** Various recording devices.

recording devices	commercial names
phone camera 1 (below the average price category)	Xiaomi Redmi Note 8 Pro, 2019
phone camera 2 (above the average price category)	Huawei P60 Pro, 2023
digital consumer camera	Canon EOS 1100D Kit, equipped with a lens Canon EF-S 18-55mm f/4-5.6 IS STM
research class microscope camera	LOMO MSP-2, equipped with a digital camera MP-5, software MS View

The parameter “robustness” was used for comparison of the recording devices [1], where vectors in RGB color space were compared. This parameter was calculated as follows:

$$Rob = \frac{\text{dynamic range(rad)}}{\text{standard deviation(rad)}} \quad (1)$$

For another experiment, 3 compositions with the same ratio of active components but with different matrix constituents were prepared: PVC:DOS:TiO<sub>2</sub> = 6:16.5:0, 6:16.5:3 and 6:16.5:6. A uniform optode composition without TiO<sub>2</sub> was prepared in a 1 mL eppendorf, while 3 and 6 mg of TiO<sub>2</sub> were put into the other two eppendorfs, respectively. Then the stock composition was divided into 3 parts and filled into appropriate containers. Before dropping each sensor, the mixture was shaken by the centrifuge-vortex BioSan Combi-Spin FVL-2400N. To validate the shielding effect of TiO<sub>2</sub> inside the PVC matrix, all compositions were measured on polypropylene substrates with 3 different backgrounds - white, black and beige (Fig. 1B).

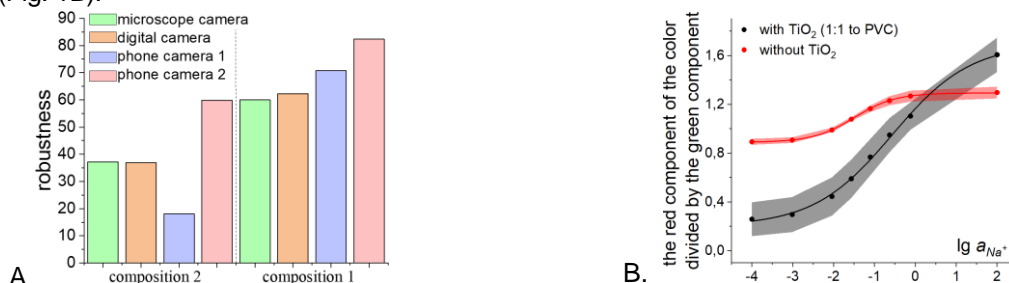

Fig. 1. The obtained results. A – parameter «robustness» for all recording devices; B – experiment on the introduction of a shielding agent on a beige background (E9C8BC);

## References

[1] *Sensors and Actuators B: Chemical*. 2021. 344, 130274.

## Acknowledgements

This work was supported by the Russian Science Foundation (project №20-73-10033).

# MIXED-MODE POLYMER-BASED STATIONARY PHASES WITH GRAFTED ZWITTERIONIC CHAINS

*Talipova I.I., Gorbovskaia A.V., Uzhel A.S.*

Moscow State University, Moscow, Russia

Student

[ilsina.talipova@chemistry.msu.ru](mailto:ilsina.talipova@chemistry.msu.ru)

The design of novel mixed-mode stationary phases is a current direction of development in the field of HPLC. In their structure there are various functional groups that make it possible to use such separation materials in different chromatography modes: reverse phase (RP HPLC), ion-exchange (IEC) and hydrophilic interaction liquid (HILIC) chromatography. Majority of mixed-mode stationary phases are based on silica, which is stable in a limited pH range (from 2 to 8). As a result, such phases can't be used with strongly acidic or strongly basic mobile phases. A promising approach is the transition from silica to a copolymer of styrene and divinylbenzene (PS-DVB) with a high degree of cross-linking, which is stable over a whole pH range and is compatible with organic solvents [1].

One of the types of mixed-mode stationary phases for HPLC is zwitterionic stationary phases containing both positively and negatively charged groups. These stationary phases are highly hydrophilic, biocompatible, and can be used for simultaneous separation of anions and cations [2].

In this work, mixed-mode zwitterionic stationary phases based on modified PS-DVB were synthesized. The modification was carried out in two ways: acylation with reductive amination with methylamine and epoxidation followed by amination with methylamine. Polyelectrolyte chains were prepared from 1,4-butanediol diglycidyl ether (1,4-BDDGE) and iminodiacetic acid, as well as from 1,4-BDDGE and methyl glycine. Additionally, positively charged chains formed from 1,4-BDDGE and dimethylamine were sequentially grafted to form an external functional anion-exchanging layer.

The synthesized resins were investigated in three retention modes: RP HPLC, IEC and HILIC. It was noted that grafting of positively charged chains leads to a hydrophilicity increase of the stationary phases in the HILIC mode, but an efficiency decrease in the RP HPLC mode. A mixture of 14 anions containing standard anions, lactate, bromate and anions of 5 phosphonic acids was separated in IEC mode in 32 min in a gradient elution mode. In the RP HPLC mode, the ability to separate a mixture of 7 alkylbenzenes in 20 min (with an efficiency of up to 15,000 tp/m), 3 fat-soluble vitamins in 15 min (with an efficiency of up to 3,000 tp/m), as well as a mixture of phenol and 5 of its derivatives in 15 min (with efficiency up to 9,000 tp/m) was shown. The stationary phases in HILIC mode made it possible to separate 5 water-soluble vitamins in 12 min in isocratic elution mode (with an efficiency of up to 14,500 tp/m) and 6 water-soluble vitamins in 9 min in gradient elution mode (with an efficiency of up to 13,500 tp/m), 4 nitrogenous bases in 3.5 min (with an efficiency of up to 10,000 tp/m) and 10 amino acids in 24 min (with efficiency up to 21,000 tp/m) in isocratic elution mode.

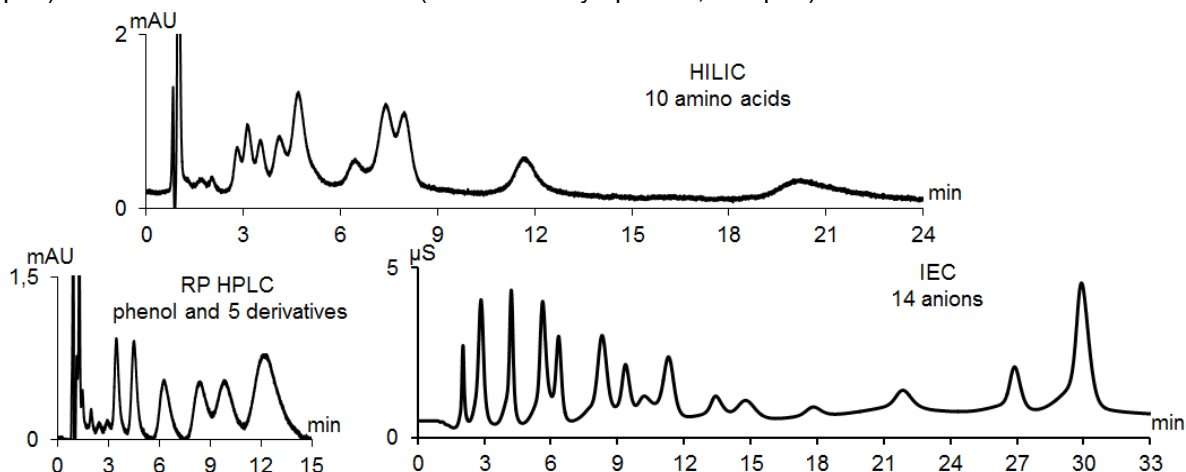

Figure 1. Separation of mixtures in different chromatography modes.

## References

- [1] *Microchemical Journal*, **2024**, 199, 110075
- [2] *Journal of Chromatography A*, **2024**, 1714, 464586

## Acknowledgements

This work was supported by the Russian Science Foundation (project No 23-73-01145)

## STUDY OF ORGANIC MATTER DISTRIBUTION IN OIL SHALE BY MICRO-FTIR AND SEM-EDS

*Tanykova N.G., Chudova E.S., Petrova Yu.Yu.*

Surgut State University, Surgut, Russia

Researcher

[tanykova\\_ng@surgu.ru](mailto:tanykova_ng@surgu.ru)

The distribution of organic matter (OM) in oil shales and its chemical composition is essential for the successful field development and hydrocarbon production. Fourier transform infrared microscopy (micro-FTIR) is a non-destructive method of analysis that can be used to study the structure and composition of a sample on a micrometre scale. Colour mapping allows the distribution of OM and minerals on the rock surface to be visualised. Scanning electron microscopy (SEM) provides information on the shapes, sizes and distribution of minerals and kerogen grains in shale, while energy dispersive X-ray spectroscopy (EDS) provides information on its elemental composition.

The object of the study was a sample of oil shale taken from the Salym field, collected from a depth of approximately 3 km. The programmed pyrolysis data indicates that the sample is a high-carbon rock (total organic carbon content TOC =  $9.6 \pm 0.5$  wt.%), contains mature OM ( $T_{\max} = 432-436^{\circ}\text{C}$ ), and is in the active stage of HC generation (PI = 0.1, which corresponds to the main zone of oil formation).

The results of the structural group analysis, based on the classification of the main rock types of the Bazhenov Formation, indicate that the sample belongs to a clay-carbonate-siliceous rock with a variable composition [1]. The characterisation stretch vibrations of C–H bonds of aliphatic fragments of OM were observed in the region  $2910-2890\text{ cm}^{-1}$  [2, 3]. In the region  $1450-1410$  and  $875-870\text{ cm}^{-1}$  the observed bands can be attributed to the stretch and bending vibrations of carbonate anion ( $\text{CO}_3^{2-}$ ) bonds of carbonate minerals; in the region  $1100-1000\text{ cm}^{-1}$  – the stretch vibrations of Si–O–Si bonds of clay and siliceous minerals; in the region  $850-750\text{ cm}^{-1}$  – the stretch vibrations of  $\text{SiO}_2$  bonds of quartz [2, 3].

The contents of OM and rock minerals were calculated by normalising the IR spectra. The average content of clay minerals in the sample is  $65.0 \pm 1.9$  wt.%, carbonate minerals -  $20.0 \pm 2.1$  wt.%, quartz -  $14.0 \pm 1.4$  wt.%. The mapping of the sample surface by the intensity of the absorption band of aliphatic fragments at  $\sim 2900\text{ cm}^{-1}$  revealed the following: blue zones with low band intensity and low content of OM (less than 1 wt.%); green zones, where the average content of OM is  $1.0 \pm 0.3$  wt.%; rare red zones with intense bands and high content of OM (up to 6 wt.%). The absorption bands of OM (violet zones) were not detected in all points of the investigated surface, which allows us to conclude that its distribution on the rock surface is extremely heterogeneous.

The SEM-EDS data indicated that oxygen, silicon and carbon constituted the majority of the sample. Carbon (20 wt.%) was present in both the composition of carbonate minerals (e.g., aragonite, dolomite, calcite, etc.) and in the form of carbon-containing organic compounds (e.g., kerogen). Furthermore, the presence of carbonate minerals confirmed the presence of calcium (6 wt.%). The high silicon content (21 wt.%) corroborates the presence of silicate-type structural minerals (illite, coalinite, quartz) containing potassium (1 wt.%) and aluminium (4 wt.%). Sulphur (4 wt.%) and iron (6 wt.%) indicate the presence of pyrite in the rock. The mineralogical composition of the rock was determined by SEM-EDS. In terms of oxide forms, the average values of mass concentrations were:  $\text{Al}_2\text{O}_3$  – 17 wt.%;  $\text{SiO}_2$  – 49 wt.%;  $\text{SO}_4^{2-}$  – 20 wt.%;  $\text{K}_2\text{O}$  – 1 wt.%;  $\text{CaO}$  – 15 wt.%;  $\text{Fe}_3\text{O}_4$  – 8 wt.%. The SEM-EDS results demonstrated a good agreement with the data obtained by micro-FTIR, confirming the homogeneous distribution of minerals on the rock surface.

### References

- [1] *Georesources* **2017**, *Special issue. Part 2*, 155
- [2] *J. of Microscopy* **2017**, *265*(1), 60
- [3] *Organic Geochemistry* **2013**, *63*, 1

### Acknowledgements

The study was financially supported by Government of Khanty-Mansiysk Autonomous Okrug - Yugra (order from 20.06.2023 № 10-P-1534).



# ANALYSIS OF BEVERAGES AND ORAL HYGIENE PRODUCTS USING NOVEL STATIONARY PHASES FOR ION CHROMATOGRAPHY

*Timichev A.A., Pogonia E.V., Gorbovskaia A.V., Uzhel A.S.*

Moscow State University, Moscow, Russia

Student

[timsenin@gmail.com](mailto:timsenin@gmail.com)

Nowadays, one of the most significant challenges is the control of food, beverages, and hygiene products quality. The determination of the anionic composition of these samples is of paramount importance, for example, the determination of nitrates and nitrites in drinking water [1] or the active fluorinating component in toothpaste and oral rinses [2]. The most effective modern method for anion profile determination is suppressed ion chromatography (IC). Some simple tasks, such as water quality analysis, can be performed using a carbonate eluent, while for more complex problems, such as wine and juice analysis, gradient elution mode using a hydroxide eluent is required. The appropriate stationary phase and eluent need to be selected for each specific application [3]. In this context, the development of new selective and efficient stationary phases for IC is the most important challenge facing researchers.

Novel resins based on styrene and divinylbenzene copolymer have been developed in the laboratory of chromatography at the Chemistry Department of Lomonosov Moscow State University. Stationary phase with polymerized glycidyl methacrylate on the surface of a polymer matrix were developed (Scheme 1, A). The anion-exchange layer was formed by the reaction of a tertiary amine with the oxirane ring of glycidyl methacrylate. The obtained sorbent was stable at pH < 12 and could be used with carbonate buffer solution as an eluent in suppressed IC. Such stationary phase with a simple functional layer was successfully applied for analysis of drinking water, soft drinks and oral rinses.

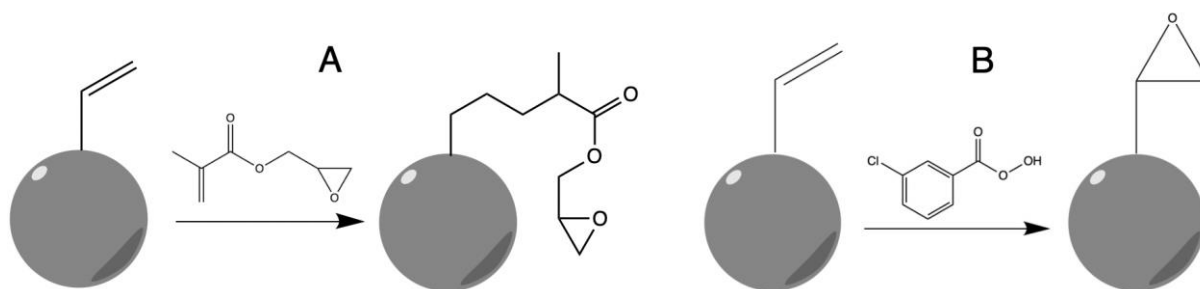

**Scheme 1.** Activation of polymeric substrate via A) polymerization of glycidyl methacrylate; B) epoxidation of surface double bonds.

To obtain anion exchangers with more complex functional layer stable over the entire pH range, a method of the polymer matrix activation by epoxidizing the surface double bonds with peroxy acid was used (Scheme 1, B). The obtained product was aminated with methylamine, then alkylated with diglycidyl ether with following covalent attachment of polyamine to the resin surface. For quaternization of the polyamine amino groups and crosslinking of the polymer layer, the obtained phase was finally treated with diglycidyl ether. The produced sorbent was suitable for use with hydroxide eluent, which allowed to determine the anionic composition of more complex soft drinks, as well as toothpastes. The methods for analysis of beverages and oral hygiene products using novel anion exchangers were developed and validated with respect to linearity, recovery, limits of detection, and intra-day and inter-day precision.

## References

- [1] *J. Chromatogr. A* **2004**, 1045, 153
- [2] *J. Zhejiang Univ. Sci. B* **2007**, 8, 507
- [3] *J. Food Compos. Anal.* **2021**, 95, 103674

## Acknowledgements

This work was supported by the Russian Science Foundation (project No 20-13-00140).

# CHEMICAL SENSORS FOR POTENTIOMETRIC MONITORING IN THE PRODUCTION OF RADIOPHARMACEUTICAL YTTRIUM-90

*Timoshenko V.V.<sup>1</sup>, Harb A.H.<sup>2</sup>, Ermolenko Yu.E.<sup>1</sup>, Smirnov I.V.<sup>1</sup>*

<sup>1</sup> St. Petersburg State University, St. Petersburg, Russia

<sup>2</sup> Atomic Energy Authority, Hot Laboratories Center, Nuclear Chemistry Department, Cairo, Egypt

Graduate student

[v.v.timoshenko@spbu.ru](mailto:v.v.timoshenko@spbu.ru)

Russia, having advanced technologies for obtaining and purifying radionuclides, still does not make enough use of the capabilities of nuclear medicine. In recent years, certain advances have been made in the field of oncological diagnostics using positron emission tomography (PET), but the use of radionuclides in radiotherapeutic treatment is extremely limited. Significant progress, in our opinion, can be achieved using radiopharmaceuticals based on yttrium-90 for radiotherapy - the only medical radionuclide, the production of which does not require either a reactor or a cyclotron. The source of yttrium-90 – strontium-90 – is formed during the reprocessing of spent nuclear fuel from nuclear power plants.

The high potential of radiopharmaceuticals based on yttrium-90 is due to its unique properties: the high energy of beta particles makes it suitable for irradiating large tumors, and the tendency to form complex compounds allows one to obtain a wide range of radiopharmaceuticals.

An obstacle to the large-scale use of this effective and accessible radionuclide in nuclear medicine is the insufficiently effective and safe methods for separating yttrium-90 from the parent strontium-90 and the lack of a safe, simple and reliable yttrium-90 generator.

The goal of our project is to create a radiation-safe two-circuit generator for producing high-purity yttrium-90 trichloride without a carrier, which is used in the palliative treatment of bone metastases and is the initial pharmaceutical substance for obtaining radiopharmaceuticals for radiotherapy of oncological diseases.

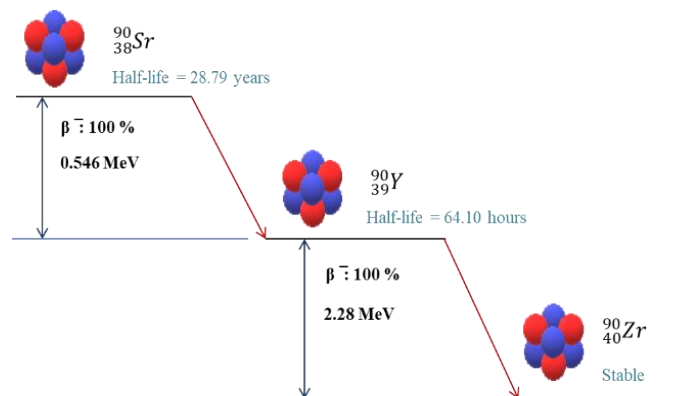

**Scheme 1.**  $^{90}\text{Sr}$  in equilibrium with its  $^{90}\text{Y}$  daughter ( $E_{\text{max}}= 2280 \text{ keV}$  and  $t_{1/2}= 64.10 \text{ hours}$ ).

The scientific idea of the project is related to the use of carbonate media to separate the medical radionuclide yttrium-90 from the parent strontium-90. Carbonate media, in contrast to traditional nitrate media, make it possible to create a generator in which the parent strontium-90 is reliably fixed in a solid matrix, which significantly increases radiation safety. To control washability, a previously developed ion-selective strontium electrode will be used.

During the work, chemical sensors with liquid polymer membranes selective for yttrium were obtained and tested. The matrix was PVC, the plasticizers were dibutyl and didodecyl phthalates, and the ionic conductor was methyltrioctylammonium carbonate. 8-hydroxyquinoylene and 2,3-dihydroxynaphthalene were used as ionophores.

## References

- [1] *Chem. Soc. Rev.* **2020**, 49 (17), 6169-6185
- [2] *Radiochemistry* **2023**, 65, 87-90

## Acknowledgements

This work was supported by the Russian Science Foundation (project № 24-63-00006), <https://rscf.ru/project/24-63-00006/>.

## DETERMINATION OF BIOACTIVE COMPOUND IN PRIMULA VERIS USING DEEP EUTECTIC SOLUTIONS

*Urusova S.V.<sup>1</sup>, Shishov A.Yu.<sup>1</sup>, Melesova M.A.<sup>1</sup>*

<sup>1</sup> St. Petersburg State University, St. Petersburg, Russia  
Student  
[st106271@student.spbu.ru](mailto:st106271@student.spbu.ru)

Plants of the genus *Primula* are used in traditional medicine to treat various diseases. Commonly, plants are applied to treat eye diseases, respiratory tract infections, headaches, etc. Alkaloids, flavonoids, glycosides, tannins, terpenes, polysaccharides, essential oils, coumarins, fatty acids are important from a medical point of view phytocomponents of species of the genus *Primula*. Pharmacological studies have shown their outstanding biological activity, such as antibacterial, antioxidant, antiviral, decongestant, antitumor, cardioprotective and contraceptive properties [1].

Various methods are used to extract bioactive compounds (BAC) from plant matter. The most widespread method is liquid extraction using water or aqueous solutions, as well as organic solvents such as alcohols or acetonitrile. However, organic solvents are quite toxic and volatile, especially at elevated temperatures, which are used to intensify the extraction process, and therefore, there has recently been a tendency to switch to "green" chemistry, which means replacing traditional solvents with new extractants. For example, such eco-friendly solvents that have shown their effectiveness in extracting BAC from plant raw materials are deep eutectic solvents (DES). The extraction of BAC could be described as the following: the plant material, which has been dried and finely ground to a powdery form, is mixed with a suitable solvent; then the mixture is heated and treated with ultrasound or microwave radiation.

In our work, we studied the following factors which impact the efficiency of BAC extraction from *Primula*: the DES composition, extraction time and temperature, as well as the solid-to-liquid ratio. Organic acids (lactic, malonic and malic), ethylene glycol, urea and sugars (glucose, fructose, sorbitol) acted as donors of the hydrogen bond in the composition of the DES, and choline chloride was used as an acceptor. The extracts were analyzed by HPLC-UV method. During the work, the flavonoid rutin was found and identified in plant raw materials, and the selectivity of extraction of polar and nonpolar compounds depending on the composition of DES was shown.

### References

[1] *Primula* and its role in phytomedicine; a systematic review, *Phytomedicine Plus* 4, **2024**,100510.

### Acknowledgements

This work was supported by the Russian Science Foundation (project No 22-73-10039). Scientific research was partially performed at the Chemical Analysis and Materials Research Centre of Saint Petersburg State University.

## BETA-LACTAM ANTIBIOTIC STABILITY IN CHICKEN MEAT

*Usanova E.D.<sup>1</sup>, Melekhin A.O.<sup>2</sup>*

<sup>1</sup> Moscow State University, Moscow, Russia

<sup>2</sup> Federal Centre for Animal Health, Russia

Student

[usanova.e.d@gmail.com](mailto:usanova.e.d@gmail.com)

$\beta$ -lactam antibiotics are widely used in human and veterinary medicine for the prevention and treatment of diseases, and also as growth promoters. A current problem is their contamination of food products as a result of improper and uncontrolled use, since even small quantities can cause allergic reactions. In addition, the possibility of the emergence of resistant strains of bacteria increases, both within animals and within humans, due to the ingestion of small doses of antibiotics from food, which can lead to outbreaks of diseases [1]. Therefore, it is necessary to monitor antibiotic residues in food products.

According to Decision of the Council of the Eurasian Economic Commission No. 94, if the permissible content of antibiotics in food products is exceeded, the laboratory must preserve control samples for 3 months without changing their characteristics and composition. In order to meet these requirements, it is necessary to select optimal sample storage conditions. This is especially important for  $\beta$ -lactam antibiotics, since they are not very stable [2].

The purpose of this work was to study the stability of beta-lactam antibiotics (6 compounds) in chicken meat under various storage conditions: at temperatures of +4, -20, -86 °C without refreezing the samples and at -20 °C with re-freezing, and also when boiling at +80 °C

Sample preparation and determination were based on GOST 34137 and 34533. Substances were extracted using liquid-liquid extraction with acetonitrile followed by purification with hexane. Determination was carried out by HPLC-MS/MS. The technique provided good reproducibility ( $sr \leq 18\%$ ). The matrix effect for various substances was in the range of 74-116%, and the detection limits were 5  $\mu\text{g}/\text{kg}$  for ampicillin and 1  $\mu\text{g}/\text{kg}$  for the remaining compounds.

It has been established that when boiled for an hour, the content of antibiotics in minced chicken decreases by 55.2-96.7%. When stored at positive temperature, beta-lactam antibiotics are stable for no more than 3 weeks. When stored at -20 °C, by week 15 the concentration drops to 17-76.2% of the initial value for various compounds. Periodic thawing/freezing has a significant effect only on cefotaxime, which is the least stable of all the antibiotics tested. Storage at -86°C has been shown to provide stability for  $\beta$ -lactams for at least 15 weeks, with the exception of cefotaxime. Accordingly, these conditions are best suited to meet the EEC requirements.

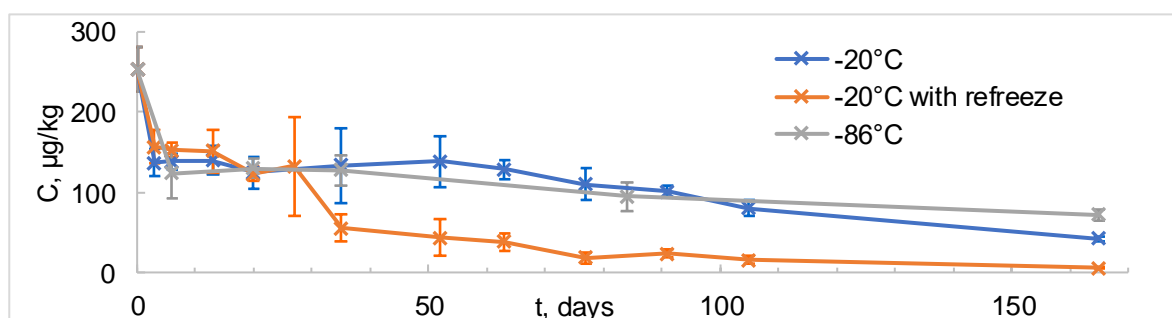

**Figure 1.** Cefotaxime concentrations in chicken meat samples stored at different temperatures

### References

- [1] Caneschi A. et al. *The Use of Antibiotics and Antimicrobial Resistance in Veterinary Medicine, a Complex Phenomenon: A Narrative Review* // *Antibiotics*. MDPI, **2023**. Vol. 12, № 3.
- [2] Freitas A., Barbosa J., Ramos F. *Determination of Amoxicillin Stability in Chicken Meat by Liquid Chromatography-Tandem Mass Spectrometry* // *Food Anal Methods*. **2012**. Vol. 5, № 3. P. 471–479.

### Acknowledgements

This work was supported by the Russian Federal Centre for Animal Health.

## CHARACTERISATION OF THE COMPONENT COMPOSITION OF BREWING HOP VARIETIES USING HPLC-HRMS AND MOLECULAR NETWORKS

*Vasileva E.N.<sup>1</sup>, Ikhlaynen Y.A.<sup>1</sup>, Rodin I.A.<sup>1</sup>*

<sup>1</sup> M.V. Lomonosov Moscow State University, Moscow, Russia  
Student

[elizaveta.vasileva@chemistry.msu.ru](mailto:elizaveta.vasileva@chemistry.msu.ru)

Hops (*Humulus lupulus L.*) are perennial climbing plants of the *Cannabaceae* family cultivated by humans. The main consumer of hops is the food industry: hops are one of the main components of beer, used as a flavouring and preservative. The diversity of brewing hop varieties and technological approaches in brewing creates the possibility of forming unique flavour and aroma properties of beer products. In addition, hops are a common component of bioactive additives. The unique profile of biological activity of this plant is formed by the variety of its secondary metabolites, which include alpha-, beta-bitter acids and flavonoids [1]. The most informative approach for the analysis of plant raw materials is the use of hybrid methods of analysis, especially chromatography-mass spectrometry. The main tool in the analysis of biologically active components of hops and products based on it is HPLC-MS in the version with reversed-phase chromatographic separation, and the informativeness of the analysis increases significantly with the use of high-resolution mass analyzers with the possibility of obtaining fragmentation spectra [2]. In the case of plants, the main challenge in characterizing the metabolome is the low informativeness of databases for both individual components and chromatographic-mass spectrometric characteristics of compounds, which necessitates the use of additional tools for identifying unknown components. One such strategy is the use of molecular networks, to analyze the fragmentation spectra of component samples.

The aim of the present work was to characterize the metabolome of brewing hop varieties based on the results of sample analysis by HPLC-HRMS and further visualization of experimental data by means of automatic mass chromatogram marking and molecular networking. The object of the study was samples of pelletized brewing hops, from which methanol extracts were prepared using ultrasonic treatment to enhance analyte extraction. The analyses were carried out on HPLC-MS with an orbital-ion trap mass analyzer in a data-dependent fragmentation spectra accumulation mode. The obtained data underwent chromatographic peak labelling and filtering procedures, after which molecular networks linking components close in structure to the fragmentation spectra were constructed using the GNPS service. The resulting molecular networks were then analyzed. The components were identified based on the set of observed fragments, retention information, comparison with databases and literature sources.

Based on the results, more than 50 components of the studied extracts were characterized, including proposed structures for compounds not previously described in the literature. The present work demonstrates the efficiency of using molecular networks in the characterization of complex samples.

### References

- [1] Journal of Agricultural and Food Chemistry, 2016, 64, 7789-7799
- [2] *Metabolomics*, 2012, 8, 492-507

# SILICA NANODOTS AS LUMINESCENT REAGENTS FOR THE DETERMINATION OF CATECHOLAMINES

*Vasilyeva A.A.<sup>1</sup>, Fokina A.S.<sup>1</sup>, Gorbunova M.V.<sup>1</sup>, Apyari V.V.<sup>1</sup>*

<sup>1</sup>Department of Chemistry, Lomonosov Moscow State University, Leninskie gory, 1/3, Moscow 119991, Russia  
Student

[6490351@gmail.com](mailto:6490351@gmail.com)

Nanoscale particles have long established themselves as promising materials for analytical chemistry purposes. In particular, silica nanodots, due to a number of their properties, are becoming an increasingly studied tool to determine various substances: inorganic, organic compounds, as well as biologically active substances [1]. Catecholamines belong to one of the important groups of biologically active substances. There is a large number of different methods for determining these substances using metal nanoparticles, but there are practically no works devoted to the use of silica nanodots for solving this task [2,3].

The purpose of this work is to study the features of the interaction of silica nanodots with catecholamines and to evaluate its possibilities for the luminescent determination of catecholamines.

As a result of the interaction of nanodots with catecholamines, the shapes of the excitation and luminescence spectra change. In the case of dopamine, the luminescence intensity decreases at 445 nm. When nanodots interact with norepinephrine and epinephrine, a maximum at 500 – 510 nm is observed in addition to reducing the luminescence intensity at 445 nm, for norepinephrine this effect being observed at lower concentrations than in the case of epinephrine.

The conditions for the luminescent determination of norepinephrine, epinephrine and dopamine using silica nanodots (SiNDs) were selected: pH 10 – 10.5, V(SiNDs) = 1.00 ml ( $V_{\text{total}} = 5.00$  ml), the interaction time of SiNDs with dopamine is 20 min (when heated to 40°C), norepinephrine – 30 min, epinephrine – 60 min. The detection limits for norepinephrine, epinephrine and dopamine are 0.1  $\mu\text{M}$ , 0.7  $\mu\text{M}$  and 2  $\mu\text{M}$ , respectively.

By the example of norepinephrine, the analytical characteristics of the determination of catecholamines using SiNDs synthesized using glucose and ascorbic acid as reductants were compared. It has been shown that the lower detection limits are achieved by the interaction of catecholamines with SiNDs prepared in the presence of ascorbic acid.

The influence of foreign components was studied by the example of norepinephrine. It was shown that equimolar amounts of common inorganic ions ( $\text{Na}^+$ ,  $\text{K}^+$ ,  $\text{Mg}^{2+}$ ,  $\text{Cl}^-$ ,  $\text{SO}_4^{2-}$ ,  $\text{NO}_3^-$ ) do not interfere with the determination whereas  $\text{Cu}^{2+}$  ions interfere. The presence of L-methionine, L-glutamine,  $\beta$ -alanine, glycerin, calcium gluconate, and glucose does not interfere with the determination of norepinephrine in a ratio of 1:1000, and DL-serine and L-histidine in a ratio of 1:100.

The analysis of the drugs "Dopamine-Ferein" ("Bryntsalov-A", Russia), "Epinephrine Hydrochloride – Vial" (VIAL, China) and "Noradrenaline" ("Ecofarmplus", Russia) was carried out. The results of the fluorimetric determination using SiNDs are in good agreement with the data of HPLC analysis.

## References

- [1] Vasilyeva A.A., Buribaev R.A., Gorbunova M.V., Apyari V.V., Torocheshnikova I.I., Dmitrienko S.G. Silicon-based nanoparticles: Synthesis and recent applications in chemical sensing. // *TrAC Trends Analyt. Chem.* 2024. Article 117538. DOI: 10.1016/j.trac.2024.117538
- [2] Ahmed J., Faisal M., Harraz F.A., Jalalah M., Alsareii S.A. Development of an amperometric biosensor for dopamine using novel mesoporous silicon nanoparticles fabricated via a facile stain etching approach. // *Phys. E: Low-Dimens. Syst. Nanostructures.* 2022. V. 135. Article 114952. DOI: 10.1016/j.physe.2021.114952
- [3] Qaisi R.M., Akhdhar A., Choi J.-W., El-Said W.A. A photoluminescence sensor for in-situ monitoring of the dopamine neurotransmitters released from PC12 cells. // *Spectrochim. Acta - A: Mol. Biomol. Spectrosc.* 2023. V. 287. Article 122109. DOI: 10.1016/j.saa.2022.122109

## Acknowledgements

This study was supported by the Russian Science Foundation, grant N 24-23-20004.

This research was performed according to the Development program of the Interdisciplinary Scientific and Educational School of Lomonosov Moscow State University «The future of the planet and global environmental change». The research was carried out under partial support of MSU Shared Research Equipment Centers "Technologies for obtaining new nanostructured materials and their complex study" and "Nanochemistry and nanomaterials", National Project "Science" and MSU Program of Development.

THE NEW GENERATION OF GREEN SOLVENTS FOR THE EXTRACTION OF  
**B** GROUP VITAMINS FROM FOODS

*Veselova D.S., Barbayanov K.A., Timofeeva I.I., Bulatov A.V.*

St. Petersburg State University, St. Petersburg, Russia

Student

[daraveselova9@gmail.com](mailto:daraveselova9@gmail.com)

**B** group vitamins are necessary substances for human and animal health, they are water soluble and are found in many foods. This group of vitamins are widely used in cosmetology, pharmaceutical and food industry. Deficiency of **B** vitamins can cause inflammation of various types, anemia, diabetes. Excessive and uncontrolled consumption of these substances can also lead to serious problems with the gastrointestinal tract, harm the central nervous system and negatively affect the state of the body [1]. Thus, today the regulation of the content of **B** vitamins in various food products is a relevant task.

Food samples have complex matrices, therefore usually require pretreatment step for the isolation and often preconcentration of target analytes. Thus, acid, base and enzymatic hydrolysis can be used for the destruction of the sample matrices, and liquid liquid extraction as well as solid phase extraction are applied for the concentration of vitamins [2]. Frequently, liquid liquid extraction turns out to be simpler and cheaper than solid phase extraction. However, much attention is paid to the extractant. Historically, "classical" solvents such as alcohols, carboxylic acids, aldehydes, etc. have been used for this type of extraction. Though, green extractants such as terpenoids, deep eutectic solvents, etc. have recently become popular. In this work, we compared the extraction abilities of "classical" and "green" solvents by evaluating the distribution coefficients of analytes between the aqueous and organic phases. The phases were analyzed by high-performance liquid chromatography with UV-detection.

#### References

[1] *Journal of Healthy Nutrition and Dietetics* **2018**, *8*, 74

[2] *J. Chromatogr. A.* **2003**, *1007*, 77

#### Acknowledgements

This project was finally supported by the Russian Science Foundation (project no. № 24-23-00052, <https://rscf.ru/project/24-23-00052/>).

# THE INTERFERING EFFECT OF DEEP EUTECTIC SOLVENTS ON THE DETERMINATION OF FLAVONOIDS IN PLANTS MATERIALS

*Yatsyshina V.S.<sup>1</sup>, Shishov A.Y.<sup>1</sup>, Nizov E.R.<sup>1</sup>*

<sup>1</sup> St. Petersburg State University, St. Petersburg, Russia

Student

[st107503@student.spbu.ru](mailto:st107503@student.spbu.ru)

Flavonoids are a group of polyphenolic compounds, which have a number of useful properties including antiviral, anti-inflammatory, cardioprotective, antidiabetic, anti-cancer, which are still being actively studied [1]. Due to the biological activity and all the advantages of flavonoids, there is an analytical task for their extraction and determination. One of the widely used methods for determining the total flavonoid content in plant extracts is photometric analysis with aluminum chloride, where  $Al^{3+}$  is used as a complexing agent [2].

Organic solvents or aqueous solutions are usually used to extract flavonoids from plant raw materials, however, in modern analytical chemistry deep eutectic solvents are increasingly used to extract BAS from plant raw materials. It is possible that some components of DES, for example, acids or alcohols, can form stable complexes with aluminum or bind to the flavonoids, thereby interfering with the course of the main spectrophotometric reaction and reducing/overestimating the analytical signal. Since there is still no general approach to the spectrophotometric determination of flavonoids using DES, the purpose of this work was to find out whether these DES consisting of choline chloride as an acceptor of hydrogen bonds and different classes of compounds (alcohol, sugars, urea and acids) as donors have an interfering effect and, if there is such an effect, to propose elimination options, as well as to conduct a spectrophotometric analysis of real samples using DES.

In this study, a photometric reaction was carried out under optimal conditions with various DES additives in such concentrations as can be expected when extracting flavonoids from plant raw materials (10-100 g/l) and the interfering effect of DES was counted. As a result, it was shown that in the entire studied range of DES concentrations, the use of DES in the determination of flavonoids without any additional procedures or without taking into account the interfering effect is not possible. Ways to eliminate the interfering influence were investigated, first of all, the acidity of the solutions. It is known that flavonoids in an alkaline medium are capable of forming colored forms, while a bathochromic shift in the absorption spectrum is also observed. Thus, the analysis procedure was simplified and the effect of pH on the spectral characteristics of both the rutin-aluminum complex and pure rutin was investigated. Finally, the analysis was carried out by changing the pH of the extract solution, without the addition of aluminum chloride. Total flavonoid content in three herbs - primula, hypericum and pyrola – was determined using the proposed method. The results of the analysis were compared with the results obtained by using the standard method with the addition of  $AlCl_3$ .

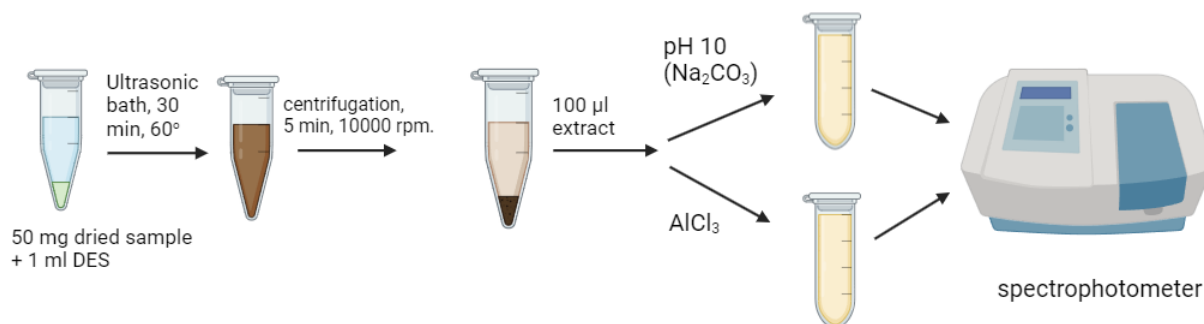

**Scheme 1.** Analysis of plant raw materials.

## References

- [1] *Food Chemistry* **2022**, 383, 132531
- [2] *Academic press* **2021**, 150, 111932

## Acknowledgements

This work was supported by the Russian Science Foundation (project No 22-73-10039). Scientific research was performed using the equipment of the Research Park of St. Petersburg State University (Chemical Analysis and Materials Research Centre).



# EXPLORING THE PROPERTIES OF DEEP EUTECTIC SOLVENTS USING INDUCTANCE COIL HIGH-FREQUENCY CONTACTLESS SENSOR

*Yuskina E.A.<sup>1</sup>, Shishov A.Y.<sup>1</sup>, Panchuk V.V.<sup>1,2</sup>, Kirsanov D.O.<sup>1</sup>*

<sup>1</sup> St. Petersburg State University, Department of Analytical Chemistry, St. Petersburg, Russia

<sup>2</sup> Institute for Analytical Instrumentation RAS, St. Petersburg, Russia

Student

[yuskina.k@yandex.ru](mailto:yuskina.k@yandex.ru)

Deep eutectic solvents (DES) are compounds that consist of two or more components which are capable of self-association, often by hydrogen bonding, resulting in a eutectic mixture with a melting point lower than that of each original component. These solvents exhibit non-volatility, high thermal stability, and the ability to dissolve a wide range of organic and inorganic substances. They are considered “green” and inexpensive substitutes for ionic liquids. DES have recently appeared in analytical practice but have already found a broad range of applications; mainly as effective extractants [1]. An effective tailoring of DES properties (such as viscosity, conductivity, water content) to the requirements of a particular analytical task requires fast and simple methods for a numerical assessment of such properties.

Recently, we have proposed a new type of contactless sensors based on the of high-frequency conductometry method [2,3]. The sensor consists of three simple components: an alternator (2-112 MHz), an inductance coil and a receiver (Fig.1). Once the sample is placed in the inductance coil, it becomes its core and changes the current flowing through the coil. The response spectrum for each particular sample is recorded, with the resulting signal depending in complex ways on the dielectric constant, magnetic properties, capacitance characteristics and conductivity of the sample. To date, it has been shown that the influence of these parameters on the analytical signal provides additional information about the sample compared to simple conductometric measurements. The resulting spectra are processed by chemometric methods to extract information.

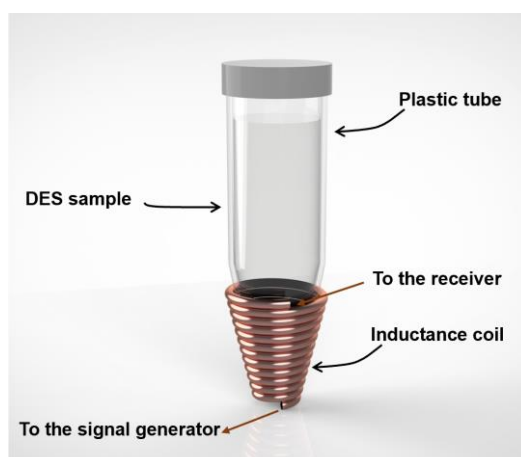

**Figure 1.** 3D model of the inductance coil [4].

In this study we focused on the assessment of water content in DES using this contactless sensor. DES based on choline chloride and 3 alcohols (ethylene glycol, propylene glycol, glycerol) and 3 acids (malonic, malic, tartaric) were analyzed. The attained detection range of water content was approximately from 5% to 20% w/w. Phase diagrams for two different DES of choline chloride-urea and thymol-menthol were also obtained using the developed sensor. Furthermore, sensor response time is less than 100 ms, which allows monitoring the process of DES formation in the dynamic mode. The details on these studies will be provided in the presentation along with the discussion on possible perspectives of the device.

## References

- [1] *Trends in Analytical Chemistry* **2020**, 129, 115956
- [2] *Electrochemistry, Past and Present* **1989**, 390, 441
- [3] *Anal.Chem.* **2022**, 94(35), 11982
- [3] *Measurement* **2024**, 232, 114716

## Acknowledgements

This work was supported by the Russian Science Foundation (project No 23-23-00114).

# HYDROGEN BOND STRENGTH AND PHASE TRANSITION IN PYRIDINIUM-BASED IONIC LIQUIDS AS VIEWED BY SOLID-STATE $^2\text{H}$ NMR

*Zhalnina T.V.*<sup>1</sup>, *Khudozhitkov A.E.*<sup>1,2</sup>, *Kolokolov D.I.*<sup>1,2</sup>

<sup>1</sup> Novosibirsk State University, Novosibirsk, Russia

<sup>2</sup> Borekov Institute of Catalysis, Novosibirsk, Russia  
Student

[t.zhalnina@g.nsu.ru](mailto:t.zhalnina@g.nsu.ru)

Ionic liquids are considered to be prominent candidates for electrolyte material in electrochemical devices. High conductivity, stability, low vapor pressure and melting temperature are the qualities that are sought for by researchers in this field. Moreover, the type of solid-liquid phase transition is of great interest. Some ionic liquids crystallize upon cooling, whereas others undergo vitrification. The vitrifying ionic liquids can exhibit the pronounced mobility of ions at the temperatures below melting point, which is beneficial for conductivity. Therefore, it is interesting to find out how various modifications of ionic liquid structure impacts the melting process.

In this contribution we present ionic liquids based on carboxyalkyl pyridinium cation  $[\text{Py}-(\text{CH}_2)_n\text{-COOH}]^+$  ( $n=1, 2, 4, 6, 7, 9$ ) and bis(trifluoromethanesulfonyl)imide anion  $[\text{NTf}_2]^-$  (Scheme 1). These ionic liquids show relatively low melting temperature and therefore are interesting for electrochemical applications. The variation of the hydroxyalkyl chain length of cation provides opportunity to adjust the magnitude of dispersive interaction between ions. These changes may have the impact on the melting transition. Moreover, the hydrogen bond strength can alter as well.

We apply the solid state  $^2\text{H}$  NMR spectroscopy in order to characterize the strength and mobility of hydrogen bond between carboxyl group (cation is deuterated in carboxylic group) of cation and anion. The value of the quadrupole constant of deuterium correlates with the strength of the hydrogen bond (decreases for stronger hydrogen bond) [1].  $^2\text{H}$  NMR spectra consist of two signals in the solid state indicating at the possibility of various surrounding of deuterium and, therefore, the presence of different hydrogen bond types.

The transition of the  $^2\text{H}$  NMR spectrum from broad anisotropic pattern (typical for solid state) to the isotropic pattern (liquid state) unambiguously shows the melting transition. The evolution of the spectrum with temperature indicates at the type of the melting transition (liquid – crystal or liquid – glass). We show that the melting temperature varies with the length of carboxyalkyl chain only for the  $n < 5$ . Further increase of the carboxyalkyl chain does not lead to the shift of the melting temperature.

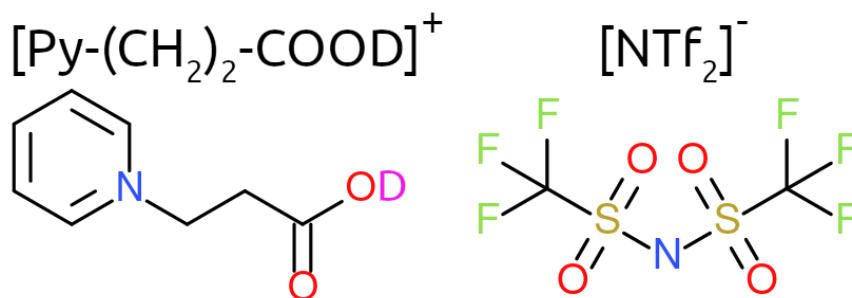

**Scheme 1.** Structure of  $[\text{Py}-(\text{CH}_2)_2\text{-COOD}][\text{NTf}_2]$ .

## References

[1] *J. Chem. Phys.* **1981**, *74*, 4791–4799

## Acknowledgements

This work was supported by the Russian Science Foundation (project No 24-13-00129).

# THE SYNTHESIS OF NANOPARTICLES AND THE PHASE FORMATION IN THE LAPO<sub>4</sub>-GDPO<sub>4</sub>-YPO<sub>4</sub>-(*n*H<sub>2</sub>O) SYSTEM UNDER SOFT CHEMISTRY METHODS

*Zhidomorova Ksenia Alekseevna*<sup>1,2</sup>, *Enikeeva Maria Olegovna*<sup>2,3</sup>

<sup>1</sup> Saint-Petersburg State Technological University (Technical University), Department of Physical Chemistry, Saint-Petersburg, Russia

<sup>2</sup> Institute of Silicate Chemistry, Russian Academy of Sciences, Saint-Petersburg, Russia

<sup>3</sup> Ioffe Physical-Technical Institute of the Russian Academy of Sciences, Saint-Petersburg, Russia

The 4th-year bachelor student

[zhidomorovak@gmail.com](mailto:zhidomorovak@gmail.com)

Interest in the synthesis and creation of multifunctional nanomaterials is constantly growing, including for materials based on rare earth element (REE) orthophosphates. Due to their 4*f*-electron configuration, their compounds possess a wide range of functional properties: magnetic, luminescent, catalytic, thermal insulation, etc. Nanoparticles based on various REE compounds have found application for solving a number of problems, for example, in medicine as bioluminescent labels [1], in optoelectronics - to create laser materials, scintillators, light-transforming substances [2] or organic light-emitting diodes [3]. Soft chemistry techniques are commonly referred to as chemical methods for obtaining nanodisperse materials, which involve minimal use of high temperatures and pressures in the synthesis of solid-phase materials. There are precipitation, hydro- or solvothermal synthesis, microwave-hydrothermal synthesis, liquid-phase sol-gel synthesis, and others. Using soft chemistry methods and optimal synthesis conditions, particle size, morphology and crystallinity can be controlled. In addition, this ways to synthesis can produce not only thermodynamically stable but also metastable phases, which makes it possible to analyse the process of phase formation in the system and predict the properties of objects.

Compounds with monazite and xenotime structures are perspective materials for creation of heat-resistant and luminescent materials [4] and for immobilisation of radioactive waste [5]. This work is focused on the preparation of nanoparticles using soft chemistry methods, determination of the conditions for the formation of phases with rhabdophane and xenotime structures and the influence of pH on average crystallite sizes and structure parameters of nanoparticles.

The synthesis of nanocrystalline materials was performed by precipitation method by adding a thin stream of NH<sub>4</sub>H<sub>2</sub>PO<sub>4</sub> solution to the solution of REE nitrates. The obtained suspension with pH=1 and pH=10 was mixed on a magnetic stirrer for 15 minutes. The experimental procedure included three ways to change the pH of the suspension solution: 1) addition of aqueous ammonia solution to the initial solution of NH<sub>4</sub>H<sub>2</sub>PO<sub>4</sub>, 2) addition of aqueous ammonia solution to the prepared suspension formed at the stage of NH<sub>4</sub>H<sub>2</sub>PO<sub>4</sub> solution addition, 3) addition of ammonia solution to the initial solutions of REE nitrates and NH<sub>4</sub>H<sub>2</sub>PO<sub>4</sub>. After precipitation, the reaction products were sedimented by centrifugation and washed with distilled water to pH=7, dried at T=80 °C and ground in the agate mortar.

The obtained nanocrystalline materials were investigated by X-ray powder diffraction, scanning electron microscopy (SEM) with energy-dispersive X-ray spectroscopy (EDXS). Diffractograms were processed using the Rietveld method, the average crystallite size was calculated using the Scherrer and Halder-Wagner formulas.

## References

- [1] *Appl. Spectrosc. Rev.* **2005**, 40(1), 1-31
- [2] *J. Photochem. Photobiol.* **2004**, 5(3), 183-202
- [3] *Coord. Chem. Rev.* **2005**, 249(21-22), 2489-2509
- [4] *Crit. Rev. Solid State Mater. Sci.* **2014**, 39(6), 459–479
- [5] *J. Hazard. Mater.* **2012**, 235-236, 17-28

## Acknowledgements

The work was supported by Russian Science Foundation (RSF) (project No. 24-13-00445).

# DEVELOPMENT OF SAMPLE PREPARATION METHODS AT ATMOSPHERIC PRESSURE FOR DETERMINATION OF RARE EARTH ELEMENTS IN ROCKS BY INDUCTIVELY COUPLED PLASMA MASS SPECTROMETRY

*Zhilkina A.V., Kolotov V.P., Tyurin D.A., Gromyak I.N. Sibrina M.A.*

Vernadsky Institute of Geochemistry and Analytical Chemistry of Russian Academy of Sciences,  
Moscow, Russia  
Researcher  
[avzhilkina@gmail.com](mailto:avzhilkina@gmail.com)

The study of rocks and the processes of their formation provides an opportunity to approach the understanding of the history of geological evolution of the Earth's crust, and to relate different geological events. Rare earth elements (REE) act as geochemical indicators reflecting the degree of melt fractionation. Therefore, the correct interpretation of geochemical data requires reliability and accuracy of the results of elemental analysis of the studied rocks.

Inductively coupled plasma mass spectrometry (ICP-MS) is now the leading method for the determination of trace elements. The application of this method in bulk analysis involves samples dissolution. Over the last 50 years, many methods for digestion of geologic samples have been proposed. Practice has shown that due to the diversity of rocks and the uniqueness of their mineral composition, it is not possible to create a single, unified approach for all types of rocks.

The aim of the work is to develop a set of solutions for obtaining reliable information on the content of REE and other elements in rocks of different types by ICP-MS method with the results uncertainty of no more than 5%.

A hardware complex for acid decomposition of geological objects at atmospheric pressure has been developed and manufactured. Acid digestion procedures for the developed hardware complex have been formulated [1]. The developed procedures have been tested using different types of certified reference material (CRM): basalt types - BCR-2 (USGS, USA); BIR-1 (USGS, USA); BHVO-2 (USGS, USA) [1]; granite - GS-N (ANRT, France); urtite (nepheline syenite class)- MW-3 (IGEM; CRM:GSO 2123-81, Russia); serpentinite - UB-N (ANRT, France) and olivine-rich meymechite [2] - DVM (RIAP; CRM:GSO 4317-88, Russia). The elemental composition of the samples was determined by ICP-MS and ICP-AES methods. The obtained results of analysis were compared both with certified CRM values and with the updated data published in the GeoReM database (Max Planck Institute, Germany). The results of REE and other elements determination in basalts (BCR -2, BHVO-2, BIR-1), granites (GS-N), serpentinite (UB-N) [1] and meymechite (DVM) [3] have been published.

Analysis of the data showed underestimation of the results for REE (from 10% and up) and some other elements for CRM granite (GS-N) and urtite (MW-3). In the case of CRM (GS-N) it is related with the fact that the rock contains hard-to-digest minerals. To increase the accuracy of granite analysis the method of solid-phase fluorination (with  $\text{NH}_4\text{HF}_2$ ) followed by acid decomposition at atmospheric pressure in the developed hardware complex was developed. It is shown that the use of this method of sample preparation provides metrologically reliable results for REE determination.

In the case of urtite CRM (MW-3), the presence of high content of Al in the sample leads to the formation of hard-soluble fluorides in the process of acid decomposition, which entails the co-crystallization of trace elements [4], and as a consequence, underestimation of the analysis results. Based on the data of the article [4] it is confirmed that Mg addition noticeably improves the results of REE determination. Due to the absence of the majority of elements in the certificate of CRM MW-3, including REE, the method of CRM decomposition was additionally tested using autoclaves, after which the analysis results were compared with each other. The obtained REE contents can be used as a reference for analyzing rocks of urtite group.

## References

- [1] Kolotov et al. A new approach to sample mineralization in an open system for the analysis of geological samples by inductively coupled plasma mass spectrometry with improved performance characteristics. *Journal of Analytical Chem.* **2020**, №75 (5), pp.569-581
- [2] Govindaraju K. 1994 Compilation of working values and sample description for 383 geostandards. *Geostandards Newsletter.* **1994**, 18, 1581
- [3] Zhilkina et al. Determination of rare earth elements in a standard sample of Russian Far Eastern meymechite by ICP-MS. The 2-nd international conference on technologies, properties and applications of rare metals and related materials (RAREMET-2022). Moscow, **2022**, pp.258-260
- [4] Cotta A.J. et al. Classical and new procedures of whole rock dissolution for trace elements determination by ICP-MS. *Geostandards and Geoanalytical Research.* **2011**, №36, pp.27-50

# COMPARATIVE STUDY OF POLY(DIALLYLDIMETHYLAMMONIUM CHLORIDE) AND CHITOSAN AS PHYSICALLY ADSORBED COATINGS FOR ELECTROPHORETIC SEPARATION OF BIOLOGICALLY ACTIVE COMPOUNDS

Ziangirova E.R.<sup>1</sup>, Kolobova E.A.<sup>1</sup>, Solovyeva E.V.<sup>1</sup>, Kartsova L.A.<sup>1</sup>

<sup>1</sup> St. Petersburg State University, St. Petersburg, Russia  
Student

[st097674@student.spbu.ru](mailto:st097674@student.spbu.ru)

Capillary electrophoresis (CE) is a rapid method for the separation of charged and neutral analytes. However, there are some limitations of the method related to low sensitivity, selectivity and insufficient reproducibility of analyte migration parameters. This problem can be solved by applying various modifiers of electrophoretic systems for formation of coatings on the quartz capillary walls.

The creation of coatings can be carried out in two ways: by forming of covalent bonds, as well as, by physical adsorption. The latter method is characterized by simplicity of implementation. To form dense and stable coatings, the modifier must have a high density of functional groups, be adsorbed on the quartz surface and effectively shield silanol groups. Polyelectrolytes poly(diallyldimethylammonium chloride) (PDDA) and chitosan are studied as modifiers in this work (Scheme 1).

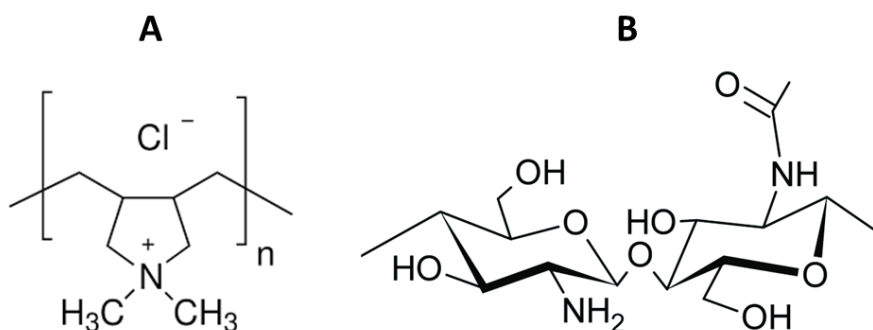

Scheme 1. Structure of PDDA (A) and chitosan (B)

PDDA is characterized by high molecular weight, its charge is independent of pH. It is widely used for the separation of inorganic anions [1] and short-chain fatty acids [2], as well as in the formation of multilayer coatings involving anionic polyelectrolytes for the separation of proteins [3].

Chitosan, on the other hand, is a less studied modifier compared to PDDA. Due to the presence of amino and hydroxy groups, it is able to interact with analytes through the formation of hydrogen bonds. Moreover, chitosan can act as a chiral selector due to presence of chiral centers in carbohydrates fragments.

Thus, the aim of this study is to investigate analytical capabilities of chitosan based coatings at separation biologically active analytes and to compare results with PDDA as well-known modifiers of the capillary inner surface.

The procedures of coatings formation for both polyelectrolytes were proposed. The obtained coatings were tested in the separation of analytes of different polarity: catecholamines, amino acids and carboxylic acids. It was found that in the case of catecholamines and amino acids, the PDDA-based coatings provided higher efficiency. However, for organic acids, chitosan allowed achieving higher values of separation selectivity and resolution.

One of the features of chitosan, unlike PDDA, is the presence of multiple chiral centers. Coatings based on it together (2-hydroxypropyl-β-cyclodextrin) in background electrolyte (double chiral system) provided separation of β-blockers enantiomers with high values enantioselectivity.

## References

- [1] *Journal of Chromatography A* **2014**, 1365, 226.
- [2] *J Anal Chem* **2023**, 78, 361.
- [3] *Capillary Electrophoresis of Biomolecules. Methods in Molecular Biology*, **2013**, 984.

## Acknowledgements

This work was supported by the Russian Science Foundation (project № 24-13-00378).



# **ABSENTEE PARTICIPANTS**

## SORPTION OF Pd(II), Co(II), Ni(II) IONS ON A SYNTHETIC SORBENT WITH A FRAGMENT OF ETHYLENEDIAMINE CHLORIDE

Abilova U.M., Alieva F.S., Gadzhieva S.R., Chiragov F.M.

Baku State University, AZ1148, Baku,  
academician Zahid Khalilov street - 23  
e-mail: [u.abilova@mail.ru](mailto:u.abilova@mail.ru)

It is known from the literature that the efficiency of extracting microelements from solutions using polymer complex-forming sorbents using the sorption concentration method is relevant<sup>1-3</sup>. Since the method is convenient for the subsequent determination of the studied elements by various methods of analysis. For this purpose, based on a matrix of maleic anhydride with styrene, a chelating sorbent with an ethylenediamine chloride fragment was synthesized. The sorbent was identified using IR spectroscopy. The sorption of ions Pd(II), Co(II), Ni(II) on the surface of the sorbent was studied. During preliminary concentration, the dependence of the degree of sorption of Pd(II), Co(II), Ni(II) ions on time was studied and it was found that sorption equilibrium occurs within 30 minutes and thereafter practically does not change. The results of sorption studies are shown in the table:

**Table 1. Results of studies of sorption of Pd(II), Co(II), Ni(II) ions**

Metals	Optimal, pH	Ionic strength, mol/l *	Maximum sorption capacity, mg/g	Optimal eluent
Co(II)	5	0,6	723	0,5 HCl
Ni(II)	5	0,8	451	0,5H <sub>2</sub> SO <sub>4</sub>
Pd(II)	4	0.8	640	0.5HCl

\*-  $\mu$  value, which contributes to a significant reduction in the degree of sorption

The developed method was used for the determination of Pd(II), Co(II), Ni(II) in catalysts based on sibunites. The results were verified by flame atomic absorption spectrometry.

**References**

1. G. R. Anpilogova, L. A. Baeva, Bulletin of the Bashkir University. 2020. T. 25. No. 3 pp. 554-550
2. Parfenova Victoria Valerievna abstract. dis. ...cand. chem. Sci. St. Petersburg, 2018. 22 p.
3. Koroleva Elena Anatolyevna Dis. ...cand. chem. Sciences: 02.00.02 Kursk, 2002 172 p.

## DEVELOPMENT OF A GC-MS/MS METHOD FOR ANALYSIS OF ENERGY-SATURATED COMPOUNDS

*Danilova D.A.<sup>1</sup>, Ignatovich Z.V.<sup>2</sup>, Rogachev A.A.<sup>2</sup>*<sup>1</sup>Scientific and Practical Centre of The State Forensic Examination Committee of The Republic of Belarus, Minsk, Belarus<sup>2</sup>Institute of Chemistry of New Materials of the National Academy of Sciences of Belarus, Minsk, Belarus

PhD student

[danilovad11@gmail.com](mailto:danilovad11@gmail.com)

Due to the increase in terrorist threats, the relevance of research devoted to the determination of energy-saturated compounds is increasing. A common method for detecting such compounds is gas chromatography with a mass spectrometric detector [1]. Recently, considerable attention has been paid to the development of methods for the analysis using a tandem mass detector. This technique allows to select an ion of interest (the precursor ion), subject it to further dissociation, and then capture one of the resulting ions (the product ion). To effectively detect compounds, it is necessary to select the precursor ion→product ion transitions used in the multiple reaction monitoring (MRM) mode. Although a large number of works are devoted to determination of energy-saturated compounds in various matrices [2], insufficient attention is paid to the development of the MRM method for electron ionization.

This work is aimed at developing the parameters of the MRM method for the analysis of the following compounds: 2,4,6-trinitrotoluene, 2,4,6-trinitro-N-methyl-N-nitroaniline, 1,3-dinitrobenzene, 1,4-dinitrobenzene, picric acid, 2,4-dinitrophenol. Agilent 7890B gas chromatograph with a Xevo TQ-GC triple quadrupole mass selective detector were used. The temperature gradient of the thermostat, the helium flow rate, the temperature of the injector, the interface line and the ion source were selected. From the obtained chromatograms, the mass spectrum of compounds was extracted. The most intense ions were selected for further fragmentation. Mass spectra were recorded at various energies in the collision cell. The energy in the collision cell was chosen for each of the precursor ions to obtain the highest intensity of the ion current. After fragmentation the product ions were analyzed. Based on the fragmentation of precursor ions MRM transitions were formed and used to record chromatograms in MRM mode. The GC-MS/MS method demonstrates effectiveness in the determination of substances in complex matrices at the trace level. The sensitivity of the determination increases due to a significant reduction in noise (Figure 1).

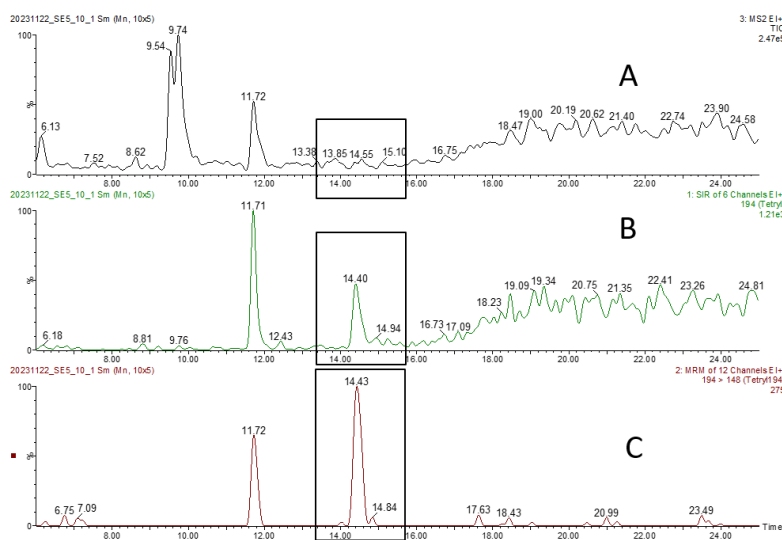

**Figure 1.** Chromatograms of trace amounts of 2,4,6-trinitro-N-methyl-N-nitroaniline: total ion current (A), selected ion monitoring  $m/z$  194 (B), MRM-transition 194→148 (C).

## References

- [1] *Explosives* **2000**, 2762  
 [2] *Toxics* **2021**, 9, 60



DESCRIBING DIVERSITY OF MICROCYSTINS IN *MICROCYSTIS SP.* CELL CULTURE BY COMBINATION OF LC-HRMS WITH MOLECULAR NETWORKING

Ikhlaynen Y.A.<sup>1</sup>, Rodin I.A.<sup>1</sup>, Zorina A.A.<sup>2</sup>, Sinetova M.A.<sup>2</sup>, Klychnikov O.I.<sup>1</sup>,

<sup>1</sup> M.V. Lomonosov Moscow State University, Moscow, Russia

<sup>2</sup> K.A. Timiryazev Institute of Plant Physiology, Russian Academy of Sciences, Moscow, Russia  
[ikh.ya@yandex.ru](mailto:ikh.ya@yandex.ru)

Microcystins are the most widespread class of cyanotoxins and the one that has most often been implicated in cyanobacterial poisoning which is common issue during blooming processes. One of the main challenges in studying and monitoring microcystins is the great structural diversity within the class. Since 1980s more than 300 microcystins have been reported with different degree of structure evaluation. Main techniques for microcystins characterization are tandem mass spectrometry coupled to liquids chromatography (LC-MS/MS) and nuclear magnetic resonance spectroscopy (NMR). In cases of compounds low abundance or inability for preparative separation, LC-MS/MS becomes powerful tool for investigation of unknown's molecule's structure, due to high informativity of microcystins's positive ions fragmentation spectra. Moreover, usage of high-resolution mass-spectrometry (HRMS) in combination with fragmentation data analysis tools, such as molecular networking, simplifies the establishment of the putative structure as LC-HRMS data is often to complicated for manual analysis.

The aim of present work was to describe microcystins profile in *Microcystis sp. cell* cultures and evaluate the effectiveness of molecular networking in the process of unknown compounds identification. In this study we analyzed cell cultures derived from *Microcystis samples* gained at South China Sea (IPPAS B-2074). Cells were growing in BG-11 liquid and then were collected by centrifugation. Samples were then extracted using ultrasonic bath and concentrated on reversed phase solid-phase extraction cartridges. Samples were analyzed on HPLC-MS with an orbital-ion trap mass analyzer in a data-dependent fragmentation spectra accumulation mode with reversed-phase column-based separation. Several MS-detection conditions were applied in order to gain most informative dataset. Then, peak picking and alignment steps were performed, along with fragmentation spectra cluterization and database search. Resulting data was analyzed with GNPS service for molecular networks construction with different settings. Then, manual analysis of molecular networks was performed. In order to simplify the identification of unknowns, theoretical  $m/z$  values for common peptide fragments were generated using in-house R script.

As a result, conditions for molecular networking-based experiments in microcystins analysis were optimized. More than 50 microcystins, including previously unreported were found in analyzed samples. Present work demonstrates the efficiency of molecular networking in the analysis of complex mixtures.

### Acknowledgements

Work was funded by grant № 21-74-30003

## INFLUENCE OF AGING PROCESSES ON INK CLUSTERING

*Kechin A. A., Androsova A. V., Kartsova L. A*

Saint Petersburg State University,  
Institute of Chemistry, Saint Petersburg, Russia  
Student, 2nd year of Master's program  
[kechin.ars@icloud.com](mailto:kechin.ars@icloud.com)

Determining the age of a document through ink analysis is an important issue in forensic science, since current analysis methods do not always accurately date the handwriting. The main method of dating the examined writing is through analyzing changes in the chemical composition of the ink matrix that occur when the writing substance comes into contact with the paper.

Ink consists of dyes, solvents, resins, and other compounds added to alter ink properties. Dyes and solvents are the most promising analytes, as their mass content is significantly higher than other components, and the processes that occur with them on paper (molecule breakdown for dyes, evaporation for solvents) are easier to analyze [1].

The most popular analytical methods for ink analysis are chromatographic methods due to their high efficiency and reproducibility of results. Gas chromatography (GC) with mass spectrometric detection is used for solvent analysis, and high-performance liquid chromatography (HPLC) with spectrophotometric detection is used for dye determination [2].

To assess the influence of natural (ink stored for a long time under room conditions) and artificial (ink exposed to UV light) aging on the clustering of blue ballpoint pen inks, hierarchical cluster analysis was applied. The relative areas of chromatographic peaks were used as initial data.

As part of this work, a sample preparation scheme was developed. Experiments were conducted to determine the most reproducible method of cutting out a paper fragment, to identify the most effective extraction system, and to study the effect of pressure on a ballpoint pen.

Finally, to improve the clustering accuracy, a special series of experiments on GC analysis of solvents in the matrices of the examined inks were conducted. Combining GC and HPLC data analysis increased inter-cluster distance, thus separating samples of blue ballpoint pens with similar dye compositions.

### References

- [1] *Forensic Sci. Int.* **2010**, 197 (1-3), 1-20
- [2] *Vib. Spectrosc.* **2006**, 40 (2), 270-277

### Acknowledgements

The work was supported by Russian Science Foundation (project No 22-23-00577).

## IMPORTANT ASPECTS OF SECONDARY RAW MATERIALS ANALYTICAL CONTROL BASED ON ELECTRONIC WASTE COMPOUND EXAMINATION

*Makarova A.I., Filichkina V.A.<sup>1</sup>*

<sup>1</sup> National University of Science and Technology «MISIS», Moscow, Russia

Postgraduate student

[makarova@anacon-exp.ru](mailto:makarova@anacon-exp.ru)

Low production cost of precious metals, extracted from secondary raw materials, in comparison with traditional methods, combined with dramatic price increase for pure precious metals, force to pay more attention to alternative ways of precious metals production. Among them, using electronic waste (e-waste) as a source of precious metals, looks encouraging. E-waste is complex, multicomponent source of precious metals, which turnover rapidly increasing, due to excessive consumption of electronic and electric devices. This factor makes e-waste to become a renewable source of precious metals globally.

In Russia electronic waste already considered as an alternative source of precious metal extraction. For instance, printed circuit board (PCB) and copper, collected from e-waste are sent to recycling plants, where copper cathodes are produced from these raw materials, and precious metals are also recovered. The precious metals obtained because of technological metallurgical processes are sent to specialized refineries.

Based on chemical analysis, electronic waste shall be considered as heterogeneous, polymetallic source of precious metals which contains variety of elements with mass fraction from 0.001 to 40 %. The most valuable elements for production are: gold, silver, platinum, palladium and rhodium.

Technology of precious metals production from e-waste shall be developed to maximize an effect at every level of e-waste recycling process. The effect shall be measured by laboratory tests of multiple samples, collected from recycling process. The set of laboratory samples for chemical analysis, produced from initial sample, are used for a precious metal mass fraction analysis. Calculation accuracy highly depends on process of collecting samples, further process of sample preparation and ways of conducting chemical analysis. Considering that Russian government services control business of precious metals, it is important to develop standard method of quantitative chemical analysis of secondary raw materials.

While analytical control of pure precious metals, concentration in ore or alloys is widely used and well standardized, there is no any state standard to measure concentration of precious metals in e-waste materials. There are 15 (fifteen) certified methodologies to quantify concentration of a precious metal which can be applied to e-waste materials but all of them are confidential with limited public access due to commercial secret. Brief examination shows that spectral analysis seems to have the largest potential due to focus on process of chemical preparation laboratory samples from secondary raw materials [1].

The purpose of the article is to develop standard spectral based method of measuring precious metals concentration in e-waste with preliminary assay concentration of the sample.

We determine the following major steps of the method:

- preparing initial sample from 1 to 5 mm by material crushing and attrition
- thermal treatment
- sample decomposition
- testing and processing of results.

Since shape of areas of gold as well as it's distribution along e-waste sample highly influence measurement tolerance, we are examining optimal conditions of test samples preparation. A close look shall be taken to the initial and final fractions of samples, crushing & attrition modes. Results accuracy in depend on various factors was examined by using Isikawa diagram. For these purposes, a stock of material is created for the further production of certified reference material, which will be prepared using the developed technology and used as a reference for testing subsequent stages of the method.

### References

[1] Yu A Karpov. Analytical testing of noble metals: Collective monograph. **2019**, 23-68.

DEVELOPMENT OF CALIBRATION CURVES FOR DETERMINING THE ELEMENTAL  
COMPOSITION OF ELECTRICAL STEEL BY GLOW DISCHARGE ATOMIC EMISSION  
SPECTROMETRY METHOD

*Maltseva V.O.<sup>1</sup>, Lepilina M.Yu.<sup>2</sup>, Yakubenko E.V.<sup>2</sup>, Ermolaeva T.N.<sup>1</sup>, Farafonova O.V.<sup>1</sup>*

<sup>1</sup> Lipetsk State Technical University, Lipetsk, Russia

<sup>2</sup> Novolipetsk Metallurgical Plant, Lipetsk, Russia

Student

[viktoria040401@yandex.ru](mailto:viktoria040401@yandex.ru)

Due to the development of new coatings for rolled electrical steel and the development of their application technology, the need to assess the following parameters increases: coating thickness, its chemical composition and morphology of surface layers. The most popular and rapid method of layer-by-layer coating analysis is the method of glow discharge optical emission spectrometry (GD OES). When analyzing coatings by the calibration curve method, the results of quantitative determination of the composition of electrical steel samples depend on the conditions for its preparation using a set of reference material (RM) with a known composition of impurities, the excitation conditions of low-temperature argon plasma, and the influence of matrix components. Due to the lack of universal requirements in the literature for the construction of calibration curves for determining the concentrations of Al, carbon, Cr, Mn, sulfur, Si in the analysis of samples of rolled products by the GD OES method, it is important to study the features of establishing functional dependencies of the emission intensities of the normalized elements on their concentration.

A glow discharge spectrometer GD Profiler-2 (Horiba Scientific, France) was used in the work. The uniformity of cathode etching was assessed using a profilometer (HOMMEL ETAMIC T8000, Germany). To select the operating parameters of the glow discharge plasma, the power was varied in the range of 10-90 V in 10 V increments and the pressure in the range of 100-950 Pa in 100 Pa increments. In the study of RM, the uniformity of cathode etching at a pressure of 850 Pa and a power of 100 V was confirmed. A pulse mode with a pulse frequency of 400 Hz is recommended for measuring production samples of rolled steel.

The calibration dependences of the emission intensity (I, B) on the concentration (C, %) of the type  $I = a \cdot C + b$  were constructed taking into account the relative spray velocity after measuring 40 reference steel samples. The Quantum spectrometer software allows you to automatically calculate the parameters of the calibration function using the weighted least squares method, which converts the equation to the form:

$$I = \frac{\sum_{i=1}^N (\omega_i \cdot \bar{I}_i \cdot (C_i - \sum_{i=1}^N (\omega_i \cdot C_i)))}{\sum_{i=1}^N (\omega_i \cdot (C_i - \sum_{i=1}^N (\omega_i \cdot C_i)))} \cdot C - \frac{\sum_{i=1}^N (\omega_i \cdot \bar{I}_i \cdot (C_i - \sum_{i=1}^N (\omega_i \cdot C_i)))}{\sum_{i=1}^N (\omega_i \cdot (C_i - \sum_{i=1}^N (\omega_i \cdot C_i)))} \cdot \sum_{i=1}^N (\omega_i \cdot C_i) + \sum_{i=1}^N (\omega_i \cdot \bar{I}_i).$$

Therefore, for each point of the calibration curve, the weight  $\omega_i$  was calculated using the formula:  $\omega_i = n_i / (\sigma_i(c))^2$ , where  $n_i$  is the number of measurements ( $n=6$ ). The main components of uncertainty ( $\sigma_i(c)$ ) are: the standart deviation of the certified composition ( $\sigma_{CRM}$ ), the standard deviation of the measured average intensity ( $\sigma(I)$ ), constant term, representing the minimum uncertainty in determination of a composition for the spectral line used ( $\sigma_{DL}$ ) and the coefficient of dispersion ( $k_1 = \frac{\delta C}{\delta I}$ ). Using the software, the uncertainty was calculated using the equation:

$$\sqrt{\sigma_{CRM}^2 + \sigma_{DL}^2 + (k_1 \sigma(I))^2}.$$

The expediency of taking into account the interelement influence by adding a free term automatically calculated by Quantum to the calibration function: carbon ( $H=-0,37$  V), sulfur ( $Ca=-1,47$  V), Si ( $Pb=-3,66$  V). The results of the evaluation of the standart deviation calibration characteristics before (s) and after (s') adjustments, performed in accordance with the requirements of MI 2175-91, confirmed the improvement in the precision of the determination Al (s=0,37; s'=0,26), carbon (s=0,50; s'=0,39), Cr (s=0,14; s'=0,09), Mn (s=0,15; s'=0,08), sulfur (s=1,05; s'=0,61), Si (s=0,13; s'=0,02). The graphs are linear ( $R^2=0,993-0,999$ ) in the ranges of determined concentrations of Al, carbon, Cr, Mn, sulfur, % by weight.: 0,0015-0,514; 0,0023-0,92; 0,008-1,82; 0,01-2,1; 0,0019-0,067. However, it is advisable to determine the Si concentration using a second-order polynomial equation with  $R^2=0,999$ .

The precision of determining the concentration of Al, carbon, Cr, Mn, sulfur, Si in CO according to the obtained calibration functions was confirmed by the Student's criterion. There is a decrease in the ratio error in determining the concentration ( $\Delta C$ ) of carbon, sulfur and Si by 1,3-4 times.

ORGANIC-INORGANIC HYBRIDS OF LAYERED PEROVSKITES: ENHANCING  
PHOTOCATALYTIC ACTIVITY THROUGH INTERCALATION AND GRAFTING

*Morocho D.S.<sup>1</sup>, Minich I.A.<sup>1</sup>*

<sup>1</sup> St. Petersburg State University, St. Petersburg, Russia  
Student, bachelor's degree  
[st101391@student.spbu.ru](mailto:st101391@student.spbu.ru)

Over the past few decades, layered perovskites have garnered tremendous scientific interest in the fields of materials science and chemistry, offering a variety of structures and properties that are applicable across numerous disciplines. Recently, Nb-based layered perovskites have become of great interest as active photocatalysts because they are wide bandgap semiconductors able to produce hole (h<sup>+</sup>) electron (e<sup>-</sup>) pairs under UV irradiation. The photoinduced hole electron pairs subsequently take part in the photocatalytic reactions such as overall water splitting into H<sub>2</sub> and O<sub>2</sub>, fixation of CO<sub>2</sub>, photodegradation of hazardous organics, etc. [1]

Herein to the work, KCa<sub>2</sub>Nb<sub>3</sub>O<sub>10</sub> was selected as the host for intercalation of a wide variety of organic molecules. As we know KCa<sub>2</sub>Nb<sub>3</sub>O<sub>10</sub> and HCa<sub>2</sub>Nb<sub>3</sub>O<sub>10</sub> are lamellar Dion Jacobson compounds that consist of perovskite slabs interleaved by potassium cations or protons and water molecules. Their low charge density and low interlayer covalency, relative to the structurally related Ruddlesden Popper and Aurivillius phases, make them readily amenable to interlayer space modification as, for example, ion exchange (protonation), intercalation, grafting and exfoliation reactions.

In the present work, primary attention is paid to the intercalation of bulky organic molecules (TBAOH, TMAOH) and grafting with phenols and naphthols into the perovskite slabs of HCa<sub>2</sub>Nb<sub>3</sub>O<sub>10</sub> to develop organic-inorganic hybrids and nanosheets with enhanced photocatalytic activity and in some cases visible light absorbance. The resulting materials were systematically analyzed by XRD, FTIR spectroscopy, thermogravimetric and elemental analysis, diffuse reflectance spectroscopy and scanning electron microscopy (SEM) in detail.

### References

[1] *J. Mater. Chem.*, 2001, 11, 1277-1282

### Acknowledgements

This work was supported by the St. Petersburg State University resource center.

DETERMINATION OF POLYCYCLIC AROMATIC HYDROCARBONS IN SOILS USING  
QUECHERS TECHNIQUE AND DISPERSIVE LIQUID-LIQUID MICROEXTRACTION

Ovsepyan S.K., Chervonnaya T.A., Musorina T.N., Temerdashev Z.A.

Kuban State University, Krasnodar, Russia

Postgraduate

[suzannadd7@mail.ru](mailto:suzannadd7@mail.ru)

An important task in the field of ecotoxicology is the development of effective and environmentally friendly methods for determining persistent organic pollutants in real samples. Researchers are highly interested in dispersive liquid-liquid microextraction (DLLME) methods, which contribute to the miniaturization of the extraction process, reduction of the volume of toxic extractants, and concentration of analytes [1, 2]. DLLME is often combined with other modern sample preparation methods of various compositions. For the analysis of solid samples, including soils, the use of the QuEChERS technique for the preliminary extraction of analytes from a complex matrix is promising. The combination of QuEChERS and DLLME techniques will reduce the influence of matrix effects and increase the preconcentration factors of analytes, which is of particular interest.

In this study, the possibility of using a binary mixture of acetone and dichloromethane as an extractant and silica gel as a sorbent for purification was investigated. During the DLLME stage, the effectiveness of adding a mixture of chloroform and acetonitrile in various ratios to the obtained extract, as well as non-polar hexane, was studied to improve the dispersibility of the extraction system. The results showed low efficiency of such additional procedures for analyte extraction. For concentration, traditional separation of dichloromethane from acetone in an aqueous environment (n-DLLME procedure) was preferred. The optimal volume of water for the proposed concentration method was determined. The analysis of the separated chloroorganic extract drop was carried out using gas chromatography-mass spectrometry in the selective ion monitoring mode on the "Shimadzu GCMS-QP 2020" instrument. The combination of the described techniques allowed for the extraction of priority PAHs of different structures from soils with high humus content with high efficiency (above 80%). The application of dispersive liquid-liquid microextraction technique in soil sample preparation for analysis may contribute not only to analyte concentration but also to additional purification of the obtained extracts by transferring more polar interfering matrix components into the dispersant phase.

#### References

- [1] *Trends Anal. Chem.* **2018**, *108*, 167
- [2] *J. Anal. Chem.* **2020**, *75*, 1237

#### Acknowledgements

The work was supported by Ministry of Science and Higher Education of the Russian Federation [ FZEN-2023-0006].

NEW TECHNIQUES FOR CONCENTRATES-EMITTERS PREPARATION IN X-RAY  
FLUORESCENCE ANALYSIS FOR THE DETERMINATION OF LANTHANIDES

*Prokopenko Y.R.*<sup>1</sup>

<sup>1</sup> D. Mendeleev University of Chemical Technology of Russia, department of analytical chemistry, Moscow,  
Russia

Graduate student

[prokopenko.i.r@muctr.ru](mailto:prokopenko.i.r@muctr.ru)

The efficiency of determination of lanthanides by coprecipitation from solutions in the form of their chelates with different organic reagents (arsenazo III-type, 8-oxyquinolin-type reagents, etc.) has been studied.

In general, 2 systems of coprecipitation have been investigated. One involved the introduction of an organic cationic dye to block the groups that give solubility to the chelate (arsenazo III-type reagents), with the addition of an indifferent film-forming coprecipitant. In another system (derivatives of 8-hydroxyquinoline), only an indifferent coprecipitant was added. This technique ensures that almost all amount of analyzed elements will precipitate. All used indifferent film-forming coprecipitants allowed to prepare a solid-phase concentrate with an adjustable layer thickness and flat surface [1].

The effectiveness of polyvinylbutiral (PVB) and BF-6 glue in the coprecipitation procedure in various analytical systems was compared, and according to the results of the experiments, the optimal variant of preconcentration by coprecipitation with organic reagents using indifferent film-forming coprecipitants was selected. The use of BF-6 glue, which contains polyvinylbutiral as well as phenolformaldehyde resin, has proven to be preferable due to the higher mechanical stability of the concentrate, improved surface quality of the emitter and signal-to-background ratio. The use of this technique makes it possible to achieve a concentration coefficient of  $10^5$  and significantly lower the LOD. The multi-element nature of the XRF in relation to lanthanides in this case makes it possible to fully use high selectivity in determining these elements in liquid environmental objects.

#### References

[1] Kuznetsov, V.V., Shalimova, E.G., Agudin, P.S., and Bespalov, E.L., *RF Patent 2623194*, **2017**.

[2] Prokopenko Y.R., Kuznetsov V.V. *Comparison efficiency of bisazosubstituted chromotropic acid reagents at rare earth elements pre-concentration by coprecipitation in x-ray fluorescence spectroscopy // Advances in chemistry and chemical technology. – 2022. – V. 36, № 8(257). – P. 61-64.*

## COMBINATION OF ATR IR SPECTROSCOPY WITH CHEMOMETRIC APPROACHES FOR CLASSIFICATION OF III GENERATION CEPHALOSPORINS ANTIBIOTICS

Shabunina A.Yu., Rusanova T.Yu.

Saratov State University, Saratov, Russia

Master's student, 2nd year of study

E-mail: [kalinichenkoau@mail.ru](mailto:kalinichenkoau@mail.ru)

Antibiotics are a common and extremely important type of antibacterial agent: they can either kill or inhibit the growth of bacteria. However, the excessive consumption of antibiotics, their release into the environment, and the need to control drugs make the definition and identification of antibiotics relevant for the purposes of the pharmaceutical, food industry, and agriculture. There are spectral, chromatographic and electrochemical methods for the qualitative and quantitative determination of antibiotics in various media. Combinations of chemometric and spectral methods for the determination of cephalosporin antibiotics have been described in the literature [1-2], but the full potential of this approach has not been realized. The purpose of this work is to evaluate the possibility of using ATR IR spectroscopy in combination with chemometric algorithms for the identification of certain cephalosporin antibiotics.

The object of the study were representatives of the third generation of cephalosporins in the form of powders for injection: cefotaxime, manufacturers: Biokhimik JSC, Russia, Saransk; JSC "LEKO", Russia, Vladimir region; DEKO COMPANY LLC, Russia, Moscow; ceftazidime, manufacturers: Rapharma JSC, Russia, Lipetsk region; PJSC Kraspharma, Russia, Krasnoyarsk; JSC "Sintez", Russia, Kurgan; ceftriaxon, manufacturers: Shreya Life Sciences Pvt Ltd, India; JSC "Biokhimik" Russia, Saransk; JSC "Rapharma" Russia, Lipetsk region; JSC "Sintez", Russia, Kurgan; JSC "LEKO", Russia, Vladimir region; PJSC Kraspharma, Russia, Krasnoyarsk; OJSC "Borisov Plant of Medical Preparations", Republic of Belarus, Borisov.

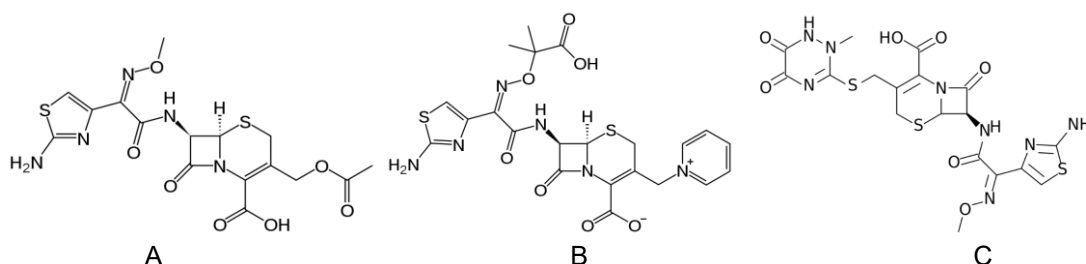

**Fig. 1.** Structural formulas of the molecules cefotaxime (A), ceftazidime (B), ceftriaxone (C)

The IR spectra of these medicinal substances were recorded using an FT-801 Fourier transform IR spectrometer with a universal attenuated total internal reflection (ATR) attachment. The spectral bands were found to have similar bands in the spectra, making drug identification difficult. For classification, the principal component analysis, the k-means clustering, and the algomerative hierarchical clustering were used. Processing was carried out using Microsoft Excel with the XLSTAT add-in.

The results of three chemometric approaches are the identification of three main classes of substances: cefotaxime, ceftazidime, ceftriaxone.

### References

- [1] *Futur J Pharm Sci.* **2018**, 4(2), 241.  
 [2] *Spectrochim Acta A.* **2019**, 219, 436

### Acknowledgements

This work was supported by the Russian Science Foundation (project 24-23-00519).



A NEW APPROACH TO MONITORING THE QUALITY OF EQUIPMENT CLEANING FROM  
"FEBUXOSTAT"*Tuyakova S.G., Mikhailchenkov M.V., Kurgachev D.A.*

Tomsk State University, Tomsk, Russia

Master's Student

[tuyakova123@gmail.com](mailto:tuyakova123@gmail.com)

In many pharmaceutical companies, the number of production lines is limited and the same equipment is used to produce different drugs. Therefore, controlling the cleanliness of the production line remains an important drug quality and safety control issue.

FDA recommends the use of direct sampling method from the surface of the equipment (swab method) for residue analysis [1]. Currently, commercially available swabs are used which do not provide complete extraction, so the results are always underestimated.

In this work, we propose to use polymeric porous polyester material as swabs. Polyester swabs manufactured by us optimize sample preparation due to the absence of the stage of re-extraction of the substance from the cotton swab into solution.

The analysis was carried out by UV- HPLC method.

According to the analysis results, the extraction degree for our polyester swab was 83%, for cellulose swab – 57%.

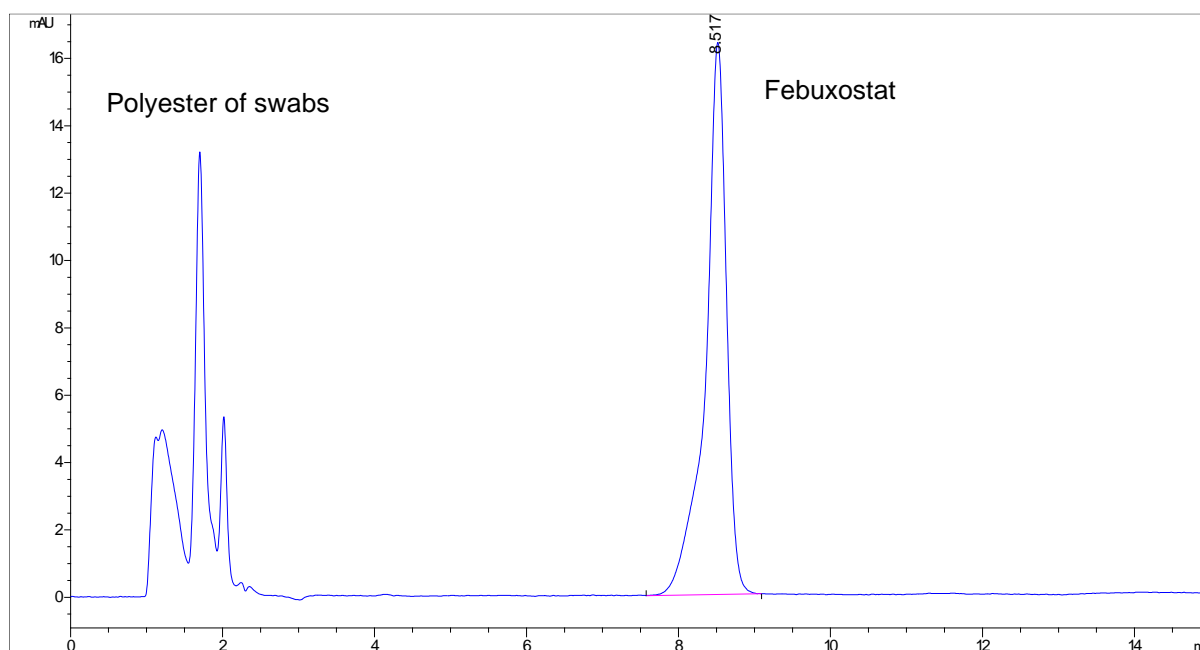

**Scheme 1.** Chromatogram of a polyester swab sample.

The use of polyester swabs reduces analysis time without compromising the quantification of surface residues.

### References

[1] Pure Food: Securing the Federal Food and Drugs Act of 1906/Young, James H Princeton.// N.J: Princeton University Press, 1989. – P. 98.

THE EFFECT OF THE MOBILE PHASE ADDITIVES ON FRAGMENTATION PATHWAYS IN THE ANALYSIS OF OCTOGEN (HMX) AND HEXOGEN (RDX) BY HIGH-PERFORMANCE LIQUID CHROMATOGRAPHY WITH MASS-SPECTROMETRY

*Varabyova V.V.<sup>1,2</sup>, Zuraev A.V.<sup>1</sup>*

<sup>1</sup> Belarus State University, Minsk, Belarus

<sup>2</sup> Scientific and Practical Centre of The State Forensic Examination Committee of The Republic of Belarus, Minsk, Belarus

PhD Student

[viktoryia.vorobyova@gmail.com](mailto:viktoryia.vorobyova@gmail.com)

The problems of detection and identification of high-energy substances are covered by numerous scientific studies [1,2]. The main focus of which is the development of methods with a low detection limit and high selectivity. The high-performance liquid chromatography/mass spectrometry (HPLC/MS) can solve these problems. The capabilities of the method make it possible to detect energetic compounds at qualitative and quantitative levels. Tandem use with a mass spectrometric detector allows one to achieve a high level of reliability of the results obtained. However, the performance of this method can be reduced if unsuitable mobile phases are chosen, as well as additives.

This study is focused on identifying the impact of mobile phase additives on the performance of HPLC/MS in the detection of HMX and RDX. During the experimental study, the only variable parameter in a series of analyzes was the composition of the aqueous eluent (the presence or absence of modifying additives). This study assessed the influence of modifiers such as formic acid (HCOOH), ammonium acetate (CH<sub>3</sub>COONH<sub>4</sub>), ammonium nitrate (NH<sub>4</sub>NO<sub>3</sub>), as well as their absence in the eluent.

In the process of mass spectrometric fragmentation with negative-ion electrospray ionization of HMX and RDX, produced spectra are usually characterized by highly abundant adduct ions and the absence of molecular anions. This is an important difference between fragmentation process of nitramines and nitroaromatic compounds. Adduct ions such as [M+Cl]<sup>-</sup>, [M+CH<sub>2</sub>(OH)COO]<sup>-</sup> appeared even without adding the corresponding additives to the eluent, and their origin was explained by the presence of impurities in the solvents or eluents.

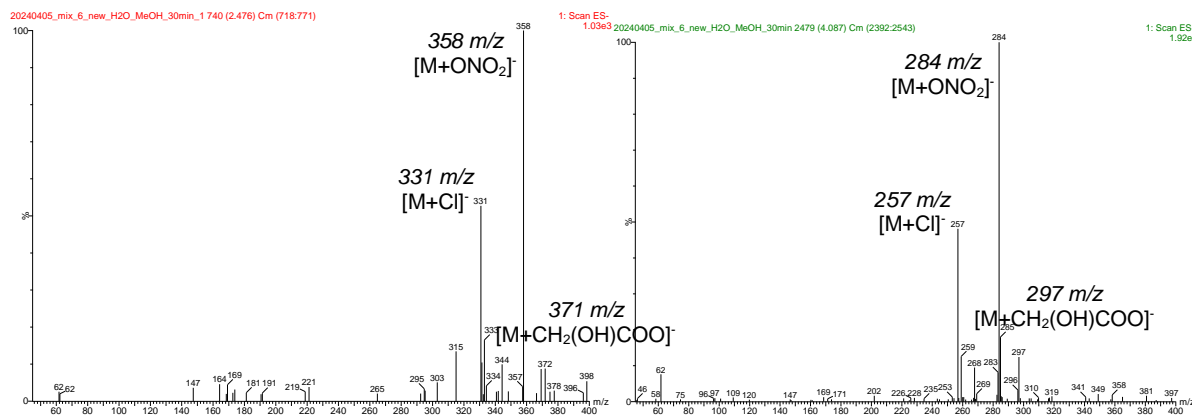

**Scheme 1.** Mass spectra of HMX and RDX with no additives in the eluent.

Generally, the study of differences in ionization efficiencies and fragmentation pathways of HMX and RDX allowed us to conclude that mass spectra of RDX and HMX are very similar and in both spectra [M-H]<sup>-</sup> ions are extremely rare or completely absent. Presumably, the most abundant ions [M+ONO<sub>2</sub>]<sup>-</sup> can be formed by part of the RDX/HMX molecules decomposing yielding ONO<sub>2</sub><sup>-</sup> species which in turn cluster with a second RDX/HMX molecule producing abundant [M+ONO<sub>2</sub>]<sup>-</sup> cluster ions.

### References

- [1] *Rapid Commun. Mass Spectrom.* **2005**, *19*, 99;  
 [2] *Analytical Sciences* **2016**, *32*, 611.

## MICROEXTRACTION PRE-CONCENTRATION OF STEROID HORMONES USING IONIC LIQUIDS

*Vasilenko M.<sup>1</sup>, Araslanova A.T.<sup>1</sup>, Bessonova E.A.<sup>1</sup>, Kartsova L.A.<sup>1</sup>*

<sup>1</sup> St. Petersburg State University, St. Petersburg, Russia  
Student

[st112828@student.spbu.ru](mailto:st112828@student.spbu.ru)

The identified analytes are sex steroid hormones, which are biologically active substances that play an important role in regulating various metabolic processes in humans and animals. The analogues of natural steroid hormones - synthetic steroid drugs are used for the treatment of a number of diseases associated with endocrine pathologies. The control of the content of natural and synthetic steroids is an important task for both clinical medicine and ecological monitoring of environmental objects primarily natural waters. However, it is difficult to chromatographically separate natural and synthetic hormones due to their close chemical structure, low levels of steroid hormone concentrations in real objects (ng/ml) require the development of highly sensitive and selective approaches to their extraction, concentration and determination. Current trends in the development and evolution of sample preparation methods include miniaturization, a combination of liquid and solid-phase microextraction, and the search for new selective and environmentally friendly extractants. Special attention is paid to ionic liquids (IL) as extractants, due to their unique physicochemical properties.

The purpose of this study is to identify the analytical capabilities of imidazolium ions for the extraction and concentration of steroid hormones from natural objects by methods of dispersion liquid microextraction (JJME and magnetic solid-phase microextraction (TFME) for their subsequent determination by HPLC. The conditions for their separation by reverse-phase HPLC with diode-matrix detection were found on model systems of steroid hormones (estrogens, progesterone and testosterone). The possibilities of hydrophobic imidazole-based ionic liquids with various anions and alkyl radical lengths (1-butyl-3-methylimidazolium hexafluorophosphate ([C4MIM][PF6]), 1-hexyl-3-methylimidazolium bis(trifluoromethylsulfonyl)imide ([C6MIM][NTf2]), 1-hexyl-3-methylimidazolium tetrafluoroborate ([C6MIM][BF4]) and 1-methyl-3-octylimidazolium tetrafluoroborate ([C8MIM][BF4]) as extractants under the conditions of DLLME and SPME. The factors influencing the degree of analyte extraction (the content of IL and dispersing solvent, the pH value of the sample matrix, salt addition, extraction time, etc.) were established and optimized using the design of the experiment. The best results in terms of steroid extraction degrees were obtained for IL [C6MIM][NTf2] as an extractant under conditions of DLLME with vortex dispersion; the extraction recovery was 65-98%. Magnetic NPs based on magnetite coated with silica gel have been synthesized for magnetic SPME. The possibilities of IL [C8MIM][BF4] as a magnetic LNPs modifier providing high recovery of steroid also have been revealed. The possibility of determining steroids in selected conditions in natural objects is shown. The found mode is adapted to the analysis of real objects (natural water bodies).

**Acknowledgements**

The authors of the work express their gratitude to the Resource Centers "Methods of Substance Composition Analysis" and "Nanotechnology" of the St. Petersburg State University Science Park for the equipment provided and the research carried out.

THE APPLICATION OF PHTHALYLGLYCYL CHLORIDE FOR AMINO ACIDS AND BIOGENIC AMINES DERIVATIZATION

*Zorina M.O.*<sup>1</sup>, *Temerdashev A.Z.*<sup>1</sup>, *Feng Y.-Q.*<sup>2</sup>, *Dotsenko V.V.*<sup>1</sup>, *Nesterenko P.N.*<sup>3</sup>, *Ioutsi V.A.*<sup>4</sup>, *Zhurkina K.A.*<sup>1</sup>

<sup>1</sup> Kuban State University, Analytical Chemistry Department, Krasnodar, Russia

<sup>2</sup> Wuhan Textile University, School of Bioengineering and Health, Wuhan, China

<sup>3</sup> Lomonosov Moscow State University, Moscow, Russia

<sup>4</sup> Endocrinology Research Centre, Moscow, Russia

PhD Student

[zorinaamaria@gmail.com](mailto:zorinaamaria@gmail.com)

Amino acids and biogenic amines, which include catecholamines (epinephrine, norepinephrine and dopamine), serotonin and histamine, play a major role for clinical diagnostics of various diseases. For example, amino acids are used as biomarkers in newborn screening for inherited metabolic disorders [1], and dopamine is known as a major biomarker of Parkinson's disease [2].

Several analytical methods can be applied for the determination of amino acids and biogenic amines in various biological matrices. To date, reversed-phase HPLC-MS becomes the most commonly used method due to its high sensitivity and rapidity [3]. Given the polarity of analytes, the application of this method requires derivatization, which allows to introduce a non-polar fragment into molecules. A lot of derivatization reagents, such as dansyl chloride (DNS-Cl), ortho-phthalaldehyde (OPA), 9-fluorenyl-methyloxycarbonyl chloride (FMOC-Cl) and others, have been developed for derivatization of amino group of various biogenic compounds. These reagents have a number of disadvantages, including inability to derivatize secondary amino groups due to steric hindrance, long reaction time and instability of derivatives in aqueous solutions. Since a load on clinical diagnostic laboratories are increasing due to annual population growth and it is necessary to develop more sensitive methods for the determination of biogenic compounds in biological matrices in order to improve the quality of diagnosis of various diseases, development of new derivatization reagents to overcome above mentioned disadvantages is needed.

The application of phthalylglycyl chloride (PG-Cl) for derivatization of amino acids and catecholamines is discussed in this work. This reagent is widely used in organic synthesis, so its prevalence and availability make it a convenient candidate for the role of potential derivatization reagent. The derivatization scheme is shown in Fig. 1.

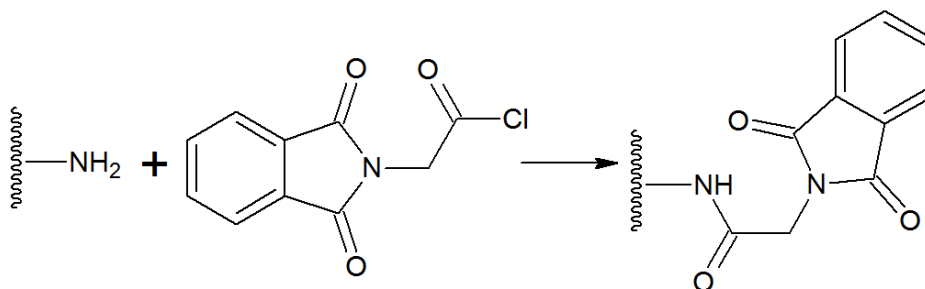

**Figure 1.** The scheme of amino group derivatization with phthalylglycyl chloride

Analysis of real urine samples was performed by UHPLC-HRMS method. The efficiency of amino acids and catecholamines derivatization with PG-Cl, DNS-Cl, OPA, FMOC-Cl was evaluated. The proposed approaches may be promising for further research.

#### References

- [1] *Ann Pediatr Endocrinol Metab.* **2015**, *20*, 119  
 [2] *Transl Neurodegener.* **2023**, *12*, 44  
 [3] *Analyst* **2015**, *140*, 1965

#### Acknowledgements

This research was funded by Russian Science Foundation (project No 24-43-00003) and by National Natural Science Foundation of China (22361132526), using the scientific equipment of the Center for Environmental Analysis at the Kuban State University (unique identifier RFMEFI59317X0008).



# **ORGANIC, ORGANOMETALLIC AND MEDICINAL CHEMISTRY**



# **KEYNOTE & INVITED SPEAKERS**

## KEYNOTE SPEAKER



**Dr. Sci., Prof. Leonid Fershtat**

*N.D. Zelinsky Institute of Organic Chemistry Russian Academy of Sciences, Moscow, Russia*

**Nitrogen-Oxygen Heterocyclic Systems: Novel Synthetic Approaches and Emerging Trends**

## INVITED SPEAKERS

**Dr. Sci., Prof. Dmitry Perekalin**

*A.N. Nesmeyanov Institute of Organoelement Compounds of Russian Academy of Sciences, Moscow, Russia*

**Synthesis of Chiral Boranes by Asymmetric Insertion of Diazoacetates into B-H Bonds**



**Dr. Sci., Prof. Dmitry Dar'in**

*Saint Petersburg State University, Saint Petersburg, Russia*

**New Ligands of the Ubiquitin Ligase Cereblon for Targeted Proteasomal Protein Degradation**

**Assoc. Prof. Alexander Bunev**

*Head of the Medicinal Chemistry Centre, Togliatti State University, Togliatti, Russia*

**FEP-Based Design of Cereblon Ligands in Bifunctional Degradation Development**



## NITROGEN-OXYGEN HETEROCYCLIC SYSTEMS: NOVEL SYNTHETIC APPROACHES AND EMERGING TRENDS

*Fershtat L.L.*

N.D. Zelinsky Institute of Organic Chemistry, Russian Academy of Sciences, Moscow, Russia  
Head of Laboratory of Nitrogen Compounds, Dr. Sci.

[fershtat@ioc.ac.ru](mailto:fershtat@ioc.ac.ru)

State-of-the-art science advances necessitate a constant search for new organic materials with improved applied properties. From the point of view of the molecular structure of such organic materials, one of the most promising classes of compounds are conjugated polyheteroatom heterocyclic systems. As a rule, such structures have a number of advantages, including high thermal stability, an ability to stabilize the unpaired electron and a set of balanced physicochemical and functional properties. A broad potential of organic molecular systems constructed on the basis of nitrogen heterocycles explains their multipurpose use for various applications. Therefore, the development of new approaches to the oriented design of polynitrogen heterocyclic systems remains highly relevant.

Herein, we present the latest achievements of our scientific group in the development of new methods for the synthesis of various nitrogen-oxygen heterocyclic structures. Over the past 5 years, we aimed to create promising synthetic strategies for the assembly of various nitroazoles, as well as related heterocyclic systems, which include 1,2,5-oxadiazoles and their *N*-oxides (furazans and furoxans), mesoionic sydnone imines and azasydnones, pyridazine- and tetrazindi-*N*-oxides. The practically significant properties of the synthesized heterocyclic assemblies and the prospects for their use as nitric oxide donors or energy-rich materials will also be presented.

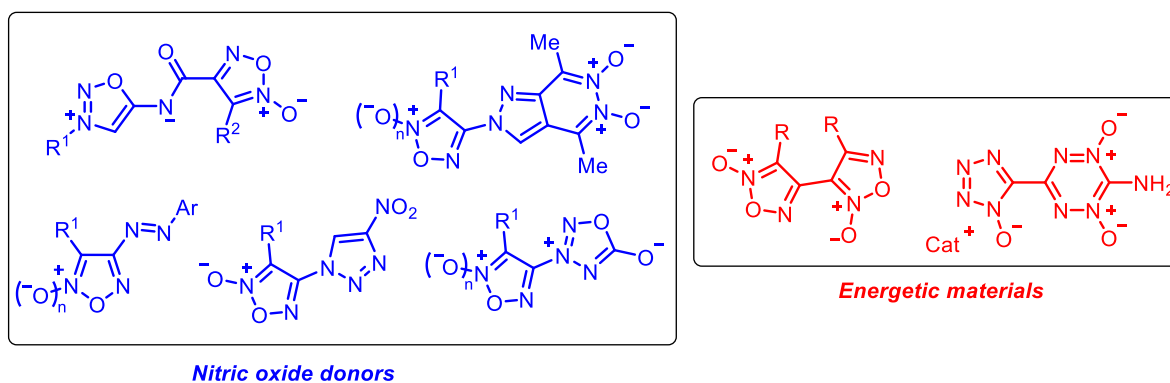

**Scheme 1.** Structures of the polynitrogen heterocycles presented in the report.

### References

- [1] *Chem. Eng. J.* **2024**, 486, 150410
- [2] *Russ. Chem. Rev.* **2024**, 93, RCR5109
- [3] *J. Org. Chem.* **2024**, 89, 174
- [4] *Molecules* **2023**, 28, 6969
- [5] *Green Chem.* **2023**, 25, 6686
- [6] *Chem. Eur. J.* **2023**, 29, e202300948
- [7] *Dalton Trans.* **2023**, 52, 7673
- [8] *Chem. Eng. J.* **2023**, 470, 144144
- [9] *Synthesis* **2023**, 55, 1863
- [10] *Dalton Trans.* **2022**, 51, 14088

### Acknowledgements

This work was supported by the Russian Science Foundation (project No 23-43-00090).



SYNTHESIS OF CHIRAL BORANES BY ASYMMETRIC INSERTION  
OF DIAZOACETATES INTO B-H BONDS

*Perekalin D.S.*<sup>1</sup>, *Ankudinov N.M.*,<sup>1</sup> *Komarova A.A.*<sup>1</sup>

<sup>1</sup> Nesmeyanov Institute of Organoelement Compounds, Moscow, Russia  
Head of the lab #133

[dsp@ineos.ac.ru](mailto:dsp@ineos.ac.ru)

Organic boranes are widely used as versatile reagents and building blocks in synthesis. However, many functional boranes cannot be prepared by traditional hydroboration, transmetalation, and borylation reactions. In this talk we will discuss the insertion of carbenes into B-H bonds, which provides unique chiral boranes.[1-2] Design of the chiral rhodium catalysts and the asymmetric poison approach will be also discussed.[3]

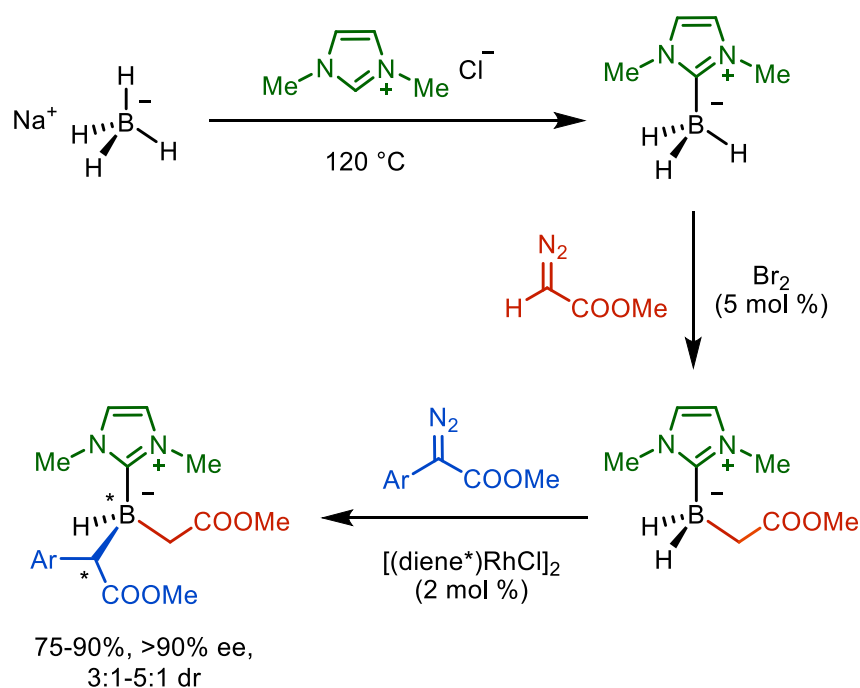

**Scheme 1.** Synthesis of chiral boranes.

### References

- [1] N. M. Ankudinov, D. A. Chusov, Y. V. Nelyubina, D. S. Perekalin, *Angew. Chem. Int. Ed.* **2021**, *60*, 18712.  
 [2] N. M. Ankudinov, A. A. Komarova, E. S. Podyacheva, D. A. Chusov, A. A. Danshina, D. S. Perekalin, *Chemrxiv* **2024**, doi: 10.26434/chemrxiv-2024-hnqvz  
 [3] E. A. Trifonova, N. M. Ankudinov, D. A. Chusov, Y. V. Nelyubina, D. S. Perekalin, *Chem. Commun.* **2022**, *58*, 6709.

### Acknowledgements

This work was supported by the Russian Science Foundation (project No 23-13-00345).

## NEW LIGANDS OF THE UBIQUITIN LIGASE CEREBLON FOR TARGETED PROTEASOMAL PROTEIN DEGRADATION

*Dar'in D.V.<sup>1</sup>, Kantin G.P.<sup>1</sup>, Bunev A.S.<sup>1,2</sup>, Kalinin S.A.<sup>1</sup>, Bakulina O.Yu.<sup>1</sup>*

<sup>1</sup> Saint Petersburg State University, Saint Petersburg, Russia

<sup>2</sup> Togliatti State University, Togliatti, Russia

[d.dar'in@spbu.ru](mailto:d.dar'in@spbu.ru)

Targeted proteasomal degradation is a young and promising field of pharmacology based on the ability of ubiquitin ligases to direct proteins for degradation by attaching a ubiquitin tag to them. The tool is a heterobifunctional chimeric molecule (PROTAC) consisting of a ligand of the protein of interest, a linker and a ligand for the ubiquitin ligase, most commonly cereblon. There are dozens of such molecules currently in clinical trials and, remarkably, the main optimisation in their design is focused on the linker and the ligand for the target protein. The standard ligand for cereblon is thalidomide or its closest analogues.

Our study focuses on optimising a fragment that binds to ubiquitin ligase (glutarimide moiety), which is particularly relevant in the context of the known toxic effects of thalidomide. The first effective tool we developed for the design of potential cereblon ligands is diazoreagent **1** acting through insertion reactions into the X-H bonds of various substrates, including NH-heterocycles (Scheme 1) [1]. In particular, we synthesized a benzotriazole analogue of thalidomide **2**.

Noteworthy, the bioisosteric replacement of the phthalimide fragment with a benzotriazole one had a positive effect on both the affinity for cereblon and the physicochemical and cytotoxic properties of the new ligand [2]. Based on the new cereblon ligands, chimeric PROTAC molecules were obtained that exhibited high activity with respect to target cancer cell cultures.

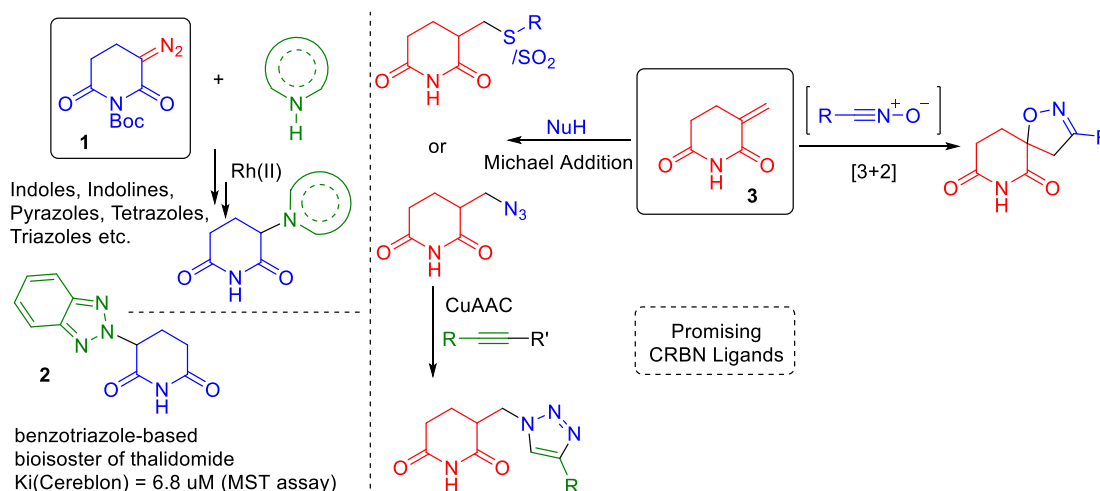

**Scheme 1.** Key precursors for developing a new chemical space of cereblon ligands.

Our second developed approach is based on reactivity of  $\alpha$ -methylidene-glutarimide **3**, specifically [3+2]-cycloaddition with nitrile oxides giving spirocyclic isoxazolines [3] and Michael addition with thiols [4] and azides. The latter was used to obtain a new substrate for the click reaction with acetylenes (CuAAC) affording triazoles.

### References

- [1] *J. Org. Chem.* **2023**, *19*, 1841-1848  
 [2] *J. Enzyme Inhib. Med. Chem.* **2022**, *37*, 527-530  
 [3] *Eur. J. Med. Chem.* **2024**, *270*, 116328  
 [4] *Eur. J. Med. Chem.* **2023**, *246*, 114990

### Acknowledgements

This work was supported by the Russian Science Foundation (project No 22-13-00005).

## FEP-BASED DESIGN OF CEREBLON LIGANDS IN BIFUNCTIONAL DEGRADER DEVELOPMENT

Buney A.S.<sup>1,2</sup>, Kudinov A.Yu.<sup>2</sup>, Kantin G.P.<sup>1</sup><sup>1</sup> St. Petersburg State University, St. Petersburg, Russia<sup>2</sup> Togliatti State University, Togliatti, Russia[brglab@ttsu.ru](mailto:brglab@ttsu.ru)

The presentation will cover advanced approaches to developing bifunctional molecules that are crucial for targeted protein degradation. It will highlight the complex challenges involved in optimizing E3-ligase ligands and linker attachment points, with the aim of preserving or enhancing binding within the ternary complex. Special emphasis will be placed on the role of physics-based modeling, including enhanced sampling and Free Energy Perturbation (FEP). In particular, the presentation will consider retrospective and prospective models for predicting the affinity of classical glutarimide derivatives and new cereblon binders [1-3].

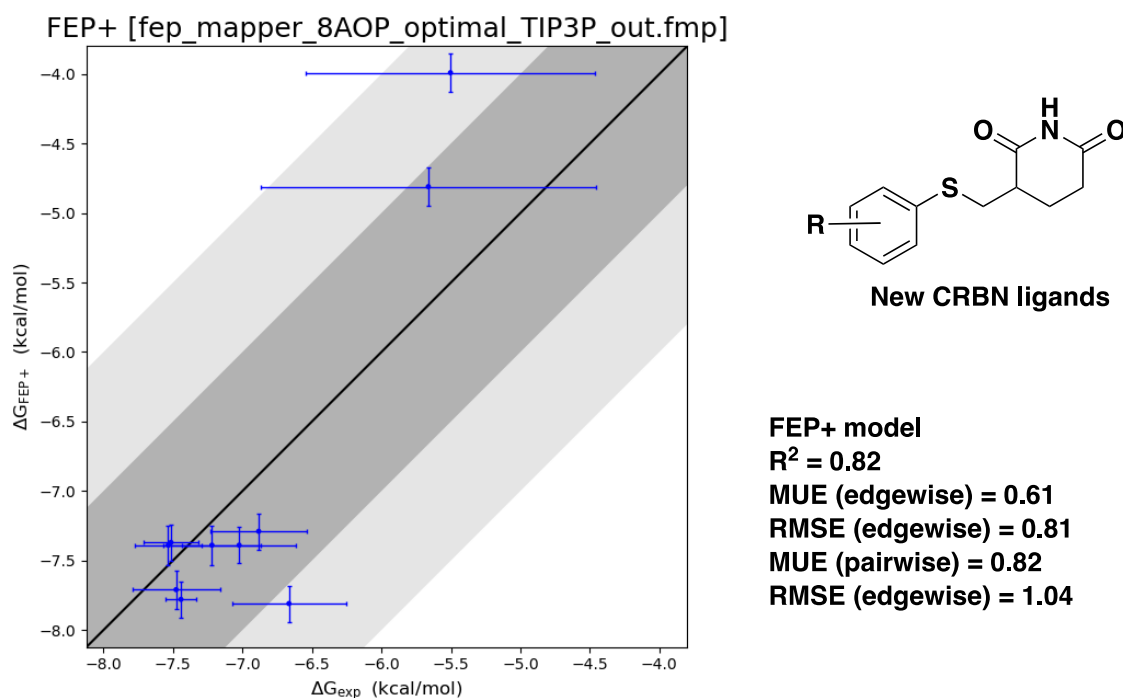

**Figure 1.** An example of a retrospective FEP+ model for new cereblon ligands

## References

- [1] *Eur. J. Med. Chem.* **2024**, 270, 116328  
 [2] *Eur. J. Med. Chem.* **2023**, 246, 114990  
 [3] *J. Enzyme Inhib. Med. Chem.* **2022**, 37, 527

## Acknowledgements

This work was supported by the Russian Science Foundation (project No 22-13-00005).



# **ORAL & POSTER PRESENTATIONS**

# SYNTHESIS OF Pt(IV) COMPLEXES OF ARYLBIPYRIDINES AS POTENTIAL ANTICANCER PRODRUGS

*Abramov V.M.*<sup>1</sup>, *Tokhtueva M.D.*<sup>1</sup>, *Melekhin V.V.*<sup>1</sup>, *El'tsov O.S.*<sup>1</sup>

<sup>1</sup> Ural Federal University, Institute of Chemical Engineering, Yekaterinburg, Russia

Graduate student

[vladislav.abramov@urfu.ru](mailto:vladislav.abramov@urfu.ru)

Cyclometallated Pt complexes are a unique class of organometallic compounds that are actively studied around the world due to their wide range of properties. Due to the properties of the central metal atom and ligand, they have a planar geometry, which determines their ability to  $\pi$ - $\pi$  and metal-metal interactions [1]. Due to these properties, the complexes are widely used in medicine, development of optoelectric devices and other functional materials. Their use in cancer chemotherapy is especially interesting [2]. One of the reasons reducing the effectiveness of Pt(II) antitumour drugs is side reactions of binding to proteins, as a result of which a significant part of the active substance is lost. One of the options to solve this problem is to change the geometry of the complex to octahedral by oxidation of the complexing agent, followed by reduction inside the cell.

The objective of this work was to prepare chlorinated Pt(IV) complexes of arylbipyridines based on the previously studied compounds showing antitumour properties [3]. The usage of  $\text{PhICl}_2$  as an oxidizing agent allowed us to obtain the product **2a-d**, which, however, was also substituted at the hydrogen atom of the aromatic ring. The use of stoichiometric ratios of reagents led to the formation of a mixture of products, which encouraged us to carry out a series of NMR experiments, in which it was found that the required ratio of the oxidizing agent to obtain substances **2a-d** is 3eq.

In order to obtain non-chlorinated on the aromatic ring analogues **3a-d**, the oxidation reaction of the starting substances **1a-d** in DMSO using concentrated hydrochloric acid was performed.

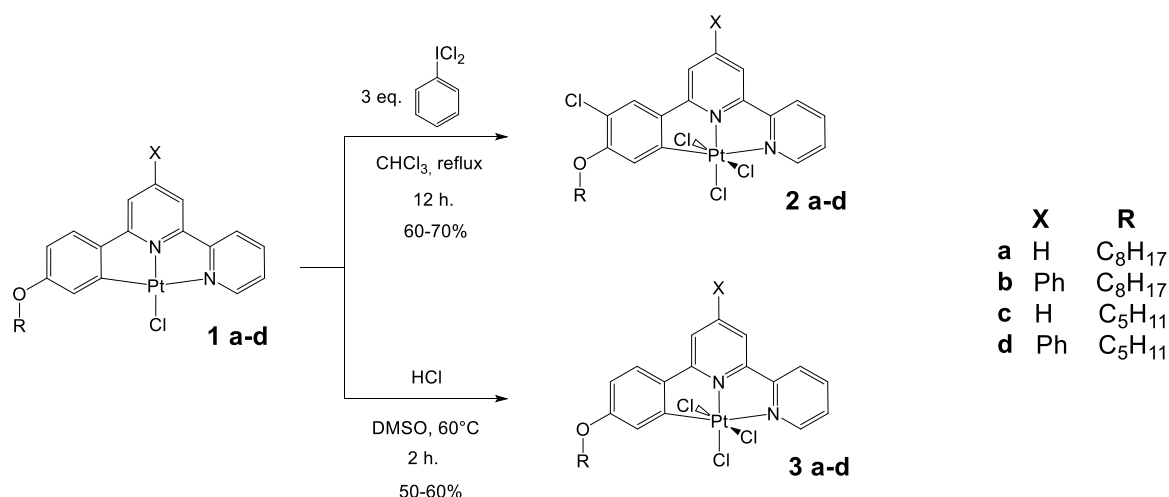

**Scheme 1.** Synthesis of Cl substituted Pt(IV) complexes with arylbipyridinc ligands.

The structure of the complexes was proved by  $^1\text{H}$ ,  $^{13}\text{C}$ ,  $^{195}\text{Pt}$ , 2D NMR and IR spectroscopy, and elemental analysis. The obtained complexes are promising objects for further biological studies.

## References

- [1] *J. Med. Chem.* **2007**, *50*, 3403–3411.
- [2] *SEER Cancer Statistics Review*, **2012**, National Cancer Institute: Bethesda, MD.
- [3] *Russ. Chem. Bull.* **2023**, *72*, 2848-2859

## Acknowledgements

This work was supported by the Russian Science Foundation (project No 23-23-00375).

# DISCOVERY OF 4,5-DIARYLPYRIDAZINES AS A NEW CLASS OF ANTI-TUBULIN AGENTS

Demchuk D.V.<sup>1</sup>, Adaeva O.I.<sup>1</sup>, Semenova M.N.<sup>2</sup>, Semenov V.V.<sup>1</sup>

<sup>1</sup> N.D. Zelinsky Institute of Organic Chemistry of Russian Academy of Sciences, Moscow, Russia

<sup>2</sup> N.K. Koltsov Institute of Developmental Biology of Russian Academy of Sciences, Moscow, Russia

PhD Student

[aoi.chem@mail.ru](mailto:aoi.chem@mail.ru)

Oncological diseases remain one of the main causes of mortality in the modern world, so the development of effective drugs capable of disrupting the division of pathological cells and inhibiting tumor growth is relevant. Compounds that are able to selectively target cell components and disrupt their division are of particular interest. These include drugs that act on microtubules - inhibitors of tubulin polymerization and depolymerization.

In our work, polyalkoxy-substituted 4,5-diarylpyridazines **1** were first obtained and their anti-proliferative properties were investigated.

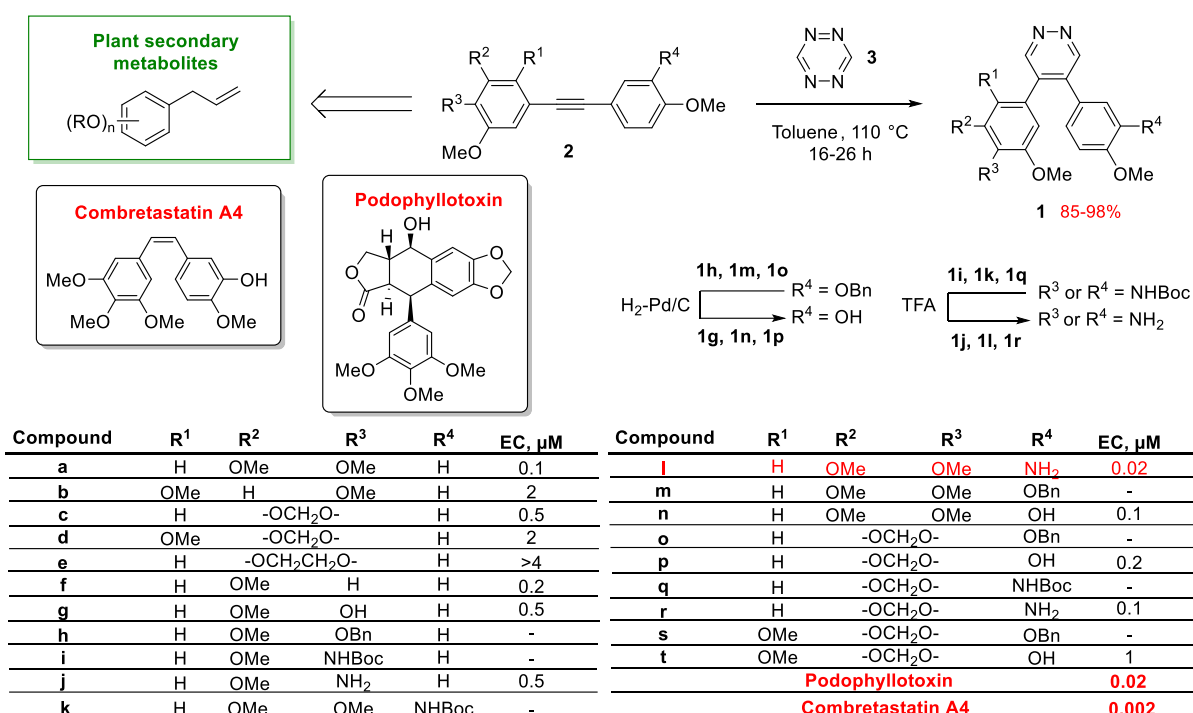

**Scheme 1.** Synthesis and biological activity of compounds **1**.

Most of the starting compounds were obtained from natural polyalkoxyallylbenzenes contained in the essential oil of parsley and dill, and the key reaction in the synthesis of the target molecules was [4+2] Diels-Alder cycloaddition (EDDA) between donor diarylacetylenes **2** and unsubstituted acceptor 1,2,4,5-tetrazine **3**. The biological activity of compounds **1** was evaluated compared to podophyllotoxin and combretastatin A4 using a sea urchin embryo model, which allows for the determination of substances that act on tubulin and destabilize microtubules. [1]. It was shown that all compounds have moderate anti-tubulin activity, with the most promising being aniline **1l**, which disrupts cell division at a concentration of 20 nM.

Thus, a series of polyalkoxy-substituted 4,5-diarylpyridazines was first obtained and studied, among which structures displaying anti-tubulin activity were found. It was shown that the most active ones contain hydroxy and amino groups at the R<sup>4</sup> position. Compound **1l** is of interest for further research into its cytostatic activity.

## References

[1] *BioTechniques* **2006**, *40*, 765

## Acknowledgements

This work was supported by the Russian Science Foundation (project No 24-23-00024).

# 3-DIAZOPIPERIDINE-2,4-DIONES IN THE SYNTHESIS OF SPIROCYCLIC BIS-LACTAMS VIA THE THERMALLY PROMOTED WOLFF REARRANGEMENT-STAUDINGER CYCLOADDITION

*Adamchik.M.A.*<sup>1</sup>, *Levashova E.Y.*<sup>1</sup>, *Dar'in D.V.*<sup>1</sup>

<sup>1</sup> St. Petersburg State University, St. Petersburg, Russia

Student

[st069126@student.spbu.ru](mailto:st069126@student.spbu.ru)

$\beta$ - And  $\gamma$ -lactams represent privileged azaheterocyclic motifs in medicinal chemistry and drug design, the introduction of which into a structure of a molecule can endow such compounds with a variety of biological activities, e.g. antibacterial, anticancer, etc, thus making them a key target for the development of effective synthetic approaches. One of the most well-established methods for the synthesis of  $\beta$ -lactams is the Staudinger [2+2] cycloaddition of ketenes and imines, with the former generated *in situ* via the Wolff rearrangement of  $\alpha$ -diazocarbonyl compounds [1]. We envisioned that introduction of 3-diazopiperidine-2,4-diones into the corresponding reaction would deliver spirocyclic compounds bearing both  $\beta$ - and  $\gamma$ -lactam moieties [2]. However, 3-diazopiperidine-2,4-diones were surprisingly insufficiently studied and scarcely exemplified, though representing promising precursors for the ketene formation.

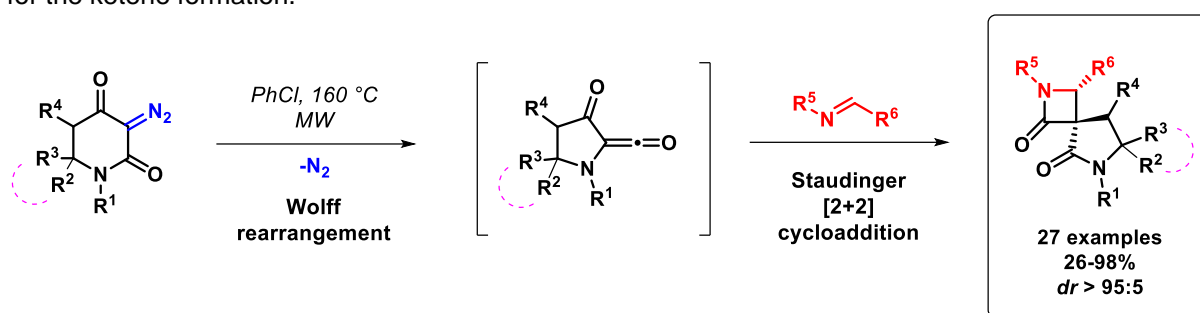

**Scheme 1.** Synthesis of spirocyclic bis-lactams from 3-diazopiperidine-2,4-diones with imines.

In this work, we have developed an efficient and straightforward approach for the synthesis of the aforementioned spirocyclic bis-lactams, based on the tandem of metal-free microwave-promoted Wolff rearrangement of the diazopiperidine-2,4-diones and the subsequent [2+2] Staudinger cycloaddition of thus obtained ketenes with imines, furnishing polysubstituted target compounds with a diverse periphery in good to high yields. The introduction of 6,6-disubstituted (spirocyclic) and 5,6-unsubstituted 3-diazopiperidine-2,4-diones into the reaction gave diastereomerically pure corresponding bis-lactams, whereas in the presence of a single substituent at the 6-position of the diazo reagent the formation of diastereomeric mixtures of products was observed. However, the relative configuration of three stereocenters in the target spirocyclic lactams can be controlled by employing 5-substituted 3-diazopiperidine-2,4-diones in the reaction. The investigation of the synthetic potential of 3-diazopiperidine-2,4-diones has been complemented by the study of their thermal decomposition in the presence of various nucleophiles to form derivatives of 2-oxopyrrolidine-3-carboxylic acids.

## References

- [1] *J. Org. Chem.* **2019** *84*(18), 12101-12110  
[2] *Molecules* **2022**, *27*, 2469

## Acknowledgements

This work was supported by the Russian Science Foundation (project No 20-13-00024).

THIAZOLO[3,2-*a*]PYRIMIDINE DERIVATIVES: NEW REARRANGEMENTS, CHIRAL SUPRAMOLECULAR ARCHITECTURES IN THE CRYSTALLINE PHASE AND ANTITUMOR ACTIVITY

*Agarkov A.S.*<sup>1,2</sup>, *Mingazhetdinova D.O.*<sup>2</sup>, *Nefedova A.A.*<sup>1</sup>, *Gabitova E.R.*<sup>2</sup>, *Kozhikhov A.A.*<sup>1</sup>,  
*Ovsyannikov A.S.*<sup>1,2</sup>, *Litvinov I.A.*<sup>1</sup>, *Voloshina A.D.*<sup>1</sup>, *Solovieva S.E.*<sup>1</sup>, *Antipin I.S.*<sup>2</sup>

<sup>1</sup> Arbuzov Institute of Organic and Physical Chemistry, FRC Kazan Scientific Center, Russian Academy of Sciences, Kazan, Russia

<sup>2</sup> Kazan Federal University, Kazan, Russia

PhD of chemistry

[artem.agarkov.95.chem@mail.ru](mailto:artem.agarkov.95.chem@mail.ru)

In recent years, there has been an increasing interest in modern supramolecular and organic chemistry in the search for technologically simple and cost-effective approaches to the separation of chiral compounds with potential biological activity. The aim of this work is to develop and optimize methods for the synthesis of racemic 2-substituted thiazolo[3,2-*a*]pyrimidine derivatives, as well as previously unavailable heterocyclic derivatives based on them (triazolo[4,3-*a*]pyrimidines, 3,5-diaryl-2,3-dihydrothiazolo[3,2-*a*]pyrimidines, imidazo[2,1-*b*]thiazoles), and cytotoxic activity. In this paper, attention is focused on creating a hierarchical approach for tuning supramolecular syntones in order to implement chiral discrimination in the crystalline phase [1-8].

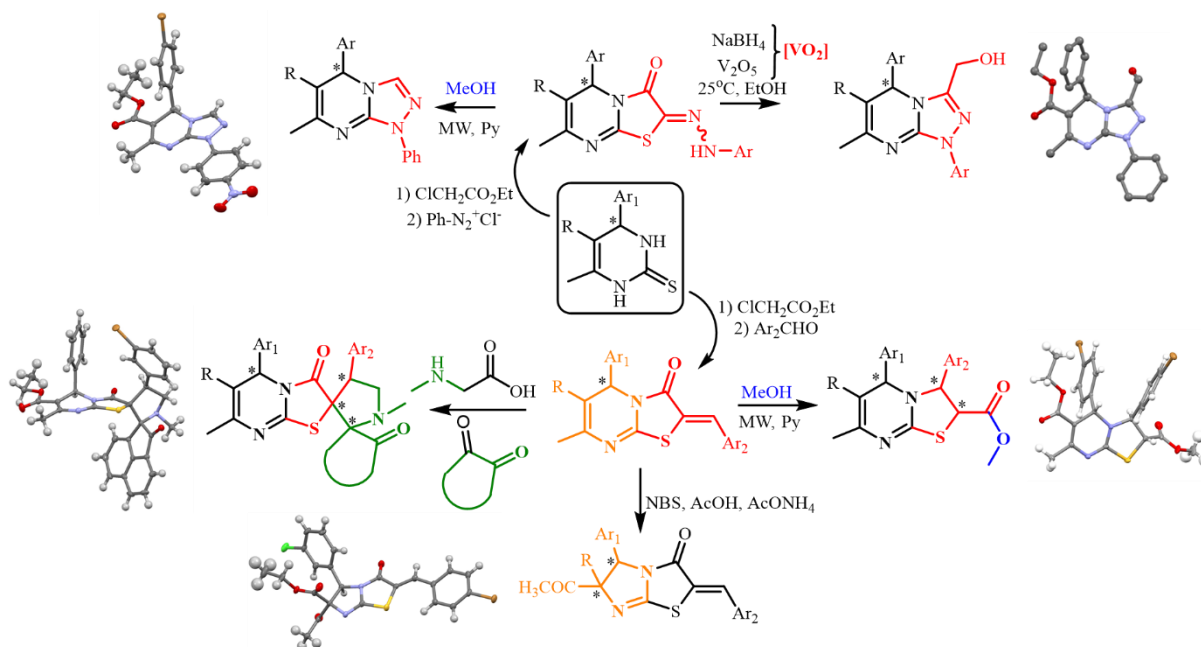

**Scheme 1.** Key reaction routes considered in the report.

### References

- [1] *Russ. J. Org. Chem.* **2023**, 59(3), 337-364
- [2] *Chem. Heterocycl. Compd.* **2019** 55(12),1217-1221
- [3] *Dokl. Chem.* **2022**, 503(1), 45–50
- [4] *Crystals* **2022**, 12(4), 494
- [5] *Molecules* **2022**, 27(22), 7747
- [6] *Int. J. Mol. Sci.* **2023**, 24(3), 2084
- [7] *Dokl. Chem.* **2022**, 505(2), 177-183
- [8] *Organics* **2023**, 4(3), 438-446

### Acknowledgements

The authors are grateful to the Assigned Spectral-Analytical Center of Shared Facilities for Study of Structure, Composition and Properties of Substances and Materials of the Federal Research Center of Kazan Scientific Center of Russian Academy of Sciences (CSF-SAC FRC KSC RAS) for technical support



# NEW CHROMONE-BASED DERIVATIVES OF 10-MEMBERED LACTONES OBTAINED BY TANDEM NUCLEOPHILIC ADDITION-INTRAMOLECULAR CONDENSATION REACTION

Alekseeva A.N.<sup>1</sup>, Fedorov A.N.<sup>1</sup>

<sup>1</sup> All-Russian institute of plant protection, St. Petersburg, Pushkin, Russia

Young scientists

[yuyi99@mail.ru](mailto:yuyi99@mail.ru)

Fungal 10-membered lactones (TMLs) represent an interesting and structurally diverse group of secondary metabolites with potent biological activity. Several TMLs are known as promising candidates for the development of nature derived herbicides [1]. Nevertheless, the rational optimization of their structures for use as plant protection products is complicated by poorly explored chemical properties of the functionalized lactone core.

Previously we found that TMLs with an  $\alpha,\beta$ -unsaturated keto group are prone to spontaneous rearrangement into hexahydro-4H-chromones. In particular, stagonolide A (**1**) rearranges to stagochromene A in a protic medium, and one of the by-products of pinolidoxone **2** hydrogenation is a saturated chromone with a hemiketal group. In this work, we demonstrate examples of tandem nucleophilic addition and rearrangement of 10-membered lactones. Thus, using this reaction based on natural phytotoxins, it is possible to obtain previously unknown fused bi- and tricyclic heterocycles with potential applications for plant protection.

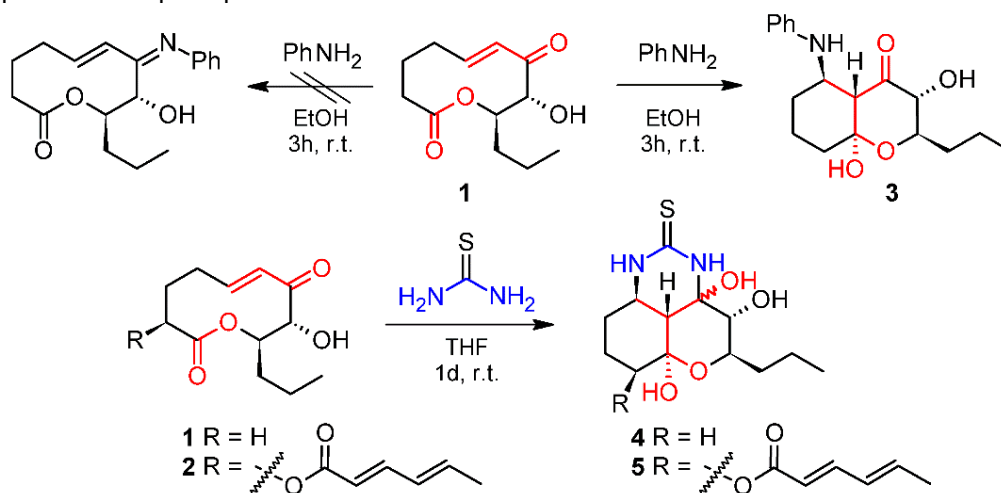

**Scheme 1.** Addition of amines to stagonolide A (**1**) and pinolidoxone **2**.

The addition of aniline to stagonolide A (**1**) does not afford the corresponding imine and instead occurs via 1,4-addition followed by simultaneous C1-C6 intramolecular Claisen condensation. As a result the hexahydro-4H-chromone **3** was formed with the isolated yield of 85%. The reaction of lactones **1** and **2** with thiourea proceeds in a similar manner, but also involves the neighboring carbonyl group, forming tricyclic pyrimidinethiones **4** and **5** with isolated yields of 67 and 54%, respectively.

The reported reactions can be classified as click-addition due to mild conditions, absence of a catalyst, stereospecificity. Stereocontrol of the reaction is determined by the conformation of the starting lactones as the intramolecular attack is possible exclusively from above of the ester group plane. The structures and composition of products **2**, **4-5** were confirmed by spectral methods (1D/2D NMR and ESI-MS). Similar chromone with a hemiketal moiety called bellidisin A was recently isolated from *Phoma billidis* [2]. The above-described tendency of stagonolide A and its structural analogs to intramolecular rearrangement can be considered as a new mild method for obtaining fused aliphatic heterocycles from TMLs.

## References

[1] *Nat. Prod. Rep.* **2024**, *41*, 85-112

[2] *Phytochem. Lett.* **2019**, *29*, 41-46

## Acknowledgements

The research was funded by Russian Science Foundation No. 22-16-00038.

# AZIDE-ALKYNE CYCLOADDITION OF ARYL PROPARGYL ETHERS: KINETICS AND SYNTHETIC FEATURES OF THE PROCESS IN NON-ISOTHERMAL CONDITIONS

*Aleshin R.P.<sup>1</sup>, Galukhin A.V.<sup>1</sup>*

<sup>1</sup> Kazan (Volga) Federal University, Alexander Butlerov Institute of Chemistry, Kazan, Russia

PhD student

[msizhir-kniga@mail.ru](mailto:msizhir-kniga@mail.ru)

Azide-alkyne cycloaddition (AAC) reactions are broadly applied in medical chemistry for the introduction of biocompatible fluorescent and mass-spectrometric markers [1]. 1,2,3-triazole-based materials demonstrate excellent fire-retardant, anticorrosion and bactericide functions. Practice of AAC-functionalized polymers includes adhesives, self-healing materials, composites, polyionic materials, and polytriazolium vitrimers [2-3].

To scale-up the production of triazole-based materials, it is essential to determine the optimal parameters of thermally induced AAC processes. High exothermic effect of AAC causes a potential problem of thermal runaway when thermal accumulation leads to fast temperature rise and progress of unwanted side reactions. AAC usually proceeds as a 2<sup>nd</sup>-order reaction so isothermal conditions may cause the decrease of the process yield at low and intermediate temperatures. These clues indicate the non-isothermal regimes of AAC should be applied. A constant heat rate regime allows one to execute the triazoles production at adequate rates since the decrease of reagent concentration is compensated by the temperature evolution. Solvent-free systems not only follow the green chemistry principles but also lead to higher reaction rates; however, such conditions require a strict control of temperature regime and heat flow of the desired reaction.

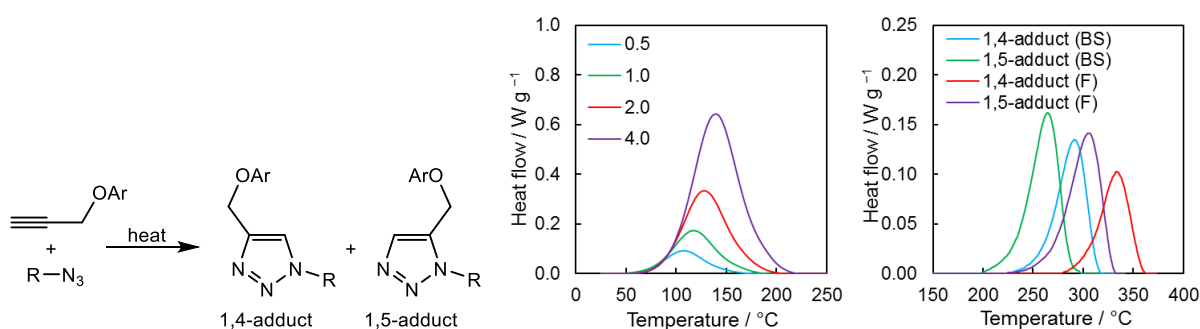

**Scheme 1.** AAC of aryl propargyl ethers leading to the regioisomeric products.

**Figure 1.** (A) DSC-curves of a single AAC set. Curve names show the applied heat rate. (B) DSC-curves of decomposition of isomeric triazoles at heat rate of 4 K min<sup>-1</sup>. BS stands for 'bulky substitution'; F means 'free'.

In this research, we have analyzed the influence of heating conditions and substituents in aryl propargyl ethers on the course of AAC reactions. For this purpose, the AAC of several synthesized alkyl-substituted aryl propargyl ethers and 1-azidotetradecane has been investigated in non-isothermal variant. Detailed study of AAC kinetics has relied on the data obtained via differential scanning calorimetry (DSC; Figure 1A), UV-HPLC and NMR spectral analysis methods. Most of the studied reactions have proceeded uniformly as shown by kinetics. Instead, AAC of the most hindered aryl propargyl ether has specified atypical side processes at temperatures exceeding 200 °C. Further explorations have demonstrated (Figure 1B) a sufficient difference in thermal stability of regioisomers which has led to the enhanced decomposition of 1,5-adducts at high temperatures and decrease of their content in the product mixtures. This effect has been the most pronounced for the triazoles formed from sterically hindered aryl propargyl ethers. As a result, we have formulated the triazole syntheses should be conducted at low heat rates and temperatures below 180 °C.

## References

- [1] *Drug Discov. Today* **2003**, 8, 1128
- [2] *J. Controlled Release* **2018**, 273, 160
- [3] *Des. Monomers Polym.* **2020**, 23, 50

## Acknowledgements

This work was supported by the Russian Science Foundation (project No 22-73-10122).

# SYNTHESIS OF NEW CYCLIC SYSTEMS *PERI*-ANNULATED TO THE INDOLE RING

*Antropov S.M.*<sup>1</sup>, *Tokmacheva S.A.*<sup>1</sup>, *Trushkov I.V.*<sup>1</sup>

<sup>1</sup> N.D. Zelinsky Institute of Organic Chemistry, Moscow, Russia

PhD student

[smantropov@gmail.com](mailto:smantropov@gmail.com)

The synthesis of compounds in which some cyclic system is *peri*-fused to the indole core remains an important challenge for the modern organic chemistry. Among the enormous range of natural and synthetic bioactive indoles, such compounds occupy a special place due to their importance for medicinal chemistry and pharmacology. In this work, we present a new approach to the synthesis of various types of polycyclic *peri*-annulated indoles starting from (3-formylindol-4-yl)-substituted donor-acceptor cyclopropanes. Under the treatment with primary amines in the presence of ytterbium(III) triflate, they produce bridged tetracyclic scaffold containing *peri*-fused indole and tropane fragments *via* domino reaction; at the first step the corresponding imine is formed, which then is involved in (3+2)-cross-cycloaddition with cyclopropane fragment [1].

Another type of domino reaction occurred when these cyclopropanes react with hydrazines. The first step is similar, *i.e.*, the formation of the corresponding hydrazones. Unlike imines, they contain a nucleophilic NH group, its nucleophilic attack on cyclopropane leads to the opening of a small ring affording a tricyclic system, containing a diazepine moiety *peri*-annulated to the indole ring. Reduction of the C=N bond followed by cyclization produced another bridged tetracyclic system containing a *peri*-annulated indole core.

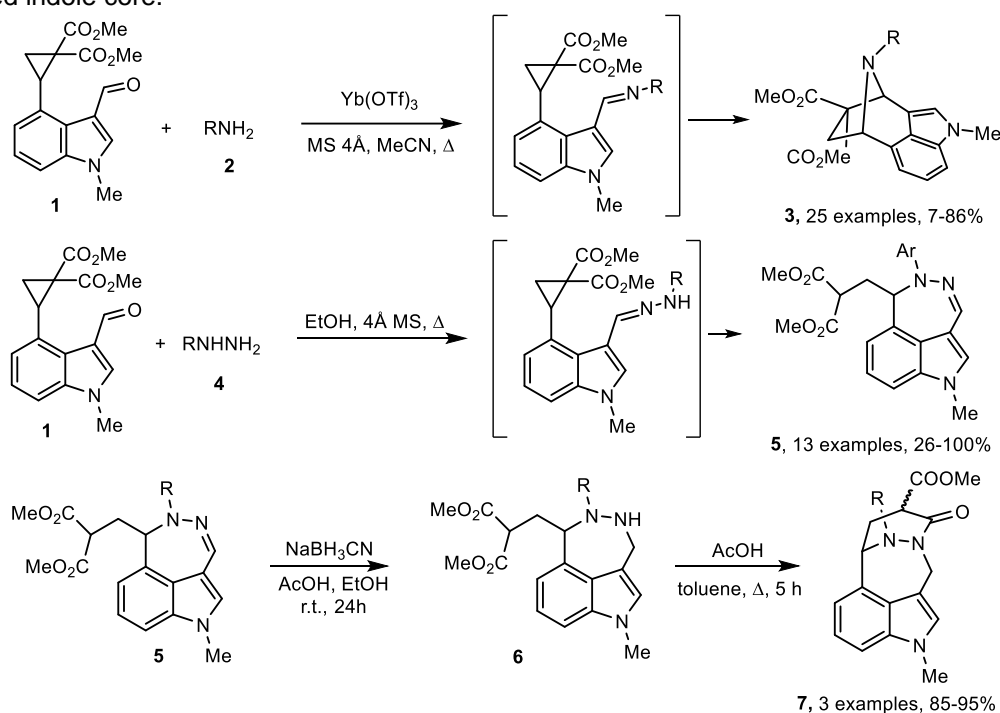

**Scheme 1.** Pathways of new types of *peri*-annulated indoles synthesis.

## References

[1] *Adv. Synth. Catal.* **2024**, doi: 10.1002/adsc.202400279.

## Acknowledgements

This work was supported by the Russian Science Foundation (project 2024-13-00255).

TRANSFORMATIONS OF TMS ESTERS OF  $\beta$ -ARYL- $\alpha$ -THIOPHENYL-TRIFLUOROPROPANOLS UNDER THE ACTION OF ACIDS

Arkaniya L.Z.<sup>1</sup>, Khoroshilova O.V.<sup>1</sup>, Vasilyev A.V.<sup>1,2</sup>

<sup>1</sup> St. Petersburg State University, St. Petersburg, Russia

<sup>2</sup> St. Petersburg State Forest Technical University, St. Petersburg, Russia

Student

[st091186@student.spbu.ru](mailto:st091186@student.spbu.ru)

The central place in the synthesis of new biologically active substances is occupied by small organic molecules that easily penetrate cell membranes [1]. Thus, five-membered aromatic heterocycles are building blocks for synthesis of many drugs [2]. The introduction of a fluorine atom into molecules significantly affects their physical, biochemical and pharmacological properties [3]. For this reason, the synthesis of new fluoroorganic compounds containing thiophene seems to be current task in organic chemistry.

We found that TMS esters **2a-c** have two reactive centers on carbon atoms C1, C2. Thus, interacting TMS esters **2** with arenes in the presence of superacid CF<sub>3</sub>SO<sub>3</sub>H (TfOH) undergo various transformations (pathways **a-e**) depending on the used nucleophile and the structure of the original compound. In most cases, side chain arylation products **3**, **4** are formed, but in the case of the reaction of monosubstituted thiophene ring arylation product **6c** is formed. Reactions of TMS ester **2a** with weak nucleophiles can form both alkene **5a** and a product of ionic hydrogenation **7a**. Alkene **5a** can be used for the synthesis of compounds **4**.

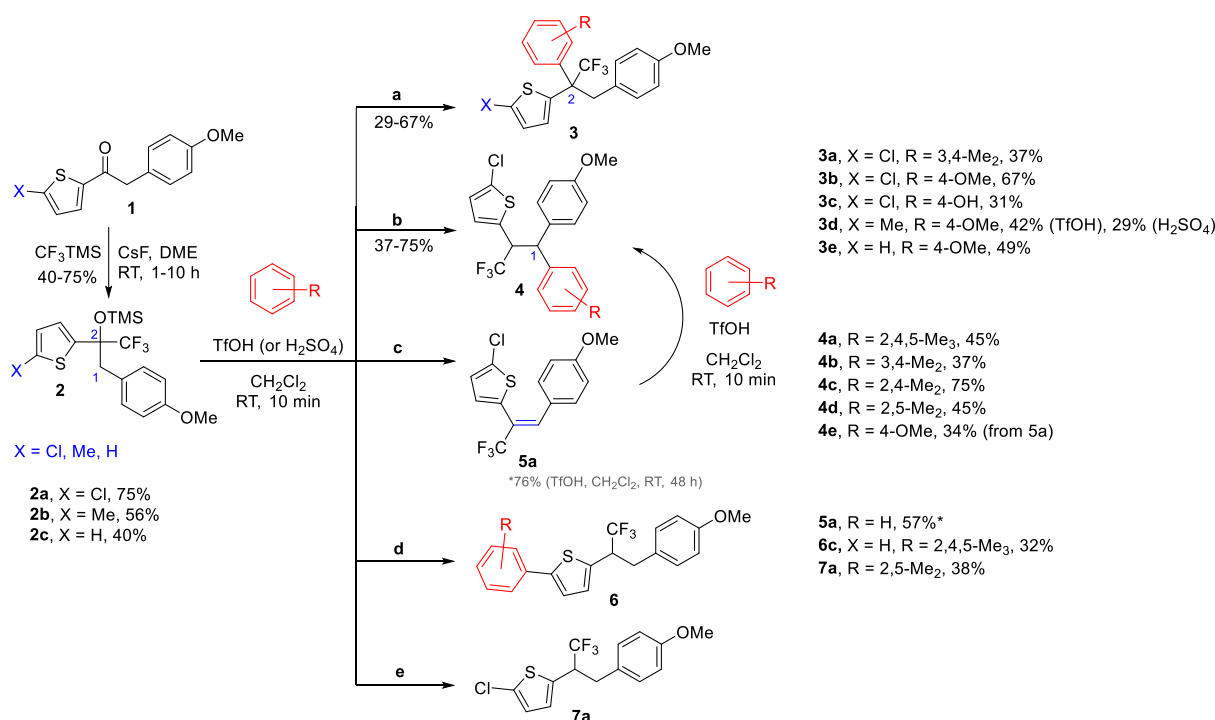

**Scheme 1.** Transformations of TMS esters  $\beta$ -aryl- $\alpha$ -thiophenyl-trifluoropropanols with arenes under the action of acids.

### References

- [1] *ACS Omega* **2020**, 5(19), 10633–10640  
 [2] *Chem. Res. Toxicol.* **2014**, 27(8), 1344–1358  
 [3] *Chem. Rev.* **2014**, 114(4), 2432–2506

# CHITOSAN COATED GOLD NANORODS AS PRECURSORS OF AGENTS FOR HYPERTHERMAL AND PHOTODYNAMIC THERAPY

Aslanov S.F.<sup>1</sup>, Svinko V.O.<sup>1</sup>, Solovyeva E.V.<sup>1</sup>

<sup>1</sup> St. Petersburg State University, St. Petersburg, Russia  
Student

[aslanov.simar@gmail.com](mailto:aslanov.simar@gmail.com)

Gold nanoparticles have been actively studied over the past two decades as components of new optical materials. Wide possibilities for surface modification, optical signal amplification, and conversion of light energy into thermal energy make them promising candidates at tools of chemical and biological analysis, diagnostics, and therapy. In particular, the potential of gold nanoparticles (NPs) for hyperthermal therapy, photodynamic therapy and optical tomography is currently recognized by scientific community [1-2].

The purpose of this work was to develop a biocompatible hybrids based on anisotropic gold NPs coated with chitosan as a component of a gel for photothermal therapy of superficial tumors. The objective of the study was to test various approaches to the synthesis and testing of hybrids for toxicity. Gold NPs of various shapes (nanorods, nanospheres and nanostars) were obtained on a preliminary step. The synthesis was carried out according to known methods [3-4], but with certain modifications. The resulting NPs were coated with high molecular weight chitosan using eight different techniques.

The quality of surface coating was checked using analytical methods such as transmission electron microscopy (TEM) and zeta potential measurements. To analyze the nanoparticle size, dynamic light scattering and scanning electron microscopy were used. To verify the toxicity of the resulting hybrids on human blood, the following tests were performed: photo-induced and spontaneous hemolysis, platelet aggregation and test on mitochondrial activity.

Resulting hybrids showed pronounced pro-oxidant properties. Even in low concentrations they significantly accelerate a speed of photohemolysis induced by photosensitizer – chlorine e6 (Fig. 1).

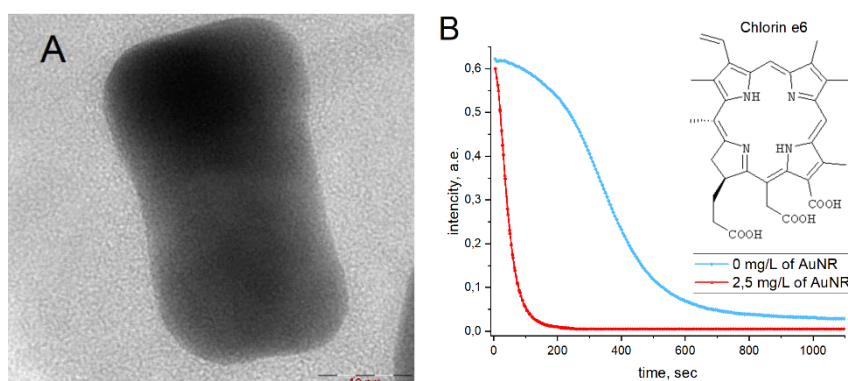

**Figure 1.** (A) – TEM image of gold nanorods used, (B) –Photohemolysis curves of red blood cells induced with chlorine e6 without (blue line) and with (red line) gold NPs (2.5 mg/L). The structure of chlorine e6 is shown on the right part.

The results of the work are:

- well working synthetic technique of coating the gold nanoparticles in one-reactor mode;
- the methodology for using gold nanoparticles coated with chitosan in photothermal therapy.

## References

- [1] *Int. J. Pharm.* **2019**, 565, 174
- [2] *Materials* **2010**, 3, 1420
- [3] *Nano. Lett.* **2007**, 7, 1297–1303
- [4] *J. Phys. Chem. B.* **1999**, 103, 4212–4217

## Acknowledgements

This work was supported by the Russian Science Foundation (project № 22-73-10052).

# NOVEL PYRIDO[1,2-A]BENZIMIDAZOLE-FUSED PORPHYRAZINE COMPLEXES: SYNTHESIS, PHOTOCHEMICAL PROPERTIES AND PHOTODYNAMIC ACTIVITY

*Belousov M.S.<sup>1</sup>, Dubinina T.V.<sup>1</sup>*

<sup>1</sup> Moscow State University, Moscow, Russia

PhD student, Master of science

[mikbelousov99@gmail.com](mailto:mikbelousov99@gmail.com)

Pyrido[1,2-a]benzimidazole-fused porphyrazines represent a new class of phthalocyanine analogues. They consist of a porphyrazine core with four fused pyrido[1,2-a]benzimidazole moieties. Such compounds are considered promising photosensitizers for photodynamic therapy of cancer (PDT) due to the strong shift of the absorption maximum to the near-IR region.

Firstly, pyrido[1,2-a]benzimidazole-annulated zinc porphyrazine **4** was obtained by a three-step approach starting from 4-bromo-5-nitrophthalonitrile **1**. The possibility of quaternization for this complex was demonstrated by reactions with dimethyl sulfate and benzyl chloride. As a result, water-soluble photosensitizers **5** and **6** were obtained.

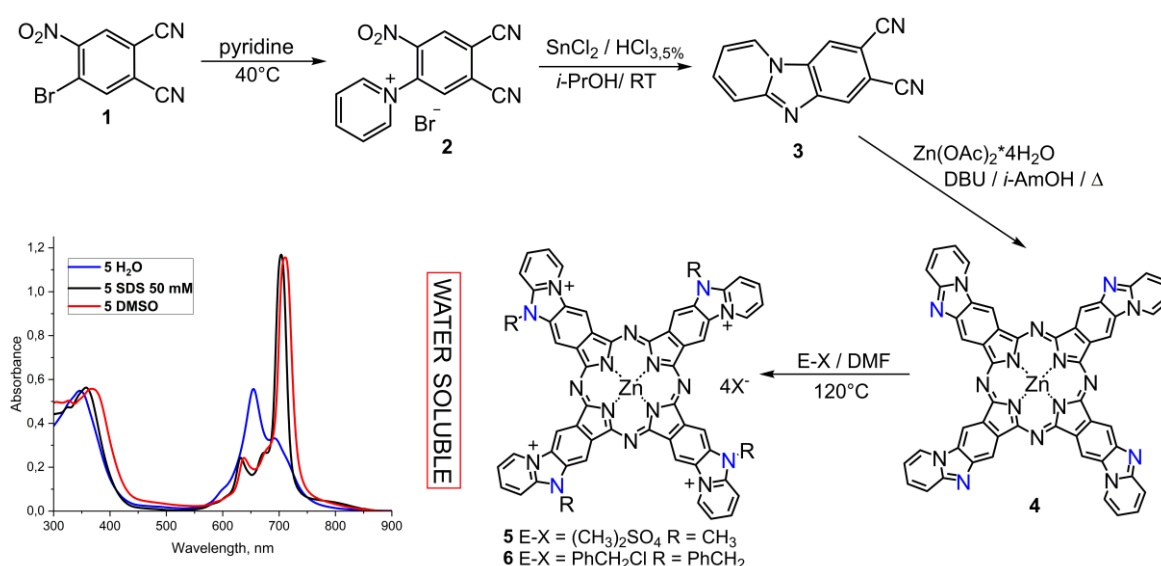

**Scheme 1.** Synthesis and UV-Vis spectra of quaternized complexes **5** and **6**.

Then the aggregation behavior of quaternized complexes **5** and **6** in an aqueous medium was studied and triplet absorption spectra in water were measured. In addition, the quantum yields of singlet oxygen generation and fluorescence were determined in DMSO.

Target pyrido[1,2-a]benzimidazole-fused porphyrazines **4-6** were characterized by MALDI TOF mass spectrometry, Fourier transform IR, and <sup>1</sup>H NMR spectroscopy. In the UV/Vis spectra, a bathochromic shift of the absorption maximum to the near-IR region up to 746 nm was observed, which is in the range of high transparency of biological tissues.

To determine the photodynamic activity of quaternized complexes **5** and **6**, light and dark cytotoxicity were measured on the HeLa, HCT116, MCF7, WI38, A549 and A431 cell lines. Low dark cytotoxicity was found for both complexes, whereas light cytotoxicity values were found to be as high as 180 nM. The obtained characteristics were better than those of chlorin e6, the active component of widely used PDT drugs.

## Acknowledgements

This work was supported by the Russian Science Foundation (project No 23-73-10076).

# NUCLEOPHILIC RING-OPENING REACTIONS IN THE SYNTHESIS OF HETEROCYCLES FROM DONOR-ACCEPTOR CYCLOPROPANES

Boichenko M.A.<sup>1</sup>, Trushkov I.V.<sup>2</sup>, Ivanova O.A.<sup>1</sup>

<sup>1</sup> Moscow State University, Moscow, Russia

<sup>2</sup> N.D. Zelinsky Institute of Organic Chemistry, Moscow, Russia

Ph.D. Student

[dioptase.96@gmail.com](mailto:dioptase.96@gmail.com)

The presence of an activated strained three-membered ring, in which the donor and acceptor fragments are located at the vicinal carbon atoms, makes DAC very attractive substrates in fine organic synthesis. In recent decades, numerous studies have been carried out on the reactivity of DA cyclopropanes towards various nitrogen-containing nucleophilic reagents, and the possibility of using these methods in the synthesis of aza-heterocyclic compounds has been explored [1-5]. The reaction of nucleophilic ring-opening of DAC allows for one-step synthesizing acyclic molecules containing several nucleophilic and electrophilic centers, the subsequent pairwise interaction of which, with activation under certain conditions, makes it possible to obtain diverse cyclic compounds, including polycyclic ones with a complex ring topology. Here, we present new approaches to the preparation of various cyclic derivatives of  $\gamma$ -aminobutyric acid (GABA), which are privileged structures in medicinal chemistry, based on the nucleophilic ring-opening of DA cyclopropanes with anilines, benzylamines and azide ion. Methods for the synthesis of polysubstituted pyrrolidin-2-ones, tetrahydrodibenzo[*c,e*]pyrrolo[1,2-*a*]azepin-7-ones (structural analogues of the alkaloid allocolchicine), and tetrahydropyrrolo[1,2-*a*]quinolinones have been developed. Also, we disclosed an approach to the preparation of  $\gamma$ -cyanoesters, where trimethylsilyl cyanide was used as a cyanide ion surrogate. These compounds can be used as intermediates in the synthesis of a number of bioactive molecules, e.g. derivatives of  $\delta$ -aminovaleric acid, 3-arylpiperidines and a lot of substituted  $\beta$ -phenylethylamines.

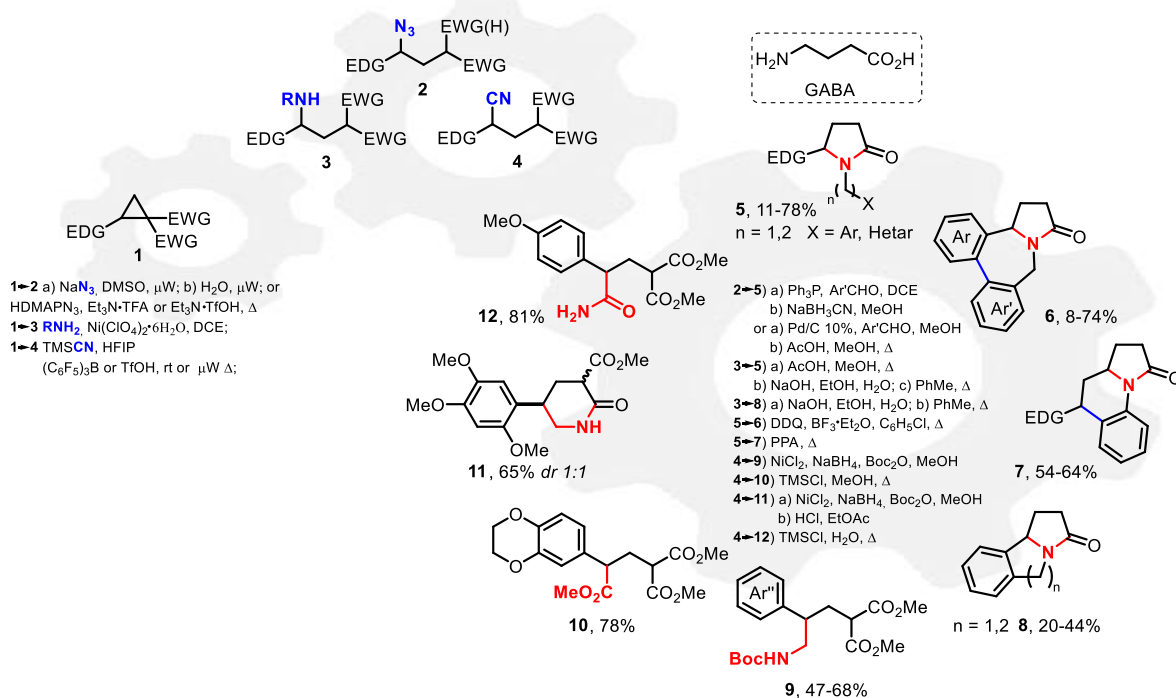

**Scheme 1.** Ring-opening of donor-acceptor cyclopropanes in the synthesis of heterocycles.

## References

- [1] *Org. Chem. Front.* **2018**, *5*, 2829
- [2] *J. Org. Chem.* **2020**, *85*, 1146
- [3] *Molecules* **2022**, *27*, 8468
- [4] *Synth. Catal.* **2022**, *364*, 2403
- [5] *Chem. Heterocycl. Compd.* **2023**, *59*, 54

## Acknowledgements

This work was supported by the Russian Science Foundation (project No 21-73-20095).

## 2,3-DIARYLMALEATE SALTS AS A VERSATILE CLASS OF DIARYLETHENES WITH A FULL SPECTRUM OF PHOTOACTIVITY IN WATER

*Bolotova I.A.*<sup>1,2</sup>, *Ustyuzhanin, A. O.*<sup>1,2</sup>, *Sergeeva E. S.*<sup>1,2</sup>, *Faizdrakhmanova A. A.*<sup>1,2</sup>, *Hai Y.*<sup>3</sup>,  
*Stepanov A. V.*<sup>1,2</sup>, *Ushakov I. A.*<sup>2</sup>, *Lyssenko K. A.*<sup>4</sup>, *You L.*<sup>3</sup>, *Lvov A. G.*<sup>1,2</sup>

<sup>1</sup> Irkutsk National Research Technical University, Irkutsk, Russia

<sup>2</sup> A.E. Favorsky Irkutsk Institute of Chemistry SB RAS, Irkutsk, Russia

<sup>3</sup> Fujian Institute of Research on the Structure of Matter, Fuzhou, China

<sup>4</sup> Department of Chemistry, Moscow State University, Moscow, Russia

PhD

[bolotovachem@gmail.com](mailto:bolotovachem@gmail.com)

Transferring conventional chemical processes from organic solvents to water is a crucial step in the development of bioinspired and environmentally friendly chemical technologies [1]. Diarylethenes have a diverse photochemistry that involves both irreversible and reversible reactions, which are sought after for organic synthesis, materials chemistry, and photopharmacology [2,3]. A common method for the preparation of water-soluble DAEs is the introduction of positively or negatively charged functional groups into the structure of the molecule [1].

This work presents the first versatile class of diarylethenes, namely potassium 2,3-diarylmaleates **2** (DAMs), which exhibit excellent solubility in water. DAMs **2** that originate from accessible substrates **1**, undergo either irreversible reactions (oxidative cyclization or rearrangement) or reversible photocyclization (switching) as per the aromatic substituents. The versatility and availability of the obtained class pave the way for wider application of diarylethenes in photopharmacology and biotechnology requiring aqueous media for photochemical reactions [4].

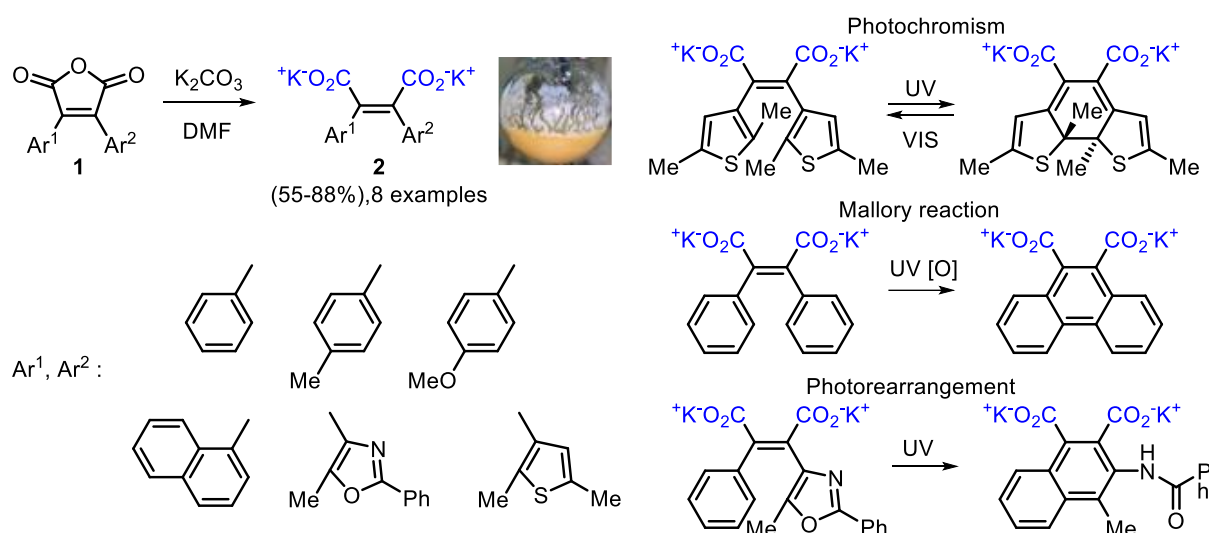

**Scheme 1.** Synthesis of the DAM salts and their photochemical reactions in water.

### References

- [1] *Chem. Soc. Rev.*, **2021**, 50, 12377
- [2] *Russ. Chem. Rev.*, **2012**, 81, 477
- [3] *Chem. Rev.*, **2014**, 114, 24, 12174
- [4] *Chem. Sci.*, **2023**, 14, 9553

### Acknowledgements

This work was supported by the Ministry of Science and Higher Education of the Russian Federation within the framework of the Baikal World-class Scientific and Educational Center (FZZS-2024-0001).



# ACTIVATION OF ANTHRAQUINONE'S ELECTROPHILICITY BY LIGHT FOR A DYNAMIC C–O BOND

Bykov V.N.<sup>1,2</sup>, Ukhanev S.A.<sup>2</sup>, Ushakov I.A.<sup>2</sup>, Vologzhanina A.V.<sup>3</sup>, Antsiferov E.A.<sup>1</sup>, Klimenko L.S.<sup>4</sup>, Lvov A.G.<sup>1,2</sup>

<sup>1</sup> Irkutsk National Research Technical University, Irkutsk, Russia

<sup>2</sup> A.E. Favorsky Irkutsk Institute of Chemistry SB RAS, Irkutsk, Russia

<sup>3</sup> A.N. Nesmeyanov Institute of Organoelement Compounds, Moscow, Russia

<sup>4</sup> Ugra State University, Khanty-Mansiysk, Russia

Postgraduate

[irkbwn.chem@yandex.ru](mailto:irkbwn.chem@yandex.ru)

*Peri*-aryloxyquinones (PAQs) are a unique class of photoswitchable compounds that were discovered in the USSR in 1971. Isomerization of PAQs under the light occurs as a result of reversible transfer of the aryl group to form a metastable *ana*-quinone characterized by a high reactivity towards nucleophiles. [1]

In our work, we used light-mediated activation of PAQ electrophilicity to realize dynamic C–O covalent bond for the first time. We found that the photogenerated *ana*-isomers of PAQs react with phenols via the *oxa*-Michael reaction to form previously unknown 4-hydroxy-10,10-diaryloxanthracene-9-ones. The latter are in equilibrium with the corresponding *ana*-quinones, forming a dynamic covalent system of a new type. Removal of colored *ana*-quinones from the equilibrium system by visible light irradiation leads to the formation of two *para*-quinones with fixed aryloxy groups. [2] This phenomenon could be used for controllable conjugation of light-switchable PAQs with phenol-containing materials.

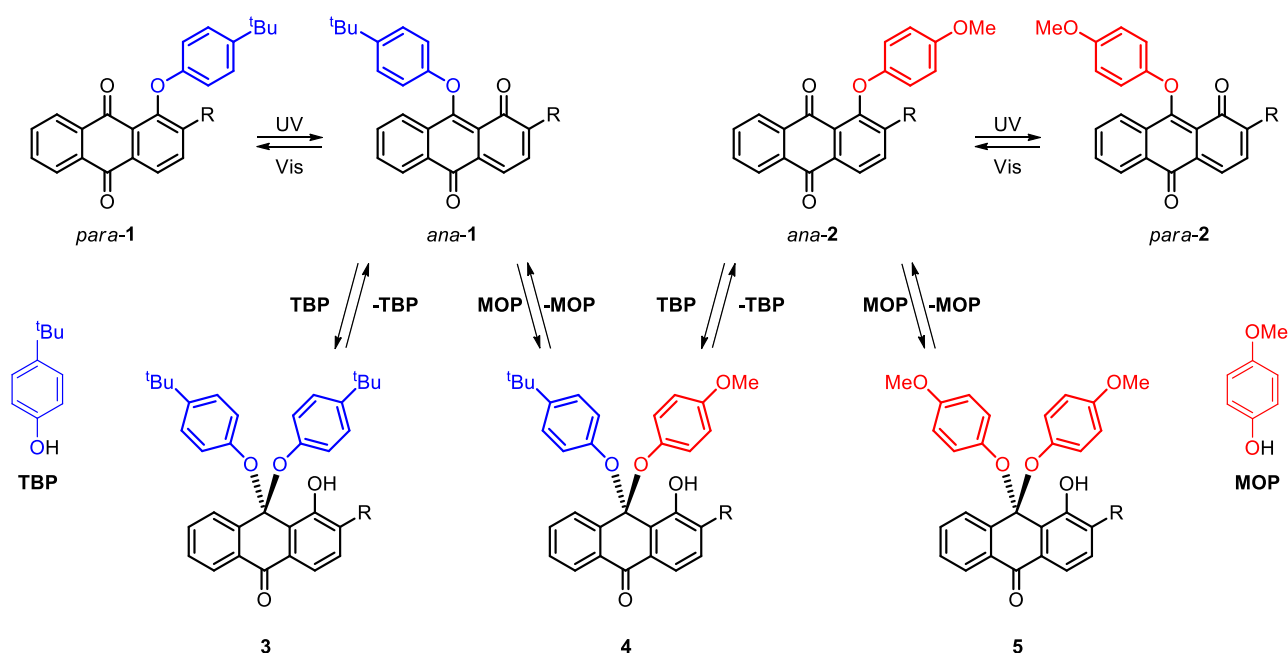

**Scheme 1.** Dynamic multicomponent system launched by the addition of 4-methoxyphenol (**MOP**) to *ana*-2.

## References

[1] *Chem. Eur. J.* **2024**, 30, e202303654

[2] *J. Am. Chem. Soc.* **2024**, 146, 3, 1799

## Acknowledgements

This work was supported by the Ministry of Science and Higher Education of the Russian Federation within the framework of the Scientific and Educational Center “Baikal” (FZZS-2024-0001).

## NEW SUGAR BEET PECTIN COMPLEXES WITH TETRACYCLINE: SYNTHESIS, PROPERTIES AND ANTIMICROBIAL ACTIVITY

*Chekunkov E.V.<sup>1</sup>, Minzanova S.T.<sup>1</sup>, Mironova L.G.<sup>1</sup>, Voloshina A.D.<sup>1</sup>, Milyukov V.A.<sup>1</sup>*

<sup>1</sup> Arbuzov Institute of Organic and Physical Chemistry, FRC Kazan Scientific Center,  
Russian Academy of Science, Kazan, Russia

Postgraduate student

[evchekunkov@gmail.com](mailto:evchekunkov@gmail.com)

**Introduction:** Currently, the search for highly effective and non-toxic antimicrobial drugs remains an urgent task [1]. It is known that the complexation of drugs with polysaccharides reduces the negative effect of the gastrointestinal tract and improve the organoleptic properties of the obtained substances [2]. In light of the aforementioned considerations, the development of novel prolonged-acting controlled-release dosage forms based on pectin, characterized by high biological activity, prolonged action and reduced ulcerogenic effect, is of significant importance and relevance. This will ensure water solubility and reduce the side effects of the drugs used.

**Methods:** A series of experiments was conducted with the objective of investigating the regularities of complexation of beet pectin with tetracycline hydrochloride. Consequently, it was possible to investigate the regularities of pectin complexation in relation to the tetracycline concentration, the pH value of the initial solution, and to determine the characteristics of the obtained products. The interaction of a 2% aqueous solution of sodium polygalacturonate (PGNa) with solutions of tetracycline hydrochloride in aqueous ethanol (varying the concentration of the drug) resulted in the synthesis of complexes I–III (Scheme 1). A preliminary aqueous solution of PGNa was obtained by treating a 2% solution of sugar beet pectin solution with a 0.625 M NaOH solution. Subsequently, the products (I–III) were precipitated with ethanol, centrifuged, and washed with ethanol to purify the complexes from physically sorbed tetracycline. They were then dried and reground.

**Results:** Complexation of sodium pectate and tetracycline hydrochloride was established by methods of IR and UV spectroscopy, thermogravimetric analysis. The stoichiometry of the obtained complexes was found, antimicrobial (bacteriostatic and bactericidal) activity was assessed in relation to test strains: *Staphylococcus aureus*, *Bacillus cereus*, *Escherichia coli*. The analysis of experimental data indicates that the complexation of PGNa with tetracycline hydrochloride against *B. cereus* and *S. aureus* does not result in a reduction in the antimicrobial activity of the drug in the complex. The minimum inhibitory concentration (MIC) of the complex III pectins is comparable to the activity of the pure drug tetracycline against *B. cereus* and *S. aureus*.

**Conclusions.** On the basis of this study, the possibility of complexation of pectin polysaccharides with the antimicrobial drug "Tetracycline" was shown to obtain non-toxic water-soluble complexes with antimicrobial action.

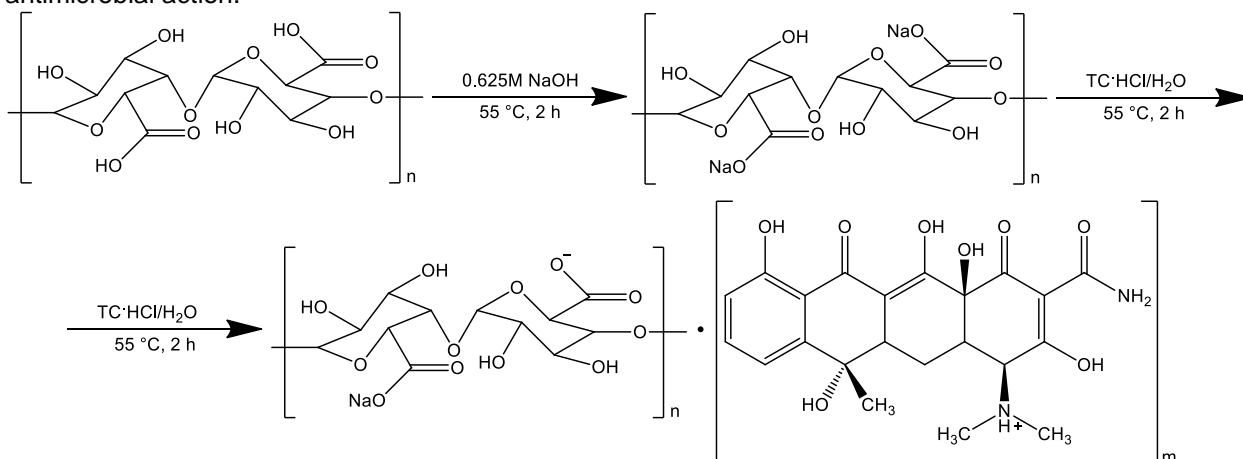

**Scheme 1.** Complexes of sugar beet pectin with tetracycline hydrochloride. Here  $n = 49$ ,  $m = 2-4$ .

### References

- [1] *Int. J. Biol. Macromol.* **2021**, 185, 49  
 [2] *Russ. Chem. Bull. (Int. Ed.)* **2020**, 69, 572

# STUDY OF THE DYNAMICS OF NANOSCALE SYSTEMS ON THE SURFACE OF CARBON MATERIALS UNDER CONDITIONS OF CATALYTIC CROSS-COUPLING PROCESSES

*Cherepanova V.A.<sup>1</sup>, Galushko A.S.<sup>1</sup>, Ananikov V.P.<sup>1</sup>*

<sup>1</sup> Zelinsky Institute of Organic Chemistry, Moscow, Russia

Postgraduate

[cherepanova@ioc.ac.ru](mailto:cherepanova@ioc.ac.ru)

Currently, the efficient production of fuels, polymers, energy, materials and agrochemicals cannot be imagined without catalysts, which are represented by heterogeneous catalysts by more than 80% for industrial applications. Heterogeneous or supported catalysts are becoming an integral component for both industrial and laboratory syntheses due to their ease of separation, reusability, and high efficiency. To further increase efficiency and consequently reduce the required quantities of catalytic noble metals for synthesis, a more precise understanding of the mechanisms of heterogeneous catalysts operation is required. One of these ways is to study the mechanisms of catalytic particles transformation on the substrate surfaces during reactions.

Research into the heterogeneous catalysis mechanisms has not stopped since its widespread use. In particular, to describe the interconversions of catalytic particles and their interaction with the substrate, the concept of a “cocktail” type of catalytic systems was formed [1], by which means it was possible to solve a number of previously formulated fundamental problems of catalysis. Subsequently, this concept made it possible to describe the modern perception of heterogeneous catalysis as the dynamic transformation of catalytic particles in solution.

When using a heterogeneous catalyst, a solid phase appears in the system, thus, for a better understanding of the processes involved, it is necessary to study not only the changes occurring in the solution, but also the influence of various factors on the metal particles deposition, as well as changes in their location on the substrate surfaces after the catalytic process. To do this, it is necessary to use not only methods for studying solutions, but also microscopic research methods (SEM, TEM, STEM), which make it possible to study the surface of catalysts at the nanometer level.

Recent studies have shown that the high dynamic activity of particles on the substrate surface is directly related to catalyst efficiency [2]. Thus, studying the structure of catalysts before the reaction and then changes in their morphology during and after the reaction will provide important information about the properties of the catalyst.

## References

- [1] *Organometallics* **2012**, *31*, 1595
- [2] *J. Am. Chem. Soc.* **2023**, *145*, 16, 9092

## Acknowledgements

This work was supported by the Russian Science Foundation (project No 22-13-00247).

# SUPRAMOLECULAR COMPLEXES OF AZO-DERIVATIVES OF THIA CALIX[4]ARENES WITH RHODAMINE DYES FOR VISUALIZATION OF HYPOXIA ON CELLS

*Churbanova E.S.*<sup>1</sup>, *Gabdrakhmanova F.B.*<sup>2</sup>, *Parfenov A.A.*<sup>2</sup>, *Kleshnina S.R.*<sup>2</sup>,  
*Solovieva S.E.*<sup>1,2</sup>, *Antipin I.S.*<sup>1,2</sup>

<sup>1</sup> A.M. Butlerov Chemical Institute, Kazan (Volga Region) Federal University, Russia

<sup>2</sup> A.E. Arbusov Institute of Organic and Physical Chemistry KazNC RAS, Russia

Student

[alyaska169@gmail.com](mailto:alyaska169@gmail.com)

Hypoxia is one of the reasons for the formation of abnormal vascular networks and the disruption of drug delivery to tumors, leading to complicating the treatment of oncology disorders. Therefore, early detection of hypoxia is necessary to prevent the development of metastases. Hypoxia is characterized by an environment with low pH and increased activity of reductive enzymes, including azoreductases. Consequently, supramolecular complexes for visualizing hypoxia have been presented in the literature. These complexes are formed through the interaction between azo-calix[4]arene in the *cone* conformation and rhodamine dyes [1,2].

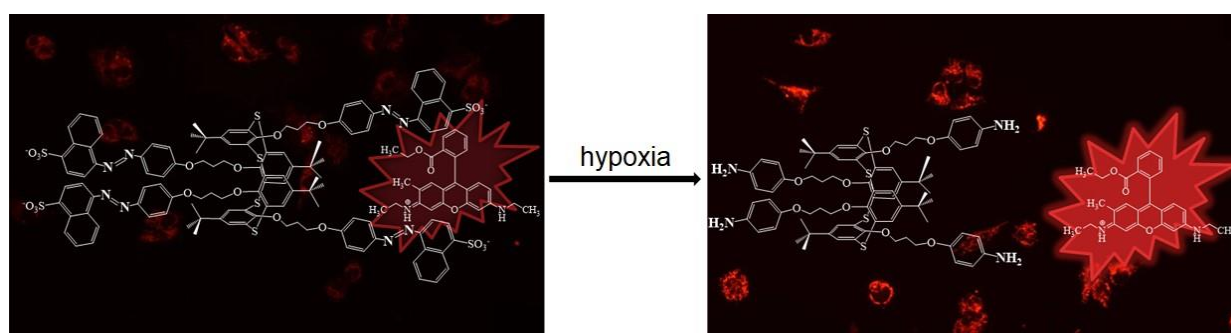

**Scheme 1.**

This work presents the synthesis of supramolecular complexes with rhodamine dyes based on tetrasubstituted azothiocalix[4]arenes in the *1,3-alternate* conformation containing sulfo- and azo groups [3]. The potential for azo bond reduction under hypoxic conditions was investigated using confocal microscopy on cells of various cancer types (Scheme 1).

## References

- [1] *Molecules* **2021**, *26*(18), 5451
- [2] *Molecules* **2023**, *28*(2), 466
- [3] *Molbank* **2023**, *1*, 1570

# INFLUENCE OF TEMPERATURE TREATMENT ON THE CATALYTIC PROPERTIES OF COBALT CATALYSTS FOR THE SELECTIVE HYDROGENATION OF P-IODONITROBENZENE

*Degtyareva V.S.<sup>1,2</sup>, Shamanaev I.V.<sup>2</sup>, Gerasimov E.Yu.<sup>2</sup>, Pakharukova V.P.<sup>2</sup>, Bukhtiyarova G.A.<sup>2</sup>*

<sup>1</sup> Novosibirsk State University, Faculty of Natural Sciences, Novosibirsk, Russia

<sup>2</sup> Boreskov Institute of Catalysis, Novosibirsk, Russia

Student

[v.degtyareva@g.nsu.ru](mailto:v.degtyareva@g.nsu.ru)

The selective hydrogenation of halogenated nitroaromatic compounds is the most widely used method for the synthesis of halogenated anilines. Haloanilines are used in the production of pharmaceuticals, dyes, pigments and agricultural chemicals as herbicides and pesticides. However, the process of reduction of nitro group may be complicated by the possibility of cleavage of a halogen [1]. There are many factors that affect this process, such as the nature of the catalyst, the method of its preparation, the substrate (the nature of the substituent and the position in the benzene ring) and the reaction conditions (T, P, solvent). The highest susceptibility to hydrodehalogenation is shown by iodine, and then by bromine, chlorine and fluorine, and depending on the position of the substituent, the selectivity decreases for meta-, para- and ortho-halo nitroaromatic compounds [1]. Catalytic hydrogenation is a very exothermic reaction, thus it is better to use a continuous-flow reactor, because it is able to provide high productivity per unit volume and per unit time, it also facilitates process optimization and reduces the risk of side reactions [2].

Heterogenous cobalt catalysts have been known to have moderate activity in the hydrogenation of substituted nitroaromatic compounds, due to which they are able to make the process selective, unlike noble metals, and also have a low cost [3]. When preparing a catalyst, special attention should be paid to temperature treatment, since it affects the degree of reduction, particle size, as well as the strength of the metal-support interaction [3], which in turn influence the catalytic activity.

The purpose of this work is to study the influence of temperature treatment (calcination and reduction) on the catalytic properties of Co/ $\gamma$ -Al<sub>2</sub>O<sub>3</sub> catalysts for the selective hydrogenation of p-iodonitrobenzene in continuous-flow reactor (Scheme 1).

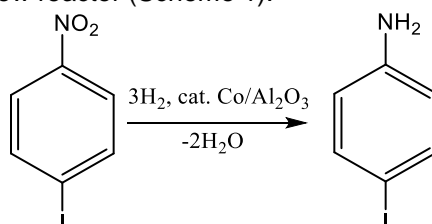

**Scheme 1.** Selective hydrogenation of p-iodonitrobenzene.

The Co/ $\gamma$ -Al<sub>2</sub>O<sub>3</sub> catalysts were prepared by impregnation of alumina granules with a melt of Co(NO<sub>3</sub>)<sub>2</sub>·6H<sub>2</sub>O at 60 °C. Further, the samples were calcined at various temperatures in the range of 250-450 °C in increments of 50 °C. The reduction temperatures also varied, being 400, 500 and 600 °C. The cobalt content in the samples was ~20%.

XRD analysis showed formation of Co<sub>3</sub>O<sub>4</sub> after calcination and metallic Co after reduction. TEM showed similar particle size distributions with mean sizes of 6–9 nm. According to the results of a series of experiments conducted in a flow reactor under the same conditions (60 °C, 5 MPa, LHSV=16 h<sup>-1</sup>, H<sub>2</sub>/feed=600 cm<sup>3</sup>/cm<sup>3</sup>), it was shown that 400 °C is optimal calcination temperature and 500 °C – optimal reduction temperature for obtaining the highest conversion (88%) of p-iodonitrobenzene. Selectivity to p-iodoaniline was >99% for all catalysts. Lower conversions after high calcination and reduction temperatures can be related to formation of spinel structures. Low temperature treatment may result in incomplete decomposition of precursors and lower reduction degree of Co.

## References

- [1] *Current Organic Synthesis*, **2012**, 9, 470-487
- [2] *Org. Process Res. Dev.* **2016**, 20, 2, 452–464
- [3] *ChemCatChem*, **2019**, 11, 724

## Acknowledgements

This work was supported by the Ministry of Science and Higher Education of the Russian Federation within the governmental assignment for Boreskov Institute of Catalysis (project FWUR-2024-0035).

## DEVELOPMENT OF NOVEL FLUORESCENT ARCHAERHODOPSIN-3 MUTANTS WITH *IN SILICO* DIRECTED EVOLUTION

*Demidov N.A.*<sup>1</sup>, *Nikolaev D.M.*<sup>2</sup>

<sup>1</sup> St. Petersburg Academic University, St. Petersburg, Russia

<sup>2</sup> St. Petersburg State University, St. Petersburg, Russia

Student

[nik.demid0v@mail.ru](mailto:nik.demid0v@mail.ru)

Directed evolution is one of the most efficient approaches for protein engineering widely applied for the development of new enzymes and protein-based sensors [1,2]. To find the protein mutant with most favorable properties, two steps are performed iteratively during directed evolution: 1) generation of a population of protein mutants using random mutagenesis; 2) screening of obtained mutants to select the variants with the largest enhancement of desired properties. The best protein mutants are used as the starting proteins to create the next generation. Although directed evolution is a costly and time-demanding technique, it allows the researchers to obtain improved proteins even when the mechanism governing optimized property is unknown.

Here, we combined genetic algorithms and computational modeling to perform *in silico* directed evolution. Computational modeling methods were used to evaluate proteins properties starting from the corresponding amino acid sequences, and genetic algorithms were used to generate new population of protein mutants based on results of computational screening. We performed *in silico* directed evolution of archaerhodopsin-3, a protein with extremely dim potential-dependent fluorescent signal [3], to enhance its fluorescence. In our recent study it was demonstrated that fluorescence enhancement can be achieved by thermodynamic stabilization of protein conformation, which differs from the ground state conformation of the wild-type protein by protonation of two titratable residues – Asp222 and Glu214 [4]. Using this data, we performed *in silico* directed evolution aimed at increasing difference in the pKa values of Asp222 and Glu214. Based on the computational analysis of predicted mutants we selected most favorable amino acid replacements and performed their experimental verification.

### References

- [1] *Chem. Rev.* **2021**, 121(20), 12384-12444
- [2] *PNAS* **2014**, 111(36), 13034-13039
- [3] *Nat. Methods* **2012**, 9(1), 90
- [4] *ACS Phys Chem Au.* **2024**

### Acknowledgements

The study was funded by the Russian Science Foundation (RSF), grant No. 23-73-00041. The research is carried out using the equipment of the shared research facilities of HPC computing resources at Lomonosov Moscow State University.

# DEVELOPMENT OF A METHOD FOR THE PREPARATION OF 5-(ALKYLTHIO)-1H TETRAZOLES

*Denisov A.A.<sup>1</sup>, Kazantsev D.A.<sup>1</sup>, Pestov A.V.<sup>1</sup>*

<sup>1</sup> I.Ya. Postovsky Institute of Organic Synthesis of the Ural Branch of the Russian Academy of Sciences (IOS UB RAS)  
[sascha.denisov.2003@gmail.com](mailto:sascha.denisov.2003@gmail.com)

5-(Alkylthio)-1H tetrazoles are widely used in organic synthesis for the preparation of various heterocyclic compounds. The possibility of their use as an activator of phosphoramidite synthesis of DNA should be emphasized in a special way. In this process, the tetrazole fragment, due to the presence of an alkylthiol substituent, acts as a soft nucleophile capable of chemoselectively interacting with the phosphoramidite fragment.

The aim of this work is to develop a single-reactor method for the preparation of mono- and disubstituted 5-(alkylthio)-1H tetrazoles from the corresponding alkyl halide, allowing the preparation of target compounds in high yields.

In the present work, a two-step method for the synthesis of mono- and disubstituted alkylthiotetrazoles based on the interaction of the corresponding alkyl halides with potassium thiocyanate in DMFA followed by [3+2] cycloaddition of hydrogen azide (see scheme) is proposed. The advantage of the method is the absence of the necessity to isolate the intermediate alkylthiocyanate from the reaction mixture. The composition and structure of the obtained compounds were confirmed by elemental analysis, <sup>1</sup>H-NMR spectroscopy, IR spectroscopy, mass spectroscopy and X-ray diffraction analysis. The purity of the compounds was confirmed by gas-liquid chromatography.

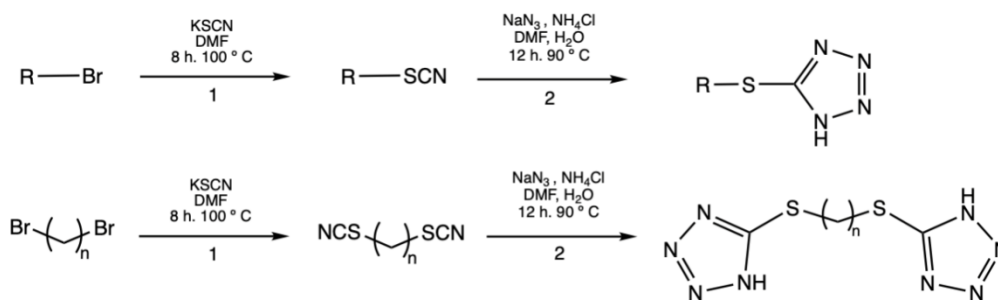

R:	Et	i-Pr	Bu	C <sub>7</sub> H <sub>15</sub>	C <sub>12</sub> H <sub>25</sub>	Tr
Yield (reaction. 1), %:	80	85	87	97	90	99
Yield (reaction. 2), %:	61	-	57	82	67	-

n:	2	3	4	5	6	10
Yield (reaction. 1), %:	90	78	62	96	78	97
Yield (reaction. 2), %:	65	69	87	57	76	78

**Scheme 1.** Synthesis of 5-(alkylthio)-1H tetrazoles.

The obtained compounds can be used as activators of phosphoramidite-induced DNA synthesis.

## Acknowledgements

This work was supported by the Russian Science Foundation (project No 24-26-00162).

# PRODUCTION OF PYRIDINE-CONTAINING NATURAL CHLORINES FOR COMBINED ANTITUMOR THERAPY

*Diachkova A.Y.<sup>1</sup>, Ostroverchov P.V.*

<sup>1</sup> RTU MIREA, Institute of Fine Chemical Technologies

Student

[annadackova336@gmail.com](mailto:annadackova336@gmail.com)

Various approaches to the treatment of oncologic diseases are currently known. Among them, chemotherapy and PDT are interesting to consider within the framework of this article. These treatment methods have both unconditional advantages and disadvantages.

The main advantage of the chemotherapeutic treatment approach is the generalized effect on tumor foci in various organs through the injection of the drug into the blood. At the same time, the disadvantages are multiple drug resistance, side effects of the chemotherapeutic agent on healthy cells of the body, and insignificant accumulation in the foci.

The main advantages of PDT include the gentle nature of the treatment approach and the absence of serious complications. However, a significant disadvantage is that it is not suitable for the treatment of malignant lesions located in areas inaccessible to irradiation.

The method of combined PDT and chemotherapy helps to overcome these disadvantages and, as a result, more effective treatment of tumor diseases.

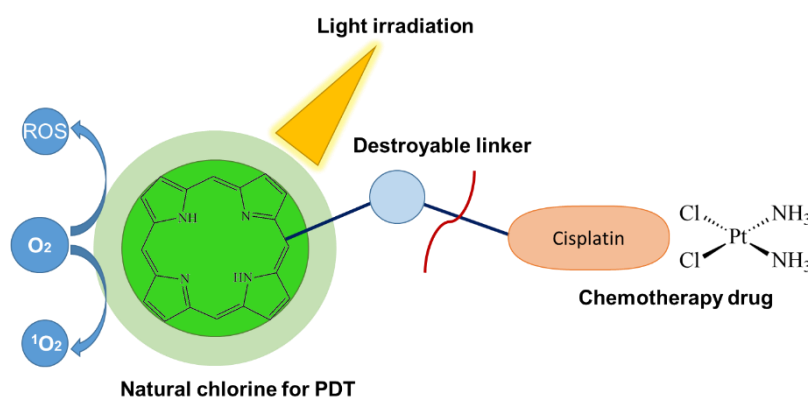

**Scheme 1.** Principle scheme of the research.

In the course of research work, derivatives of natural chlorines containing a pyridine moiety were prepared for further chelation with cisplatin. Pyridine fragments were introduced through the formation of hydrazides and imines to confer lability in the acidic environment characteristic of the tumor cell region.

The structures of the obtained conjugates were proved by confirmed by a complex of physicochemical methods, including ESI mass spectrometry and NMR spectroscopy.

## References

[1] *J. Porphyr. Phthalocya.* **2023**, *27*, 728-740

[2] *Biophys. Rev.* **2022**, *14(4)*, 941-963

## Acknowledgements

This research was funded by Russian Scientific Foundation (RNF), grant number 23-73-01276.



## SYNTHESIS OF CHITOSAN-HYDROXYCINNAMIC ACID CONJUGATES

*Dolya D.A.*<sup>1</sup>, *Dubashynskaya N.V.*<sup>1</sup>, *Skorik Y.A.*<sup>1</sup>

<sup>1</sup> Institute of Macromolecular Compounds of the Russian Academy of Sciences, St. Petersburg, Russia  
Student

[lemkke1291@gmail.com](mailto:lemkke1291@gmail.com)

In search of a new effective strategy to modify biopolymers to improve their adhesion to the mucosa, researchers have recently turned to the production of catechol-derived polymers. The use of this approach has been called mussel-inspired chemistry, because structures containing catechol moieties are responsible for the extremely strong adhesive ability of various marine animals (e.g. mussels), even in aqueous environments in the presence of competing water molecules, because the catechol fragment binds to mucins by forming hydrogen bonds due to the presence of hydroxyl groups in the ortho position [1].

Chitosan was chosen as the polymeric carrier for catechol. Chitosan is a linear polysaccharide derived from chitin and consists of D-glucosamine and N-acetyl-D-glucosamine monomers. It is a non-toxic biopolymer that can be used in the pharmaceutical, food and textile industries, etc [2]. Caffeic acid (3,4-dihydroxycinnamic acid) was chosen as the catechol component because it is readily available.

The synthesis of chitosan-caffeic acid conjugates was carried out by two methods: the carbodiimide activation method and the acyl chloride method. The carbodiimide activation method involves catalytic processes using two reagents, EDC (1-ethyl-3-(3-dimethylaminopropyl)carbodiimide) and NHS (N-hydroxysuccinimide), which activate the carboxyl group of caffeic acid for subsequent binding to the amino group of chitosan. The acyl chloride method is based on the nucleophilic attack of caffeoyl chloride on the amino group of chitosan. The structure of the chitosan-caffeic acid conjugates was confirmed by NMR spectroscopy. The degree of substitution was compared between the two methods. The chitosan-caffeic acid conjugates were also found to have obvious mucoadhesion, oxidation resistance, chelating and coordinating abilities, and antibacterial properties.

### References

- [1] *Catalysts* **2020**, *10*(5), 584,  
[2] *Int. J. Biol. Macromol.* **2024**, *256*(2), 128488

### Acknowledgements

This work was financially supported by the St. Petersburg Science Foundation (project No. 23-RB-03-07).

# PALLADIUM-CATALYZED ALLYLIC SUBSTITUTION OF PRIMARY AND SECONDARY AMINES WITH ALLYL FORMATE

*Durakov S.A.*<sup>1</sup>, *Magasumov A.A.*<sup>1</sup>, *Flid V.R.*<sup>1</sup>

<sup>1</sup> MIREA - Russian Technological University, Lomonosov Institute of Fine Chemical Technologies, Moscow, Russia

Associate professor, Ph.D.

[s.a.durakov@mail.ru](mailto:s.a.durakov@mail.ru)

Amines and their derivatives are widely used in the synthesis of various pharmaceuticals, dyes, agrochemicals, and polymers. Many of them are of great importance as fundamental building blocks for production in bulk and fine chemistry, as well as for the synthesis of numerous biologically active molecules such as alkaloids, amino acids, and nucleotides. Among the various types of amines, allylamines are of considerable interest because they are often structural fragments present in various biologically active compounds. Some examples of such compounds are antifungals (Naftiphine), calcium channel blockers (Flunarizine), components of advanced intermediates for ring-closing metathesis, asymmetric isomerization, and the general synthesis of several natural products [1].

Currently, a fairly large number of methods have been developed for the preparation of allylamines, most of which involve the interaction of amines with reactive electrophiles. Nevertheless, these processes of obtaining allylamines are frequently accompanied by side reactions such as overalkylation, elimination of unwanted products, isomerization, etc. [2] Among the methods for producing allylamines in last year's transition metal-catalyzed allylic substitution reactions of allylic substrates have shown themselves to be some of the most versatile reactions. For example, the Tsuji-Trost allylation reaction with allylic ethers turned out to be extremely effective and useful [3]. However, procedures involving activated allylic species generate stoichiometric quantities of waste material, thus making these procedures environmentally unsuitable. In recent years, the use of allylic substrate alcohols for substitution reactions has gained significant traction to counteract this problem. These methodologies avoid the generation of unwanted byproducts and thus provide more environmentally benign and economical procedures for the synthesis of target compounds. Nevertheless, the application of this approach is often limited by the choice of substrate. Often, only amine-aryl derivatives containing one, two, or more benzene rings enter the reaction. In addition, similar systems have disadvantaged such requirements as high heating, an inert atmosphere, a long time of reaction, and the use of expensive ligands [4]. In this connection, the development of new and improved catalysts for the synthesis of allylamines is still of constant interest.

Herein, we wish to report the proof-of-concept for the use of allyl formates as transfer allylation agents in primary and secondary amines allylation. These compounds are easily accessible via an esterification of allyl alcohols with formic acid and as a waste product of allylation only CO<sub>2</sub> is formed as a gaseous and traceless linker.

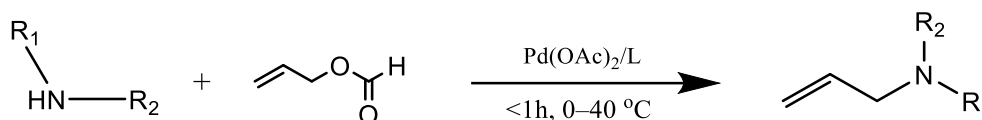

**Scheme 1.** An example of secondary amines allylation with allyl formate.

Allyl formate and its analogues highly selectively enter into the allylation reaction, giving a high yield of target products up to 98% and tiny amount of by-products. Reactions occur in mild conditions: in the air, at room temperature, in a short time. Allyl formates react indefinitely with both aromatic amines and branched linear amines, which allows the reaction to be used to obtain allylamines that were previously not used in production or research. For example, the first synthesized allyl-substituted derivatives of amino norbornenes and amino adamantanes were reported.

## References

- [1] *Chem. Sci.* **2023**, *14*, 8644
- [2] *ChemistryOpen.* **2021**, *10*, 1166
- [3] *J. Org. Chem.* **2022**, *87*, 2864
- [4] *Chem. Soc. Rev.* **2015**, *44*, 7929

## Acknowledgements

This work was supported by the Russian Science Foundation (project No 23-73-00123).

## SYNTHESIS OF NOVEL CARBORANYL-CARBENE COMPLEXES OF RHODIUM

*Erdelyi K.E.*<sup>1,2</sup>, *Timofeev S.V.*<sup>2</sup>, *Anufriev S.A.*<sup>2</sup>, *Nasyrova D.I.*<sup>3,4</sup>, *Sivaev I.B.*<sup>1,2</sup>

<sup>1</sup> National Research University "Higher School of Economics", Moscow, Russia

<sup>2</sup> A. N. Nesmeyanov Institute of Organoelement Compounds, Russian Academy of Sciences, Moscow, Russia

<sup>3</sup> N.D. Zelinsky Institute of Organic Chemistry, Russian Academy of Sciences, Moscow, Russia

<sup>4</sup> Moscow Institute of Physics and Technology (National Research University), Dolgoprudny, Moscow Region, Russia  
Master

[erd.cyrill@gmail.com](mailto:erd.cyrill@gmail.com)

Carboranes are polyhedral boron-carbon molecular clusters that are attractive as ligands due to their unique geometry, electronic properties and wide functionalisation options<sup>1</sup>. N-heterocyclic carbenes (NHCs) are monodentate, strong two-electron donor ligands that have become popular due to the ability to fine-tune their steric and electronic effects by modifying nitrogen and framework substituents<sup>2</sup>.

Despite the worldwide popularity of N-heterocyclic carbene ligands, carboranyl-carbene ligands are rather poorly studied, although they can exhibit interesting catalytic and bioactive properties<sup>3,4</sup>.

In this work, we have synthesised rhodium carborane-carbene complexes based on the icosahedral 1, 2-dicarba-*closo*-carborane (ortho-carborane) (Scheme 1) and 7, 8-dicarba-*nido*-carborane.

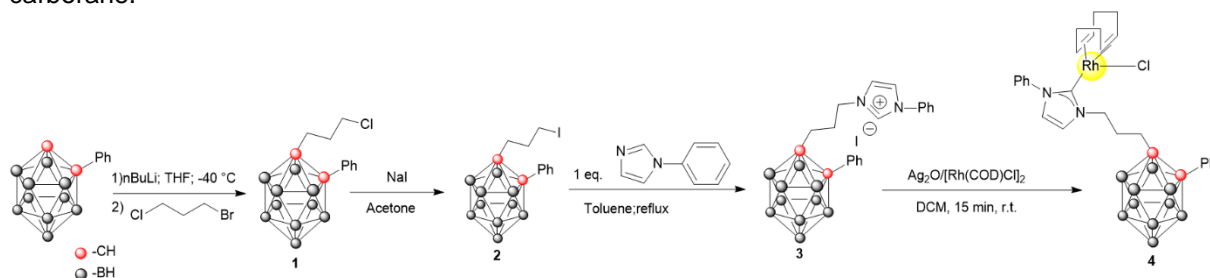

**Scheme 1.** The scheme of synthesis of one of the rhodium carborane-carbene complexes.

All of compound obtained were isolated and fully characterized by <sup>1</sup>H NMR, <sup>11</sup>B NMR, <sup>13</sup>C NMR spectroscopy, high resolution mass spectrometry and SCXRD.

### References

- [1] *Carboranes* 2016, 21
- [2] *Nature* **2014**, 510(7506), 485–496
- [3] *Dalt. Trans.* **2016**, 45(40), 15818–15827
- [4] *Organometallics* **2019**, 38(12), 2530–2538

# STUDY OF THE REACTION OF CYANOCOBALAMIN IN THE PRESENCE OF FENTON'S REACTIVE

*Erina A.A.<sup>1</sup>, Borodulin V.B.<sup>1</sup>, Zybin D.I.<sup>2</sup>, Ishchenko A.A.<sup>1</sup>*

<sup>1</sup> M.V. Lomonosov Institute of Fine Chemical Technologies, MIREA – Russian Technological University, Moscow, Russia

<sup>2</sup> OOO «PHARMAPARK», Moscow, Russia

PhD student

[aaerina@mail.ru](mailto:aaerina@mail.ru)

Vitamin B12 is a key molecule in the synthesis of hemoglobin and the maturation of red blood cells. The deficiency of this vitamin among the population is, on average, 3-16%; in older people it can reach up to 93% [1]. A lack of vitamin B12 can lead to the development of anemia. Under hypoxic conditions, oxidative stress develops, during which oxygen-containing radicals are formed.

In this work, we studied a model of oxidative stress - the interaction of cyanocobalamin (5·10<sup>-3</sup> mol/l) with Fenton's reagent - hydrogen peroxide (0.07 mol/l) and iron (II) sulfate (0.1 mol/l). Optical absorption at characteristic wavelengths of cyanocobalamin 361 and 551 nm for test solution No. 1 (reagent ratio B<sub>12</sub>CN/H<sub>2</sub>O<sub>2</sub>/Fe<sup>2+</sup> 40/40/20 μl) decreased by 72% and 22%, respectively. For test solution No. 2 (B<sub>12</sub>CN/H<sub>2</sub>O<sub>2</sub>/Fe<sup>2+</sup> 40/20/20 μl) – by 16 and 9%, respectively.

Chromatographic separation of the two reaction mixtures was carried out on a chromatograph (Thermo Scientific Vanquish Flex UHPLC) using an Acclaim RSLC 120 C18 column (2.2 μm, 2.1x150mm). There is a significant decrease in the main signal for cyanocobalamin and the concomitant formation of new signals forming peaks and groups of peaks. The main exit times were 0.970, 6.470, 6.733, 7.890 minutes.

Selected 7 fractions of test solution No. 2 (Scheme 1), which passed through a chromatographic column, were analyzed on an Agilent Technologies 7900 inductively coupled plasma mass spectrometer for the presence of elements such as cobalt, phosphorus and iron. It was shown that cobalt and iron are present in all fractions, but phosphorus is absent in fraction No. 4, which may indicate the detachment of the 5-deoxyadenosyl residue from the molecule. On the contrary, fractions No. 3 and No. 5 contain a sufficient amount of phosphorus.

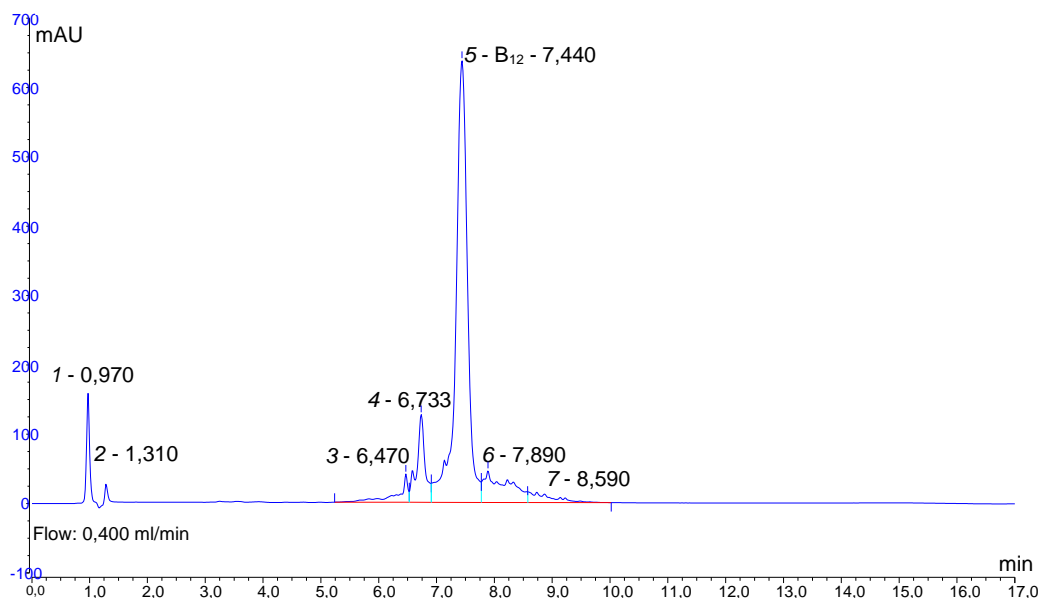

**Scheme 1.** Chromatographic spectrum of test solution No. 2.

## References

[1] *J. Prev. Med. Public Health.* **2023**, 26(1), 109

## FLUORESCENT SWITCHES BASED ON *PERI*-ARYLOXYQUINONES

*Faizdrakhmanova A.A.*<sup>1,2</sup>, *Bykov V.N.*<sup>1,2</sup>, *Mikhailov I.E.*<sup>3</sup>, *Lvov A.G.*<sup>1,2</sup>

<sup>1</sup> A.E. Favorsky Irkutsk Institute of Chemistry SB RAS, Irkutsk, Russia

<sup>2</sup> Irkutsk National Research Technical University, Irkutsk, Russia

<sup>3</sup> Southern Federal University, Rostov-on-Don, Russia

Master

[ann-allexeevna@mail.ru](mailto:ann-allexeevna@mail.ru)

Fluorescent switches are promising for biological imaging, including super-resolution fluorescence microscopy, the creation of anti-counterfeiting tools and fluorescent sensors. [1-3] During last years, a large number of such photo-functional compounds based on diarylethenes, spiropyranes, azobenzenes, dihydroazulenes, imidazole dimers and fulgides have been developed.

In our laboratory, we study photochromic *peri*-aryloxyquinones (PAQs), which switch under the UV and visible light. [4] In the process of PAQs switching, the migration of the aryl fragment (aryltropy) occurs with the formation of *ana*-quinones. Two works are known in which the fluorescence is controlled by switching PAQs. [5,6] We obtain new fluorescent PAQs *para*-2 containing a fluorescent oxadiazole fragment. They were synthesized by the interaction of the available chloro-naphthacenoquinone **1** and the corresponding phenol derivatives. The photochromic and fluorescent properties of *para*-2 compounds will be discussed in the report (including calculations of the quantum yield of photoisomerization and fluorescence).

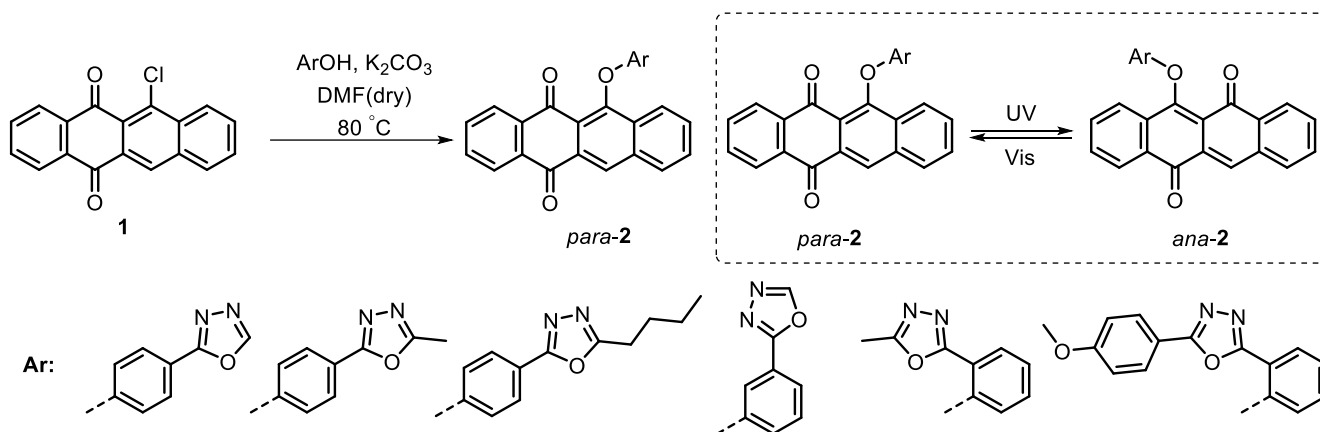

### References

- [1] *Chem. Commun.*, **2023**, 59, 660-669
- [2] *NPG Asia Mater*, **2018**, 10, 859–881
- [3] *J. Mater. Chem. C*, **2023**, 11, 15393-15411
- [4] *Chem. Eur. J.*, **2024**, 30
- [5] *J. Am. Chem. Soc.*, **2001**, 123 (1), 177-178
- [6] *Adv. Mat.*, **2004**, 16: 922-925

### Acknowledgements

This work was supported by the Ministry of Science and Higher Education of the Russian Federation in scientific and educational center of the world level "Baikal" (FZZS-2021-0006).

## DE NOVO DESIGN BASED ON MONTE-CARLO TREE SEARCH

*Fatykhova A.A.*<sup>1</sup>, *Madzhidov T.I.*<sup>2</sup>

<sup>1</sup> Intelligent Chemical Robotics Laboratory, A.M. Butlerov Institute of Chemistry, Kazan Federal University, Kazan, Russia

<sup>2</sup> Independent researcher, United Kingdom  
Junior researcher  
[adafatyhova@kpfu.ru](mailto:adafatyhova@kpfu.ru)

Modern drug development involves the use of high-tech methods, including machine learning methods. In the last few years, there has been great progress in machine learning for de novo drug design. Although, a serious drawback of modern generative approaches is that proposed molecule structures cannot be experimentally tested due to problems with their synthesis, since the models don't offer pathways for the synthesis of potentially successful molecules. In this work, we present an MCTS-based tool for de novo design that can be used for prediction of the synthesis path of target compound, as well as prediction similar to target molecules.

Scheme 1 represents a set of similar molecules that were predicted when it attempted to synthesize betaxolol and its analogues.

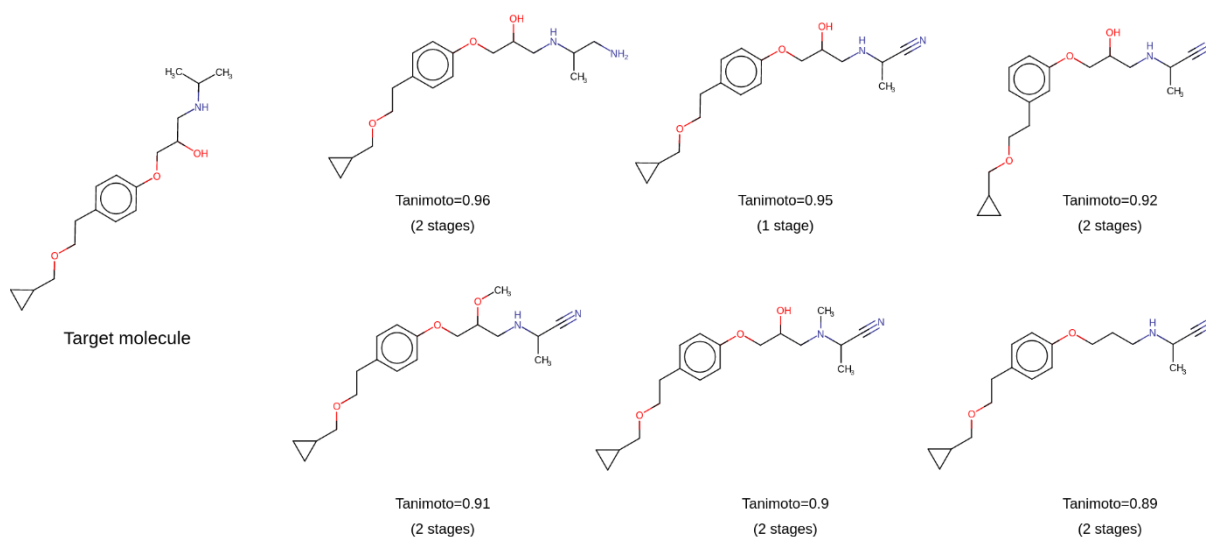

**Scheme 1.** Similar products found for betaxolol - cardioselective beta blocking agent.

Current implementation is based on a collection of 604785 commercially available building blocks from ZINC database and 2597 reaction transformation templates automatically extracted from the USPTO reaction database.

### Acknowledgements

This work was funded by the subsidy allocated to Kazan Federal University for the state assignment in the sphere of scientific activities FZSM-2024-0002.

FORMATION OF PYRROLE AND 1*H*-CYCLOPENT[*C*]PYRID-1-ONE DERIVATIVES BY DBU-MEDIATED TRANSFORMATIONS OF 4-ALKYL-2-AZABUTA-1,3-DIENES

*Filippov I.P.,<sup>1</sup> Rostovskii N.V.,<sup>1</sup> Zakharov T.N.,<sup>1</sup> Grishin A.V.,<sup>1</sup> Novikov M.S.,<sup>1</sup> Khlebnikov A.F.<sup>1</sup>*

<sup>1</sup> St. Petersburg State University, St. Petersburg, Russia

PhD student

[i.filippov@spbu.ru](mailto:i.filippov@spbu.ru)

2-Azabuta-1,3-dienes are effective building blocks for the construction of a wide range of heterocyclic structures such as dihydroazetes, pyrroles and azines along with their fused analogues. A convenient synthetic approach to obtain 2-azabutadienes is the reaction of diazo compounds **1** with 2*H*-azirines **2** or isoxazoles catalyzed by rhodium(II) complexes [1].

Previously, we have shown that 4-alkyl-2-azabuta-1,3-dienes **3** enter into 1,5-cyclization under the action of the base DBU to form 1-pyrroline derivatives **4**. With the disclosed approach, we were able to obtain a series of 1-pyrrolines with high yields and a wide range of introduced substituents (Fig. 1, path a). Substituents introduced in the positions 3 and 4 of the pyrroline ring are alkyl and aryl groups, ester and amide moieties and even hydroxyl; positions 2 and 5 can be substituted with aryl group. The mechanism of transformation was studied, and one of the intermediates on the way to pyrrolines is the 1-azabutadiene, formed in the reaction of 2-azabutadiene with DBU.

When the cyclopentyl substituent was introduced into the fourth position of azabutadiene **3'**, DBU promoted another cyclizations – instead of pyrroline, cyclopentapyridone derivatives **5** and 3-hydroxypyrrole **6** were obtained as products of 7-exo-trig and 5-exo-trig cyclizations respectively (Fig. 1, path b). In moderate yields, we synthesized a series of pyridone derivatives, but the reaction turned out to be limited in terms of the introduced substituents. The mechanisms of formation of pyrrolines **4**, pyridones **5**, and pyrroles **6** were proposed with the aid of control experiments and quantum chemical calculations.

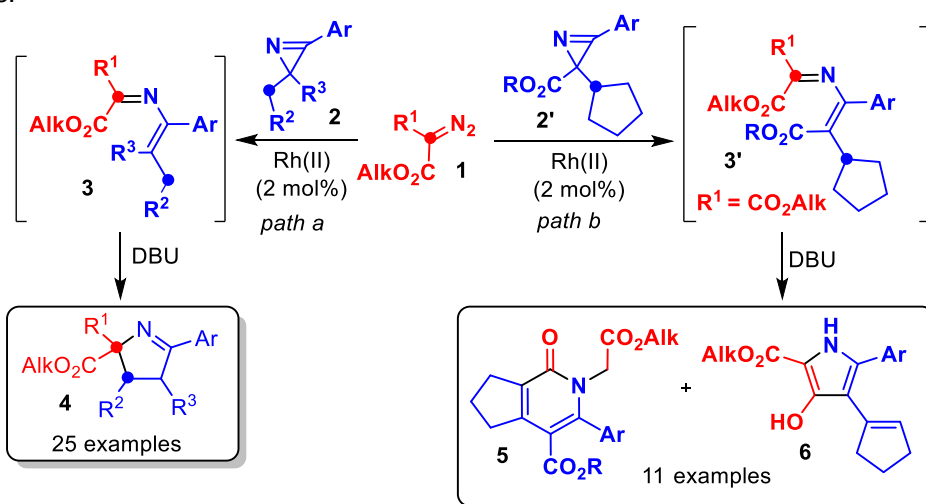

**Scheme 1.** DBU-mediated cyclizations of 4-alkyl-2-azabuta-1,3-dienes.

## References

- [1] *Organics* **2021**, 2, 213  
 [2] *J. Org. Chem.* **2022**, 87, 8835

## Acknowledgements

This work was supported by the Russian Science Foundation, project № 22-73-10184. This research used resources of the Magnetic Resonance Research Centre, Chemical Analysis and Materials Research Centre and Centre for X-ray Diffraction Studies of the Research Park of St. Petersburg State University.

# FLUORESCENT PHOTOPROTECTIVE GROUPS BASED ON 1,2,3-TRIAZOLYLTHIAZOLE: SYNTHESIS AND PHOTOPHYSICAL PROPERTIES

*Fomin T.O.<sup>1</sup>, Krasilnikov V.A.<sup>1</sup>, Belskaya N.P.<sup>1</sup>*

<sup>1</sup> Ural Federal University, Ekaterinburg, Russia

PhD Student

[timurfomin74@gmail.com](mailto:timurfomin74@gmail.com)

The important field of the application of organic fluorophores are their using in biology and medicine for the design and synthesis of photoprotecting group (PPGs) for targeted intracellular delivery of drugs, diagnostic agents and biomolecules. Fluorescent PPGs have a major advantage over non-fluorescent ones because its can provide visualization and manage the molecules releasing in real time [1].

We obtained a series of hybrid molecules based on fluorescent 1,2,3-triazolylthiazole and biomolecules containing a carboxyl group. The alkylation of glycine, leucine, methionine, as well as biotin, *gamma*-aminobutyric acid and chloroambucil was carried out by 4-(chloromethyl)thiazoles in DMF in the presence of cesium carbonate. New photocage systems showed good photophysical properties in binary systems DMSO-water, DMSO-PBS and biological media. A study of photodissociation of the C-O bond showed fast and effective releasing of the biomolecule upon visible light.

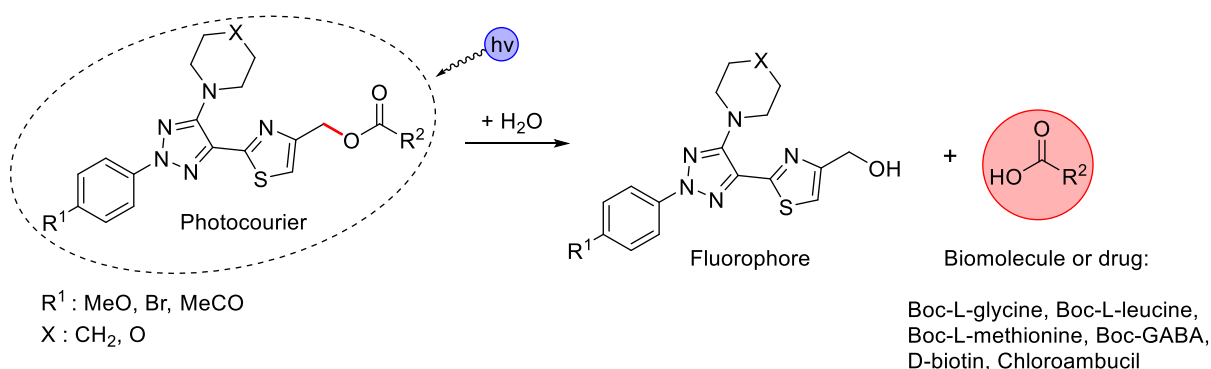

**Scheme 1.** Photodissociation of a photocourier based on 1,2,3-triazolylthiazole.

The structure of the obtained compounds was confirmed by NMR (<sup>1</sup>H, <sup>13</sup>C), mass and IR spectra.

## References

[1] *Angew. Chem., Int. Ed.* **2013**, *52*, 13803-13807

## Acknowledgements

The research was carried out with the financial support of the Ministry of Science and Higher Education of the Russian Federation within the framework of the Development Program of the Ural Federal University named after the first President of Russia B.N. Yeltsin in accordance with the strategic academic leadership program "Priority 2030" and "UrFU academic mobility program".



# THE REACTIVITY OF EPICHLOROHYDRIN TOWARD CARBON DIOXIDE IN PRESENCE OF ANION EXCHANGE RESINS

*Gabov I.S.<sup>1</sup>, Pestov A.V.<sup>1,2</sup>*

<sup>1</sup> Postovsky Institute of Organic Synthesis, Ural Branch of the Russian Academy of Sciences, Ekaterinburg, Russia

<sup>2</sup> Ural Federal University, Ekaterinburg, Russia

Graduate student

[ivan.s.gabov@gmail.com](mailto:ivan.s.gabov@gmail.com)

Cyclic organic carbonates have recently been widely used in industry, for example as organic solvents and reagents in organic synthesis and multifunctional components of electrical devices [1]. Interaction of carbon dioxide and oxirane derivatives is important method to obtain cyclic carbonates because it is both good yield of cyclic carbonates and effective carbon dioxide utilization method [2].

The aim of this research was to investigate catalytic activity of Russian industrial anion exchange resins in the reaction between epichlorohydrin – one of the most industrially significant oxirane derivative – and carbon dioxide.

The interaction of carbon dioxide and epichlorohydrin was carried out in the stainless-steel high-pressure reactor at different temperatures and pressures and number of anion exchange resins.

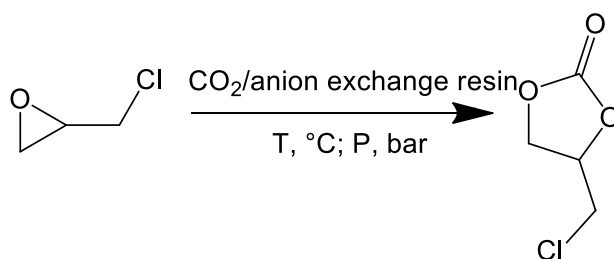

**Scheme 1.** Reaction of epichlorohydrin with carbon dioxide.

During the experiments, it was found that the most effective anion exchange resin in investigated reaction was AW-17-8 with conversion of epichlorohydrin to chloromethylethylene carbonate 86 %.

In summary, we have presented that Russian industrial anion exchange resins could be good heterogeneous catalysts to obtain cyclic carbonates from carbon dioxide and oxirane derivatives.

## References

[1] *Russ. J. Org. Chem.* **2020**, *56*, 1852-1861

[2] *Russ. Chem. Bull.* **2023**, *72(12)*, 2809-2814

# SYNTHESIS OF NOVEL MESOIONIC PYRIDAZIN-1-IUM-3-OLATES

*Gaiazov E.R., Anisovich K.V., Ivanova O.A.*

Moscow State University, Moscow, Russia

Ph.D. student

[ernal.gaiazov@chemistry.msu.ru](mailto:ernal.gaiazov@chemistry.msu.ru)

Mesoionic compounds are one of the archetypes of heterocycles that, by definition, cannot be represented by any Lewis structure not involving charge separation and comprising a sextet of electrons. The most typical mesoionic compounds are five-membered rings such as sydnones, munchnones, etc [1]. However, examples of six-membered mesoionic compounds exist too, the most studied ones among them are pyridin-1-ium-3-olates. Here, we report a new method for the synthesis of underexplored representatives of six-membered mesoionic compounds, i.e., pyridazin-1-ium-3-olates [2].

In this work, we developed a new effective approach for the synthesis of pyridazin-1-ium-3-olates **4** via DDQ - mediated oxidation of the corresponding 3-oxohexahydropyridazines **3**. The intermediate products **3** were obtained by the Lewis-acid induced reaction of donor-acceptor cyclopropanes **1** with arylhydrazines **2**. This synthetic strategy features mild conditions, high functional group tolerance and high yields of pyridazin-1-ium-3-olates **4**.

To further simplify the synthesis of target mesoionic compounds, we studied the possibility of their preparation using *one-pot* procedure directly from DA cyclopropanes. We found that this synthetic protocol allows obtaining pyridazin-1-ium-3-olates **4** in high yields.

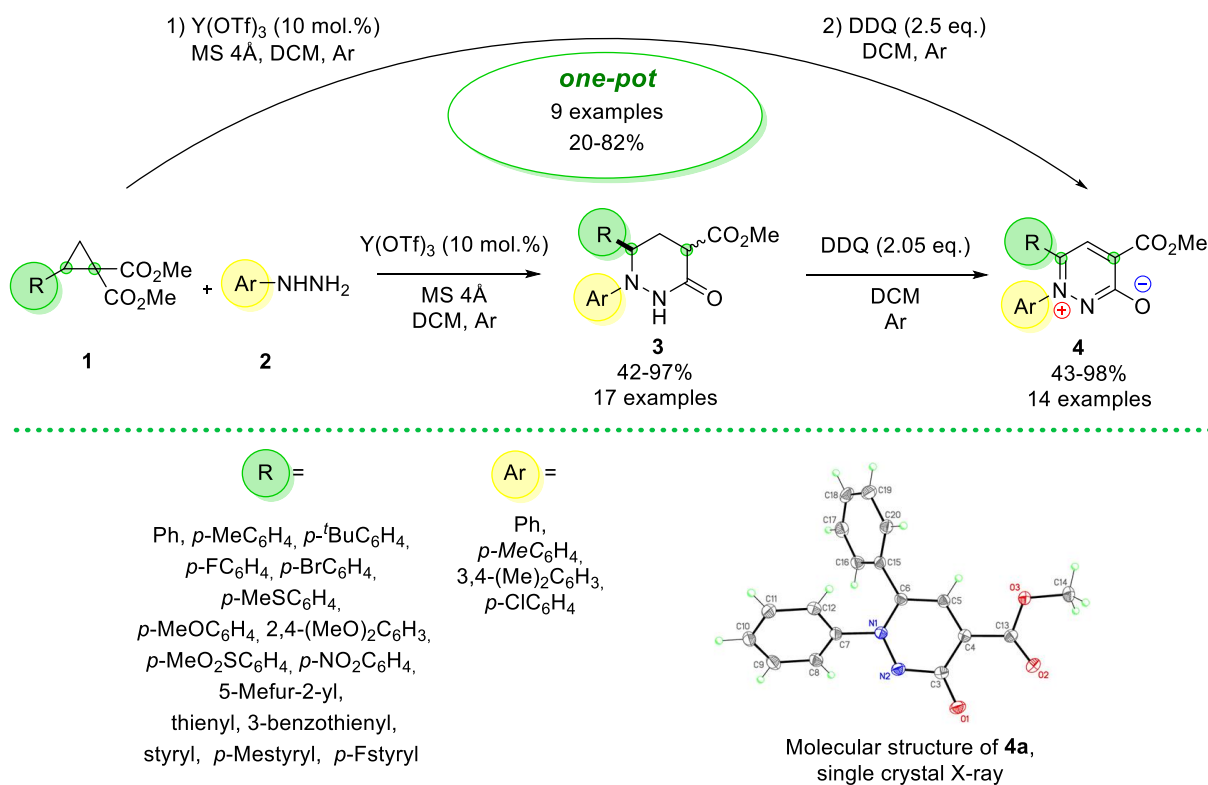

**Scheme 1.** Synthesis of pyridazin-1-ium-3-olates.

## References

- [1] *Adv. Heterocycl. Chem.* **2003**, *85*, 67-171  
[2] *J. Chem. Soc., Perkin Trans* **1975**, *1*, 1506-1514

## Acknowledgements

This work was supported by the Russian Science Foundation (project No 21-73-20095).

## ALKYLATION OF PHOSPHINE SELENIDES

*Galiakhmetov S.A.*<sup>1</sup>, *Tonkoglazova D.I.*<sup>1</sup>, *Mulloyarova V.V.*<sup>1</sup>, *Antonov A.S.*<sup>2,3</sup>

<sup>1</sup> St. Petersburg State University, St. Petersburg, Russia

<sup>2</sup> University of Regensburg, Regensburg, Germany

<sup>3</sup> Ludwig Maximilian University of Munich, Munich, Germany

Student

[st117534@student.spbu.ru](mailto:st117534@student.spbu.ru)

Since the first synthesis of phosphine selenides ( $R_3P=Se$ ,  $R = \text{alkyl, aryl}$ ), a vast number of reports concerning their application in various fields of chemical research have been published in literature. One of the key features of phosphine selenides is the presence of two NMR-suitable nuclei isotopes:  $^{31}P$  and  $^{77}Se$ . Together with the fact that phosphine selenides can directly participate in numerous non-covalent interactions [1], this makes phosphine selenides perfect probes for the NMR studies of these processes. Here we report unprecedentedly easy alkylation of phosphine selenides and NMR investigation of this transformation.

It was found that treatment of phosphine selenides ( $R = \text{Ph, } n\text{-Bu, Et}$ ) with excess of dimethyl sulfate or iodomethane leads to slow formation of corresponding alkylated products (Scheme 1). Comparison of the  $^{31}P\{^1H\}$  NMR spectra of the initial phosphine selenide and the alkylated product demonstrates slight high field chemical shift (from 35.3 to 36.3 ppm in the case of  $R = \text{Ph}$ ), as well as a dramatic change of  $J(^{31}P^{77}Se)$  coupling constant from 730 to 453 Hz (Figure 1). The latter demonstrates the transformation of double  $P=Se$  bond into single one.

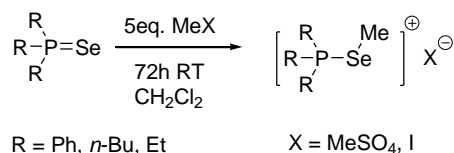

**Scheme 1.** Alkylation of phosphine selenides

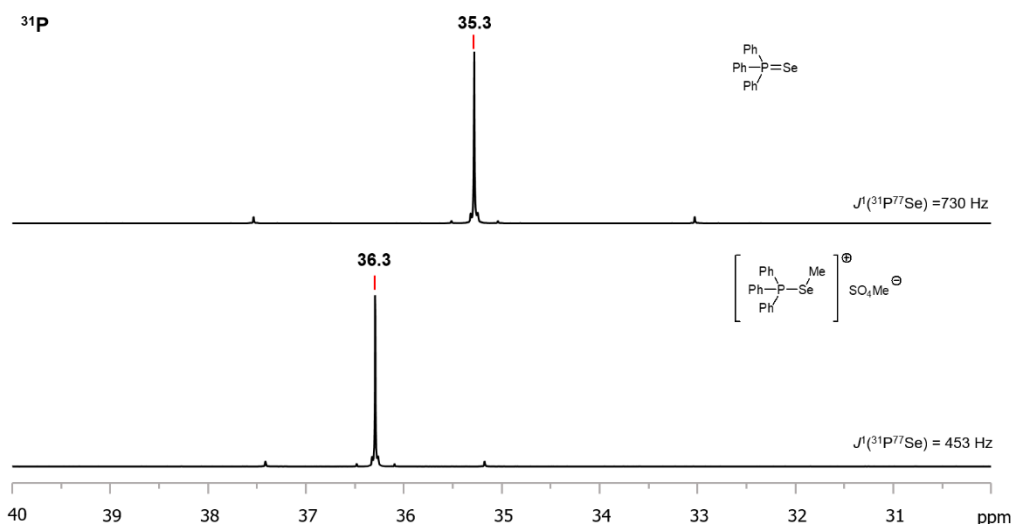

**Figure 1.**  $^{31}P$  NMR spectra of  $Ph_3P=Se$  (top) and the product of its alkylation with  $Me_2SO_4$  (bottom),  $CDCl_3$ , 298 K.

### References

[1] *Chempluschem*, **2023**, e202200284

### Acknowledgements

This work was supported by the Russian Science Foundation (project No 23-13-00095).

# NEW FLUORESCENT CYCLOALKYNE WITH C2 SYMMETRY: SYNTHESIS AND APPLICATION IN BIOORTHOGONAL CHEMISTRY

*Galkin E.S.<sup>1</sup>, Vidyakina A.A.<sup>1</sup>, Danilkina N.A.<sup>1</sup>*

<sup>1</sup> St. Petersburg State University, St. Petersburg, Russia  
Student

[galkin.egor2003@mail.ru](mailto:galkin.egor2003@mail.ru)

Bioorthogonal click reactions represent a convenient tool for the modification of molecules in vitro and in vivo. Strain-promoted azide-alkyne cycloaddition (SPAAC) is one of the most popular class of these reactions [1]. Functionalized strained cyclic alkynes, predominantly cyclooctynes and cyclononynes, are a highly attractive and useful class of reagents in this click reaction. Despite the extensive literature describing various cycloalkyne reagents, fluorescent cycloalkynes exhibiting C2 symmetry are limited to bicyclononyne (BCN) derivatives [2]. At the same time, such cycloalkyne reagents are very promising as they provide a single regioisomer in SPAAC, which is important in the synthesis of biologically active compounds and other triazoles with useful properties.

The aim of this work is to develop a method for synthesizing a fluorescent cycloalkyne with C2 symmetry and demonstrate its use for identifying azido-amino acids. Diazacyclononyne [3], containing two dansyl fragments (**DADS**), was chosen as a target structure (Scheme 1).

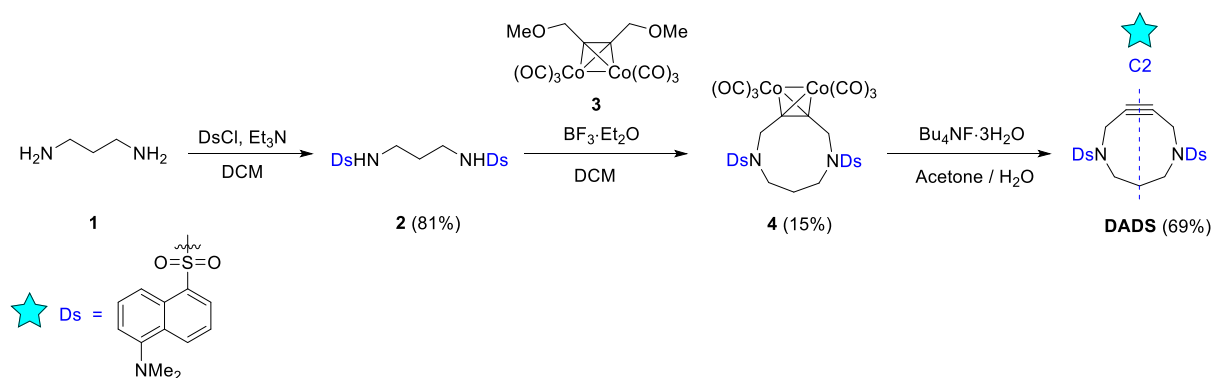

**Scheme 1.** The synthesis of symmetrical fluorescent diazacyclononyne **DADS**.

The synthesis of the **DADS** involves the sulfonylation of propane-1,2-diamine **1** using dansyl chloride with the formation of bis(dansyl) derivative **2**, the formation of Co-complex **3**, the intermolecular Nicholas cyclization between complex **3** and bisdansyl derivative **2** with the formation of cyclic Co-complex **4**, and the final decomplexation of **4** to yield **DADS**. Despite the low yield observed at the Nicholas cyclization stage, which is assumed to be due to the presence of two basic Me<sub>2</sub>N groups capable of deactivating Lewis acid, the synthesis of **DADS** is fast, reliable, simple, and allows for the preparation of a symmetrical fluorescent cycloalkyne ready for further application in just four stages without any additional modification. The synthesized cyclononyne **DADS** is stable and active in SPAAC.

The application of the developed fluorescent cycloalkyne will be demonstrated using click reactions with N<sub>3</sub>-amino acids. This concept can be further utilized for the identification of unnatural azido-amino acids, thereby providing a bioorthogonal alternative to the dansyl method for identifying classical proteinogenic amino acids.

## References

- [1] *J. Am. Chem. Soc.* **2004**, *126*, 15046
- [2] *Angew. Chem. Int. Ed.* **2010**, *49*, 9422
- [3] *Angew. Chem. Int. Ed.* **2015**, *54*, 1190

## Acknowledgements

This work was supported by the Russian Science Foundation (project No 24-23-00377).

# SYNTHESIS OF BIOLOGICALLY ACTIVE NITROGENOUS HETEROCYCLES BASED ON A METALL-CATALYZED COUPLING OF ISOCYANIDES AND GUANIDINES

*Gavrilov G.A.*<sup>1</sup>, *Nguyen T. K.*<sup>1</sup>, *Katkova S.A.*<sup>1</sup>, *Rostovskii N. V.*<sup>1</sup>, *Kinzhalov M. A.*<sup>1</sup>

<sup>1</sup> St. Petersburg State University, St. Petersburg, Russia

Student

[st092203@student.spbu.ru](mailto:st092203@student.spbu.ru)

The imidazole species is a structural fragment of natural products and biologically active compounds [1]. In particular, the metal-based combination of isocyanides with various organic substrates is one of the actively developing approaches in their synthesis [2]. Although, 4d and 5d metals catalysis has dominated metal-catalyzed isocyanide insertion reactions for years, there has been a recent surge in 3d metal catalysis [3]. However, the use of 3d metals is more economical and sustainable. In addition, the Ni-based catalytic system involves reactions Ni<sup>I</sup>/Ni<sup>III</sup> and Ni<sup>0</sup>/Ni<sup>I</sup>/Ni<sup>II</sup> reactions behind M<sup>0</sup>/M<sup>II</sup> and M<sup>II</sup>/M<sup>IV</sup> transformations, respectively. This reactivity is not observed in palladium catalysis, and opens up new, mechanistically distinct reaction pathways for the synthesis of heterocyclic scaffolds

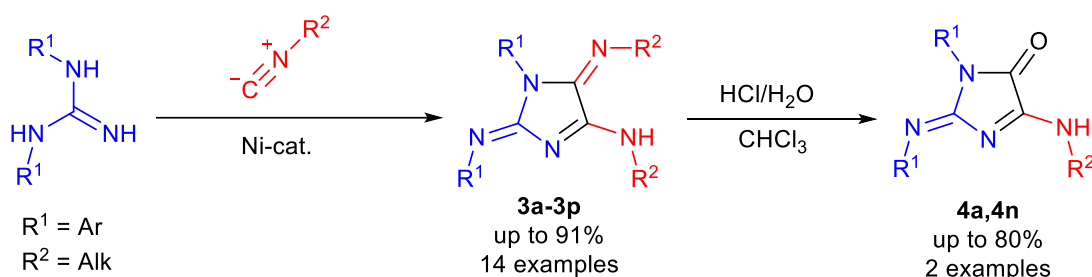

**Scheme 1.** Synthesis of tetrasubstituted imidazole derivatives

In this work we investigated a double oxidative coupling of isocyanides with guanidines, which is promoted by nickel(II) compounds. As result, a series of imidazoles **3a-3p** were obtained with good yields under heating or visible light irradiations. The reaction proceeds in good yield, under thermal or visible light activation. In addition, the hydrolysis possibility of imidazoles **3a**, **3n** were demonstrated. All synthesized compounds are characterized by high-resolution mass spectrometry (ESI<sup>+</sup>-HRMS), <sup>1</sup>H, and <sup>13</sup>C{<sup>1</sup>H} NMR spectroscopy. The solid-state structures of **3a**, **3c-3f**, **3i**, **3j**, **4a** were studied by a single-crystal X-ray diffraction. The testing of synthesized compounds against pathogens of the ESKAPE panel showed a high activity with MIC up to 0.38 μg/mL.

## References

- [1] *BMC Chem.* **2021**, *15*, 12
- [2] *Angew. Chem., Int. Ed.* **2013**, *52*, 7084
- [3] *Chinese J. Org. Chem.* **2022**, *42*, 2659

## Acknowledgements

This work was supported by the Russian Science Foundation (project No 24-23-00367). Measurements were performed at Center for Magnetic Resonance, Center for X-ray Diffraction Studies, Center for Chemical Analysis and Materials Research, and Computing Centre (all belong to St Petersburg University).

## GREEN, ONE-POT SYNTHESIS OF PYRAZOLE DERIVATIVES BASED ON CHALCONES

Karapetyan A.V.<sup>1</sup>, Gharibyan Y.A.<sup>1,2</sup>, Gharibyan T.K.<sup>1</sup>, Yengoyan A.P.<sup>1,2</sup>, Ghazaryan E.A.<sup>1</sup>

<sup>1</sup> Armenian National Agrarian University, Yerevan, Armenia

<sup>2</sup> Russian-Armenian University, Yerevan, Armenia

3<sup>d</sup> year Ph.D. student

[yan.gharibyan@gmail.com](mailto:yan.gharibyan@gmail.com)

Substituted chalcones continue to captivate researchers' attention due to their promising potential in the development of novel pharmaceuticals and pesticides [1-3]. At the present moment, various methods for the synthesis of chalcones have been described. Furthermore, on the basis of the obtained chalcones, syntheses of various heterocyclic compounds have been described. In addition to conventional techniques, published works include synthesis methodologies involving ultrasonic [4,5] or microwave [6-8] irradiation. Among chalcones and their derivatives, compounds have been found that have anti-inflammatory, anticancer, antioxidant, antimicrobial, antiviral, anti-diabetic, anticonvulsant, antileishmania, antimalarial, analgesic and anti-neurodegenerative activities.

In recent years, the one-pot synthesis method has been attracting more attention [9-11]. This method improves the efficiency of the synthesis. The reaction occurs in a single vessel, where all reagents are added consecutively without intermediate treatment. Elimination of the processing and cleaning process saves time and chemical resources.

The purpose of this study was the one-pot synthesis of pyrazole derivatives using microwave irradiation and traditional methods, and further comparison of these methods. Synthesis consists of two stages. The first stage is getting chalcone by Claisen–Schmidt's condensation between benzaldehydes and acetophenones. In this way, 13 chalcones were produced. The second one is pyrazole derivative synthesis from previously obtained chalcones and added phenylhydrazine (Scheme 1).

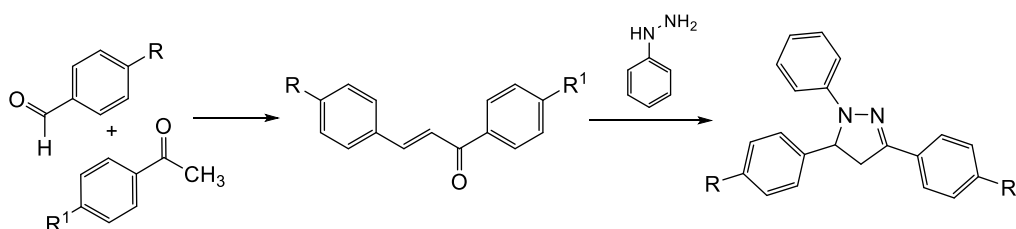

**Scheme 1.** One-pot synthesis of pyrazole derivatives based on chalcones.

The method of one-pot synthesis with microwave irradiation allows for a decrease in reaction time by 7 times and an increase in reaction yield compared to conventional methods.

### References

- [1] *Omega* **2022**, 7, 27769–27786
- [2] *Front. Chem.* **2022**, 10, 988376
- [3] *Molecules*, **2023**, 28(10), 4009
- [4] *ChemistrySelect*, **2019**, 4, 9807–9810
- [5] *Food Chem. Toxicol.* **2021**, 148, 111969
- [6] *Synth. (Stuttg)* **2020**, 52, 1779–1794
- [7] *Curr. Microw. Chem.* **2017**, 4, 146–151
- [8] *J. Heterocycl. Chem.* **2018**, 55, 2075–2081
- [9] *ChemistrySelect*, **2017**, 2, 9701–9705
- [10] *Biomol. Chem.*, **2017**, 15, 6702–6705
- [11] *J. Heterocycl. Chem.*, **2020**, 57, 1201–1210
- [12] *Synlett*, **2022**, 33, 555–558

### Acknowledgements

This work was supported by the State Committee for Science of the Ministry of Education and Science of the Republic of Armenia within the framework of scientific project No. 21T-1D165.

# SYNTHESIS OF 1,3-DICARBONYL AZEPINES VIA PHOTOINITIATED REACTIONS OF ARYL AZIDES WITH CARBON-BASED NUCLEOPHILES

*Giricheva M.A., Vorobiev I.G., Budruev A.V.*

Lobachevsky State University, Nizhny Novgorod, Russia

PhD student

[m.a.giricheva@gmail.com](mailto:m.a.giricheva@gmail.com)

Nucleophilic addition reactions involving 1,3-dicarbonyl compounds provide a practical approach to forming carbon-carbon bonds. These transformations have a broad range of applications, including well-known processes such as the Michael reaction, Knoevenagel condensation, Hantzsch pyridine synthesis, and the Biginelli reaction, among others. The products of reactions often serve as precursors for further molecular modifications and are widely used in the synthesis of heterocyclic compounds and pharmaceuticals.

The photoinitiated decomposition of aryl azides **1** leads to a sequential rearrangement of singlet nitrenes **A** into benzazirines **B** and then into cyclic ketenimines **C**. In the presence of nucleophiles **2**, the electron-deficient carbon atom of the ketenimine fragment of intermediate **C** undergoes a nucleophilic attack, resulting in the formation of a 2-substituted azepine **3** [1-2]. Based on this, and taking into account the practical significance of dicarbonyls, we have developed a synthesis protocol for obtaining various 1,3-dicarbonyl-substituted azepines through the nucleophilic addition of the active methylene fragment of the dicarbonyl compound to the *sp*-hybridized carbon of 1,2-didehydroazepine **C** (Scheme 1).

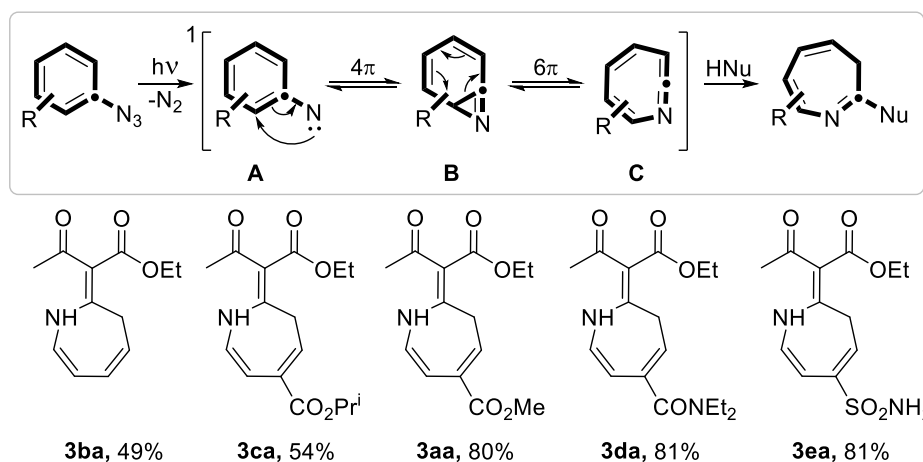

**Scheme 1.** Photoinitiated Transformation of Aryl Azides and Scope of Application of the Substrate for the Synthesis of 2-(1,3-Dicarbonyl)-Substituted Azepines.

In order to select optimal reaction conditions and study the factors influencing the efficiency of the formation of the target product, screening of solvents and bases was carried out in order to select optimal reaction conditions. The optimal conditions for the synthesis of (*E*)-7-(1-ethoxy-1,3-dioxobutan-2-ylidene)-6,7-dihydro-1H-azepine-4-carboxylate **3aa** were achieved using a water-ethanol mixture of methyl 4-azidobenzoate **1a** under mildly alkaline conditions, with a two molar excess of ethyl acetoacetate **2a** and sodium carbonate in a 1:1 ratio. The optimal irradiation period was found to be 2 hours, which corresponds to the complete decomposition of azide at its concentration of 8 mM. The capabilities and limitations of this methodology was investigated using ethyl acetoacetate **2a** as a substrate. The yields of azepines **3** ranged from high to low. Data analysis revealed that enhancing the electron-accepting properties of the substituent leads to an increase in azepine yields, a characteristic of Michael addition reactions. In this context, electron-accepting substituents amplified the electrophilicity of the *sp*-hybridized carbon in 1,2-didehydroazepine **C**, rendering it more susceptible to nucleophilic attack.

In conclusion, a methodology for the photoinitiated one-pot synthesis of 2-(1,3-dicarbonyl)-substituted azepines by the reaction of aryl azides with both electron-donating and electron-withdrawing groups and 1,3-dicarbonyl compounds have been developed.

## References

- [1] *Angew. Chem., Int. Ed.* **2005**, *44*, 5188  
 [2] *Chem. Rev.* **1988**, *88*, 351

## SYNTHESIS OF 4-(TRIFLUOROMETHYL)THIOCOUMARINS

Golubev A.S.<sup>1</sup>, Golubev I.M.<sup>1,2</sup>, Ostapchuk P.N.<sup>3</sup>, Strelkova T.V.<sup>1</sup>, Suponitsky K.Yu.<sup>1</sup>, Chkanikov N.D.<sup>1</sup>

<sup>1</sup> A.N.Nesmeyanov Institute of Organoelement Compounds of Russian Academy of Sciences (INEOS RAS), Moscow, Russia

<sup>2</sup> D.I. Mendeleev University of Chemical Technology of Russia, Moscow, Russia

<sup>3</sup> N. D. Zelinsky Institute of Organic Chemistry Russian Academy of Sciences, Moscow, Russia

Golubev I.M. (undergraduate student of D.I. Mendeleev University, Moscow, Russia)

[igorgo2002@mail.ru](mailto:igorgo2002@mail.ru)

Thiocoumarins (2*H*-thiochromen-2-ones) are a structural analogue of coumarins in which the oxygen atom of the pyran core is replaced by a sulfur atom [1]. In general, thiocoumarins have received significantly less attention from the research community compared to coumarins, which is not least due to the complexity of the synthesis of thiocoumarins. Recently, there has been a significant increase in the interest of synthetic chemists and pharmacologists in thiocoumarins [2,3].

4-(Trifluoromethyl)thiocoumarins (4-trifluoromethyl-2*H*-thiochromen-2-ones) are not described in the literature. At the same time, 4-trifluoromethyl-containing coumarins, in particular 7-amino- and 7-hydroxy-4-(trifluoromethyl)coumarins, as well as their derivatives, have found wide application in practice (fluorescent samples in various biological, analytical and photochemical studies) and in medical research.

We have developed a convenient method for the synthesis of 4-(trifluoromethyl)thiocoumarins starting from 1-(2-(*tert*-butylthio)phenyl)-2,2,2-trifluoroethanones. The construction of the thiopyranone core of 4-(trifluoromethyl)thiocoumarins was carried out by the reaction of *S*-acylation of compounds with bromoacetyl bromide, followed by the formation of a phosphonium salt by treatment with triphenylphosphine and the subsequent intramolecular Wittig reaction. 3-Substituted 4-(trifluoromethyl)thiocoumarins were synthesized by the *S*-acylation reaction of 2-*tert*-butylthio-trifluoroacetophenones with acetyl chlorides having an active methylene group, followed by intramolecular Knoevenagel condensation (Scheme 1).

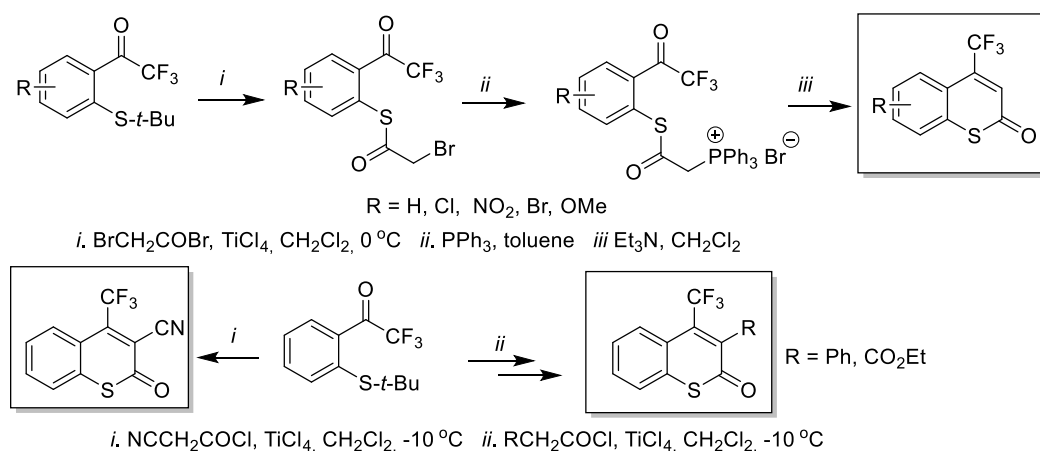

**Scheme 1.** Synthesis of 4-(trifluoromethyl)thiocoumarins.

The scope and limitations of the developed synthetic scheme, as well as the physicochemical properties of the newly synthesized 4-(trifluoromethyl)thiocoumarins are discussed.

### References

- [1] *Adv. Heterocycl. Chem.* **1980**, 26, 115-133  
 [2] *Curr. Org. Chem.* **2020**, 24(16), 1793-1814  
 [3] *Molecules* **2022**, 27(15), 4901

### Acknowledgements

The work was carried out within the framework of an internal grant from INEOS RAS GZ 2024-03/07.



NEW ALLOSTERIC AMPA RECEPTOR MODULATORS  
BASED ON TRICYCLIC BISPIDINE DERIVATIVES WITH INDANE MOIETY

*Golubeva E.A.*<sup>1</sup>, *Lavrov M.I.*<sup>1</sup>, *Zamoyski V.L.*<sup>2</sup>, *Grigoriev V.V.*<sup>1,2</sup>, *Palyulin V.A.*<sup>1</sup>

<sup>1</sup> Lomonosov Moscow State University, Department of Chemistry, Moscow, Russia

<sup>2</sup> Institute of Physiologically Active Compounds, Federal Research Center of Problems of Chemical Physics and Medicinal Chemistry, Russian Academy of Sciences, Chernogolovka, Moscow Region, Russia

PhD student

[elena.a.golubeva@gmail.com](mailto:elena.a.golubeva@gmail.com)

One of the key areas of modern medicinal chemistry is devoted to the development of new drugs for the treatment of psychoneurological and neurodegenerative diseases. A very important biological target of such drugs is the glutamatergic system. Among the substances acting on the glutamatergic system, the most interesting are allosteric modulators of the AMPA receptor. The basis of the therapeutic potential of these compounds is their ability to influence synaptic plasticity, which ensures the formation of neuronal memory, and to increase significantly the expression of neurotrophic factors that stimulate the regeneration of nervous tissue, as well as their antidepressant effect. Positive modulators have cognitive-stimulating and neuroprotective effects; negative modulators are known for their antiepileptic activity [1].

It was previously shown that tricyclic derivatives of bispidine exhibit high activity towards the AMPA receptor [2]. In this regard, the synthesis and study of such compounds are very relevant.

A virtual focused library of potential allosteric modulators of the AMPA receptor based on a tricyclic scaffold of bispidine was developed using molecular modeling methods. In this work, a series of new tricyclic bispidine derivatives with indane moiety was obtained through a 9-step divergent synthesis.

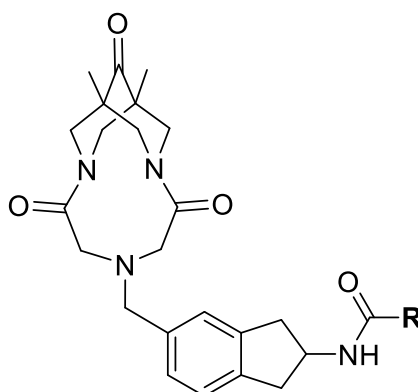

**Figure 1.** General structure of tricyclic bispidine derivatives with indane moiety.

The resulting compounds have demonstrated high modulatory activity, positive or negative, towards the AMPA receptor over a wide range of nanomolar and subnanomolar concentrations in *in vitro* studies using the electrophysiological *patch clamp* method. The results for one of the compounds with positive modulatory activity are presented below [3].

**Table 1.** The results of electrophysiological *in vitro* studies for one of the compounds.

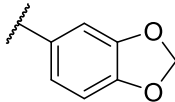
 R =	Concentration, M	10 <sup>-12</sup>	10 <sup>-11</sup>	10 <sup>-10</sup>	10 <sup>-9</sup>	10 <sup>-8</sup>	10 <sup>-7</sup>	10 <sup>-6</sup>
	Current amplitude, % of control	110±3	131±7	180±11	131±8	111±9	105±6	131±8

### References

- [1] *Biomolecules*, **2023**, *13*, 56  
 [2] *Mendeleev Commun.*, **2022**, *32*, 360  
 [3] *Mendeleev Commun.*, **2023**, *33*, 70–72

### Acknowledgements

This work was supported by the Russian Science Foundation (project No 22-15-00041).

## DESIGN, SYNTHESIS AND ANTI-TUMOR ACTIVITY OF AN ORIGINAL MATRIX METALLOPROTEINASES-2 AND -9 INHIBITOR

*Grigorkevich O.S.<sup>1</sup>, Zhurikov R.V.<sup>1</sup>, Kovalenko L.P.<sup>1</sup>, Durnev A.D.<sup>1</sup>, Gudasheva T.A.<sup>1</sup>, Dorofeev V.L.<sup>1</sup>*

<sup>1</sup> Federal research center for innovator and emerging biomedical and pharmaceutical technologies,  
Moscow, Russia  
Researcher  
[grigorkevich\\_os@academpharm.ru](mailto:grigorkevich_os@academpharm.ru)

Matrix metalloproteinases 2 and 9 (MMP-2 and MMP-9) (gelatinases A and B, respectively) belong to the family of zinc-dependent endopeptidases capable to hydrolyze the main protein components of the extracellular matrix (collagen, laminin, fibronectin, etc.) [1]. In the human body MMP-2/-9 can have a destructive effect on the extracellular matrix, during inflammation and oxidative stress [2], which leads to the development of cancer [1]. Gelatinases are involved in the mechanism of tumor invasion and angiogenesis during tumor growth. To date, none of the MMP-2/-9 inhibitors are used in clinical practice for the treatment of cancer. In this regard, it seems relevant to create and study the antitumor activity of new gelatinase inhibitors.

Taking into account the structural requirements for MMP-2 and MMP-9 inhibitors [3], the compound 1-({4-[(2,4-dichlorobenzoyl)amino]phenyl)sulfonyl-(2S,4R)-4-hydroxypyrrolidine-2-carboxylic acid (GGM-27) was designed. By using the molecular docking method by dint of 3D-structures of the proteins MMP-2 (PDB ID: 1HOV) and MMP-9 (PDB ID: 5CUH) the potential of GGM-27 as an inhibitor of MMP-2 (docking score -7.161) and MMP-9 (docking score -6.788) was confirmed, based on the docking score values.

The compound GGM-27 was synthesized in 3 stages using classical organic synthesis in solution with a total yield of 40%.

Using the fluorogenic substrate Mca-Lys-Pro-Leu-Gly-Leu-Dpa-Ala-Arg-NH<sub>2</sub> and recombinant human MMP-2 and MMP-9, GGM-27 showed inhibitory activity towards MMP-2 (K<sub>i</sub> 9.4\*10<sup>-5</sup> M) and MMP-9 (K<sub>i</sub> 9.0\*10<sup>-4</sup> M).

To study the antitumor activity of the compound GGM-27, the Ca755 breast adenocarcinoma model was chosen.

As a result of the experiment in active control animals, the average tumor volume on the 9<sup>th</sup>, 15<sup>th</sup> and 21<sup>st</sup> days Ca755 adenocarcinoma's growth was 302.9±79.1 mm<sup>3</sup>, 5353.8±930.9 mm<sup>3</sup>, 10908.7±1307.8 mm<sup>3</sup> respectively. In animals receiving GGM-27 in the dose of 1 mg/kg, a significant decrease in the average tumor volume was determined compared with the control (p<0.05) on the 9<sup>th</sup> and 21<sup>st</sup> days of tumor growth: 90.8±50.4 mm<sup>3</sup> and 4036.9±710.2 mm<sup>3</sup>, respectively. In the group of animals receiving GGM-27 in the dose of 10 mg/kg, a significant decrease in the average tumor volume was also determined compared to the control (p<0.05) on the 9<sup>th</sup> and 21<sup>st</sup> days of the growth of Ca755 adenocarcinoma 84.5±56,34 mm<sup>3</sup> and 4074.1±672.5 mm<sup>3</sup>, respectively. In animals treated with the antitumor drug, doxorubicin, in the dose of 4 mg/kg, a significant decrease in the average tumor volume was determined (p<0.05) compared to the control on the 9<sup>th</sup>, 15<sup>th</sup> and 21<sup>st</sup> days of tumor growth 7.5±6.2 mm<sup>3</sup>, 462.4±122.9 mm<sup>3</sup> and 2951.1±608.4 mm<sup>3</sup>, respectively. The experiment determined significant tumor growth inhibition (TGI) on the 21<sup>st</sup> day of tumor growth, 7 days after the end of drug administration. When administering GGM-27 in the dose of 1 mg/kg, TGI on the 21<sup>st</sup> day of the experiment was 63%; when administering GGM-27 in the dose of 10 mg/kg, TGI actually did not change and amounted to 62%. When doxorubicin was administered on the 2<sup>nd</sup> and 4<sup>th</sup> days of adenocarcinoma's Ca755 growth, TGI on the 21<sup>st</sup> day of tumor growth was 73%.

The increase in average life expectancy when GGM-27 was administered in the dose of 1 mg/kg was 45% (p<0.05), when administered in the dose of 10 mg/kg increasing in average life expectancy was 47% (p<0.05) compared with active control. When the comparison drug doxorubicin was administered, a significant (p<0.05) increasing in average life expectancy was 58% compared to the active control.

The data obtained indicate expressed antitumor activity of the compound GGM-27 in the Ca755 breast adenocarcinoma model when administered for 14 days in the dose of 1 and 10 mg/kg.

### References

- [1] *Int. J. Mol. Sci.* **2020**, 21(24), 9739
- [2] *Biochim. Biophys. Acta.* **2014**, 1840(8), 2571
- [3] *Bioorg. & Med. Chem.* **2007**, 5, 2223

# DBU-PROMOTED CYCLIZATIONS OF CYCLOPENTYL-SUBSTITUED OXAZAPOLYENES TO CYCLOPENTAPYRIDONES AND HYDROXYPYRROLES: EXPERIMENTAL AND DFT STUDY

Grishin A.V.<sup>1</sup>, Filippov I.P.<sup>1</sup>, Zakharov T.N.<sup>1</sup>, Khlebnikov A.F.<sup>1</sup>,  
Novikov M.S.<sup>1</sup>, Rostovskii N.V.<sup>1</sup>

<sup>1</sup> St. Petersburg State University, St. Petersburg, Russia  
Student

[st106272@student.spbu.ru](mailto:st106272@student.spbu.ru)

Chemistry of 2*H*-azirines and diazo compounds is the focus of our research group [1]. It is well-known, that diazo compounds are able to react with 2*H*-azirines under rhodium catalysis to form azapolyenes. These unsaturated compounds can be utilized as building blocks for a wide range of heterocyclic compounds, such as dihydroazetes, pyrroles, azines and their fused analogues [2]. Previously, we have shown, that under basic conditions 1-pyrrolines can be obtained from 4-alkylazabutadienes [3]. It was recently discovered that 1,1-di(alkoxycarbonyl)-4-cyclopentyl-2-azabuta-1,3-dienes **2** react with DBU to form two types of heterocyclic products: 1*H*-cyclopenta[*c*]pyrid-1-ones **4** and 3-hydroxy-1*H*-pyrroles **5** (Scheme 1). These previously unknown transformations proceed through the formation of 1-azapentadienyl anion **3** which undergoes 1,6-shift of alkoxycarbonyl group to the cyclopentyl part followed by 1,6-cyclization to form the cyclopentapyridone (path *a*) and 1,5-cyclization with 1,3-shift of methoxy group followed by dialkyl carbonate elimination to form the hydroxypyrrole (path *b*). The possible reaction pathways of the reactions have been studied by using quantum chemical DFT calculations. Pyridones can be prepared in moderate yields in a one-pot three-step procedure via Rh(II)-catalyzed isomerization of 4-cyclopentylisoxazoles **1** to 2*H*-azirines; the next step is the reaction of 2*H*-azirine with diazomalonic esters; and the final stage is heating of the prepared 2-azabuta-1,3-dienes **2** with DBU.

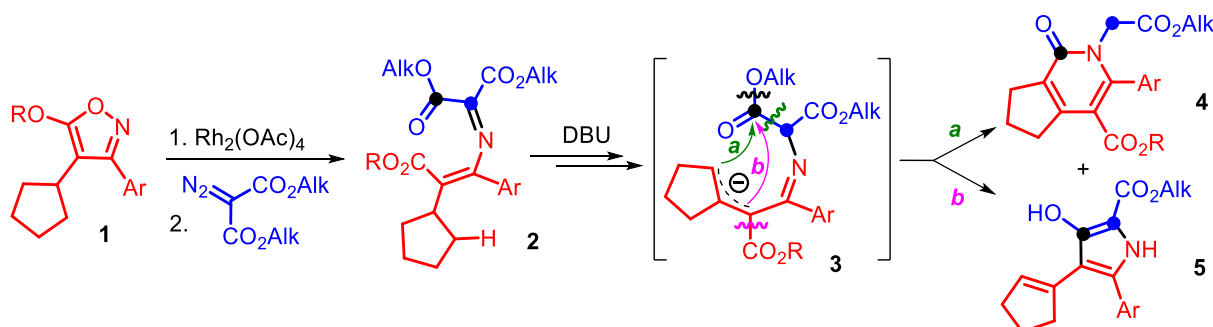

Scheme 1. Experimental results.

## References

- [1] *Tetrahedron*, **2019**, *75*, 2555
- [2] *Organics* **2021**, *2*, 313
- [2] *J. Org. Chem.* **2022**, *87*, 8835

## Acknowledgements

This work was supported by the Russian Science Foundation (grant 22-73-10184).

## ANTAGONISTIC ACTIVITY OF GALLIUM AND ITS COMPOUNDS

Tsagaraev T.V.<sup>1</sup>, Andreeva A.S.<sup>1</sup>, Gromov N.V.<sup>1</sup>

<sup>1</sup> ITMO University, St. Petersburg, Russia

Student

[timur.tsagaraev@mail.ru](mailto:timur.tsagaraev@mail.ru)

Gallium is a chemical element known for its low melting temperature and low toxicity to humans in contrast to mercury. The metal has recently begun to be used in medicine: as an antagonistic agent, to increase osteogenesis, influence blood clotting and as a coating for titanium implants. The effectiveness of gallium as an antibacterial agent arises from its similarity to Fe<sup>3+</sup> in terms of atomic radius, electronic configuration, and charge state, enabling gallium (III) to effectively mimic iron (III). Unlike Fe (III), Ga (III) cannot be reduced under physiological conditions to Ga (II), as reduction of Fe (III) to Fe (II) is a main step in many intracellular processes. In addition, many proteins require Fe (III) as a key cofactor. Thus, any binding of Ga (III) to Fe (III) protein binding sites may disrupt biological processes involving redox interactions. It can be concluded that gallium has the potential to work as an antibacterial agent with a very broad spectrum of activity. Moreover, gallium does not appear to be susceptible to classical resistance mechanisms commonly associated with antibiotics, such as decreased uptake due to restricted permeability of cellular envelope, drug efflux pumps, and detoxifying enzymes such as beta-lactamases [1].

The pure metallic gallium-based dispersion systems (sols, emulsions) have antimicrobial properties at high concentrations (> 2 mg/ml). However, some sources consider Ga cannot demonstrate the full opportunity to be a protection from different microorganisms. The superior antagonistic activity reported in the literature may be related with the presence of trace heavy metals [2]. Thus, to confirm the antimicrobial activity of pure gallium, experiments with gallium with a high degree of purity should be performed. After that, the antagonistic properties of gallium-based composites or alloys can be proved. Besides, compounds with different metals can show the same features for decline concentration of individual substances. Therefore, this work is aimed to reduce concentration of the pure gallium to preserve its effect on microorganisms. The morphology and structure of particles was described using SEM (scanning electron microscopy), EDS (Energy-dispersive X-ray spectroscopy), XRD (X-ray powder diffraction). The viability of different microorganisms was analysed by counting colony forming units, the concentration of microorganisms in the suspension was determined using optical methods.

Consequently, the following results were achieved: the antagonistic effect of pure gallium was confirmed on *E. coli* and other facultatively anaerobic microorganisms, a composite confirmed antimicrobial activity was obtained.

### References

[1] *Curr Opin Pharmacol.* **2013**, *13*(5), 707-16

[2] *ACS Appl. Mater Interfaces* **2024**, *16*(1), 332-341

## EXPERIMENTAL STUDY OF «FLIPPING» METALATION OF 4-DIMETHYLAMINOPYRIDINE

*Gubanova A.N.<sup>1</sup>, Verkhov V.A.<sup>1</sup>, Antonov A.S.<sup>2</sup>*

<sup>1</sup> St. Petersburg State University, St. Petersburg, Russia

<sup>2</sup> University of Regensburg, Regensburg, Germany

Student

[st097979@student.spbu.ru](mailto:st097979@student.spbu.ru)

For a long time, it was believed that the metalation of 4-dimethylaminopyridine (DMAP) is possible only in the position 2(6), due to the conjugation of the NMe<sub>2</sub> group with the ring and as a result, the absence of the DOM-effect. It was only in 2006 that DMAP metalation was achieved in the position 3(5) using sterically hindered Caubère's salt [1].

In the early work of our laboratory, it was shown that the introduction of bulky groups leads to a change in the direction of metalation reactions. Thus, the main idea of this work is to study the effect of various substituents on the direction of metalation.

In our work, we have investigated the interaction of the DMAP molecule with weakly nucleophilic organometallic reagents such as lithium diisopropylamide (LDA) and lithium tetramethylpiperidine (LTMP). Usually, these reagents do not react with DMAP. For this reason, the nitrogen atom of the aza group was quaternized by various groups, such as BF<sub>3</sub> and Alk<sub>3</sub>Si, to increase the acidity of the CH-bonds. It was found that an increase in the volume of the substituent leads to a change direction of the metalation reaction from positions 2(6) to positions 3(5) (scheme 1).

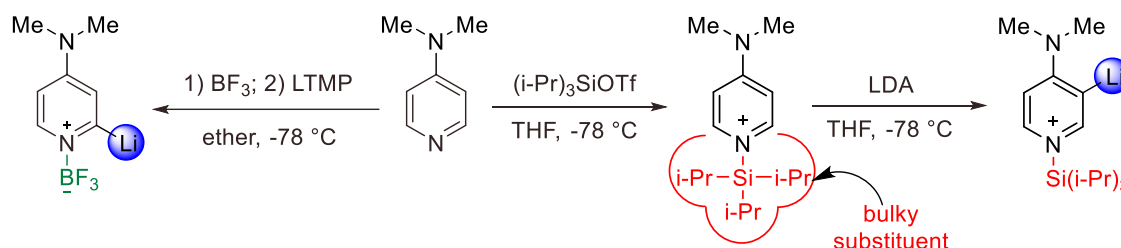

**Scheme 1.** Interaction of DMAP and its 1-derivatives with weakly nucleophilic organometallic reagents.

In addition, the interaction of strong base organolithium reagents such as tert-BuLi with DMAP·Me<sub>3</sub>Si leads to an increase in conversion. Moreover, as theoretical calculations have shown, the organometallic reagent itself coordinates to the aza group and blocks positions 2(6), thus it leads to metalation at position 3(5). This made it possible to obtain a set of different products with high yields (scheme 2).

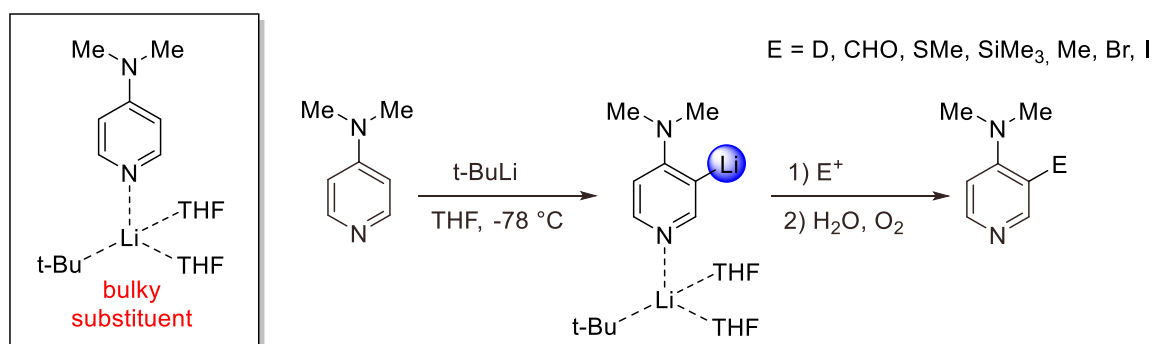

**Scheme 2.** Interaction of DMAP with strong nucleophilic organometallic reagents.

### References

[1] *Chem. Commun.* **2006**, 2673

### Acknowledgements

This work was supported by the Russian Science Foundation (project No 21-73-10040).

# SYNTHETIC STUDIES TOWARDS HASUBANAN ALKALOIDS. ESTABLISHMENT OF TANDEM SIGMATROPIC REARRANGEMENT, RING-CONTRACTION AND DEAROMATISATION METHODOLOGIES

*Ikonnikova V.A.<sup>1</sup>, Mikhaylov A.A.<sup>1</sup>*

<sup>1</sup> Shemyakin–Ovchinnikov Institute of bioorganic chemistry RAS, Moscow, Russia  
PhD Student  
[viktoria.a.ikonnikova@gmail.com](mailto:viktoria.a.ikonnikova@gmail.com)

Total synthesis of natural products can serve as a great source of inspiration for the development of novel synthetic transformations. Hasubanan alkaloids have recently become common target in total synthesis [1]. Their unique benzannulated aza-[4.4.3]-propellane core and yet unclear biological properties have attracted ours and many other research groups for the development of increasingly new and original approaches.

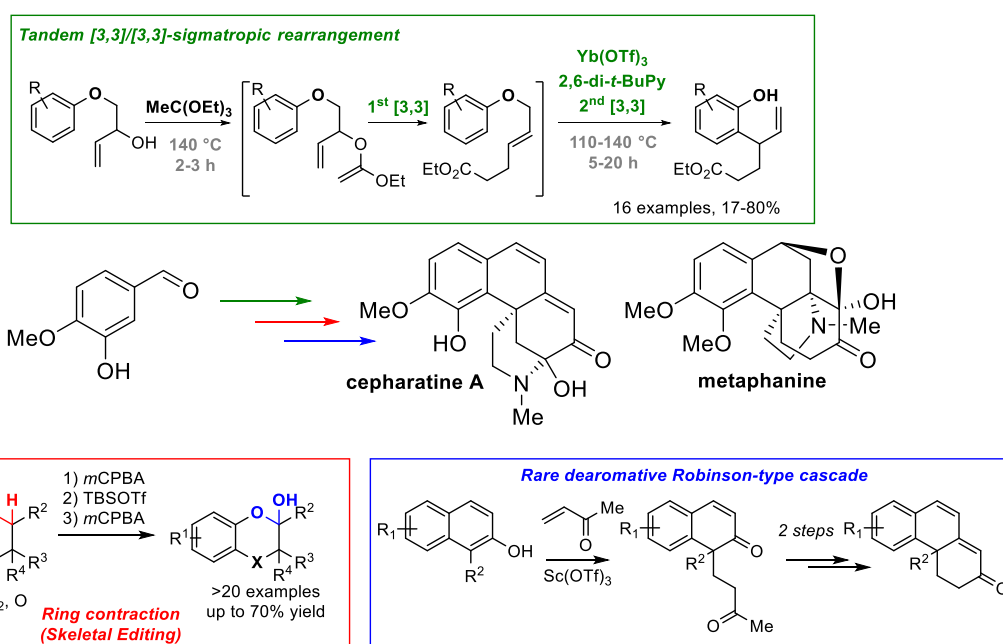

**Scheme 1.** Three novel synthetic transformations towards total synthesis of hasubanan alkaloids.

We have developed a series of three novel synthetic transformations on our way towards total synthesis of hasubanan alkaloids. They are: the tandem [3,3]/[3,3] Johnson-Claisen/Claisen rearrangement promoted by a unique catalytic system [2] (**Scheme 1**, in green); unexpected ring-contractive oxidation of seven-membered lactones under Rubottom conditions (**Scheme 1**, in red) and rare dearomative Robinson-type cascade of 2-naphthols with methyl vinyl ketone (**Scheme 1**, in blue).

A major attention would be paid to lactone ring contraction transformation, which could be regarded as skeletal editing of 1-tetralones towards 2-chromanols. Its high efficiency and tolerance to multiple functional groups has been demonstrated on more than 20 examples, including natural and drug molecules.

Our latest achievements in the field of total synthesis of hasubanan alkaloids will be presented at the conference.

## References

- [1] *Eur. J. Org. Chem.* **2022**, 31, e202200675  
[2] *J. Org. Chem.* **2023**, 88(14), 9737-9749

## Acknowledgements

This work was supported by the Russian Science Foundation (project No 21-73-00165).

# ORGANOCATALYTIC ACTIVATION AND SUBSTITUTION IN ELECTRON-DEFICIENT VINYL HALIDES

Ilyushchenko M.K.<sup>1</sup>, Salikov R.F.<sup>1</sup>, Tomilov Yu. V.<sup>1</sup>

<sup>1</sup> N. D. Zelinsky Institute of Organic Chemistry Russian Academy of Sciences  
Student

[motissyat@gmail.com](mailto:motissyat@gmail.com)

Organocatalytic activation of electron-deficient systems by a number of Lewis bases is currently successfully used to carry out transformations of various types (Scheme 1A). Yet, in the context of the synthesis of  $\beta$ -substituted Michael acceptors this approach is implemented only for the most active olefins, namely allenes and alkynes, which diminishes its synthetic applicability and utility (Scheme 1B). This work presents the possibilities of nucleophilic catalysis as applied to addition-elimination reactions in readily available electrophilic vinyl halides.

The "gold standard" of nucleophilic catalysts, DMAP, allows couplings of sterically hindered vinyl chlorides and weakly acidic nucleophiles in good yields (Scheme 1C). A total of 16 types of nucleophiles were tested; in most cases (oxime, carbamate, NHPI and sulfonamides as nucleophiles) couplings unknown in the non-catalytic version were successfully performed. Organocatalysis allows use of non-polar solvents and weakly basic conditions, which suppresses unwanted side processes and increases the efficiency of reactions.

## A - nucleophilic organocatalysts

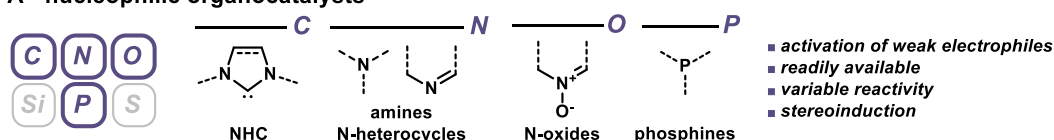

## B - electrophile activation

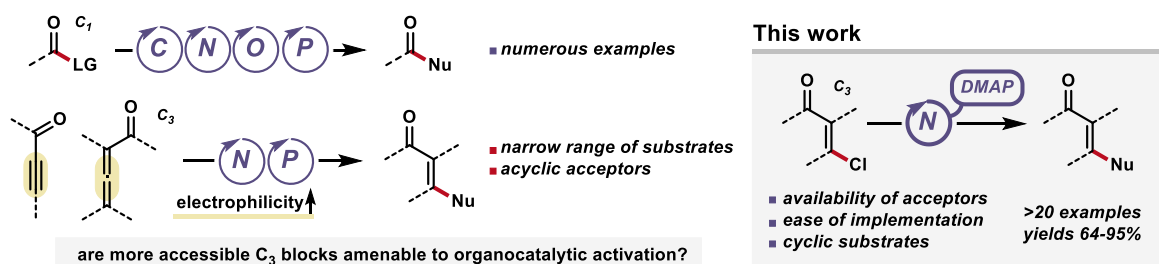

## C - activation and substitution - results

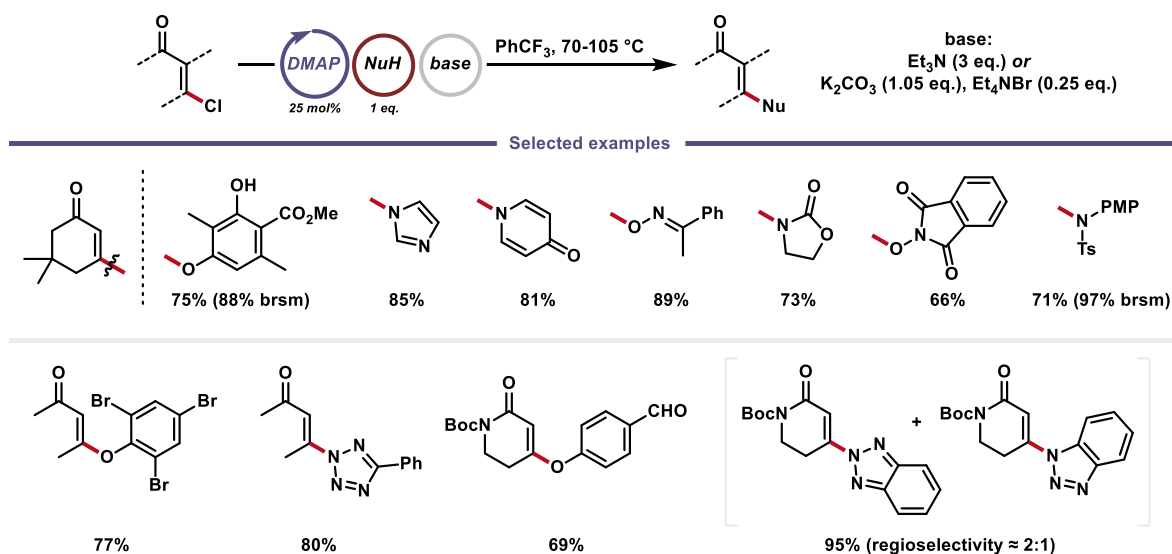

**Scheme 1.** Nucleophilic catalysis in nucleophilic addition-elimination reactions.

## Acknowledgements

This work was supported by the Russian Science Foundation (project No 23-73-10181).

# SYNTHESIS OF BIOLOGICALLY ACTIVE DERIVATIVES OF *N*-ALKYL-10-CHLORO-1,2,3,4-TETRAHYDROBENZO[*b*][1,6]NAPHTHYRIDINES

*Iurina E.S.*<sup>1</sup>, *Raesi G.R.*<sup>1</sup>, *Kulikova L.N.*<sup>1</sup>

<sup>1</sup> Peoples' Friendship University of Russia named after Patrice Lumumba, Moscow, Russia

Student, 4th year graduate

[teri.22@mail.ru](mailto:teri.22@mail.ru)

Benzo[*b*][1,6]naphthyridines constitute a family of heterocyclic compounds that have shown a wide range of biological activities. Among them, the derivatives of *N*-alkyl-10-chloro-1,2,3,4-tetrahydrobenzo[*b*][1,6]naphthyridines attract particular attention in recent years, due to their ability to inhibit MAO-B *in vitro* [1]. Thus, this inhibitory activity suggests their potential efficacy in combating Parkinson's disease and other neurodegenerative disorders.

To expand the library of benzo[*b*][1,6]naphthyridine derivatives, nucleophilic substitution and cross-coupling reactions (Scheme 1) have been carried out. The derivatives 4-5 have been further studied in the reactions with electron-deficient alkynes.

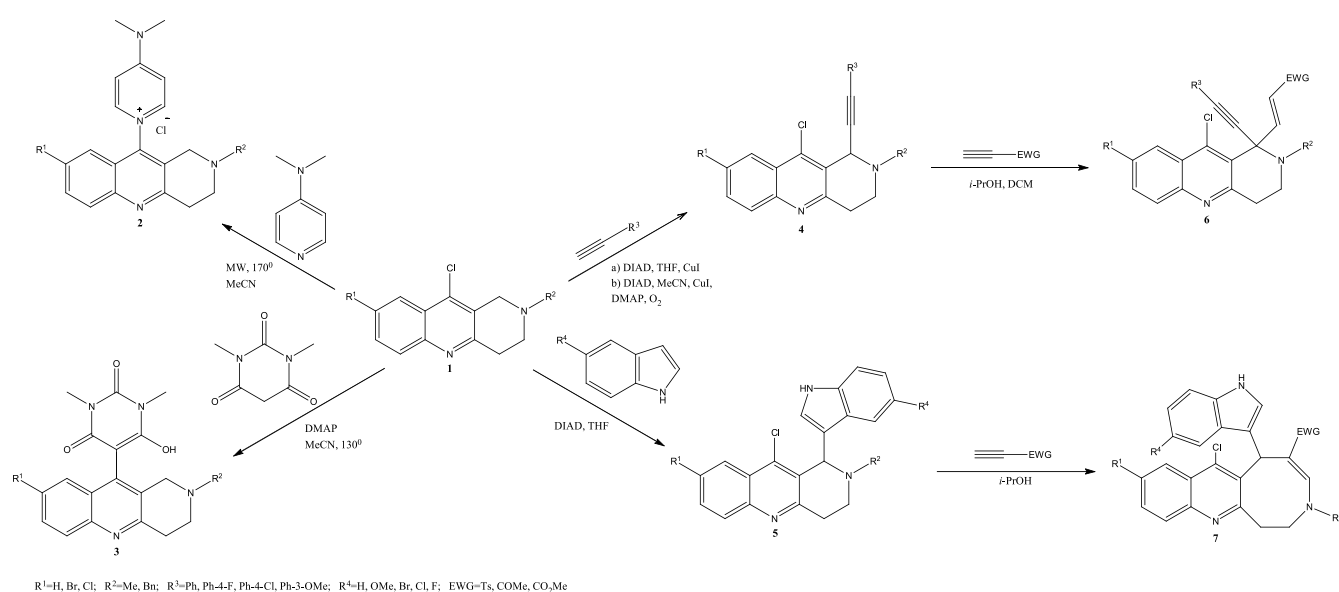

**Scheme 1.** Synthetically useful reactions for modification of tetrahydrobenzo[*b*][1,6]naphthyridines.

## References

[1] *Molecules* **2023**, *28*, 1662



# APPLICATION OF C<sub>3</sub>N<sub>4</sub>@AEROGEL COMPOSITES FOR PHOTOCATALYTIC OXIDATION IN SC-CO<sub>2</sub> MEDIUM

Ivanova E.A.<sup>1,2</sup>, Merkulov V.G.<sup>1,2</sup>, Zharkov M.N.<sup>1</sup>

<sup>1</sup> N.D. Zelinsky Institute of Organic Chemistry, RAS, Moscow Russia

<sup>2</sup> D.I. Mendeleev University of Chemical Technology, Moscow, Russia

Graduate student, BScE

[elizaveta.an.ivanova@gmail.com](mailto:elizaveta.an.ivanova@gmail.com)

A graphite-like carbon nitride (g-C<sub>3</sub>N<sub>4</sub>) emerged in recent years as a promising metal-free semiconductor catalyst for heterogeneous photoreactions. The g-C<sub>3</sub>N<sub>4</sub> is easily synthesized from readily available and inexpensive precursors, such as thiourea and melamine. Its high thermal and chemical stability, along with its narrow and tunable band gap, make g-C<sub>3</sub>N<sub>4</sub> very attractive for photocatalytic applications [1]. However, heterogeneous catalysis is associated with well-known challenges. For example, catalyst particles tend to agglomerate therefore hindering mass transfer and reducing effectiveness and reproducibility [2].

To address these challenges, we present a novel approach involving incorporation of g-C<sub>3</sub>N<sub>4</sub> in silica aerogel matrix (g-C<sub>3</sub>N<sub>4</sub>@SiO<sub>2</sub>) for oxidation reactions in a supercritical carbon dioxide (sc-CO<sub>2</sub>) medium. Ultra-porous, open-cell structure of the aerogel discloses the catalyst active sites and facilitates mass transfer, which enhances the effectiveness of the composite photocatalytic system. Additionally, it is reported that superoxide radicals could form on the silica gel surface, making the matrix advantageous for oxidation reactions [3]. Sc-CO<sub>2</sub> was chosen as the photooxidation process medium since its application allows to preserve the composite 3D structure, i.e., provides the catalyst's recyclability, which is impossible in organic solvents. Furthermore, sc-CO<sub>2</sub> is beneficial for photooxidations processes: it is a non-flammable, non-toxic, transparent to visible light, green solvent that greatly dissolves molecular oxygen.

The catalytic system was applied to thioanisole (**1a**) oxidation by molecular oxygen. In optimal conditions conversion of **1a** reaches 90% with 80% yield of methyl phenyl sulfoxide (**2a**) (Scheme 1). Under the optimal conditions other sulfides (**1b-1f**) were oxidized with conversion of the substrates up to 100% and yields of the corresponding sulfoxides (**2b-2f**) up to 80%.

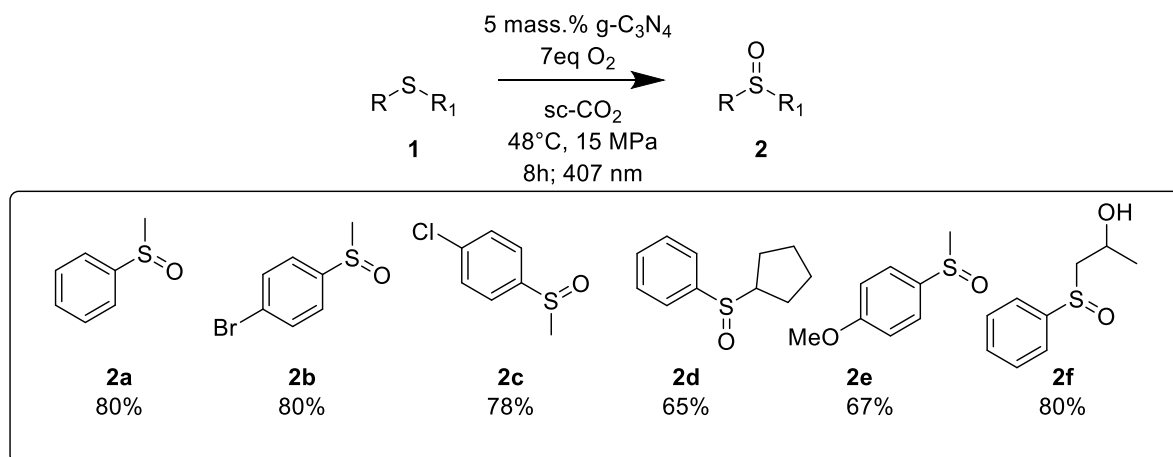

**Scheme 1.** Photooxidation of sulfides and corresponding yields.

The proposed photocatalytic approach paves the path towards the highly efficient, cost-effective, and environmentally benign oxidation processes both in laboratory and industrial scale.

## References

- [1] *Chem. Rev.* **2016**, 116, 12, 7159-7329
- [2] *Small* **2021**, 17, 2104089
- [3] *J. Chem. Eng.* **2019**, 359, 1056-1064P

## Acknowledgements

This work was supported by the Russian Science Foundation (project No 23-73-00071).

# NOVEL CARBAZOLE-FUSED BORON SUBPORPHYRAZINES: SYNTHESIS AND STUDY OF OPTICAL AND PHOTOCHEMICAL PROPERTIES

Ivanova M.M.<sup>1</sup>, Belousov M.S.<sup>1</sup>

<sup>1</sup> Lomonosov Moscow State University, Moscow, Russia  
Student

[mariia.mi.ivanova@chemistry.msu.ru](mailto:mariia.mi.ivanova@chemistry.msu.ru)

Boron subporphyrazines are tripyrrolic macroheterocyclic molecules. Low aggregation in solution and high quantum yields of singlet oxygen and fluorescence make subporphyrazines promising compounds for photodynamic therapy (PDT). The extension of  $\pi$ -system for subporphyrazines results in the shift of the absorption maximum to the range of high transparency of biological tissue (600-900 nm).

Thereby, the purpose of this study was to develop an approach to create new carbazole-annelated subporphyrazine analogues with an extended  $\pi$ -system.

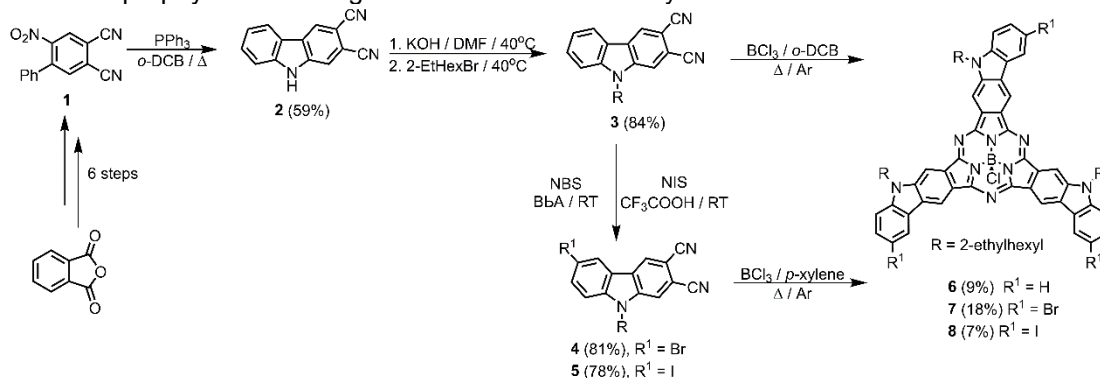

**Scheme 1.** Synthesis of carbazole-fused boron subporphyrazines.

The starting compound 4-phenyl-5-nitrophenalonitrile **1** was synthesized by a six-step approach from commercially available phthalic anhydride. N-(2-ethylhexyl)-substituted carbazole dinitrile **3** was then prepared by a Suzuki cross-coupling reaction followed by Cadogan cyclization and N-alkylation of the resulting carbazole.

At the next step the template condensation reaction of N-substituted carbazole dinitrile **3** was carried out in a boiling *o*-dichlorobenzene in the presence of boron trichloride. However, the target complex **6** was isolated in low yield due to poly- and oligomeric by-products formed by oxidative C-C coupling of carbazole moieties. Protection of the sixth position of the carbazole moiety by selective bromination prevents the formation of oligomeric by-products.

Intense absorption in the range of 638-646 nm was found for novel carbazole-fused subporphyrazines. Moreover, target subporphyrazines show high singlet oxygen (0.27 – 0.42) and fluorescence (0.17 – 0.24) quantum yields.

All target compounds were characterized by FT IR and <sup>1</sup>H NMR spectroscopy, and MALDI TOF spectrometry.

## Acknowledgements

This work was supported by the Russian Science Foundation (grant № 23-73-10076).

## GOLD-CATALYZED CYCLOADDITION OF ENYNES AND CYANAMIDES

*Karagodin B.D., Dubovtsev A. Yu.*

St. Petersburg State University, St. Petersburg, Russia

Student

[st097763@student.spbu.ru](mailto:st097763@student.spbu.ru)

In recent years, gold catalysis has been recognized as a powerful tool for a rapid increase of chemical complexity [1]. In particular, gold-catalyzed transformations of alkynes, as convenient building blocks, are widely used in the syntheses of a plethora of molecular architectures [2]. Here we report on the gold-catalyzed cycloaddition of enynes and cyanamides. Depending on the conditions, this interaction leads to valuable azaheterocyclic systems, namely 2-aminopyridines, 1-aminoisoquinolines, and 2,6-diaminopyrimidines.

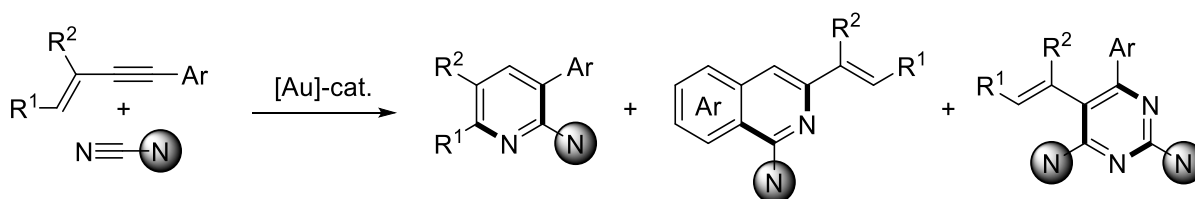

**Scheme 1.** Gold-catalyzed cycloaddition of enynes and cyanamides.

### References

- [1] *Chem. Rev.* **2015**, *115*, 9028
- [2] *Chem. Rev.* **2020**, *121*, 9039

### Acknowledgements

This work was supported by the Russian Science Foundation (project No 23-73-10008).

## USING AN ORGANIC REACTION NETWORK TO PREDICTING SYNTHESIS PATHWAYS

*Karamanova D.A.<sup>1</sup>, Fatykhova A.A.<sup>1</sup>, Gimadiev T.R.<sup>1</sup>*

<sup>1</sup>Intelligent Chemical Robotics Laboratory,  
A.M. Butlerov Institute of Chemistry,  
Kazan Federal University, Kazan, Russia  
Student

[dakaramanova@stud.kpfu.ru](mailto:dakaramanova@stud.kpfu.ru)

Millions of reactions and compounds from patents are linked in a network that is as complex as the World Wide Web. Despite its visual randomness, the chemical network has a well-defined modular architecture.

Organic chemistry analysis using graph theory tools can identify most “central” organic molecules and predict which and how many molecules will be formed in the future. Statistical analysis based on network connectivity is useful for optimizing parallel synthesis, assessing chemical reactivity, and more.

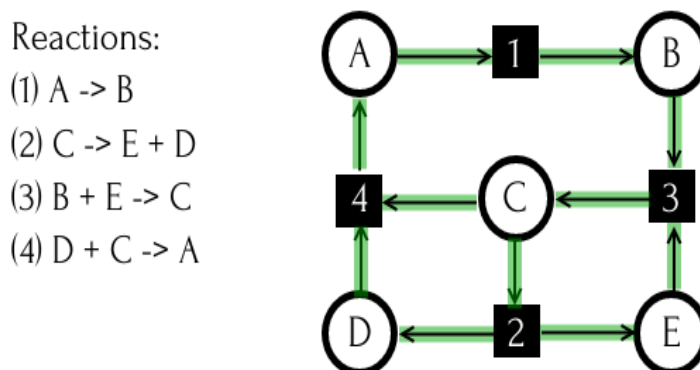

**Scheme 1.** Transforming a set of chemical reactions into a directed graph representation.

We harnessed the power of computer-assisted to map optimal synthesis pathways for a given molecule from commercially available substrates from the ZINC database (1.1 million molecules). This was done by parsing the USPTO patent database (3.6 million reactions), building a synthetic decision tree for the target molecule, and uploading the synthesis map in a convenient format.

The resulting algorithm predicted many previously underestimated pathways for the synthesis of biochemically relevant compounds. A website was also developed for more convenient search of possible synthesis pathways.

### Acknowledgements

This work was funded by the subsidy allocated to Kazan Federal University for the state assignment in the sphere of scientific activities FZSM-2024-0002.

# OXIDATIVE ADDITION OF ALKYL HALIDES AND HALOGENS TO PLATINUM(II) ACYCLIC DIAMINOCARBENE COMPLEXES

*Karcheuskii A.A.<sup>1</sup>, Katkova S.A.<sup>1</sup>*

<sup>1</sup> St. Petersburg State University, St. Petersburg, Russia

Student

[st084093@student.spbu.ru](mailto:st084093@student.spbu.ru)

Oxidative addition of small molecules (halogens and alkyl halides) to the metal center in organometallic complexes is a fundamental reaction in catalysis and new compounds design [1]. Deprotonated acyclic diaminocarbene (ADC)  $d^8$  platinum(II) complexes can easily attach new ligands to the apical positions. In addition, such complexes can be easily obtained by combining isocyanide complexes with N,N-diphenylguanidine [2]. Furthermore, a series of deprotonated platinum(II)-ADC complexes with good antitumor activity against triple-negative breast cancer cells was obtained in our research group [3].

In the present work, the oxidative addition of MeI, EtI, Br<sub>2</sub> and I<sub>2</sub> has been investigated, as platinum(IV) ADC-complexes have never been synthesized by the oxidative addition (**Scheme 1**). Furthermore, the protonation experiments have been carried out to symmetrize the structures and to explore the carbene atoms <sup>13</sup>C chemical shifts, as in the deprotonated forms it was hard to determine which signal was carbene due to overlapping. The oxidative addition was found to shift the <sup>13</sup>C carbene signals 20–30 ppm to the lower field compared to the original platinum(II)-ADC. All compounds were isolated as fine solids and characterized by means of physicochemical analysis.

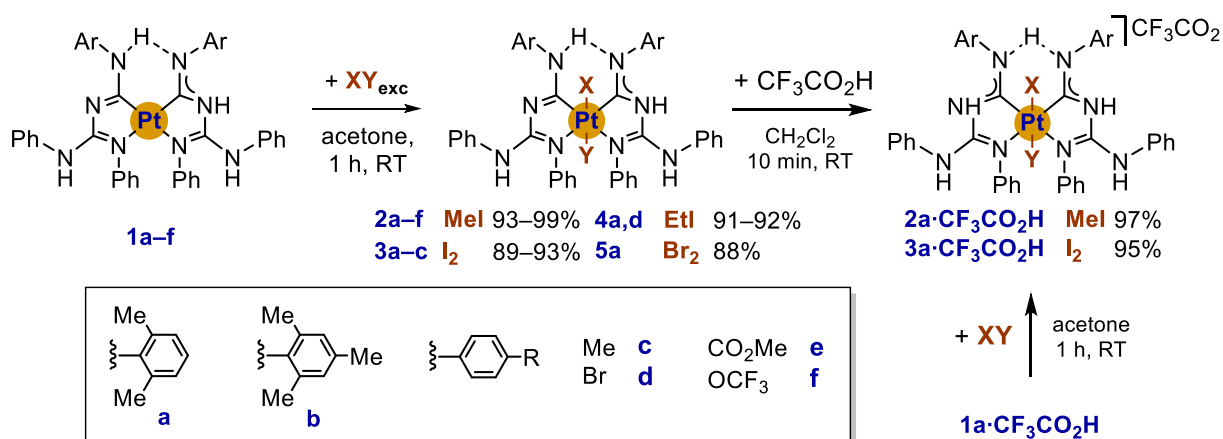

**Scheme 1.** The oxidative addition reactions.

## References

- [1] *Coord. Chem. Rev.* **2014**, 279, 115  
 [2] *Russ. J. Inorg. Chem.* **2022**, 67, 48  
 [3] *Chem Eur. J.* **2024**, e202400101

## Acknowledgements

This work was supported by the Russian Science Foundation (project No 24-23-00367) and performed using the equipment of the Saint Petersburg State University Resource Centers: Center for Magnetic Resonance, Center for X-ray Diffraction Studies, Center for Chemical Analysis and Materials Research, Thermogravimetric and Calorimetric Research Centre.

# MICROWAVE ASSISTED CYCLOADDITION OF BENZONITRILE OXIDES TO 1-IODOBUTA-1,3-DIYNES

*Khachimova D.D.<sup>1</sup>, Efremova M.M.<sup>1</sup>, Govdi A.I.<sup>1</sup>*

<sup>1</sup> St. Petersburg State University, St. Petersburg, Russia  
Student

[st085468@student.spbu.ru](mailto:st085468@student.spbu.ru)

Isoxazole derivatives are of increased interest to researchers due to wide range of their significant biological and photophysical properties. For instance, there are some drugs, which have the isoxazole ring as a key core [1-3].

Nitrile oxides reacts with iodine substituted alkenes to form iodisoxazoles, which can later be modified in cross-coupling reactions such as the Suzuki-Miyaura or Sonogashira reaction. As far as we know cycloaddition of iodo diacetylenes with nitrile oxides have not been described, therefore this study is devoted to the development of a technique for the synthesis of iodisoxazoles from iodo-substituted diacetylenes. The presence of an ethynyl fragment and an iodine atom as substituents in this five-membered heterocycle can provide additional opportunities for modifying the isoxazole structure and creating compounds with potential useful properties. Hence, the possibilities of modifying iodisoxazoles in the Suzuki-Miyaura reaction have also been considered

The purpose of this work is to study the possibilities of iododiacetylenes to enter into reactions of 1,3-dipolar cycloaddition with nitrile oxides and further modifications of the obtained compounds. The synthesis scheme is shown in Scheme 1.

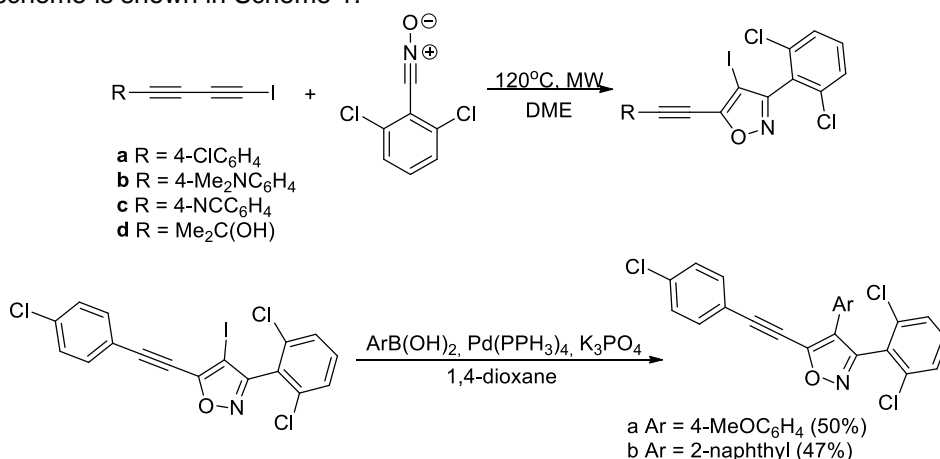

**Scheme 1.** The synthesis scheme.

It was found that iodobutadiynes are capable to react with 2,6-disubstituted aryl nitrile oxides without using catalysts giving 5-ethynyl-4-iodo-1,2,3-isoxazoles with from moderate to good yields. The use of microwave activation made it possible to suggest easily implementable and fast experimental procedure. It was shown that the resulting cycloadducts can be modified in Suzuki-Miyaura cross-coupling reactions.

## References

- [1] *J. Org. Chem.* **2021**, *86*, 5499
- [2] *Chem. Commun.* **2019**, *55*, 12865
- [3] *Bioorg. Med. Chem.* **2018**, *26*, 3065

## Acknowledgements

This work was supported by the Russian Science Foundation (project No 19-73-10077-П).

## PROMISING ATP INHIBITOR MOLECULES FOR THE TREATMENT OF NONALCOHOLIC FATTY LIVER DISEASE

*Khaskanova I.M.<sup>1</sup>, Shelenkova I.E.<sup>1</sup>, Nesterova A.I.<sup>1</sup>, Osroverkhov P.V.<sup>1</sup>, Vadekhina V.V.<sup>2</sup>, Abakumov M.A.<sup>2</sup>*

<sup>1</sup> MIREA – Russian Technological University, Moscow, Russia

<sup>2</sup> Pirogov Russian National Research Medical University, Moscow, Russia

[ihashanova@yandex.ru](mailto:ihashanova@yandex.ru)

Nonalcoholic fatty liver disease (NAFLD) is a leading cause of liver disease worldwide. The global prevalence of NAFLD has been increasing over time, with a recent meta-analysis estimating that 32% of the adult population is afflicted by disease. The prevalence of NAFLD is projected to increase significantly in multiple world regions by 2030 if current trends are left unchecked [1]. To effectively control and treat this metabolic disorder, there are a limited number of drug options specific to NAFLD. If complications occur, such as fibrosis and cirrhosis of the liver, it is possible to provide only palliative care or transplantation. To that end, there is a need to develop a drug for the successful treatment of NAFLD.

Thus, one of the best-characterized mitochondrial uncoupling agents is 2,4 dinitrophenol (DNP) might be an effective and safe approach for the treatment of NAFLD and insulin resistance. This molecule is a protonophore that shuttles protons across the mitochondrial membrane, dissipating the mitochondrial proton gradient and resulting in the conversion of the energy derived from mitochondrial substrate oxidation to heat. DNP was extensively used as a weight loss remedy in the 1930s but taken off the market by the FDA in 1938 due to the occurrence of fatal hyperthermia. Given that the toxicities of DNP are on-target effects related to systemic mitochondrial uncoupling, it is assumed that the safety and therapeutic potential of DNP could be increased by targeting DNP to the liver.

Currently, there is little experimental work aimed at developing a dosage form of DNP for oral and invasive administration. Shulman et al synthesized and studied DNP ethers, considering them as prodrugs. This phenomenon promises to increase the therapeutic window for DNP methyl ester [2]. However, strict pharmacokinetic regulations limit its further use.

In this work, a series of DNP derivatives with increased lipophilicity were designed and synthesized to reduce toxicity and target delivery to the liver. The activity of the obtained substances was confirmed during in vitro tests.

### References

[1] *Clin. Mol. Hepatol.* **2023**, 29, 32

[2] *Mol. Metab.* **2021**, 46, 101178

# MODIFICATION OF ACYCLIC ENEDIYNES AND STUDY OF THEIR BIOLOGICAL ACTIVITY

*Khmelevskaya E.A.<sup>1</sup>, Danilkina N.A.<sup>1</sup>, Aleksanyan N.N.<sup>1</sup>, Silonov S.A.<sup>1</sup>, Balova I.A.<sup>1</sup>*

<sup>1</sup> St. Petersburg State University, St. Petersburg, Russia

PhD student

[st099057@student.spbu.ru](mailto:st099057@student.spbu.ru)

Acyclic enediynes are antitumour agents containing (Z)-3-en-1,5-diyne system. According to the previous studies, these compounds exhibit antitumour activity by inhibiting the expression of cyclin A and Cdc25C proteins; in addition, acyclic enediynes can induce apoptosis through the activation of caspases-3, -8 and -9 [1]. On the other hand, enediynes fused to maleimide were supposed to provide cytotoxic activity due to the formation of radicals through the maleimide-assisted rearrangement and cycloaromatization (MARACA) [2]. Some heteroindene-fused enediynes showed cytotoxic activity against NCI-H460 lung cancer cells [3]. Nevertheless, the precise mechanism of action of acyclic enediynes remains incompletely elucidated. Therefore, the synthesis of new acyclic enediynes and the study of their biological activity is an urgent task.

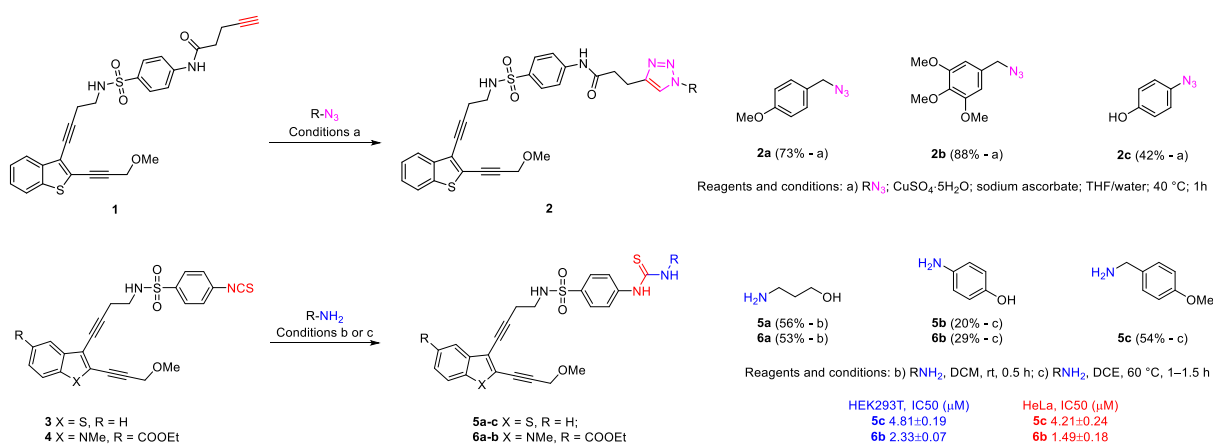

**Scheme 1.** Approaches to the synthesis of acyclic enediyne conjugates.

To synthesize new acyclic enediynes conjugated to different ligands, we chose click reactions, namely CuAAC and the interaction of isothiocyanates with amine ligands. For aliphatic amines and azides, the reactions proceeded with good yields ranging from 53 to 88%. However, when we moved to *p*-azidophenol and *p*-aminophenol, the reaction yields of modified enediynes ranged from 20 to 42%.

The cytotoxicity of the obtained acyclic enediynes was investigated for HEK293T and HeLa cell lines. Triazole derivatives of acyclic conjugates **3a-c** showed quite low activity towards both cell lines.

All synthesized thiourea derivatives of acyclic enediynes **5,6** showed cytotoxic effects on both cell lines at concentrations <10 μM. Compounds **5c** and **6b** displayed cytotoxicity at concentrations below 5 μM. In addition, enediyne **6b** showed some selectivity towards HeLa tumour cells compared to the normal human embryonic kidney cell line HEK293T.

In conclusion, our findings indicate that acyclic enediynes fused to benzothiofene and indole represent a promising class of cytotoxic compounds for further development.

## References

- [1] *Bioorg. Med. Chem.* **2007**, *15*, 4528-4536
- [2] *J. Org. Chem.* **2020**, *85*, 9808-9819
- [3] *Org. Biomol. Chem.* **2024**

## Acknowledgements

This work was supported by the Russian Science Foundation (project No 21 13 00218).



# A REMARKABLE ARRAY OF COBALT- PROTECTED CYCLOALKYNE REAGENT PRECURSORS OBTAINED VIA NICHOLAS CYCLIZATION

Kim M.D.<sup>1</sup>, Kaminskiy N.A.<sup>1</sup>, Govdi A.I.<sup>1</sup>, Danilkina N.A.<sup>1</sup>

<sup>1</sup> St. Petersburg State University, St. Petersburg, Russia  
Student

[miakim2001@gmail.com](mailto:miakim2001@gmail.com)

Strain-promoted azide-alkyne cycloaddition (SPAAC) is one of the most preferable biorthogonal click reactions, which play a substantial role in modern chemical biology [1]. The unique properties of the azido group, the absence of toxic Cu(I) and the rapid kinetics provide a wide range of SPAAC applications in chemistry and biology [2]. Therefore, development of new synthetically accessible SPAAC reagents with improved properties, especially SPAAC kinetics, is of crucial importance.

As medium-sized cycloalkynes are difficult to obtain due to ring strain and the possible kinetic instability, the Nicholas cyclization has become a unique tool for the synthesis of cyclooctynes and cyclononynes, as the generated cyclic Co-complexes stabilize strained cycloalkyne geometry [3].

Recently, in our research group a new class of SPAAC reagents – heterocycloalkynes fused to a heterocyclic core – has been discovered [4]. In attempt to obtain more reactive yet stable members of this family, we turned to triazole-fused cycloalkynes. We investigated the synthetic accessibility and stability of two novel triazole-fused cyclooctynes and cyclononynes.

Co-complexes of 8-membered cycles **3a,b** were obtained by the intramolecular Nicholas reaction using an arene moiety as a nucleophile. The synthetic chain started from a proper alkyne **1** and included a four-step sequence of iodination, CuAAC, the Sonogashira coupling and the Nicholas reaction of intermediate complex **2**. The stability of the corresponding free of Co cycloalkynes is under investigation.

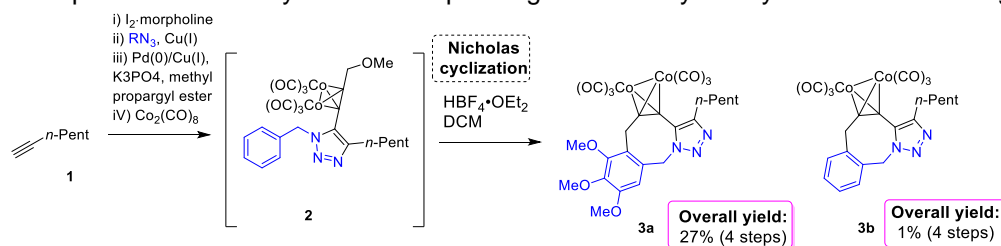

**Scheme 1.** Synthesis of Co-complexes of triazole-fused cyclooctynes.

For the synthesis of 9-membered Co-complexes **6** we used N-Nicholas cyclization of triazole **4**. It should be noted that these 4-unsubstituted triazole **4** can be obtained using a one-pot reaction of diazomethanesulfonamide, amine and aldehyde [5]. We were pleased to note that after Co-decomplexation, the obtained cyclononyne **7** was stable under isolation and storage. Synthesis of corresponding 4-substituted analogues and SPAAC reactivity of triazole-fused cyclononynes is currently ongoing.

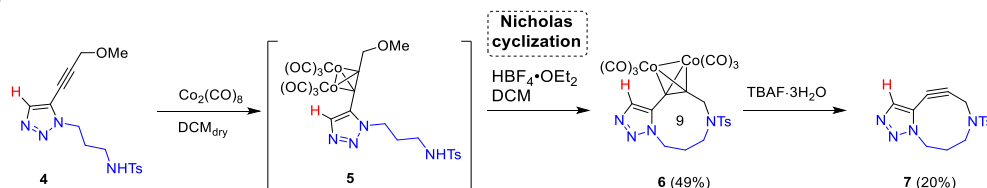

**Scheme 2.** Synthetic approach towards triazole-fused cyclononynes.

## References

- [1] *J. Am. Chem. Soc.* **2004**, *126*, 15046
- [2] *Acc. Chem. Res.* **2011**, *44*, 666
- [3] *Angew. Chemie Int. Ed.* **2015**, *54*, 1190
- [4] *J. Am. Chem. Soc.* **2021**, *143*, 16519
- [5] *J. Org. Chem.* **2021**, *86*, 17516

## Acknowledgements

This work was supported by the Russian Science Foundation (project No 24-23-00377).

# RHODIUM COMPLEXES WITH PLANAR-CHIRAL CYCLOPENTADIENYL LIGANDS ASSEMBLED FROM ALKYNES

Kolos A.V.<sup>1</sup>, Nelybina Y.V.<sup>1</sup>, Perekalin D.S.<sup>1</sup>

<sup>1</sup> A.N. Nesmeyanov Institute of Organoelement Compounds (INEOS),  
Russian Academy of Sciences, Moscow, Russia

Student

[kolos.andreij@gmail.com](mailto:kolos.andreij@gmail.com)

The synthesis of cyclopentadienyl rhodium complexes typically follows a two-stage process. Initially, a substituted cyclopentadiene ligand is synthesized, followed by the coordination of this ligand to the metal center. In our research, we discovered that the cyclization of alkynes in the metal coordination sphere offers a potent one-step approach for synthesizing cyclopentadienyl rhodium complexes. Several rhodium catalysts with planar-chiral cyclopentadienyl ligands can be obtained by the reaction of cyclooligomerization of tert-butyl-acetylene in coordination sphere of the commercially available [(cod)RhCl]<sub>2</sub>. Depending on the reaction conditions, complexes comprising three (**1**) or four (**2**) alkyne molecules can be formed. Cross-cyclization reactions are also possible when internal alkynes are added. The structure of the resulting products depends (**3**) on the nature of the substituents in alkynes

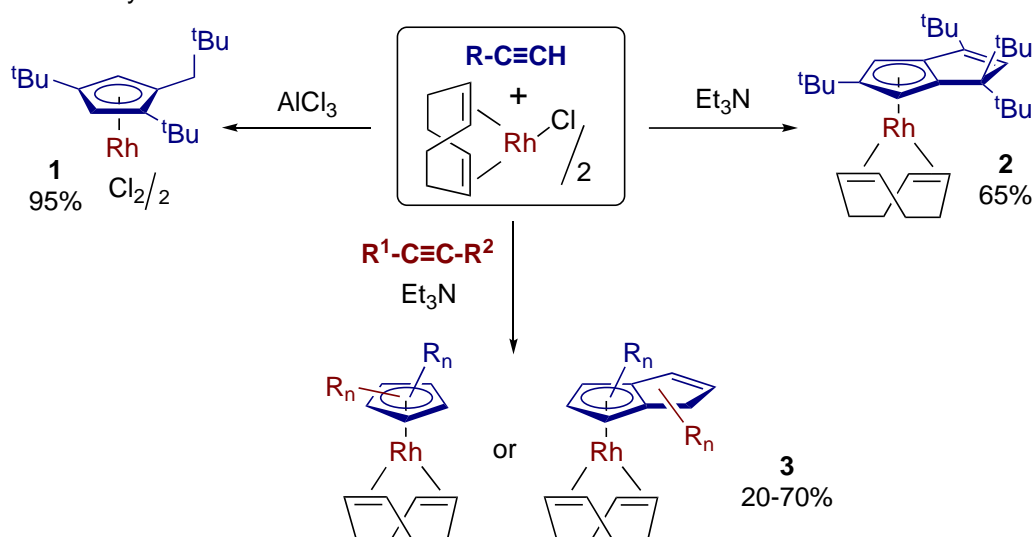

**Scheme 1.** Synthesis of cyclopentadienyl rhodium complexes via cyclization of alkynes.

The racemic complexes were resolved into pure enantiomers by crystallization with L-proline or chromatographic separation of their diastereomeric adducts with L-phenylglycinol. The chiral complexes catalyze C-H activation of arylhydroxamates to give valuable dihydroisoquinolones (**4**) in excellent yields with high regio- and stereoselectivity (>90% ee).

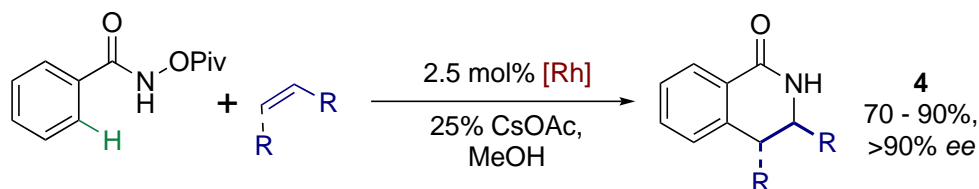

**Scheme 2.** Catalytic performance of rhodium complexes in the annulation of O-pivaloyl-hydroxamate.

## References

- [1] *Angew. Chem. Int. Ed.* **2018**, *57*, 7714
- [2] *Organometallics* **2021**, *40*, 3712
- [3] *Dalton Trans.* **2023**, *52*, 17005

## Acknowledgements

This work was supported by the Russian Science Foundation (project No 23-13-00345).

## INDUSTRIALLY APPLICABLE PHOSGENE-FREE SYNTHESIS OF ARYL ISOCYANATES

Kolychev E.L., Tretyakova N.A., Sulimov A.V., Ovchinnikov K.A., Sladkovsky D.A., Stepanchuk A.P.

[kolychev.el@gazprom-neft.ru](mailto:kolychev.el@gazprom-neft.ru)

Nowadays, industrial enterprises around the world use the obsolete technology for production of di- and polyisocyanates used as components of polymeric materials, such as polyurethanes and polyureas. The key stage of this technology is the production of phosgene from carbon monoxide and chlorine with subsequent phosgenation of aromatic and aliphatic di- and polyamines. The technology not only requires the application of highly toxic phosgene, but also rely on chlorinated aromatic solvents, which in turn requires their large-scale production to ensure the economic feasibility of isocyanate production itself. Consequently, this require the establishment of multiple large-scale production facilities, which often have significant environmental implications. Furthermore, the phosgenation process releases substantial quantities of hydrogen chloride, accompanied by various organic impurities, demanding additional infrastructure for the management and disposal of these by-products. The presence of reactive chlorine-containing residues in isocyanates adversely impacts their quality and reactivity. Thus, the establishment of large-scale isocyanate production is currently justifiable primarily in regions where historical production frameworks exist, supported by a legacy of available chemical intermediates from the mid-20th century, or where environmental regulations are less strict.

Innovative technologies for production of di- and polyisocyanates have emerged, utilizing recent advancements in metal complex catalysis and adhering to modern environmental standards. The second generation of production processes for aromatic isocyanates employs non-toxic and stable carbon monoxide precursors, such as organic carbonates or ureas. Reaction of these compounds with amines yields carbamates, which can subsequently undergo thermolysis to produce isocyanates. The third generation involves the direct reaction of carbon monoxide with nitro compounds, which serve as precursors for amines. Initial research was focused on the direct conversion of nitroaromatic compounds to isocyanates. However, this method is hampered by harsh reaction conditions and low selectivity due to the rapid transformation of the resulting highly reactive isocyanates to various side products. A more viable strategy has emerged, which includes the intermediate formation of carbamate from a nitro compound, carbon monoxide, and an appropriate alcohol. Current theoretical and experimental investigations are aimed at developing and implementing new industrially applicable methods for producing polyurethane components based on these innovative approaches.

## C-N AND C-C BOND FORMATION IN ELECTROOXIDATION REACTIONS OF AROMATIC COMPOUNDS

Kononov A.I.<sup>1</sup>, Strekalova S.O.<sup>1</sup>, Zlygostev A.D.<sup>2</sup>, Khvorova M.A.<sup>2</sup>, Saveliev G.N.<sup>2</sup>, Budnikova Y.H.<sup>1</sup>

<sup>1</sup> Arbuzov Institute of Organic and Physical Chemistry, FRC Kazan Scientific Center of RAS, Kazan, Russia

<sup>2</sup> A.M. Butlerov Institute of Chemistry, Kazan Federal University, Kazan, Russia  
Graduate student

[kononovsnz97@gmail.com](mailto:kononovsnz97@gmail.com)

Electrochemical reactions represent one of the most atom-economical and green approaches to the synthesis of various valuable compounds that are widely applied in pharmaceuticals and organic materials [1]. Direct C-H bond functionalization, especially oxidative C-H/C-H and C-H/N-H cross-coupling through release of H<sub>2</sub> of non-activated aromatic compounds has attracted many chemists because it does not require prefunctionalization of the substrates and it is a simple, efficient, atom- and step-economical way to construct C-C or C-N bonds.

Biaryls are important structural motifs that widely exist in pharmaceuticals, natural products, materials, and are used as ligands for metal catalysts and asymmetric catalysis [2]. Compounds containing amide moieties are widespread in organic materials (polymers, dyes), natural and biologically active compounds (agrochemicals, pharmaceuticals) [3]. Thus, the importance of such compounds is obvious, and the search for new methods for the synthesis of biaryl and compounds containing amide moieties is an important objective.

In this work we have demonstrated the formation of C-C and C-N bond at C(sp<sup>2</sup>)-H and C(sp<sup>3</sup>)-H of arenes to afford a direct synthesis of biaryls and anilides or *N*-benzylamides under mild electrooxidative conditions (room temperature, without metal catalyst, external oxidants or acid) [4-5].

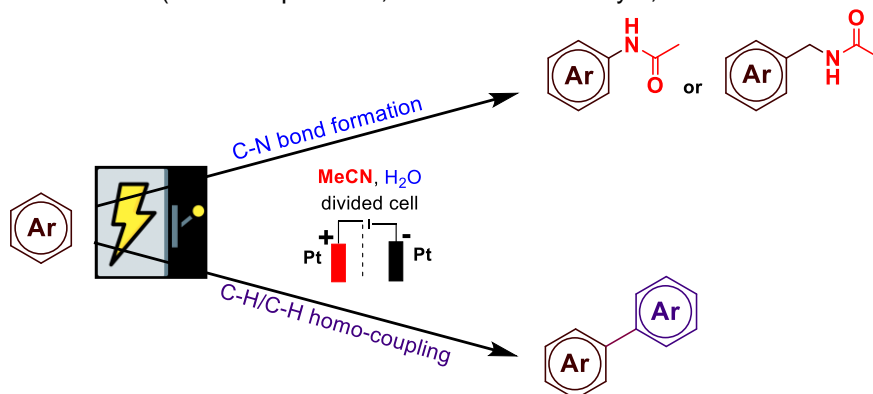

**Scheme 1.** Electrooxidation of arenes to arylamides or biaryls.

Aromatic substrates that oxidize less positive than +2 V or have bromine or iodine substituents undergo homo-coupling reactions and form biaryls (dimers) during anodic oxidation. Difficult to oxidize (more positive than +2 V) aromatic substrates upon electrooxidation preferentially form anilides and *N*-benzylamides when nitrile is a solvent and a source of amidation fragment.

### References

- [1] *Curr. Opin. Electrochem.* **2023**, *40*, 101312
- [2] *Tetrahedron.* **2019**, *75*, 4199
- [3] *J. Med. Chem.* **2016**, *59*, 4443
- [4] *Curr. Res. Green Sust. Chem.* **2024**, *8*, 100406
- [5] *Adv. Synth. Catal.* **2023**, *365*, 3375

### Acknowledgements

This work was supported by the Russian Science Foundation (project № 22-13-00017).

# SINGLET OXYGEN-MEDIATED OXIDATION OF SULFIDES: A KINETIC AND DFT STUDY

*Korobkov S.M.<sup>1</sup>, Birin K.P.<sup>1</sup>, Tsvadze A. Yu.<sup>1,2</sup>*

<sup>1</sup> A.N. Frumkin Institute of Physical Chemistry and Electrochemistry RAS, Moscow Russia

<sup>2</sup> N.S. Kurnakov Institute of General and Inorganic Chemistry RAS, Moscow, Russia

Student

[skor42@inbox.ru](mailto:skor42@inbox.ru)

Porphyrins may produce reactive oxygen species (ROS) upon irradiation and singlet oxygen ( $^1\text{O}_2$ ) is one of them. This method of generation of  $^1\text{O}_2$  is proved to be an efficient protocol for various oxidative transformations of organic substrates [1]. Our research group recently shown that heterocycle-appended porphyrins can be used as photosensitizers for singlet oxygen-mediated oxidation of organic sulfides with impressive TONS up to 98 000 [2].

We decided to thoroughly study the reaction mechanism to understand fundamental principles lying behind the process for further improvement of catalytic efficiency. Indium(III) 5,10,15,20-tetra(4-methoxycarbonylphenyl) porphyrinate (**In(Cl)\_TPP\_CO<sub>2</sub>Me**) was used as a source of  $^1\text{O}_2$  and thioanisole was used as a model sulfide. A large number of kinetic experiments were carried out to describe the role of alcohol and influence of catalyst loading on the catalytic process. Our previously developed approach for measurement of stationary concentration of  $^1\text{O}_2$  in solution was also applied [3]. Furthermore, DFT calculations were carried out to support the proposed reaction mechanism.

Combined use of kinetics and DFT calculations allowed to develop a quantitative model of the reaction for further verification of the model with obtained experimental data (Figure 1). Variation of catalyst loading or methanol mole ratio in the reaction mixture was simulated and compared with experimental data.

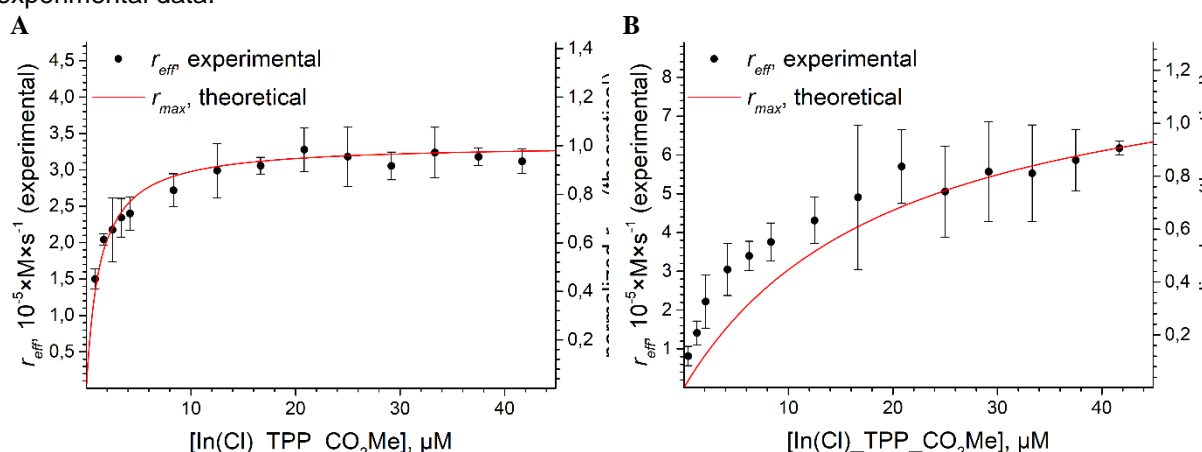

**Figure 1.** Experimental reaction rate (left axis) and theoretically derived normalized reaction rate (right axis) plotted against catalyst concentration. Catalytic experiments were performed in binary mixtures of toluene/methanol (**A**) and CCl<sub>4</sub>/methanol (**B**) (15:85 solvent to methanol mole ratio).

A close agreement between experiment and theory was achieved which indicates good understanding of the reaction mechanism. We attempted to use the acquired theoretical data to boost the catalytic efficiency of existing tetrapyrrolic sensitizer. The widely studied 5,10,15,20-tetraphenylporphyrin (**TPP**) is a reference compound for comparison of new porphyrin-based photocatalysts. Oxidation of dibutyl sulfide with **TPP** in acetic acid or acetic acid/CCl<sub>4</sub> 1:1 mixture (by volume) allowed to achieve TONS up to 300 000 with conversion up to 99% and high selectivity. It corresponds to enhancement of catalytic activity by ca. 2 orders of magnitude compared to existing literature reports [1]. The achieved results form solid base for further development of highly effective systems for  $^1\text{O}_2$ -mediated oxidation of sulfides by selecting appropriate solvent mixtures and using intelligent catalyst design.

## References

[1] *Beilstein J. Org. Chem.* **2020**, *16*, 917–955

[2] *J. Catal.* **2022**, *413*, 342-352

[3] *Dyes Pigm.* **2023**, *220*, 111749

## Acknowledgements

This work was supported by the Russian Science Foundation (project No 23-23-00542).

# COINAGE (Au, Ag, Cu) METAL-CATALYZED (3+2) ANNULATION OF $\alpha$ -AMINOKETONES AND ELECTRON-DEFICIENT ALKYNES AS A ROUTE TO 3-EWG-SUBSTITUTED PYRROLES

*Kotikova P.F., Dubovtsev A. Yu.*

St. Petersburg State University, St. Petersburg, Russia

Student

[polinakoty2002@gmail.com](mailto:polinakoty2002@gmail.com)

Recently a great number of 3-EWG-substituted pyrrole-based compounds found miscellaneous applications in pharmacy. In particular, 3-sulfonylpyrroles attracted significant attention as potent myeloid cell leukemia 1 inhibitors, hepatoselective statins and protein tyrosine kinase inhibitors [1,2].

Conventionally, preparation of various 3-EWG-substituted pyrroles is achieved by multi-step synthetic protocols [3] and therefore a search for modular one-step approaches is a challenging task. In the last decade, several step-saving approaches to 3-substituted pyrroles were proposed however, all these methods exhibit significant drawbacks, such as the use of difficult-to-obtain prefunctionalized substrates [4,5], expensive photocatalysts and irradiation sources [6], or aggressive oxidants, reducing a substituent's tolerance.

We developed a modular (3+2) annulation of  $\alpha$ -aminoketones and electron-deficient alkynes leading to 3-EWG-substituted pyrroles. This reaction is catalyzed by the whole triad of coinage metals (Au, Ag, Cu). The optimal coinage metal-catalyzed conditions demonstrate good tolerance to functional substituents, and this feature allowed the synthesis of a library of diverse 3-EWG-substituted pyrroles.

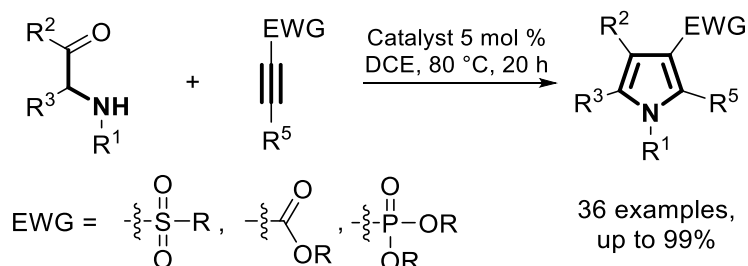

**Scheme 1.** Coinage (Au, Ag, Cu) metal-catalyzed (3+2) annulation of  $\alpha$ -aminoketones and electron-deficient alkynes.

## References

- [1] *J. Med. Chem.* **2021**, *64*, 11330
- [2] *Bioorg. Med. Chem. Lett.* **2008**, *18*, 1151
- [3] *Synthesis.* **2019**, *51*, 4023
- [4] *J. Org. Chem.* **2013**, *78*, 7508
- [5] *New J. Chem.* **2017**, *41*, 8791
- [6] *Angew. Chem. Int. Ed.* **2018**, *57*, 14787

## Acknowledgements

This work was supported by the Russian Science Foundation (project No 23-73-10008).

POLYIONIC VESICLES FOR TARGETED DELIVERY OF THE THERAPEUTIC ENZYME  
METHIONINE- $\gamma$ -LYASE

*Koval V.S.*<sup>1</sup>, *Morozova E.A.*<sup>1</sup>, *Kulikova V.V.*<sup>1</sup>, *Revtovich S.V.*<sup>1</sup>, *Chobanyan A.A.*<sup>1</sup>, *Sidorova A.I.*<sup>1</sup>,  
*Solyev P.N.*<sup>1</sup>

<sup>1</sup> Engelhardt institute of Molecular Biology RAS, Moscow, Russia  
Junior Researcher, Ph.D.  
[tokojami@yandex.ru](mailto:tokojami@yandex.ru)

Pyridoxal-5'-phosphate-dependent methionine- $\gamma$ -lyase (MGL) catalyzes the reactions of  $\beta$ - and  $\gamma$ -elimination of sulfur-containing amino acids, which suggests two strategies for its use in anticancer therapy – as an antitumor agent, and as a component of the pharmacological pair (MGL + S-alkyl-L-cysteine sulfoxides) in enzyme prodrug therapy. However, the introduction of enzymes into the bloodstream is limited by their high immunogenicity and low bioavailability. One of the options to solve the problem of *in vivo* application of the enzyme is the encapsulation of MGL into synthetic polymersomes/vesicles based on polyion complexes (PICsomes).

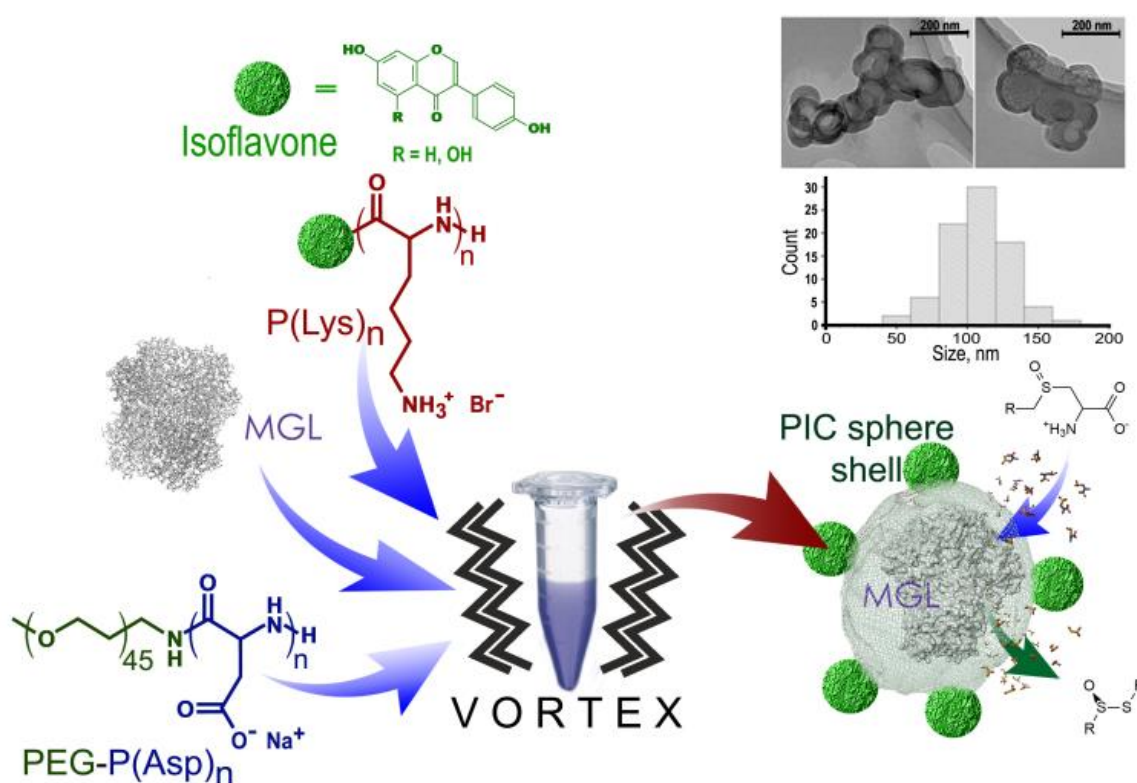

**Scheme 1.** Generation of PICsomes containing methionine- $\gamma$ -lyase.

The selection of the optimal ratio of enzyme and polymers, the study of the influence of the length of polymer chains on the degree of inclusion of the enzyme and the size of the resulting nanoreactors, and the assessment of the rate of MGL release from PICsomes were carried out. It was shown that the polymer shell is permeable to the substrate while MGL retains its activity inside the nanocapsule. The shape and size of PICsomes with the encapsulated enzyme were proven by AFM and TEM methods. For targeted delivery of nanoreactors to the surface of cancer cells we coupled the PICsomes with polylysine chains containing phytoestrogens daidzein (Dz) and genistein (Gn) which have high affinity for estrogen receptors. Dz/Gn nanoreactors were shown to bind to the surface of ER<sup>+</sup> and GPR30<sup>+</sup> adenocarcinoma cells and in the presence of sulfoxides they formed cytotoxic thiosulfinates *in vitro* and *in vivo*. The toxicity of nanoreactors and their individual components was studied in mouse embryos. High rates of blastocyst formation (>80%) were observed for all tested components and the nanoreactors themselves.

**Acknowledgements**

This work was supported by the Russian Science Foundation (project № 20-74-10121-P).

# HALOGENATED SPIROPYRANS' DERIVATIVES AS PROMISING BUILDING BLOCKS FOR SMART MATERIALS

*Kozlenko A.S.<sup>1</sup>, Pugachev A.D.<sup>1</sup>, Makarova N.I.<sup>1</sup>, Rostovtseva I.A.<sup>1</sup>, Metelitsa A.V.<sup>1</sup>, Ozhogin I.V.<sup>1</sup>*

<sup>1</sup> Institute of Physical and Organic Chemistry of Southern Federal University, Rostov-on-Don, Russia

Ph.D., junior researcher

[kozlenko@sfedu.ru](mailto:kozlenko@sfedu.ru)

Over the past few decades, interest in spiropyrans (SPP) has been steadily increasing. The notable difference in geometrical and electronic structures between the Sp and Mc forms (Scheme 1A) renders them promising building blocks for various types of smart materials [1]. Moreover, the ease of synthesizing SPPs and the potential for fine-tuning their properties through minimal structural modifications are of great importance. Despite the extensive research in this field, certain aspects of the structure-properties relationship in SPPs remain poorly understood. For instance, halogenated SPPs are of particular interest due to their potential use as individual photoswitches, modification via cross-coupling reactions, or incorporation into different materials. However, there is currently limited research in this area. For example, it has been observed that brominated cationic SPP **3** exhibits a tendency to form long-lived photoinduced Mc with near-infrared (NIR) fluorescence [2]. It is noteworthy that such cationic SPP derivatives is promising for bioimaging applications [3]. In the present study, we aimed to investigate the influence of cationic fragments, electron-donating methoxy groups, and types of halogen substituents on the spectral and kinetic properties of SPPs. Five new SPPs (**5-9**) with methoxy groups in the indoline and indolium fragments were synthesized and studied. Additionally, data on previously known SPPs (**1-4**) are provided for comparison [2,4] (Scheme 1B).

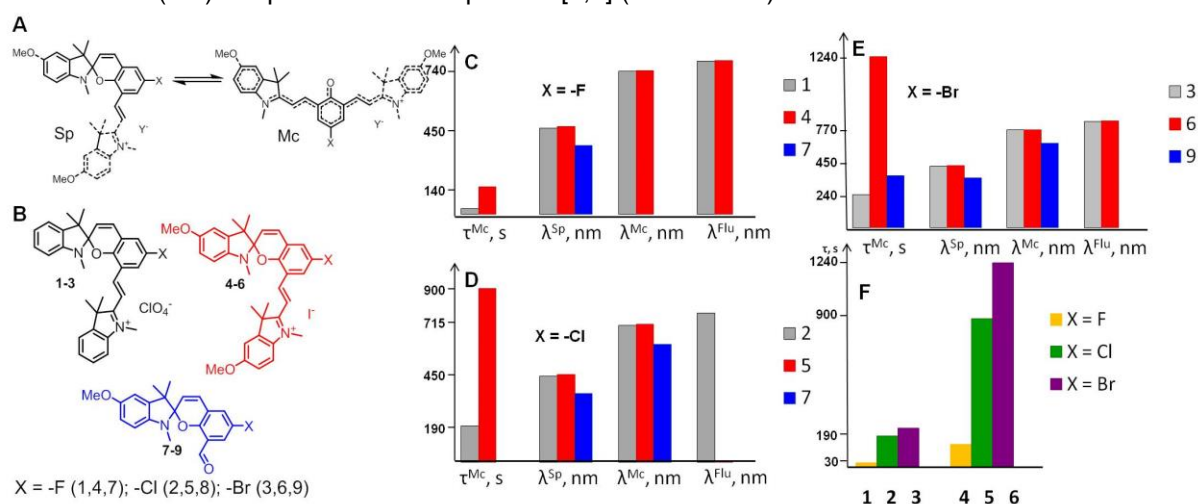

**Scheme 1.** General scheme of SPP isomerization (A), structures of discussed compounds (B), spectral and kinetic parameters' ratio for discussed compounds grouped by halogen type (C-E) or methoxy group presence/absence (F).

According to the results obtained, elongating the conjugation chain by adding a vinyl-3*H*-indolium substituent leads to an increase in both Sp and Mc absorption maxima wavelengths (Scheme 1C-E). In two out of three cases, it also enhances the compounds' ability to undergo photochromic transformation, or significantly increases the photoinduced Mc lifetime in the case of SPPs **6** and **9**. The addition of methoxy groups at the ends of the conjugation chain also stabilizes the Mc form (Scheme 1F). The cationic fragment's effect on photochromic properties and the absence of photosensitivity in some cases and were further investigated through TD-DFT calculations based on electron density distribution analysis. The crucial role of the heavy atom effect in the case of bromosubstituted species was illustrated.

## References

- [1] *Top. Curr. Chem.* **2023**, 381, 8
- [3] *Spectrochim Acta A Mol Biomol Spectrosc.* **2020**, 230, 118041
- [4] *Photochem. Photobiol. Sci.* **2023**, 22, 2651-2673
- [5] *ChemistrySelect.* **2024**, 9, e202400058

## Acknowledgements

This work was supported by the Ministry of Science and Higher Education of the Russian Federation; project FENW-2023-0020.



# NEW FLUOROPHORES BY THE INTEGRATION OF THE 2-ARYL-1,2,3-TRIAZOLE AND THIAZOLE RINGS

*Krasilnikov V.A.<sup>1</sup>, Fomin T.O.<sup>1</sup>, Vargina M.V.<sup>1</sup>, Belskaya N.P.<sup>1</sup>*

<sup>1</sup> Ural Federal University, Yekaterinburg, Russia

Master student

[kras\\_vitalii@mail.ru](mailto:kras_vitalii@mail.ru)

The molecular hybridization may be an attractive technique where combines two or more heterocycles into new hybrid compounds as a new fluorescent integrity that can inherited photophysical characteristics and physicochemical properties from the parent molecules. From other side, the resultant hybrids can acquire another and new properties, for instance, spectrum of photophysical characteristics, physicochemical properties, and sensitivity to different chemical and biological stimuli, biological behaviour [1].

Based on this concept, we chose 2-aryl-4-cyano-1,2,3-triazoles **1** as an intensive blue fluorophore to adjust their photophysical and physicochemical characteristics and give rise to new properties by modifying and redesigning its structures that could expand the scope of their application [2]. On the other hand, thiazole represents another kind of an important heterocycle framework that is often used to fluorescent molecules design [3]. The wealth of information on the photophysical properties of the above-mentioned heterocyclic systems inspired us to design a new fluorophore scaffold by integration of these heterocycles. We synthesized and studied photophysical properties of the novel molecular hybrids containing an assemble of 1,2,3-triazole and thiazole rings in the molecule.

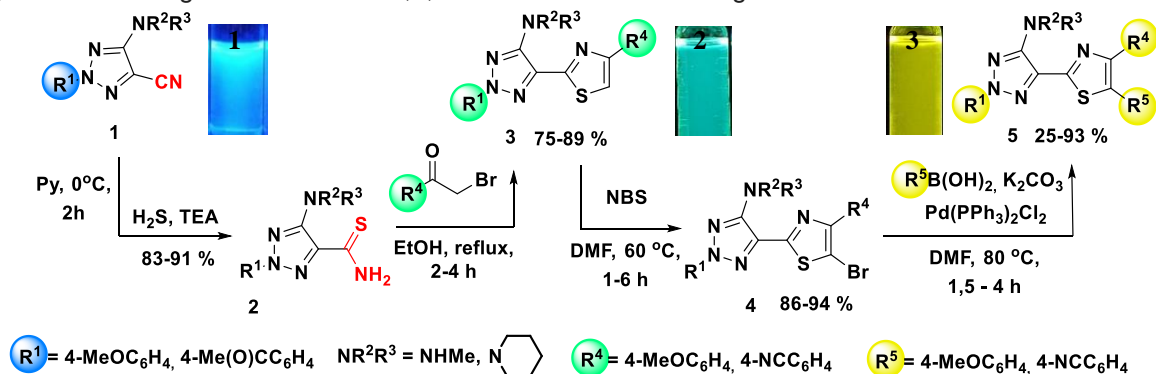

**Scheme 1.** Preparation of triazolylthiazoles **3** and **5** and photographs of solutions in DMSO.

A study of the optical properties of 4-aryl-2-triazolythiazoles **3** showed that the introduction of a 1,3-thiazole ring leads to a bathochromic shift of absorption bands ( $\lambda_{\text{abs}} =$  up to 400 nm) and excitation bands ( $\lambda_{\text{em}} =$  up to 495 nm). Addition of aromatic substituent  $R^5$  to the C5 atom of the thiazole ring in compounds **5** resulted in yellow and green fluorescence ( $\lambda_{\text{em}} = 501\text{--}538$  nm).

## References

- [1] *J. Photochem. Photobiol. C* **2022**, *53*, 100553  
 [2] *Dyes Pigms.* **2020**, *178*, 108343  
 [3] *Targets Heterocycl. Syst.* **2020**, *23*, 116-142

## Acknowledgements

The study was carried out with financial support from the Ministry of Science and Higher Education of the Russian Federation within the framework of the Development Program of the Ural Federal University named after the first President of Russia B.N. Yeltsin in accordance with the strategic academic leadership program "Priority 2030" and "UrFU academic mobility program".

## SYNTHESIS OF NEW TETRAZINE-BASED POLYNITROGEN STRUCTURES

*Kryazh V.V.,<sup>1,2</sup> Fershtat L.L.<sup>1</sup>*

<sup>1</sup> Zelinsky Institute of Organic Chemistry, Russian Academy of Sciences, Moscow, Russia,

<sup>2</sup> National Research University "Higher School of Economics", Faculty of Chemistry, Moscow, Russia  
Student

[vkryazh@ioc.ac.ru](mailto:vkryazh@ioc.ac.ru)

The chemistry of s-tetrazine derivatives remains a relatively poorly studied area of organic chemistry despite that this heterocyclic fragment is very important for the preparation of practically important substances. Among the topical applications of s-tetrazine derivatives are photoactive elements, biological markers, pharmaceuticals and energy-rich materials. The development of new molecular systems containing the central core of s-tetrazine is one of the relevant tasks of synthetic organic chemistry.

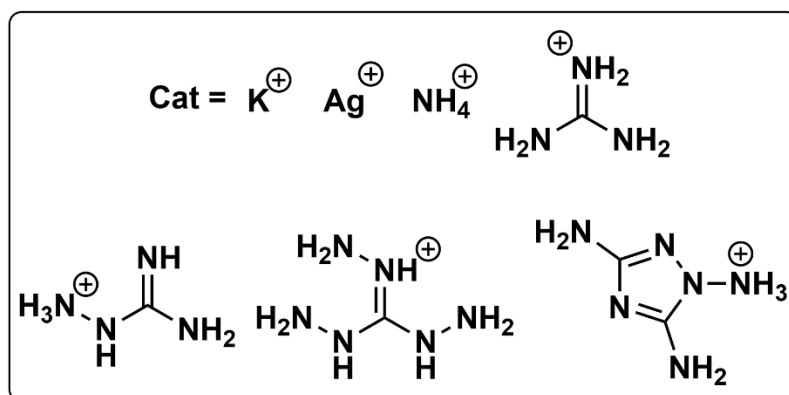
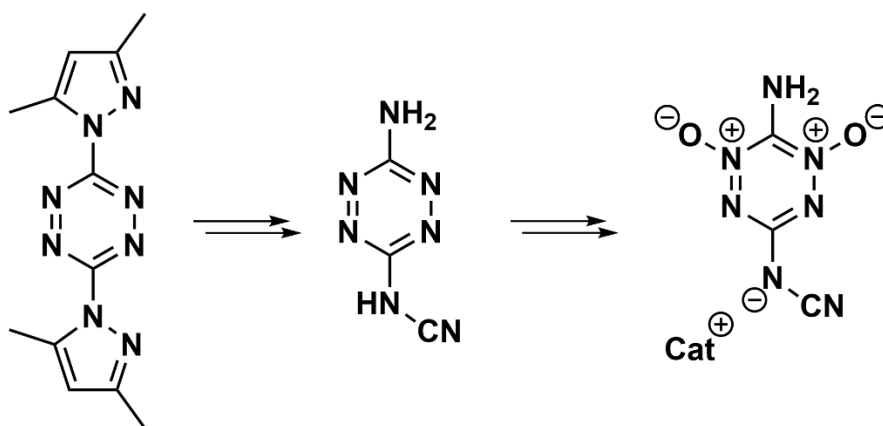

**Scheme 2.** General scheme for the preparation of ionic salts of 3-cyanamide-6-amino-1,2,4,5-tetrazine-1,5-dioxide.

In this work, we have developed an approach to obtain new high-energy tetrazine-based salts with different cations. Based on successive transformations of the available 3,6-bis(1,5-dimethyl-1H-pyrazol-1-yl)-1,2,4,5-tetrazine, we have prepared energetic structures containing the 3-cyanamide-6-amino-1,2,4,5-tetrazine-1,5-dioxide fragment as an anionic component. The proposed method, unlike the existing ones, has a small number of stages and is characterized by high conversions and yields.

DONOR-ACCEPTOR CYCLOPROPANES WITH A PHOSPHONATE GROUP AS AN ACCEPTOR:  
SYNTHESIS, PROPERTIES

*Kuleshov A.V.<sup>1</sup>, Andreev I.A.<sup>2</sup>, Ratmanova N.K.<sup>2</sup>, Trushkov I.V.<sup>1,2</sup>*

<sup>1</sup> N. D. Zelinsky Institute of Organic Chemistry Russian Academy of Sciences, Moscow, Russia

<sup>2</sup> Dmitry Rogachev National Medical Research Center of Pediatric Hematology, Oncology and Immunology, Moscow, Russia  
PhD student

[andrei.kuleshov.98@gmail.com](mailto:andrei.kuleshov.98@gmail.com)

The goal of this work was the synthesis and nucleophilic ring opening of donor-acceptor cyclopropanes containing a phosphonate group as one of the acceptors as well as subsequent modifications of the primary products. The presence of a phosphonate group allows, after ring opening by nucleophiles, to carry out the Horner-Wadsworth-Emmons reaction, that significantly expands the possibilities of post-modification compared to classical cyclopropane-1,1-dicarboxylates. To realize this goal, a wide range of phosphonoacrylates **2** were obtained by Knoevenagel condensation using modified reaction conditions, which were then converted to the corresponding cyclopropanes **3** by Corey-Chaykovsky reaction. The resulting cyclopropanes were opened with anilines; products were converted to the corresponding pyrrolidones **5** according to the previously described conditions [1]. Finally, the Horner-Wadsworth-Emmons reaction was performed to obtain arylidene-substituted pyrrolidones **6**. It is worth noting that the resulting structures have pronounced biological activity and can be used as nootropics and antidepressants.

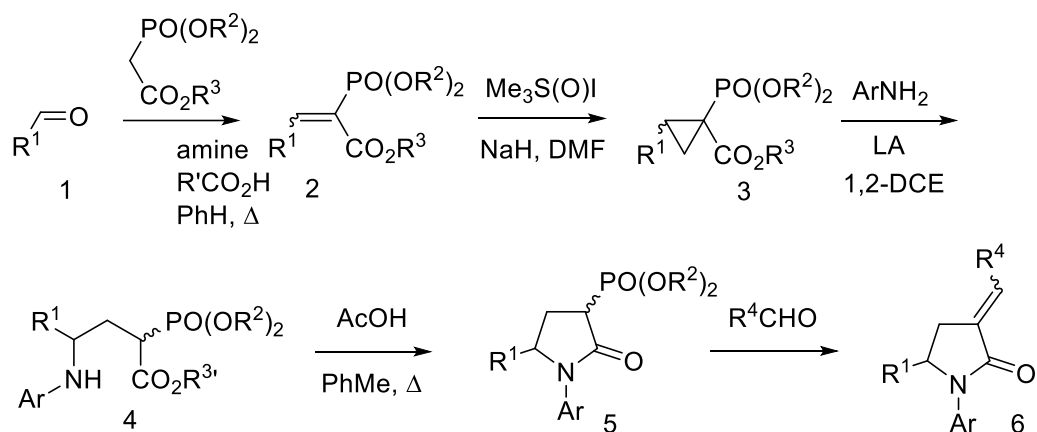

**Scheme 1.** General scheme of the studied transformations.

**References:**

[1] *Molecules* **2022**, *27*(23), 8468

**Acknowledgements**

This work was supported by Russian Science Foundation (project 24-13-00255).

## APPLICATION OF MULTIPLEXED ELECTROSPRAY FOR MICRODROPLET CHEMICAL SYNTHESIS PROBLEMS

*Kuleshov D.O.*<sup>1,2</sup>, *Gromov I.A.*<sup>1</sup>, *Pikovskoi I.I.*<sup>3</sup>, *Onuchina A.A.*<sup>3</sup>, *Voronov I.S.*<sup>3</sup>

<sup>1</sup> Institute for Analytical Instrumentation RAS, St. Petersburg, Russia

<sup>2</sup> Microdroplet technologies LLC, St. Petersburg, Russia

<sup>3</sup> Core Facility Center "Arktika", M.V. Lomonosov Northern (Arctic) Federal University, Arkhangelsk, Russia

Associate researcher

[hellchemist@yandex.ru](mailto:hellchemist@yandex.ru)

A new method of chemical synthesis involving chemical reactions in micro and nanodroplets, including charged ones, under aerosol conditions is being actively developed at present. High efficiency of using microdroplets for chemical reactions in them is shown [1,2]. The efficiency is expressed in a significant acceleration of chemical reactions (up to a millions-fold in certain cases), as well as in the change in the nature of the reactions which makes it possible to obtain substances that are extremely difficult to synthesize using conventional synthesis methods [3]. However, the wide implementation of microdroplet chemical synthesis is hindered by its low productivity and high solvent consumption.

It seems that the optimal approach to increase the productivity of microdroplet synthesis is the use of spray methods that allow the generation of electrically charged microdroplets. The presence of electric charge in the droplet is a significant advantage of these methods over alternative methods of microdroplet generation, because it opens up a wide range of possibilities for controlling microdroplet parameters such as lifetime, size, electric charge value, trajectory of motion, which, accordingly, will enable controlling such characteristics of chemical reactions as rate and selectivity. The use of these methods will increase the productivity of microdroplet synthesis by increasing the number of spray capillaries, as well as increasing (up to a certain limit) the volume of sprayed liquid per unit time (through a single capillary).

To study the scale-up of microdroplet chemical synthesis, we have designed and fabricated the experimental setup - the microdroplet chemical reactor prototype, which is based on chemical reactions in charged microdroplets generated by multiplexed pneumatic/electrospray. The operation of the microdroplet chemical reactor prototype was tested on the example of the condensation reaction of phenylhydrazine with cyclohexanone. With the use of the device, both in conditions of electrospray of the reaction mixture and in conditions of its pneumatic spray it was possible to achieve a significant acceleration of the reaction with the formation of cyclohexanone phenylhydrazone relative to its occurrence in the bulk solution. Under electrospray conditions, the maximum value of the apparent acceleration factor AAF for this reaction exceeded  $83 \times 10^6$ , under pneumatic spray conditions, the maximum value of AAF, which was achieved for this reaction, was  $80 \times 10^6$ . The device sprays a liquid flow fed at a rate of up to 17 mL/min, while maintaining the effect of accelerating the chemical reaction. The productivity of the device can reach several grams per hour. The presented experimental setup – the microdroplet chemical reactor prototype will find application both in applied tasks of chemical synthesis and in fundamental research in the field of microdroplet chemical synthesis.

### References

[1] *Int. J. Mass Spectrom.* **2021**, 468, 116639

[2] *Annu. Rev. Phys. Chem.* **2020**, 71, 31

[3] *J. Anal. Chem.* **2020**, 75, 1647

### Acknowledgements

The work was supported by Foundation for Assistance to Small Innovative Enterprises in the Scientific and Technical Sphere (Start-22-1 (Archipelago), contract 4732GS1/79601 dated 09/27/2022).

## NICHOLAS REACTION IN CYCLOALKYNE-SULFAMATES SYNTHESIS

*Kutuzov I.A.<sup>1</sup>, Danilkina N.A.<sup>1</sup>*

<sup>1</sup> St. Petersburg State University, St. Petersburg, Russia

Student

[yakutuzoff@gmail.com](mailto:yakutuzoff@gmail.com)

Modern bioorthogonal chemistry exploits many ways to improve the reactivity and stability of cycloalkynes, which are employed in the strain-promoted azide-alkyne 1,3-dipolar cycloaddition (SPAAC). The introduction of endocyclic electron-withdrawing groups to the cyclic structure and strain activation are known as two main approaches to the fine-tuning of the molecular properties of cycloalkynes [1]. Sulfamate moiety has been successfully introduced into the cycloalkyne structure, allowing the activation by stereoelectronic effects [2]. The common synthetic pathway includes the Rh-cyclization of TMS-allenes followed by the desilylation with ring expansion.

This work suggests an alternative approach to the synthesis of sulfamate cyclooctynes using their  $\text{Co}_2(\text{CO})_6$ -complex precursors, which are available via the Nicholas reaction [3]. Such synthetic protocols open the way to the synthesis of cycloalkynes under mild conditions without the need for gold- and rhodium catalysis [2].

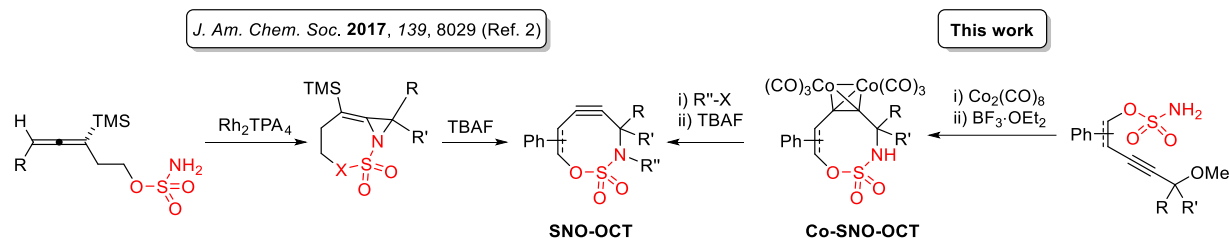

**Scheme 1.** Cyclooctyne sulfamates: know approach vs Nicholas cyclization.

We demonstrate that a variety of  $\text{Co}_2(\text{CO})_6$ -complex precursors can be synthesized by this approach. We also show that sulfamate cycloalkynes can be modified with different agents in the form of Co-complexes ( $\text{R}''\text{X}$  = acyl or alkyl halides, Scheme 1), which eliminates the need to employ somewhat harsh conditions on the sensitive cycloalkyne structure. Cyclic  $\text{Co}_2(\text{CO})_6$ -complexes of alkyne-sulfamates can be easily converted to free of cobalt cyclooctynes using known TBAF protocol [3]. The stability and reactivity of corresponding cyclooctyne-sulfamates will be discussed.

### References

- [1] *Mendeleev Commun.* **2019**, 29, 237-248  
 [2] *J. Am. Chem. Soc.* **2017**, 139, 8029-8037  
 [3] *J. Am. Chem. Soc.* **2021**, 143, 16519-16537

### Acknowledgments

This work was supported by the Russian Science Foundation (project No 24-23-00377).

# LINEAR OLIGOSACCHARIDE FRAGMENTS OF *BRUCELLA* CYCLIC $\beta$ -(1 $\rightarrow$ 2)-GLUCAN: SYNTHESIS, NMR AND IMMUNOCHEMICAL INVESTIGATION

*Anton N. Kuznetsov*<sup>1,2</sup>, *Vadim B. Krylov*<sup>1</sup>, *Nikolay E. Nifantiev*<sup>1</sup>

<sup>1</sup> N.D. Zelinsky Institute of Organic Chemistry, Moscow, Russia

<sup>2</sup> Mendeleev University of Chemical Technology, Moscow, Russia

Student

[antonqzn@gmail.com](mailto:antonqzn@gmail.com)

Brucellosis is zoonotic infection caused by *Brucella* spp. bacteria. Infection afflicts cattle and humans widely across the globe. Current veterinary standards of brucellosis eradication in livestock require culling of cattle that hugely impacts economy. Modern problems with brucellosis diagnostics, treatment and prevention cause the necessity for interdisciplinary studies of bacterial surface antigens, such as carbohydrates. One of the *Brucella* polysaccharides, cyclic  $\beta$ -(1 $\rightarrow$ 2)-glucan (C $\beta$ G), still has controversial opinions about its applicability in diagnostics and immunization against brucellosis. Herein, the full synthesis of its linear fragments and their conjugates is described for the first time. For carrying out the full synthesis of oligosaccharides acetimidate donor was obtained. Acetyl group at O-2 plays double role as a neighboring group participating in selective 1,2-*trans*-glycosidic bond synthesis, and as temporary protecting group. Although the desired  $\beta$ -(1 $\rightarrow$ 2)-linked di- and trisaccharides can be easily obtained using standard methods, the synthesis of longer chains has appeared to be challenging. Effective glycosylation reactions was achieved only in toluene, but not in DCM commonly used for glycosylation.

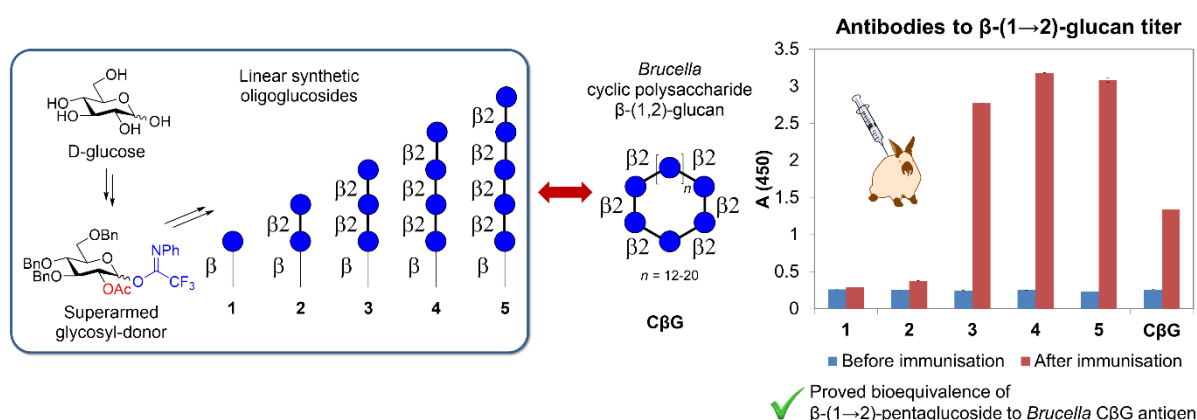

**Scheme 1.** Array of synthesized linear oligo- $\beta$ -(1 $\rightarrow$ 2)-glucosides **2-5** and their use for profiling rabbit blood sera before and after immunization with synthetic penta- $\beta$ -(1 $\rightarrow$ 2)-glucoside **5** glycoconjugate.

NMR-studies revealed pentasaccharide as minimal size fragment for modeling C $\beta$ G polysaccharide properties. It was used for ELISA screening of human donors sera which result in detection of antibodies specific to  $\beta$ -(1 $\rightarrow$ 2)-glucan in  $\sim$ 10% of samples, however no relation to *Brucella* infection was established. Profiling of highly-specific to  $\beta$ -(1 $\rightarrow$ 2)-glucan sera samples revealed complex dependency on oligosaccharide chain length, which can be explained by non-linearity of  $\beta$ -(1 $\rightarrow$ 2)-oligoglucosides secondary structures.

To confirm the bioequivalence of the synthetic fragment and native C $\beta$ G, antibodies against  $\beta$ -(1 $\rightarrow$ 2)-pentaglycoside were raised by serial immunization of rabbits with the corresponding bovine serum albumin conjugate. Importantly, the antibodies obtained recognized not only linear synthetic oligoglucosides but also the natural C $\beta$ G produced by *Brucella*. These results open new opportunities for veterinary and clinical diagnosis of brucellosis.

## Acknowledgements

This work was supported by the Russian Science Foundation (grant 19-73-30017-P).

# REDIRECTING THE [3 + 2] CYCLOADDITION REACTION BETWEEN PYRIDINIUM YLIDES AND 1-ARYLNITROALKENES TOWARD [4 + 1] ANNULATION

*Kuznetsov N.A.<sup>1</sup>, Samet A.V.<sup>1</sup>*

<sup>1</sup> N. D. Zelinsky Institute of Organic Chemistry, Moscow, Russia

Student, Bachelor's degree

[kuznetsov.ioc@gmail.com](mailto:kuznetsov.ioc@gmail.com)

The [3+2] cycloaddition reaction between pyridinium ylides and unsymmetrical electron deficient alkenes represents a powerful and straightforward tool for constructing functionalized indolizines and indolizidines which are privileged pharmacophore scaffolds. Chemistry of this process is significantly influenced by the structures of both ylide and alkene and has asynchronous nature which sometimes causes the reaction to proceed along a pathway different from [3+2]. Our previous work explored the reaction between unsubstituted pyridinium ylides and nitrostilbenes, which yielded [3+2] cycloadducts with low yields, primarily forming isoxazoline-N-oxides. We proposed a strategic approach involving the simultaneous incorporation of a  $\pi$ -electron-withdrawing group in the meta-position of the ylide and the addition of an oxidant to obtain the desired indolizines [1]. Despite successfully addressing the synthetic challenge, the underlying reasons behind the atypical reactivity of nitrostilbenes remained unknown. Thus, the primary objective of this study was to reveal the fundamental factors responsible for the diversion of [3+2] cycloaddition with pyridinium ylides toward [4+1] upon the introduction of an aryl substituent at position 1 of nitroalkenes. To achieve this, we employed density functional theory calculations (DFT) to gain insights into the mechanistic intricacies. Furthermore, we explored the impact of a meta- $\pi$ -acceptor group in the pyridine ring on the [3+2] cycloaddition reaction and an effect of a substituent at position 1 of nitroalkene. Additionally, effects of solvents and temperature were studied, theoretically and experimentally.

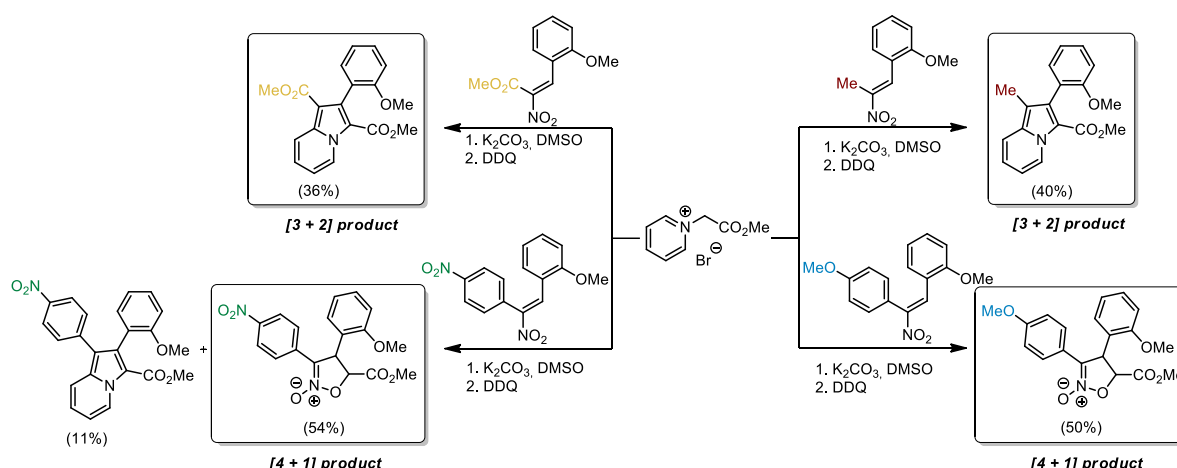

**Scheme 1.** The influence of different substituents in nitroalkenes on the reaction with unsubstituted pyridinium ylide.

We discovered that benzenes are able to level off the  $\pi$ -electron effect of para-substituents with donating and withdrawing properties, contrary to the generally accepted idea about their nature, which, in our case, led to redirecting the [3 + 2] cycloaddition reaction between pyridinium ylides and 1-arylnitroalkenes toward [4 + 1] annulation. Additionally, we proposed the reason of the difference in behavior between meta- $\pi$ -acceptor substituted and unsubstituted pyridinium ylides in [3 + 2] cycloaddition supported by DFT calculations.

## References

[1] *ChemBioChem* **2023**, *24*, e202300161

## Acknowledgements

This work was supported by the Russian Science Foundation (project No 24-23-00109).

# SYNTHESIS OF NEW DONORS OF NON-COVALENT INTERACTION FROM DIARYLIODONIUM SALTS

*Ledneva A.I.<sup>1</sup>, Soldatova N.S.<sup>1</sup>*

<sup>1</sup> Research School of Chemistry and Applied Biomedical Sciences, Tomsk Polytechnic University, Tomsk, Russia

Student

[alyonaledneva@tpu.ru](mailto:alyonaledneva@tpu.ru)

Non-covalent interactions are weak interactions of atoms or molecules without a chemical reaction occurring. This type of interaction, leads to the formation of supramolecular assemblies [1].

A widely known types of such interactions are hydrogen bonding, cation –  $\pi$  interaction,  $\pi$ - $\pi$  stacking,  $\text{CH}\cdots\pi$  interaction, anion –  $\pi$  interaction, halogen bond (XB), chalcogen bond (ChB) and others [2]. Less studied is the combination of different non-covalent interactions. For example, donors of non-covalent interactions containing simultaneously sources of halogen and chalcogen bonds [3].

In our work, we proposed an approach to the synthesis of combined donors of non-covalent interactions using previously prepared diaryliodonium salts based on 1,4-diodotetrafluorobenzene. In our work, we found optimized conditions of reaction between diaryliodonium salts and potassium thiocyanate. Next, we prepared compounds **2** in reactions with different nucleophiles as  $\text{SCN}^-$ ,  $\text{NO}_2^-$ ,  $\text{N}_3^-$  and etc.

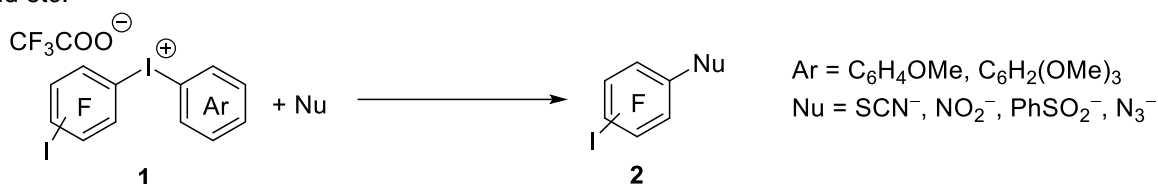

**Scheme 1.** Synthesis of combined donors of non-covalent interactions.

For some compounds, their crystal structure was determined using X-ray diffraction analysis (Fig. 1).

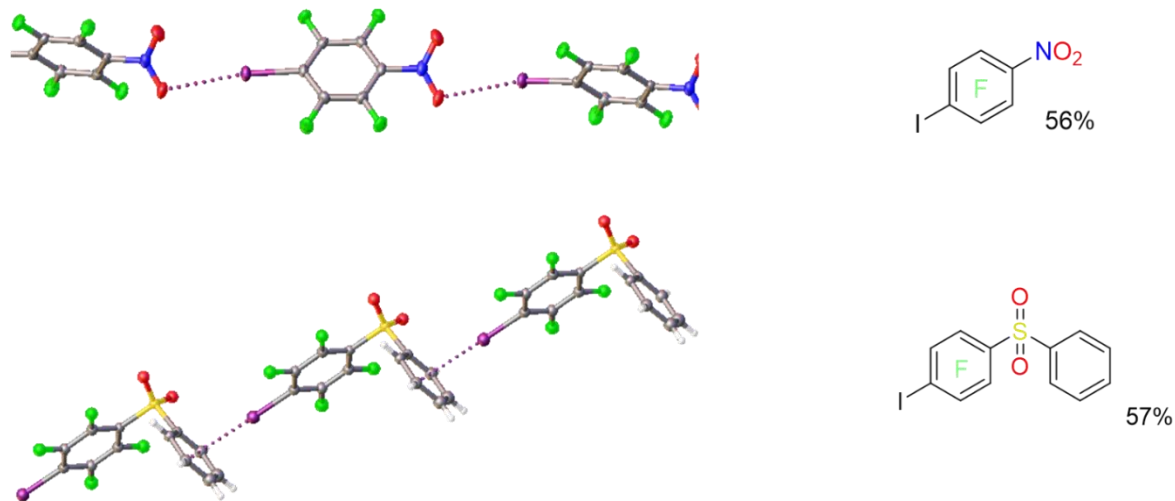

**Figure 1.** Molecular structures of the obtained compounds.

## References

- [1] *Chem. Rev.* **2000**, 100(1), 143-168
- [2] *Chem. Rev.* **2016**, 116(5), 2775-2825
- [3] *Cryst. Growth Des.* **2023**, 23(4), 2661–2674

## Acknowledgements

This work was supported by the Russian Science Foundation (project No 23-73-10091).



# CALCIUM CARBIDE AS A SOLID ACETYLENE ANALOGUE IN ORGANIC SYNTHESIS

*Ledovskaya M.S.,<sup>1</sup> Voronin V.V.<sup>1</sup>*

<sup>1</sup> St. Petersburg State University, St. Petersburg, Russia  
[m.s.ledovskaya@spbu.ru](mailto:m.s.ledovskaya@spbu.ru)

Calcium carbide is a versatile reagent for organic synthesis. Reacting with water, it gives acetylene; and a wide variety of synthetic procedures is based on this chemical property of calcium carbide [1]. In this way, a range of substituted alkynes and alkenes, pyrroles, pyrazoles, triazoles, pyridines, pyridazines, and other heterocyclic compounds were successfully synthesized [1].

Our researches included an application of calcium carbide in the synthesis of five- and six-membered heterocycles and some valuable building blocks with double or triple carbon-carbon bond. In particular, the use of calcium carbide – water (or D<sub>2</sub>O) mixture for acetylene and dideuteroacetylene generation in two-chamber reactor (Scheme 1, top and middle line) is a convenient synthetic path to a range of pyrazoles [2], triazoles [3], isoxazoles [4], pyridines [5], 3,6-disubstituted pyridazines [3,6] and their D<sub>2</sub>-labeled derivatives. Reacting with alcohols, thiols or nitrogen compounds, CaC<sub>2</sub>-H<sub>2</sub>O(D<sub>2</sub>O) mixture transforms to vinyl derivatives and their D<sub>3</sub>-labeled analogues (Scheme 1, left part) [7]. Calcium carbide-<sup>13</sup>C<sub>2</sub> can be applied as a source of <sup>13</sup>C<sub>2</sub>-acetylene or <sup>13</sup>C<sub>2</sub>D<sub>2</sub> in chemical reactions. So, Ca<sup>13</sup>C<sub>2</sub> was used in the synthesis of <sup>13</sup>C<sub>2</sub>-vinyl derivatives [8], and 4,5-<sup>13</sup>C<sub>2</sub>-labeled triazoles [9], isoxazoles [9], pyridazines [8,9] and 4,5-<sup>13</sup>C<sub>2</sub>- or 4,5-D<sub>2</sub>-4,5-<sup>13</sup>C<sub>2</sub>-pyridines [5].

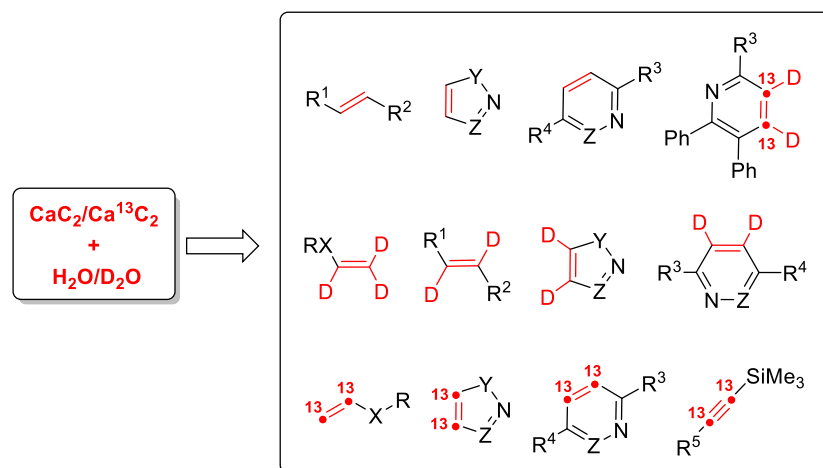

X = O, S, N; Y = O, NH, NAr, NAlk; Z = N, CAr, CAIk

**Scheme 1.** Carbide chemistry in our work.

## References

- [1] (a) *Tetrahedron* **2023**, *149*, 133720; (b) *Synthesis* **2022**, *54*, 999; (c) *Eur. J. Org. Chem.* **2021**, *2021*, 43.
- [2] *J. Org. Chem.* **2018**, *83*, 3819.
- [3] *Eur. J. Org. Chem.* **2021**, *2021*, 5640.
- [4] *Org. Chem. Front.* **2018**, *5*, 226.
- [5] *Chem. Asian J.* **2023**, e202300781.
- [6] *Chem. Asian J.* **2021**, *16*, 2286.
- [7] (a) *Org. Chem. Front.* **2020**, *7*, 1334; (b) *Synthesis* **2019**, *51*, 3001.
- [8] *Org. Chem. Front.* **2020**, *7*, 638.
- [9] *Chin. J. Chem.* **2023**, *41*, 2810.

## Acknowledgements

This work was supported by the Russian Science Foundation and Saint Petersburg Science Foundation (project No 24-23-20144).

# CHEMO- AND DIASTEREOSELECTIVE ENTRY INTO ALL-CARBON $\alpha$ -QUATERNARY ALDEHYDES VIA C-C INSERTION OF 4-DIAZOISOQUINOLIN-3-ONES INTO C-CHO BONDS

*Levashova E. Yu.*<sup>1</sup>, *Adamchik M.A.*<sup>1</sup>, *Dar'in D.V.*<sup>1</sup>

<sup>1</sup> St. Petersburg State University, St. Petersburg, Russia

PhD student

[levashovaekaterinayu@gmail.com](mailto:levashovaekaterinayu@gmail.com)

1,4-Dihydro-3(2*H*)-isoquinolone (1,4-DHIQ) core is a privileged structural motif represented in many biologically active compounds and approved pharmaceuticals, therefore the development of straightforward and efficient synthetic routes to drug-like compounds bearing 1,4-DHIQ scaffold is of great importance. Taking into the account the wide range of synthetic transformations that diazo compounds are capable of undergoing, 4-diazo-1,4-dihydroisoquinolin-3(2*H*)-ones not unexpectedly have received considerable attention as versatile heterocyclic building blocks for assembling various 1,4-DHIQ derivatives.

In this study we have investigated the  $\text{BF}_3$ -promoted reaction of 4-diazo-1,4-dihydroisoquinolin-3(2*H*)-ones with aldehydes. The corresponding reaction between diazo reagents and aldehydes represents a valuable method for the synthesis of either ketones or one-carbon homologated aldehydes, formation of which proceeds via a two-step mechanism involving carbonyl 1,2-addition of the diazo compounds, followed by a 1,2-H shift (formal C-H bond insertion) or 1,2-carbon shift (formal C-C bond insertion), respectively. Directing the reaction along the latter pathway is considered to be challenging due to the competing more favorable C-H insertion process, hence utilization of the C-C insertion reaction as a synthetic method has been scarcely exemplified [1]. However, in our case  $\text{BF}_3$ -promoted reaction of 4-diazo-1,4-dihydroisoquinolin-3(2*H*)-ones with aldehydes proceeded chemoselectively as the formal C-C insertion process delivering exclusively diastereomerically pure homologated aldehydes bearing a medicinally important 1,4-DHIQ core and an all-carbon  $\alpha$ -quaternary center [2]. Though being sensitive to electronic and steric factors present in starting compounds, the reaction tolerated a wide range of functionalities in both the aldehyde and the diazo partner, thus allowing for a broad structural diversity of products. The synthetic value of the method developed has been illustrated by some transformations of the formyl moiety, showcasing the feasible utilization of the homologated aldehydes obtained as promising precursors in the medicinal chemistry pursuits.

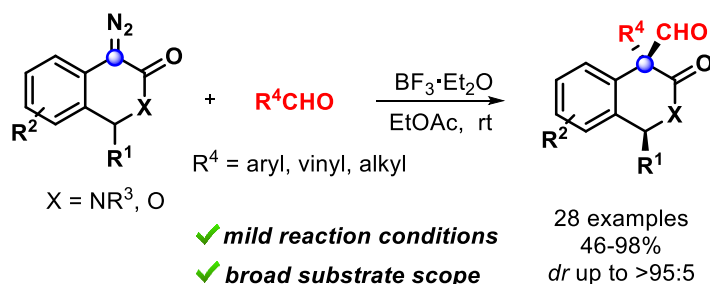

**Scheme 1.** The formal insertion of 4-diazo-3(2*H*)-isoquinolones and 4-diazoisochroman-3-one into the C-CHO bonds of aldehydes.

## References

- [1] *Tetrahedron* **2017**, *73*, 6815-6829  
[2] *J. Org. Chem.* **2023**, *88*, 11217-11226

## Acknowledgements

This work was supported by the Russian Science Foundation (project No 20-13-00024).

# ARCHITECTURE MODIFICATION OF HOVEYDA-GRUBBS TYPE RUTHENIUM CATALYSTS: A COMBINATION OF EFFICIENCY AND STABILITY IN THE OLEFINS METATESIS REACTION

*Logvinenko N.A.<sup>1</sup>, Volchkov N.S.<sup>1</sup>, Antonova A.S.<sup>1</sup>, Vasilyev K.A.<sup>1</sup>, Zubkov F.I.<sup>1</sup>*

<sup>1</sup> RUDN University, Moscow, Russia

Student

[n.a.log291003@gmail.com](mailto:n.a.log291003@gmail.com)

The formation of carbon-carbon bonds is one of the fundamental type of reactions in the field of synthetic organic chemistry. The discovery of catalyzed olefin metathesis has simplified the synthesis of pharmaceuticals and paved the way for the production of new materials from unclaimed petroleum by-products.

Ruthenium benzylidene complexes have proven to be effective catalysts for various types of olefin metathesis reactions. Previously, our research group demonstrated the high potential for expanding the chelate cycle from five to six members. This study is aimed at the synthesis and study of the catalytic properties of Hoveyda-Grubbs type catalysts containing a tridentate benzylidene ligand (Scheme 1).

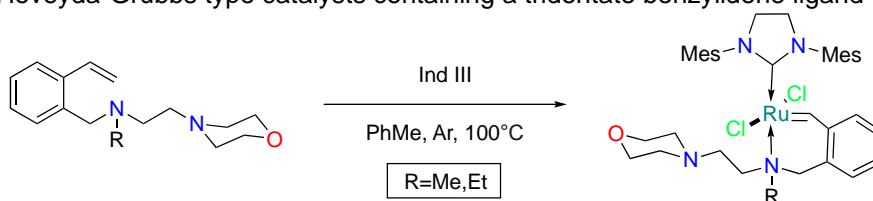

**Scheme 1.** Preparation of target complexes.

It was found that the described catalysts exhibit catalytic activity at elevated temperatures in low catalytic quantities (Scheme 2).

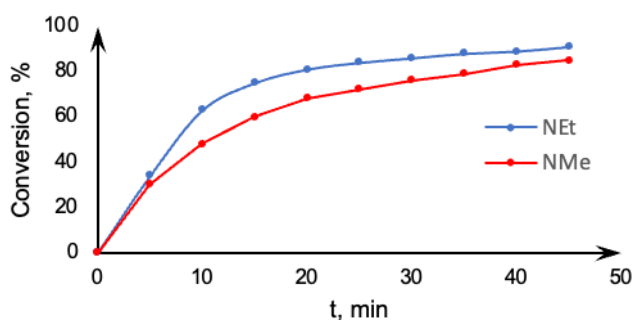
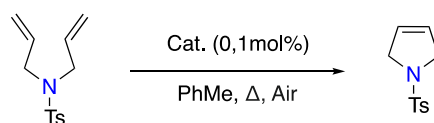

**Scheme 2.** An example of a model reaction and the dependence of conversion on time.

It was also surprising that catalysis can also occur in alcohol solutions, such conditions are unsuitable for catalysis of most known complexes of this type.

In this way, it was possible to synthesize complexes that combine efficiency and increased stability to aggressive environments, for example, methanol solutions.

IN SITU GENERATION OF ACYL(1,3-BENZOTHAZOL-2-YL)KETENES:  
THERMOLYSIS OF PYRROLO[2,1-c][1,4]BENZOTHAZINE-1,2,4-TRIONES

*Lystsova E.A., Maslivets A.N., Khramtsova E.E.*

Perm State University, Perm, Russia

PhD student

[liscova\\_ea@mail.ru](mailto:liscova_ea@mail.ru)

Acyl(imido)ketenes (AIK) are highly reactive compounds suitable for the development of diversity-oriented synthetic approaches to drug-like molecules [1]. 1*H*-Pyrrole-2,3-diones fused at [e]-side (FPDs) are ready substrates for the generation of AIK under thermolysis conditions and the production of new heterocyclic molecules [1].

We previously reported thermolytic transformations of FPDs, as a result of which the elimination of one CO molecule and the formation of the corresponding AIK were observed (a classic pathway of thermolysis of FPDs) (Scheme 1) [1].

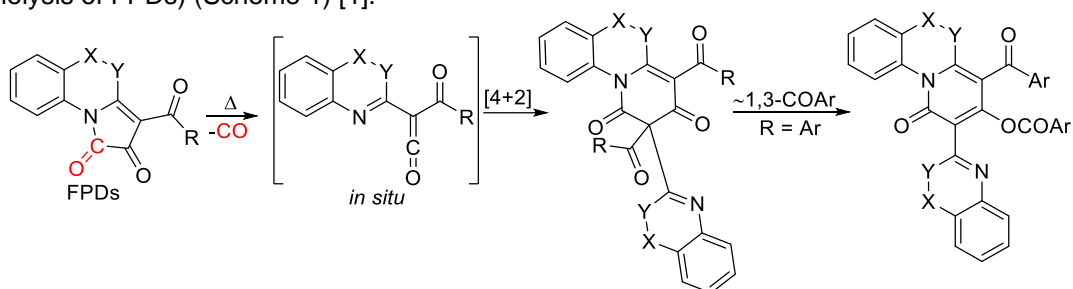

**Scheme 1.** A classic pathway of thermolysis of FPDs.

Our study of the thermolysis of sulfur-containing FPDs, pyrrolobenzothiazinetriones (PBTs) **1** and pyrrolobenzothiazolodiones (PDs) **2**, led to unexpected results [2]. The thermolysis of PBTs **1** followed a new transformation pattern – through double decarbonylation of the substrate, leading to the formation of AIK **3** and further pharmaceutically interesting pyrido[2,1-b]benzothiazol-1-ones **4** (Scheme 2) [2]. At the same time, the thermolysis of PDs **2** was accompanied by a mass loss exceeding the calculated mass loss during one CO elimination according to simultaneous thermal analysis; the reaction was not selective; the yield of the target product **4** was negligible (Scheme 2) [2].

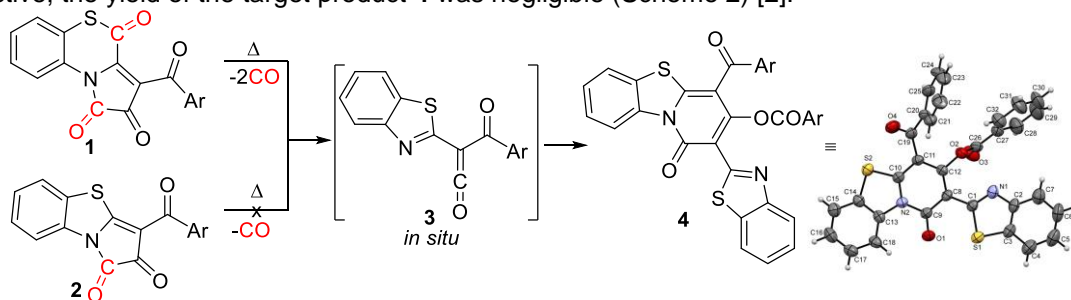

**Scheme 2.** The thermolysis of PBTs **1** and PDs **2**.

The study was accompanied by DFT calculations [2]. The structure and purity of the products were confirmed by single crystal X-ray analysis, IR and NMR spectroscopy (<sup>1</sup>H, <sup>19</sup>F, <sup>13</sup>C NMR, solid-state (ssNMR) and cryoprobe NMR techniques), thin-layer chromatography, HPLC-UV and elemental analysis.

## References

- [1] *Symmetry* **2021**, *13*, 1509  
[2] *Molecules* **2023**, *28*, 5495

## Acknowledgements

This research was funded by the Ministry of Science and Higher Education of the Russian Federation (FSNF-2023-0004), Russian Foundation for Basic Research (project 20-43-596008), and the government of Perm Krai.

## 5-SUBSTITUTED *N*<sup>4</sup>-ALKYLCYTIDINES AS PROMISING INHIBITORS WITH A WIDE SPECTRUM OF BIOLOGICAL ACTIVITY

*Makarov D.A.*<sup>1</sup>, *Jasko M.V.*<sup>1</sup>, *Karpenko I. L.*<sup>1</sup>, *Efremenkova O.V.*<sup>2</sup>, *Vasilyeva B. F.*<sup>2</sup>, *Avdanina D. A.*<sup>3</sup>, *Zhgun A. A.*<sup>3</sup>, *Kochetkov S. N.*<sup>1</sup>, *Alexandrova L. A.*<sup>1</sup>

<sup>1</sup> Engelhardt Institute of Molecular Biology RAS, Moscow, Russia

<sup>2</sup> Gause Institute of New Antibiotics RAMS, Moscow, Russia

<sup>3</sup> Research Center of Biotechnology RAS, Moscow, Russia

Postgraduate

[dmitmakarov\\_97@mail.ru](mailto:dmitmakarov_97@mail.ru)

Nowadays the problem of making anti-infective drugs is complicated by the emergence of new resistant strains, against which standard therapy schemes are inefficient. Yet the development of new classes of antibiotics has lagged far behind the growing need for such drugs. The continued emergence of drug-resistance to existing antibacterial agents represents a severe and ongoing public health concern. Evidently, there is an urgent need of new antibacterial drugs, which act on new targets and which are active against resistant strains [1].

Previously, a series of *N*<sup>4</sup>-alkyl-2'-deoxycytidine and cytidine analogues obtained in our laboratory has demonstrated *in vitro* inhibitory properties towards some of Gram-positive bacteria including drug-resistant strains as well as filamentous fungi, isolated from the paintings in the halls of Ancient Russian painting of the State Tretyakov Gallery, Russia, Moscow [2-4]. Moreover, it has been shown that the activity of these compounds fundamentally depends on the presence of a substituent at the C5 position of a pyrimidine base [4]. In current work, in order to further study the effect of structure on biological activity a series of *N*<sup>4</sup>-alkylcytidines with various substituents at the C5 position of cytosine residue were obtained (figure 1).

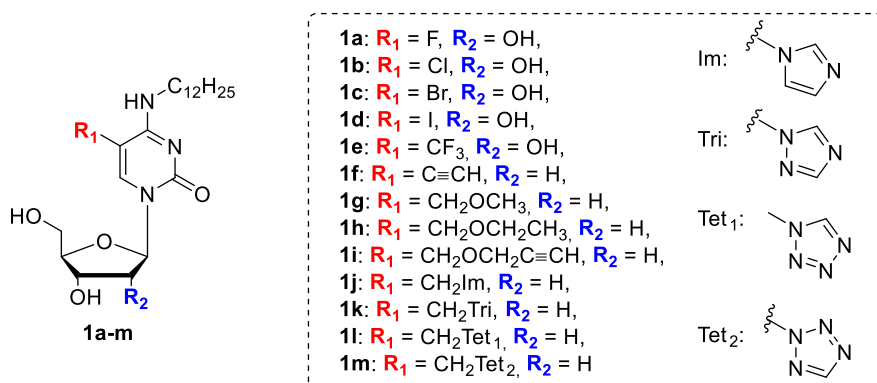

**Figure 1.** Synthesized *N*<sup>4</sup>-alkylcytidines with antibacterial and antifungal activity.

The antibacterial effect of the obtained compounds was studied by their ability to inhibit *in vitro* the growth of a number of microorganisms: 5 gram-positive and 2 gram-negative bacteria, including drug-resistant strains of *Staphylococcus aureus* and *Mycobacterium smegmatis*. The synthesized *N*<sup>4</sup>-alkyl derivatives of nucleosides effectively inhibited the growth of gram-positive bacteria, but did not affect gram-negative bacteria. Some of these derivatives also showed antifungal activity.

### References

- [1] *J. Antibiot.* **2023**, 76, 431-473
- [2] *Eur. J. Med. Chem.* **2021**, 113212
- [3] *New J. Chem.* **2022**, 46, 5614–5626
- [4] *Int. J. Mol. Sci.* **2024**, 25(5), 3053

### Acknowledgements

This work was supported by the Russian Science Foundation (Grant number: 23-14-00106).

# ALLOSTERIC DESTABILIZATION OF THE RIBOSOMAL PEPTIDYL TRANSFERASE CENTER: A MOLECULAR DYNAMICS STUDY

*Makarova T.M.*<sup>1</sup>

<sup>1</sup> South Ural State University, Chelyabinsk, Russia

Senior researcher, PhD

[makarovatm@susu.ru](mailto:makarovatm@susu.ru)

The ribosome is a huge concerted molecular machine which primary function is a protein synthesis by the peptidyltransferase reaction (PTR) between a nascent peptide in the P site and a new aminoacid on a tRNA in the A site in the peptidyltransferase center (PTC). This reaction may be regulated or affected by antibiotics in cooperation with nascent peptides, remote mutations or modifications or other allosteric factors.

The MD simulations of the 70S E coli ribosome enabled to obtain the pre-reactional structure of the PTC, which slightly differed from those observed in the Cryo-EM data. First, a hydrogen bond between C2063 nucleobase and terminal A76 of the P-tRNA (Fig. 1) is to facilitate a proton transfer from 2O' atom to 3O'. This transfer is crucial for the PTR and, according to the pH dependance picture, is to be catalyzed [1], but in the Cryo-EM structure only water molecules were proposed to carry out this catalysis [2]. Second, hydrogen bonds of the nascent peptide C-terminal carboxyl group with U2585 and U2506 that also would alleviate the PTR are originally observed in the MD simulation.

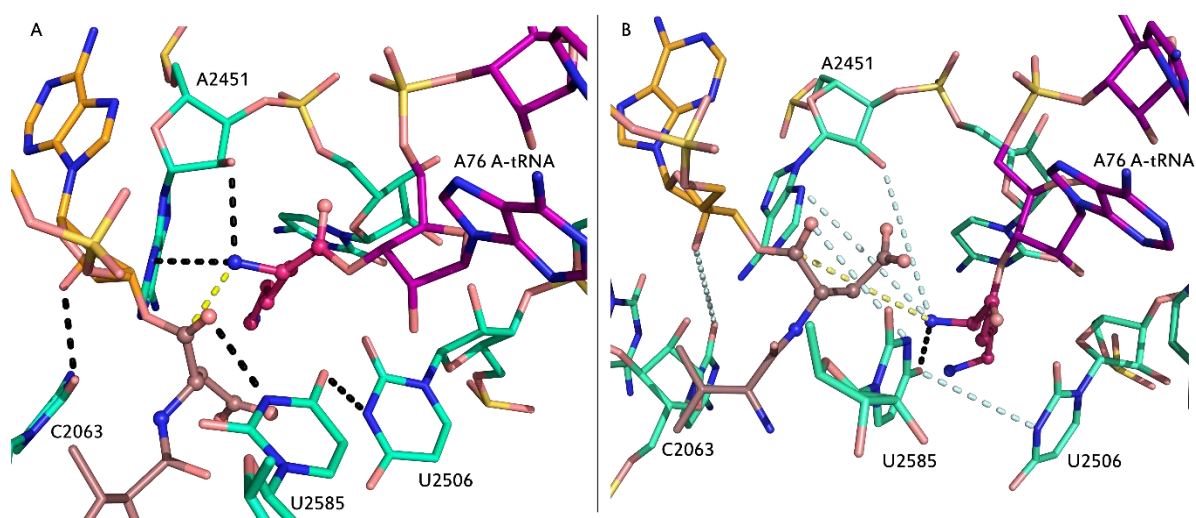

**Figure 1.** Stable (A) and distorted (B) pre-reactional state of the PTC. Black dotted lines depict stable hydrogen bonds, while palecyan ones denote dissociated H-bonds in the distorted state.

This pre-reactional state of the PTC appeared to be unstable during the MD simulations. However, a thorough optimization protocol alternated with short MD simulations provided stabilization of the newly found pre-reactional state. The PTC state was in tight coordination with the A-tRNA arrangement, and the latter was sensible to the A-site finder (ASF) position: formation of the stacking interaction between A896 of the ASF and the A-tRNA was able to pull the A-tRNA out of the pre-reactional interactions. To maintain the pre-reactional PTC structure, it was necessary for A896 to form hydrogen bonds with the very stem of the ASF. This is in line with the experimental fact, that the ASF cleavage does not damage the PTR, but affects frameshifting rate, so interactions with the ASF are required only for the A-tRNA accommodation previous to the PTR.

## References

- [1] *Mol. Cell* **2005**, 20(3), 437-448
- [2] *Nat. Struct. Mol. Biol.* **2014**, 21(9), 787-793

## Acknowledgements

All the MD simulations were performed using the “Lomonosov-II” supercomputer at Lomonosov Moscow State University.

## CATALYST FOR SELECTIVE OXIDATION OF PROPYLENE AND AMMONIA

*Bodrov A.S.<sup>1</sup>, Makeev M.A.<sup>2</sup>, Ushakov A.V.<sup>3</sup>, Burashnikova M.M.<sup>4</sup>*

<sup>1</sup> Federal State Budgetary Educational Institution of Higher Education "Saratov National Research State University", Russia, graduate student

<sup>2</sup> National University of Oil and Gas «Gubkin University», Russia, student

<sup>3</sup> Federal State Budgetary Educational Institution of Higher Education "Saratov National Research State University", Russia, assistant professor

<sup>4</sup> Federal State Budgetary Educational Institution of Higher Education "Saratov National Research State University", Russia, professor

[foxsonclub1@mail.ru](mailto:foxsonclub1@mail.ru)

The selective conversion of propylene in oxidative ammonolysis is aimed at producing acrylic acid nitrile and largely depends on the composition and properties of the multicomponent catalyst.

The process of propylene ammoxidation is based on a reaction occurring in a fluidized bed of a catalyst with the parallel formation of hydrocyanic acid and acetonitrile. By-products include acrolein, acetaldehyde and acetone. To reduce the formation of by-products that complicate the purification of acrylonitrile, ammonia is supplied in a slight excess. When propylene conversion is more than 90%, the optimal molar ratio of ammonia to propylene is in the range from 0.9:1 to 1.05:1.

The ratio of the resulting target and by-products is determined by the conditions of the process of joint oxidation of propylene and ammonia, as well as the state of the surface of the catalyst operating in a fluidized bed at temperature of 420 - 450 ° C and pressure of 0.149 - 0.181 MPa.

The mechanism of oxidative ammonolysis of olefins includes the abstraction of a hydrogen atom from the methyl group under the action of the catalyst, the formation of an adsorbed allylic complex, which, by adding oxygen, is converted into acrolein; the latter, when reacting with ammonia, forms acrylonitrile. And each act of this mechanism provides for the presence of a certain active center on the surface of the catalyst, which is formed on silicon oxide used as a carrier. The fundamental is the formation of metal oxide systems that generate oxygen for the ammoxidation of the starting reagents as a result of their redox transformation.

In this work, physicochemical studies were carried out on a multicomponent catalytic system containing molybdenum, bismuth, iron, cerium, nickel, magnesium and cesium, obtained by impregnating a carrier (silica gel) with aqueous solutions of initial metal salts.

The study of the surface condition was carried out using a Quantachrome NOVA 1200e gas sorption analyzer for nitrogen adsorption. The Barrett-Joyner-Halenda (BJH) method was used to determine the pore size distribution. The Brunauer-Emmet-Teller (BET) method is used to measure the surface area of solid materials.

It has been shown that with a specific surface area of 44 m<sup>2</sup>/g, the pore volume of 0.180 cm<sup>3</sup>/g is characterized by pores of 30-400 Å with a significant number of pores from 30 to 75 Å.

X-ray phase analysis was carried out using a multifunctional X-ray diffractometer DRON-8T. To record diffraction patterns, CuK $\alpha$  radiation, a parabolic Goebel mirror, and a Mythen 2R1D position-sensitive detector with a resolution of 0.0144° were used. Registration was carried out point by point, with a step of 0.2°, in the angle range from 10 to 80°.

X-ray phase analysis of the catalyst indicates the presence of the main phases: cerium(III) molybdate and a solid solution of nickel(II) and magnesium molybdates. Impurity phases are bismuth ( $\gamma$ -Bi<sub>2</sub>MoO<sub>6</sub>) and iron (III) molybdates, bismuth hydroxide-molybdate hydrate BiMo<sub>2</sub>O<sub>7</sub>(OH)(H<sub>2</sub>O)<sub>2</sub>.

Analysis of the morphology indicates predominantly smooth, spherical particles with a diameter in the range of 5-50  $\mu$ m. Elemental composition mapping shows that the catalyst particles operating in the process of propylene ammoxidation have protrusions in which silicon, oxygen, molybdenum and iron are concentrated. On the chip of a destroyed particle, the iron content is increased, the silicon and oxygen content is reduced.

The activity of this catalyst was studied in the process of ammonolysis of propylene in a laboratory flow reactor of a fluidized bed of the catalyst with the possibility of adjusting the gas flow and pressure in the reactor. Analysis of the starting substances, liquid and gaseous products of propylene ammoxidation was carried out by chromatographic method.

It was found that the catalyst provides a total propylene conversion of up to 96-98%, with a yield of acrylic acid nitrile of 77 wt.%, hydrocyanic acid and acetonitrile of 5.5% and 2.5 wt.%, respectively.

### Acknowledgements

Initiative

# TRIAZOLATED CALIX[4]SEMITUBES FEATURING STERICALLY HINDERED GROUPS AND ADDITIONAL FUNCTIONAL UNITS

*Malakhova M.A.*<sup>1</sup>, *Gorbunov A.N.*<sup>1</sup>

<sup>1</sup> Moscow State University, Moscow, Russia

PhD student

[malakhova.mari@list.ru](mailto:malakhova.mari@list.ru)

Molecular platforms of calixarenes (cyclic phenol tetramers linked by methylene bridges) provide opportunities for combination and spatial preorganization of several functional groups of different nature. The versatility of calixarenes as molecular platforms is due to the availability of polyphenolic macrocycles themselves and well-developed approaches to the modification of phenolic hydroxyl groups and/or aromatic p-positions to them. The developing of methods for obtaining and studying the properties of new supramolecular systems based on calixarene macrocycles could contribute to creation of controlled molecular switches.

The enrichment of calixarene chemistry with the copper(I)-catalyzed azide–alkyne cycloaddition (CuAAC) approach has made available macrocycles having several 1,4-disubstituted 1,2,3-triazole groups attached to a common platform, which appeared to be efficient multidentate ligands for binding and sensing transition metal cations. Moreover, previously triazolated calix[4]semitubes consisting of two or three calixarene macrocycles were synthesized by two-fold CuAAC approach [1,2] and the peculiarities of the Ag<sup>+</sup> cation binding by them was studied [3]. In this work, the impact of sterically hindered groups in the p-positions of aromatic calixarene units was assessed on both the assembling of bis(calixarene) semitubes and the ability of these compounds to form silver complexes.

Firstly, 1,3-alternate calix[4]arenes were prepared, having t-butyl, bromine or 1-adamantyl groups in the p-positions of two or all four aromatic units of the macrocycles and pairs of propargyl or 2-azidoethyl groups alternating with n-propyl groups at the phenol oxygen atoms.

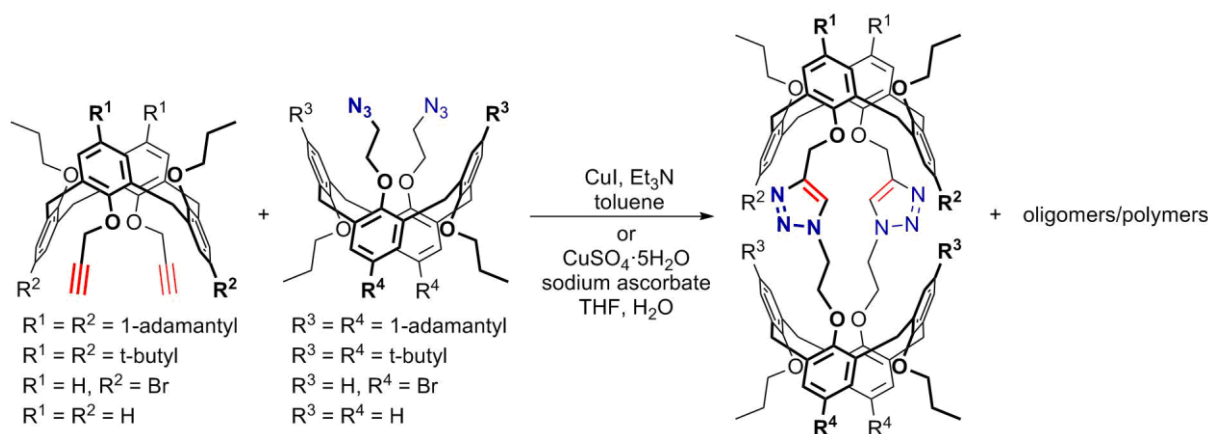

**Figure 1.** Two-fold CuAAC reactions between propargylated and 2-azidoethylated calix[4]arenes.

Then different combinations of calixarene azides/acetylenes were tested under the CuAAC conditions and several bis(calixarene) semitubes with bulky substituents, which provided additional shielding of triazole binding site, were synthesized. And, finally, the receptor properties of the triazolated semitubes towards Ag<sup>+</sup> cations were studied and the dependence of the binding modes from the structure features was determined using NMR and preliminary X-ray data.

## References

- [1] *Org. Chem. Front.* **2021**, 8, 3853–3866
- [2] *Org. Chem. Front.* **2022**, 9(11), 3084-3092
- [3] *Org. Biomol. Chem.* **2022**, 20(41), 8092-8103

## Acknowledgements

This work was supported by the Russian Science Foundation (project No 22-73-00052).



# CREATION AND CHARACTERISTICS OF NANOCARRIERS FOR THE DELIVERY OF DRUGS AND ANTIDOTES

*Mansurova E.E.*<sup>1,2</sup>, *Chudinov N.Yu.*<sup>1</sup>, *Shulaeva M.M.*<sup>2</sup>, *Fazleeva R.R.*<sup>2</sup>, *Voloshina A.D.*<sup>2</sup>, *Lyubina A.P.*<sup>2</sup>, *Nizameev I.R.*<sup>3</sup>, *Kadirov M.K.*<sup>2</sup>, *Ziganshina A.Yu.*<sup>2</sup>, *Semenov V.E.*<sup>2</sup>, *Antipin I.S.*<sup>1</sup>

<sup>1</sup> Alexander Butlerov Institute of Chemistry, Kazan Federal University, Russia

<sup>2</sup> A. E. Arbuzov Institute of Organic and Physical Chemistry, FRC Kazan Scientific Center, Russian Academy of Sciences, Russia

<sup>3</sup> Kazan National Research Technical University named after A. N. Tupolev – KAI, Russia  
Graduate student

[elinamans17012@gmail.com](mailto:elinamans17012@gmail.com)

The development of nanocarriers based on various biocompatible materials is a topic of current research in medicinal chemistry. Improving the effectiveness of therapy requires the use of multifunctional systems that can be spontaneously formed and precisely distribute medication, selectively detect lesions, and release the medication at a controlled rate. [1] Pharmaceuticals have a greater therapeutic effect when they are delivered using nanocarriers containing physiologically active, receptor-specific fragments.

This paper presents three novel types of polymer nanocarriers. Delivering an antidote for organophosphate poisoning is the goal of the first nanocarrier. It consists of histidine resorcinarene molecules bonded together by boronate linkages (Scheme 1A). This nanocarrier has been shown to be able to hydrolyze acetylcholine (ACh), by attaching to it and functioning as an acetylcholinesterase (AChE). During the hydrolysis process, acetic acid is produced, which attacks the boronate bonds of the nanocarrier, leading to its degradation and the release of the antidote.

The second and third samples are glutathione-sensitive nanocarriers, obtained by microemulsion polymerization of 5-(3,6-dimethyluracil)pentyl acrylate with compounds containing disulfide bonds (Figure 1B). In the dispersed phase, containing diallyl disulfide or *N,N'*-bis-acryloylcystamine in DMSO, doxorubicin (DOX), a chemotherapeutic agent, and meso-tetrakis(*N*-methylpyridinium-4)-porphyrin (TMPyP), a photosensitizer, are encapsulated to form hydrophobic nuclei. DOX and TMPyP work together to produce reactive oxygen species that kill cancer cells, while the uracil groups on the nanocarriers surface help to increase the penetration of drugs into cancer cells. The thiol-disulfide exchange between the disulfide bonds in the nanocarriers and intracellular glutathione in cancer cells causes the degradation of the nanocarriers and the release of the drugs. The effectiveness of generating reactive oxygen species under irradiation has also been studied for these carriers with encapsulated photosensitizers.

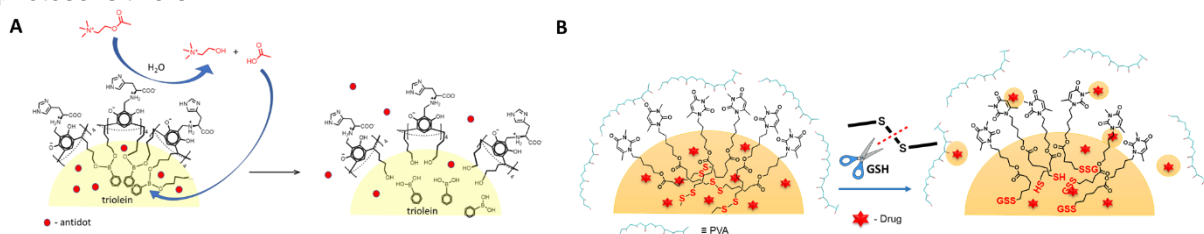

**Scheme 1.** The scheme of degradation of nanocarriers.

## References

- [1] *Artif. Cells Nanomed. Biotechnol.* **2018**, *46*, 295-305
- [2] *Bioconjug. Chem.* **2016**, *27*, 2225–2238

## Acknowledgements

This work was supported by the Russian Science Foundation (project No 23-23-00381).

# STEPWISE HYDROLYSIS OF N-ALKYLATED 3,4-DIHYDROPYRIMIDO[2,1-a]ISOINDOL-6(2H)-ONES

*Martyanov G.S.<sup>1</sup>, Barabanov M.A.<sup>1</sup>, Pestov A.V.<sup>1</sup>*

<sup>1</sup>I.Ya. Postovsky Institute of Organic Synthesis of the Ural Branch of the Russian Academy of Sciences, Ekaterinburg, Russia  
PhD student  
[darth\\_tomat@mail.ru](mailto:darth_tomat@mail.ru)

N-monoalkylated N-aminopropylphthalimides **3** and N-aminopropylphthalamic acids could be used like detergents and surfactants [1-2]. Moreover, some of them show interesting bioactivity [3]. However, there are no reliable and general methods for preparation of such compounds.

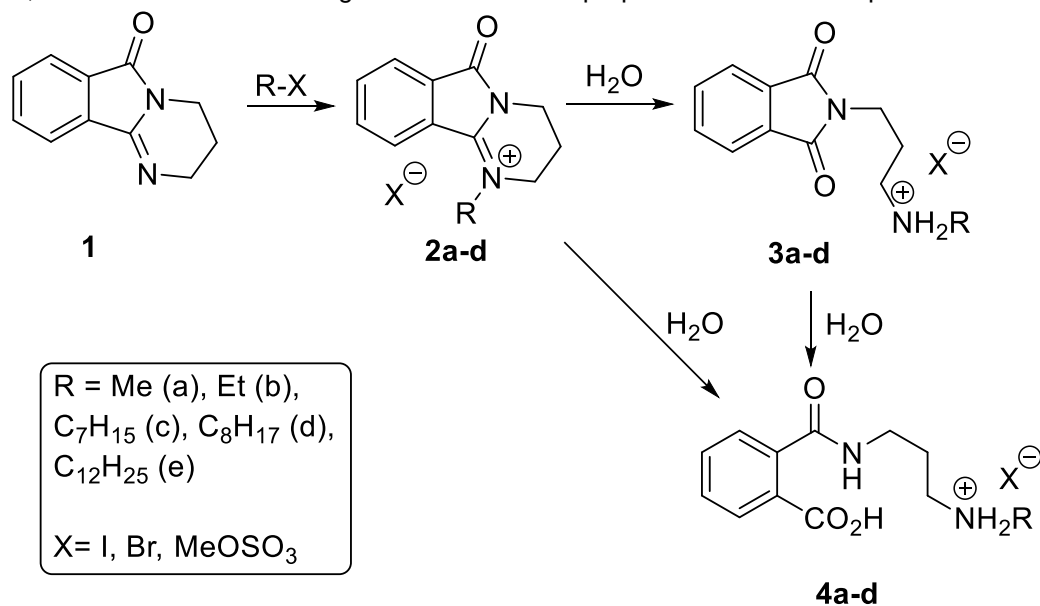

**Scheme 1.** Synthesis of phthalimides **3** and phthalamic acids **4**.

We suggest simple and elegant synthetic route which leads to both phthalimides **3** and phthalamic acids **4**.

First stage is alkylation of dihydropyrimido[2,1-a]isoindol-6(2H)-one **1** to form quaternates **2**. Reaction conditions depends on structure alkylation agent: RT and acetonitrile was used as a solvent for small molecules, and heating to 150°C without solvent – for long-chain molecules.

To obtain phthalimides **3**, quaternates **2** could be hydrolysed. Reaction require heating quaternates **2** with water in neutral or acidic organic solvent, for example acetone or acetic acid. It is interesting to notice, that long-chain quaternates **2d-e** partially hydrolyses with air moisture during storage.

Phthalamic acids **4** could be prepared both from quaternates **2** and phthalimides **3**. To obtain substances **4** an alkaline hydrolysis conditions should be used. Reaction goes when quaternates **2** or phthalimides **3** heated in water in the presence of bases like NaHCO<sub>3</sub>, Na<sub>2</sub>CO<sub>3</sub> or NaOH. After the reaction is completed, solution is acidified to form a precipitate of phthalamic acid **4**.

## References

- [1] *Pat. WO2022259193, 2022*
- [2] *Pat. JP2003171379, 2008*
- [3] *Biotechnol. Adv. 2019, 37, 177*

# INFLUENCE OF NITROSYL IRON COMPLEXES WITH AROMATIC LIGANDS ON THERAPEUTIC ENZYMATIC TARGETS

*Mazina L.M.<sup>1</sup>, Novikova V.O.<sup>1</sup>, Pokidova O.V.<sup>1</sup>, Konyukhova A.S.<sup>1,2</sup> Sanina N.A.<sup>1,2,3</sup>*

<sup>1</sup> Federal Research Center of Problems of Chemical Physics and Medicinal Chemistry of Russian Academy Sciences, Chernogolovka, Russia

<sup>2</sup> Lomonosov Moscow State University, Moscow, Russia

<sup>3</sup> Scientific and Educational Center "Medical Chemistry" in Chernogolovka, Federal State Autonomous Educational Institution of Higher Education "State University of Education", Moscow Region, Mytishchi, Russia

Postgraduate

[lmzina@icp.ac.ru](mailto:lmzina@icp.ac.ru)

Cardiovascular diseases (CVDs) are the leading cause of death worldwide. One of the main factors in their development is a disruption in the production of an important regulatory molecule, nitrogen monoxide (NO) [1]. To compensate for its lack in medical practice, exogenous NO donors are widely used in the treatment of CVDs. In this work, several promising compounds were considered, nitrosyl iron complexes (NICs) with sulfur-containing ligands, which are sources of NO that do not require additional activation for its generation. Soluble guanylate cyclase (sGC) and adenylate cyclase (AC) are direct enzymatic targets of NO-dependent signaling. As a result of their interaction, the level of important second messengers' increases: cyclic guanosine monophosphate (cGMP) and cyclic adenosine monophosphate (cAMP). Increased cGMP concentrations mediate the vasodilatory effect, and changes in cAMP levels affect heart rate, vascular resistance, and vascular contractility. Also, the intracellular concentration of cyclic nucleotides is regulated by the enzyme phosphodiesterase (PDE). Inflammation also can be an important risk factor for the development of CVDs. Correspondingly Cyclooxygenase (COX-2) may be a promising therapeutic target that should be considered.

The purpose of this work is to study the effect of NICs with aromatic ligands on enzymatic targets: AC, sGC, PDE, and COX-2. For this purpose, solutions of the complexes ( $10^{-4}$ M,  $10^{-5}$ M and  $10^{-6}$ M) were incubated with homogenates of mouse hearts (BDF1 line), and then the concentrations of cAMP and cGMP were assessed by competitive ELISA. In addition, since sGC and AC are direct targets of the action of NO, the NO-donor activity of NICs was studied according to the kinetics of nitrite accumulation using the Griess reaction. The inhibitory effect on PDE was assessed by the accumulation of inorganic phosphate as a result of a simulated enzymatic reaction. The influence on COX-2 was investigated by modeling enzymatic reaction.

The greatest effect on changes in cGMP levels was exerted by a complex with 3,4-dichlorothiophenyls at a concentration of  $10^{-4}$  M, causing its increase by 4.5 times compared to the control. The most significant change in the concentration of cAMP was caused by the complex with 4-chlorobenzenemethanethiolyl ligands – 2.7 times; its effect on sGC led to an increase in cGMP by 1.7 times. The complex with 4-methoxybenzenemethanethiolyls affected only AC ( $10^{-5}$  M): cAMP was 1.8 times higher compared to the control. Complexes with 4-acetamidothiophenyls, with 2-methoxythiophenyls, with benzenemethanethiolyls and 2-Phenylethanethiolyl showed less pronounced effects on AC and sGC. The reference compound is the thiosulfate complex of the composition  $\text{Na}_2[\text{Fe}_2(\text{S}_2\text{O}_3)_2(\text{NO})_4] \cdot 4\text{H}_2\text{O}$ ; it is the most effective NO donor among the studied NICs. It ( $10^{-6}$ M) leads to a 1.6-fold decrease in cAMP, and inhibits PDE activity completely by 100% ( $10^{-4}$ M). The remaining complexes have a less pronounced effect on the functions of PDE.

Thus, it was established that all studied complexes affect enzymatic targets. The most pronounced effect is demonstrated by NIC with 3,4-dichlorothiophenyls.

## References

[1] *Cardiology*. **2012**, 55-68

## Acknowledgements

The study was supported by the Russian Science Foundation grant No. 22-73-10049, <https://rscf.ru/project/22-73-10049/>

# SYNTHESIS OF ETHYNYL SUBSTITUTED INDOLE-PYRROLINE DYADS UNDER NICHOLAS REACTION CONDITIONS

*Melnikov V.E.<sup>1</sup>, Khmelevskaya E.A.<sup>1</sup>, Danilkina N.A.<sup>1</sup>*

<sup>1</sup>St. Petersburg State University, St. Petersburg, Russia  
[st116494@student.spbu.ru](mailto:st116494@student.spbu.ru)

The Nicholas reaction is a convenient synthetic tool for the propargylation of organic nucleophiles using stabilized  $\text{Co}_2(\text{CO})_6$ -propargyl carbocations [1]. Nevertheless, under the Nicholas reaction conditions, alternative transformations may occur without the initially suggested propargylation. We have previously shown that the dihydrofuran ring can be obtained by  $\text{BF}_3 \cdot \text{OEt}_2$ -promoted O-cyclization at the triple bond at position C3 of the indole ring [2].

The aim of this work was to test the Nicholas cyclization conditions as a convenient non-metallic method to generate five-membered N-heterocyclic structures, indole-pyrroline dyads, which are commonly found in biologically active compounds [3].

Indole-fused acyclic enediyne **3a-e** with the  $\text{NHSO}_2\text{Ar}$  functionalities at the homopropargylic position at the C3 triple bond can be easily obtained by the Sonogashira reaction. These compounds being converted to the corresponding C2- $\text{Co}_2(\text{CO})_6$ -complexes underwent  $\text{BF}_3 \cdot \text{OEt}_2$ -promoted N-cyclization at the unprotected C3-triple bond with the formation of pyrrolines **4a-e** (Scheme 1). It is noteworthy that the anticipated Nicholas cyclization did not occur. Furthermore, when free cobalt enediyne **3a** was treated with  $\text{BF}_3 \cdot \text{OEt}_2$ , the cyclization to pyrroline was not observed, and only the hydration of the C3 triple bond took place.

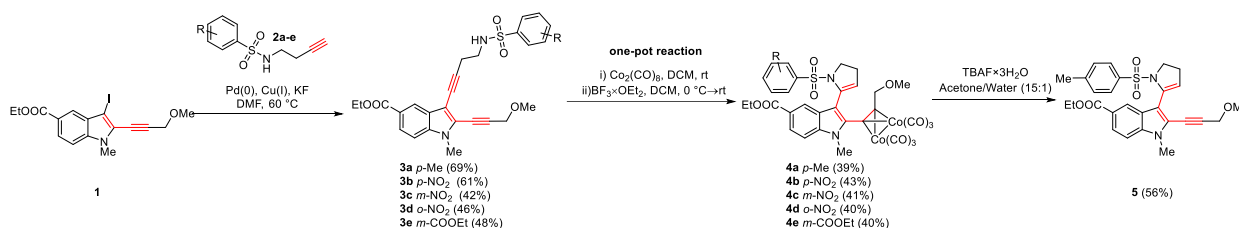

**Scheme 1.** Preparation of indole-pyrroline dyads under the Nicholas cyclization conditions.

This direction of the cyclization is probably related to the greater donor ability of the nitrogen atom in indole, compared to the S atom in benzothiophene [4], which makes the C3-triple bond more reactive towards  $\text{BF}_3$ -activation and the subsequent intramolecular nucleophilic addition of the  $\text{NHSO}_2\text{Ar}$  function.

Based on the results of this work, a small library of indole-pyrroline dyads **4a-e** with the cobalt-protected triple bond was prepared. The obtained Co-complex **4a** can be converted into the corresponding free of cobalt heterocycle **5** in a good yield.

## References

- [1] *Tetrahedron* **2002**, *58*, 4133-4170
- [2] *J. Org. Chem.* **2020**, *85*, 9001-9014
- [3] *Top. Curr. Chem.* **2021**, *379*, 34
- [4] *Synlett* **2019**, *30*, 161-166

# SYNTHESIS NEW FLUORESCENT DYES BASED ON 4,5-DIETHYNYL-1,2,3-TRIAZOLES

*Menchicov V.V.<sup>1</sup>, Govdi A. I.<sup>1</sup>*

<sup>1</sup> St. Petersburg State University, St. Petersburg, Russia  
Student, 2 years of Bachelor's degree  
[st106275@student.spbu.ru](mailto:st106275@student.spbu.ru)

1,2,3-Triazoles continue to occupy a leading position in various fields of fundamental and applied research due to their synthetic accessibility, the ability to vary the structure according to three positions of the heterocycle, as well as a wide range of biological activity [1]. In addition, it is known that 1,2,3-triazoles have fluorescent properties and can act as fluorescent dyes for biological imaging and fluorescent sensors for metal ions, organometallic compounds, etc. [1, 2]. However, there are still unresolved issues to achieve the ideal fluorescent dye or sensor, which makes research in this area very promising.

We have previously demonstrated that the 1,2,3-triazole ring can be used as a  $\pi$ -linker in the synthesis of push-pull fluorophores with high quantum yields and large Stokes shifts [3]. In this work, we have expanded the structural diversity of donor-acceptor type fluorophores (D- $\pi$ -A) and studied their photophysical properties.

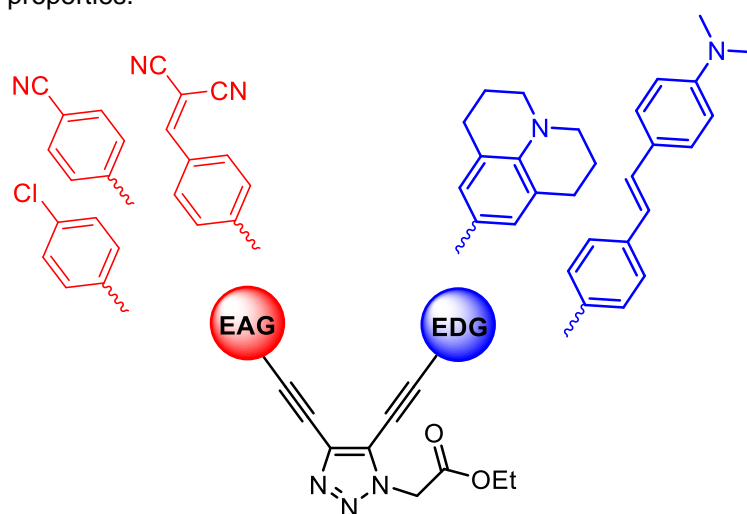

**Scheme 1.**

Emission and absorption spectra and quantum yields have been determined for the obtained compounds. Three peaks were observed in the absorption spectra in the region of 270-300 nm, 300-350 nm and 370-430 nm, which most likely correspond to the  $\pi \rightarrow \pi^*$  transition. In the emission spectra, the maxima are in the range of 540-560 nm, which corresponds to the green and yellow-green regions of the visible spectrum. In addition, we investigated the solvatochromic effects of the synthesized compounds and found that for all compounds there is a decrease in fluorescence intensity with an increase in the polarity of the solvent.

## References

- [1] *New J. Chem.* **2022**, 44, 3546-3561
- [2] *Doklady Chemistry*, **2023**, 512(1), 232-241
- [3] *Molecules* **2022**, 27, 10

## Acknowledgements

This work was supported by the Russian Science Foundation (project No 19-73-10077-П).

# SUPERCRITICAL CARBON DIOXIDE AS PROSPECTIVE MEDIUM FOR PHOTOOXIDATION PROCESSES IN ORGANIC SYNTHESIS

Merkulov V.G.,<sup>1,2</sup> Ivanova E.A.,<sup>1,2</sup> Rusakov S.P.,<sup>1,2</sup> Zharkov M.N.<sup>1</sup>

<sup>1</sup> N.D. Zelinsky Institute of Organic Chemistry of Russian Academy of Sciences, Moscow, Russia

<sup>2</sup> D. Mendeleev University of Chemical Technology of Russia, Moscow, Russia

Student

[merkulovvlad068@gmail.com](mailto:merkulovvlad068@gmail.com)

The development of oxidation methods plays a significant role in fine and industrial organic synthesis since they allow to obtain value-added products such as nitrocompounds, aldehydes, ketones etc. However, common synthetic procedures might be dangerous due to toxicity of widely used oxidative reagents like hypervalent iodine compounds, sulfur and phosphorous ylides, metal oxides, nitric acid etc. Photochemical activation allows the use of less harmful reagents as oxygen in mild reaction conditions. It worth to mention that supercritical carbon dioxide (sc-CO<sub>2</sub>) is an excellent medium for processes under consideration owing to its unique properties. Carbon dioxide has high mass and heat transfer coefficients, it is absolutely resistant to oxidants, transparent for UV and visible light irradiation, and it appears as “green” and perspective reaction medium that dissolves gases and low polar organic substances well.

In the present work, we developed the photocatalytic oxidation method of saturated alcohols with molecular oxygen in presence of organic catalyst 2-fluoranthraquinone-9,10 (2-FAQ) in sc-CO<sub>2</sub> [1]. The efficiency of the process can be controlled by fine-tuning the properties of the reaction medium (T, °C; P, MPa; d, g/cm<sup>3</sup>). Thus, we found optimal conditions for the model reaction of cyclohexanol oxidation and spread the method on a wide range of aliphatic alcohols. Based on experimental data, the plausible reaction mechanism has been proposed (see Figure 1 below).

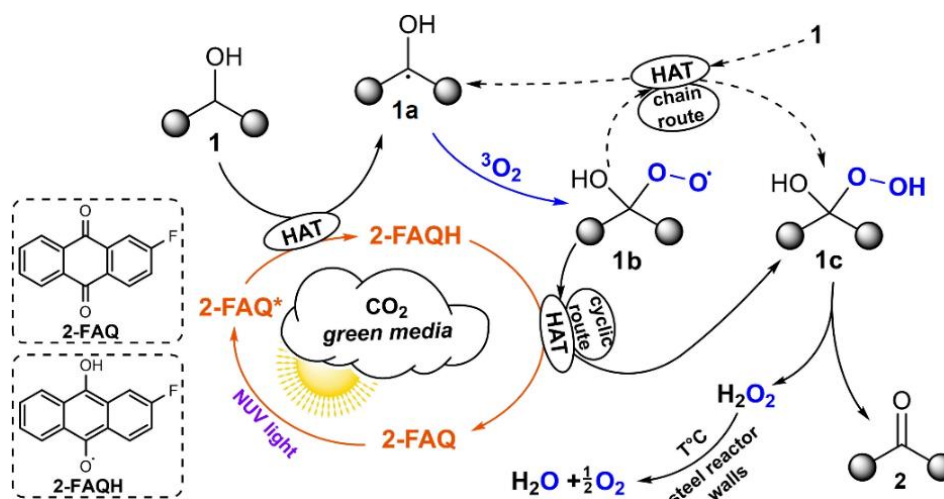

**Figure 1.** Plausible mechanism of photocatalytic alcohol oxidation in sc-CO<sub>2</sub>.

The method has been applied for oxidation of more complicated alcohols as menthol and aliphatic diols, benzylic hydrocarbons as toluene and cumene, and heteroatom containing substances. Recently it has been discovered that the oxidation of butandiol-1,4 in the proposed conditions leads to the formation of 4-hydroxybutanoic acid and  $\gamma$ -butyrolactone – commercially and synthetically valuable materials. Also, we have succeeded in a multicomponent oxidation of previously inactive diphenyl sulfide to sulfoxide and sulfone. These examples demonstrate the potential of our catalytic system for synthetic applications that deserves deeper investigation and further improvement.

## References

[1] *ChemPhotoChem*, **2024**, *8*(4), e202300233

## Acknowledgements

This work was supported by the Russian Science Foundation (project No 23-73-00071).

# QUADRUPLE REACTIVITY OF STERICALLY HINDERED *ORTHO*-DIMETHYLAMINO ARYLOXIMES IN ACIDIC MEDIA

*Meshalkin S.A.*<sup>1</sup>, *Tsybulin S.V.*<sup>1</sup>, *Tonkoglazova D.I.*<sup>1</sup>, *Antonov A.S.*<sup>2,3</sup>

<sup>1</sup> St. Petersburg State University, St. Petersburg, Russia

<sup>2</sup> University of Regensburg, Regensburg, Germany

<sup>3</sup> Ludwig Maximilian University of Munich, Munich, Germany  
Student

[stepan.a.meshalkin@gmail.com](mailto:stepan.a.meshalkin@gmail.com)

Oximes are highly prized and versatile structures with significance in medicinal and materials chemistry, along with synthetic applications. Their distinctive characteristics encompass dual nucleophilic sites at both oxygen and nitrogen, coupled with an ambiphilic carbon, rendering them promising candidates for a wide range of reactive pathways. It is well known that in acidic media oximes undergo Beckmann rearrangement leading to the formation of nitriles and amides. In this study we demonstrate the possibility to tune the reactivity of aromatic oximes bearing *ortho*-dimethylamino group to produce valuable heterocyclic scaffolds: indazoles, indoles and benzoisoxazoles (Scheme 1).

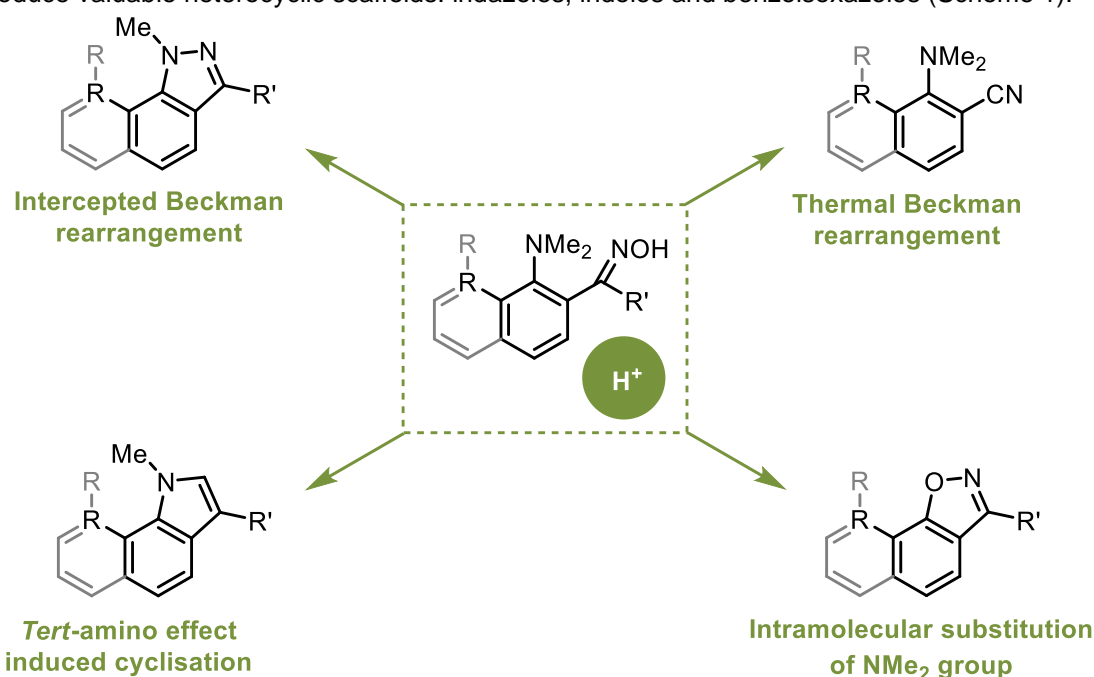

**Scheme 1.** Four ways of the transformation of sterically hindered *ortho*-dimethylamino aryloximes in acidic media: dehydration to nitriles, demethylation-assisted cyclisation in indazoles,  $NMe_2$  group substitution with the formation of isoxazoles and *tert*-amino effect induces pyrrole ring construction.

Introduction of bulky substituents to the *ortho*- or *peri*-position of dimethylamino group on the one hand facilitates formation of nitriles, but on other hand activated  $NMe_2$  group for heterocyclizations. The direction of transformation can be precisely controlled by the reaction media. Thus, utilization of  $HBF_4$  in acetone allows selective synthesis of nitriles. Transition to more nucleophilic HI in MeOH gives corresponding indazole as the only product. Heating of naphthalene-bases oximes in neat acetic acid provides selective synthesis of isoxazoles. Finally in the case of super strained naphthalene-based oximes realization of *tert*-amino effect allows moderately selective formation of indoles in alcohol media in presence of strong acids.

# DEVELOPMENT OF FAR-RED ARCHAERHODOPSIN-3-BASED FLUORESCENT GENETICALLY-ENCODED VOLTAGE INDICATORS

*Metelkina E.M.<sup>1</sup>, Nikolaev D.M.<sup>1</sup>*

<sup>1</sup> St. Petersburg State University, St. Petersburg, Russia  
Student

[metelkina.em@gmail.com](mailto:metelkina.em@gmail.com)

Genetically Encoded Voltage Indicators (GEVIs) found wide applications as molecular tools for visualization of changes in cell membrane potential. Among others, archaerhodopsin-3-based (Arch) GEVIs have proved themselves promising in molecular imaging studies. While voltage-dependent fluorescence of the wild-type Arch is extremely dim, directed evolution has allowed the researchers to obtain substantial signal enhancement [1-3]. To date, rational design approaches have not been applied for engineering of Arch-based GEVIs due to the lack of knowledge about the mechanisms that regulate fluorescence enhancement in these proteins. Here, we combined rational design and database analysis techniques to perform further optimization of GEVIs from the Archers class [4].

We elucidated key structural factors that determine bright potential-dependent fluorescence in Arch mutants. The obtained data together with the main rules for spectral tuning in rhodopsins allowed us to perform rational design of new Arch-based GEVIs from Archers class. The obtained GEVIs with  $\lambda_{max}$  in the range 640 - 648 nm are the most red-shifted GEVIs among reported by now. Obtained fluorescence quantum yields (up to 1.1%) are the largest among all previously reported Arch-based GEVIs.

## References

- [1] *PNAS* **2014**, *111*(36), 13034-13039
- [2] *Nat. Methods* **2014**, *11*(8), 825–833
- [3] *Nat. Chem. Biol.* **2018**, *14*(4), 352-360
- [4] *ACS Phys Chem Au.* **2024**, 10.1021/acspchemau.3c00073

## Acknowledgements

The study was funded by the Russian Science Foundation (RSF), grant No. 23-73-00041. The research is carried out using the equipment of the shared research facilities of HPC computing resources at Lomonosov Moscow State University.



# SYNTHESIS, STRUCTURE IN THE CRYSTALLINE PHASE AND NEW REARRANGEMENTS IN THE SERIES OF 2-ARYLHYDRAZONE THIAZOLO[3,2-*a*]PYRIMIDINE DERIVATIVES

*Mingazhetdinova D.O.*<sup>1</sup>, *Agarkov A.S.*<sup>1,2</sup>, *Nefedova A.A.*<sup>2</sup>, *Ovsyannikov A.S.*<sup>2</sup>, *Litvinov I.A.*<sup>2</sup>,  
*Solovieva S.E.*<sup>1,2</sup>, *Antipin I.S.*<sup>1,2</sup>.

<sup>1</sup> Department of Organic and Medical Chemistry, Kazan Federal University, Kazan, Russia

<sup>2</sup> Arbuzov Institute of Organic and Physical Chemistry, FRC Kazan Scientific Center,  
Russian Academy of Sciences, Kazan, Russia

Student

[doming01@mail.ru](mailto:doming01@mail.ru)

Currently, hydrazones are promising building blocks for the creation of various supramolecular architectures, since they can undergo conformational and configuration changes under the influence of external conditions [1]. Thus, from the point of view of supramolecular chemistry, the potential use of compounds containing a hydrazone functional group for the design of molecular switches, as well as for the creation of new materials, has been demonstrated [2]. This work is devoted to the synthesis (Figure 1) and study of the 2-arylhydrazone thiazolo[3,2-*a*]pyrimidine derivatives structure in the crystalline phase (Figure 2a).

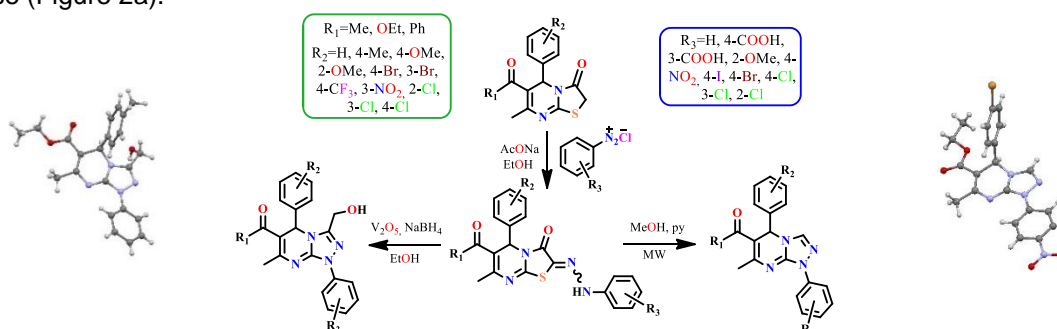

**Figure 1.** Scheme of thiazolo[3,2-*a*]pyrimidine 2-arylhydrazones synthesis [3] and further rearrangements into triazolo[4,3-*a*]pyrimidines.

It was established arylhydrazones are in *Z*-isomer form in the crystalline phase. Besides, it was showed the formation of racemic dimers and homochiral chains via non-covalent intermolecular forces (Figure 2b,c) [3-5].

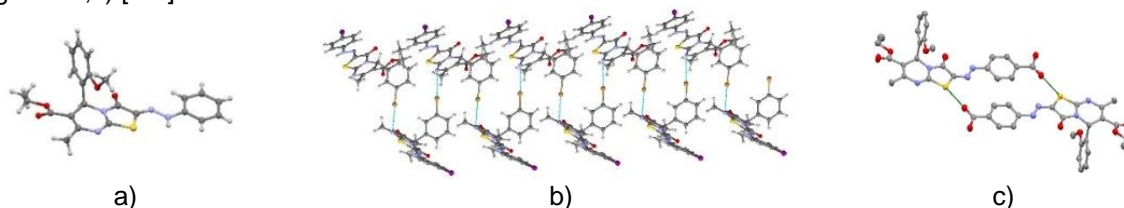

**Figure 2.** a) Geometry; b) halogen-bonded homochiral chains; c) chalcogen-bonded dimers of 2-arylhydrazone thiazolo[3,2-*a*]pyrimidine derivatives in the crystalline phase.

A new unique methods were discovered for the synthesis of triazolo[4,3-*a*]pyrimidine derivatives, by the reaction of 2-arylhydrazone thiazolo[3,2-*a*]pyrimidine derivatives with a reducing system – vanadium(V) oxide and sodium borohydride and by the reaction under microwave activation conditions.

## References

- [1] *Eur. J. Org. Chem.* **2022**, 28, e202200228
- [2] *Coord. Chem. Rev.* **2021**, 431, 213666
- [3] *Dokl. Chem.*, **2022**, 503(1), 45–50
- [4] *Int. J. Mol. Sci.* **2023**, 24, 2084
- [5] *Molecules* **2022**, 27(22), 7747

## Acknowledgements

The authors are grateful to the Assigned Spectral-Analytical Center of Shared Facilities for Study of Structure, Composition and Properties of Substances and Materials of the Federal Research Center of Kazan Scientific Center of Russian Academy of Sciences (CSF-SAC FRC KSC RAS) for technical support.

# OPTIMIZATION OF THE ANTHOCYANINS EXTRACTION FROM THE RICE "SOUTHERN NIGHT"

*Molchanov M. I.<sup>1</sup>, Zavyalova V.V.<sup>1</sup>, Slovesnova N.V.<sup>1,2</sup>, Petrov A. Yu<sup>1,2</sup>, Nikonov I. L.<sup>2,3</sup>, Galishev B.A.<sup>2</sup>, Kopchuk D.S.<sup>2,3</sup>, Grzhegorzhevskii K.V.<sup>2</sup>*

<sup>1</sup> Ural state medical academy, Yekaterinburg, Russia

<sup>2</sup> Ural federal university, Yekaterinburg, Russia

<sup>3</sup> I.Ya. Postovsky Institute of Organic Synthesis of the Ural Branch of the Russian Academy of Sciences  
Student

[mol.makar@mail.ru](mailto:mol.makar@mail.ru)

Finding the natural source of the bioactive compound is one of the key strategies for producing medicines. "Southern Night" rice is a rice variety developed in Russia with high levels of anthocyanins, which can be used as potential quorum sensing inhibitors against microbial biofilm formation. Extraction was carried out by maceration and with the addition of hydrochloric acid to the extractant until a concentration of 0.1% was obtained.

Varying the ethanol-water ratio in the extracting mixture we found that the optimal extract's consistency can be reached when 50% ethanol is used for at 18 °C (Table 1). Increasing both the water content in mixture and extraction time led to increase the mass of the thick extract. Probably, this is caused by the hydration of the crude extract. Using the HPLC-UV technique (Agilent-1220 YMC C18 column, 250\*5.4 and detection at 280 nm) total content of anthocyanins was determined. The mobile phase was 10% acetonitrile and 90% 0.1% formic acid solution. The results are presented in Figure 1. In order to establish the composition, the sample C and D were selected in accordance with their consistency. Each sample was re-dissolved in water and re-extracted by isoamyl alcohol to purify it from the oligosaccharides. Then it was dissolved in methanol and purified by C18-solid phase extraction from the endogenous admixtures like RNA, DNA and phospholipids. After purification methanol was removed and obtained sample was re-dissolved in water. The aqueous solution was analyzed by the HPLC coupled with mass-spectrometry (Xevo QTof UPLC). The analysis performed showed that the cyanidin:peonidin ratio in sample C was 60%:40% (Table 1). For sample D, the cyanidin:peonidin:pelargonidin ratio is 15%:57%:28%. The results obtained are important for the real application of the "Southern Night" rice for the production of anthocyanins.

**Table 1.** The experimental conditions for the extraction of anthocyanins

Temperature, °C		Ethanol content in extractant, %		
		20%	60%	100%
Extraction time, day	1	A (4°C)	B (18°C)	C (30°C)
	2	D (30°C)	E (4°C)	F (18°C)
	4	G (18°C)	H (30°C)	I (4°C)

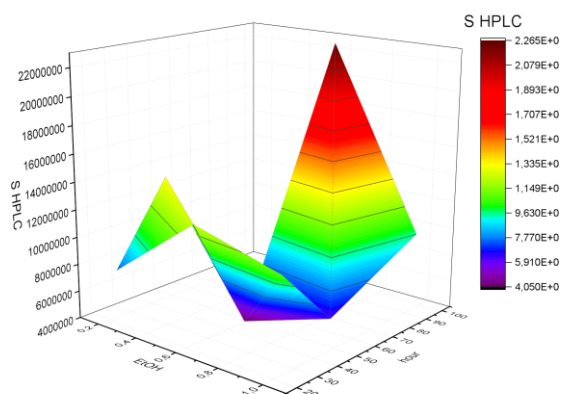

**Figure 1.** The dependency of the total anthocyanins content (S HPLC) on the time (hours) and ethanol fraction (0-1) during the extraction from "Southern Night" rice.

## Acknowledgements

This work was supported by the Russian Science Foundation (project No № 23-73-10158).

## MODIFICATION OF RADACHLORIN WITH SELENIUM NANOPARTICLES AND AN AMPHIPHILIC MOLECULAR BRUSH FOR USE IN PDT

*Morozova P.Yu.<sup>2</sup>, Valueva S.V.<sup>1,2</sup>, Danilova A.B.<sup>1</sup>*

<sup>1</sup> N.N. Petrov National Medical Research Center of Oncology, St. Petersburg, the Russian Federation

<sup>2</sup> NRC "Kurchatov Institute" Institute of Macromolecular Compounds RAS, Saint Petersburg, Russia  
[aravenko.polina@yahoo.com](mailto:aravenko.polina@yahoo.com)

One of the important areas of modern medical research is the development of new effective methods for treating cancer. A promising approach to the diagnosis and treatment of malignant neoplasms is fluorescence diagnostics and photodynamic therapy (PDT). PDT is a method based on the interaction of light with a photosensitizer (PS), localized primarily in tissue affected by malignant neoplasms (MN), which leads to the formation of cytotoxic forms of oxygen and the death of cancer cells. To improve the properties of PS, various approaches are used, in particular, it is promising to create complexes based on PS, polymers and nanoparticles (NPs). In this case, the polymer acts simultaneously both as a stabilizer of nanoparticles in solution and as a nanocontainer for targeted delivery of PS. The generation of singlet oxygen is enhanced due to the intra-complex transfer of photoexcitation energy from NPs to PS molecules. One of the most promising pharmaceutical substances of the chlorine series is Radachlorin® (RCh), a domestic drug based on the di-N-methylglucamine salt of chlorin e6.

In order to create new highly effective PS for PDT, we synthesized a hybrid ternary nanosystem (HTN)  $\text{Se}^0/\text{Cell-graft-PMAA}/\text{PC}$  based on RCh, selenium NPs ( $\text{Se}^0$ ) and a polymer stabilizer (PS) - an amphiphilic molecular brush with cellulose as the main chain and hydrophilic side chains of polymethacrylic acid (PMAA) (Cell-graft-PMAA). Initially, selenium NPs were stabilized with a polymer (Cell-graft-PMAA) followed by the introduction of RCh. The concentrations of  $\text{Se}^0$ , Cell-graft-PMAA and RCh were fixed:  $C_{\text{Se}} = 0.001$  wt. %,  $C_{\text{Cell-graft-PMAA}} = 0.01$  wt. %,  $C_{\text{RCh}} = 0.002$  wt. %,  $v_1 = C_{\text{Se}}/C_{\text{Cell-graft-PMAA}} = 0.1$ ;  $v_2 = C_{\text{RCh}}/C_{\text{Cell-graft-PMAA}} = 0.2$ .

Spectral studies of the synthesized HTN were carried out. Comparison of the absorption spectrum of HTN with the absorption spectrum of free RCh at the same concentrations allows us to draw a conclusion about the interaction of the components with each other. The weakly expressed RCh band with a maximum at  $\lambda = 280$  nm in the ternary system "degenerates" into a plateau in the range  $\lambda = 250\text{--}285$  nm, which may indicate a connection between selenium NPs and RCh (selenium absorbs at  $\lambda = 265$  nm). In this case, the Soret band changes (the maximum of this band is at  $\lambda = 403$  nm), which characterizes the interaction along the porphyrin ring of RCh: both a decrease in the intensity of the optical density and a change in the shape of the Soret band are observed. Changes are also observed in the Q-region, indicating the interaction of peripheral groups of RCh with the components of the ternary system. For HTN in the range of 490-575 nm, a twofold increase in optical density is observed. The characteristic band in the spectra for free RCh at  $\lambda = 650$  nm, for HTN shows a shift to short wavelengths (hypsochromic shift) by 11 nm, which may indicate, in particular, a decrease in the size of the observed objects.

The localization and accumulation of HTN in human bladder cancer tumor cells 587 BICan TVV (patent RU 2742244 dated 02/04/2021) at the 12th passage was studied using confocal microscopy. PC was used as a positive control; bladder cancer cells without exposure to the test substances served as a negative control. The concentration of HTN introduced into the nutrient medium was 20  $\mu\text{g}/\text{ml}$ . After incubation time (48 h + 24 h), the cells were washed from the nutrient medium with HTN, the cell nuclei were stained with Hoechst 33342 (Sigma Aldrich, USA) for 10 minutes, washed from the dye and visualized using a fluorescent confocal microscope (Olympus FV3000, Japan). A comparative analysis of the accumulation of the drug HTN and RCh in cells was carried out, based on the results of which it can be concluded that HTN, like RCh, is localized in the cytoplasm of cells and has comparable fluorescence.

Thus, the synthesized HTN is promising for creating on its basis photosensitive hybrid compounds for the treatment and diagnosis of oncological diseases using PDT.

### Acknowledgements

This work was supported by the Russian Science Foundation (project No 24-25-00413).

# OPTIMIZATION OF SELECTIVITY AND STABILITY OF ALREADY SELECTED APTAMER FOR BSA

*Nbeaa A., Moustapha A. Y., Nour and El-Deeb A.A.*

ITMO University, SCAMT, St. Petersburg, Russia  
Master student, nucleic acid and nanobiotechnology laboratory  
[nbeaa@scamt-itmo.ru](mailto:nbeaa@scamt-itmo.ru)

Aptamers have garnered significant interest in the 20th century as a promising alternative to antibodies for various applications due to their ease of production and cost-effectiveness. Their small size enables *in vivo* use by evading the immune system. However, a major challenge lies in their unstable binding in aqueous environments, limiting their effectiveness. The initial attractiveness of aptamers as a replacement for antibody therapy was their strong binding affinity, indicated by a low dissociation constant ( $K_d$ ). However, their practical effectiveness is faced by a high dissociation rate ( $K_{off}$ ) in aqueous environment, making it difficult to maintain stable interactions with target molecules. This drawback has motivated scientists to enhance aptamer design and enhance their efficacy for various applications in diagnostics, therapeutics, and biosensing. The research purpose is to optimize the affinity and the stability of already selected Aptamers for BSA.

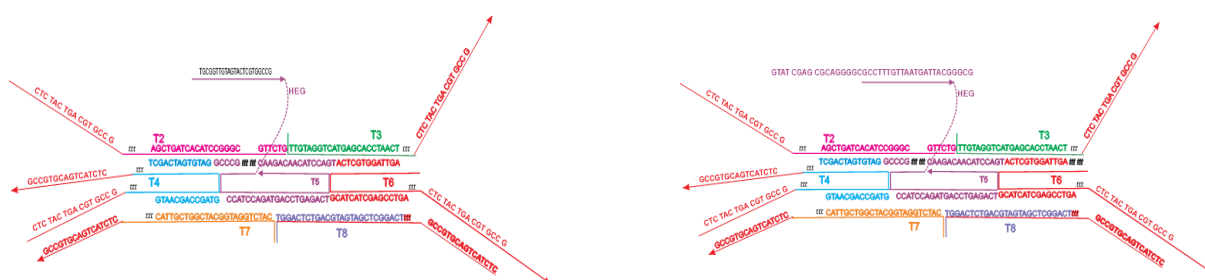

**Scheme 1.** Scaffold with the (short & long) aptamer in the middle.

After conducting a thorough review of existing studies, we identified aptamers A and B as promising candidates for targeting bovine serum albumin (BSA). We developed scaffold designs to protect these aptamers in aqueous environments. Future plans: conducting experiments to investigate how well the aptamers we have can bind to the protein, and to see how our new designs affect the rate at which the aptamers dissociate from the protein ( $K_{off}$ ). We will compare these results to the aptamers that do not bind to scaffolds to evaluate the effectiveness of our designs.

## References

- [1] *Biopolymers* **2021**, 112(3), e23421
- [2] *J. Mat. Chem.* **2012**, 22, 6053-6060

## Acknowledgements

The project was supported by project of ITMO University's priority 2030 Development strategy 922017.

SYNTHESIS OF NEW METHYL  
5-(2-METHOXY-2-OXOETHYL)-1-ARYL-1,2,3-TRIAZOLE-4-CARBOXYLATES

*Nepochatyi G.D.*<sup>1</sup>, *Popova E.A.*<sup>1</sup>

<sup>1</sup> St. Petersburg State Institute of Technology (Technical University), St. Petersburg, Russia  
PhD student  
[nepochatyy99@yandex.ru](mailto:nepochatyy99@yandex.ru)

In biological systems, it is easy to observe the versatile activity of triazole compounds containing two carbon atoms and three nitrogen atoms in a five-membered aromatic azole chain. These compounds easily interact with various enzymes and receptors. The triazole nucleus, as a central structural component, is present in many classes of medicines, such as antibacterial, antifungal, antitumor, antioxidant, antiviral, anti-inflammatory, painkillers, antiepileptic, hypotensive, antidepressants, antidiabetic, sedatives and anti-tuberculosis drugs [1].

In this work, new representatives of triazoles were obtained using the interaction of aromatic azides and acetonidicarbonylic acid diethyl ether (scheme). The reaction is carried out for 48 to 72 hours in anhydrous methanol with the equimolar presence of triethylamine. As a result, the obtained triazoles **2b-c** precipitate in the form of white crystals, and triazole **1a** requires purification by preparative chromatography. The structure of the new triazoles has been proven by <sup>1</sup>H and <sup>13</sup>C NMR spectroscopy and mass spectrometry.

As a result of virtual screening using the «Pass Online» service, the obtained triazoles **3a-c** showed a high probability of anti-asthmatic action ( $P_a = 0.79$ ,  $P_i = 0.02$ ), triazole **1a** also showed a high probability of inhibition of Acrocyllindropepsin, Chymosin and Saccharopepsin. Such predictions are of interest for further studies of the biological activity of this class of compounds.

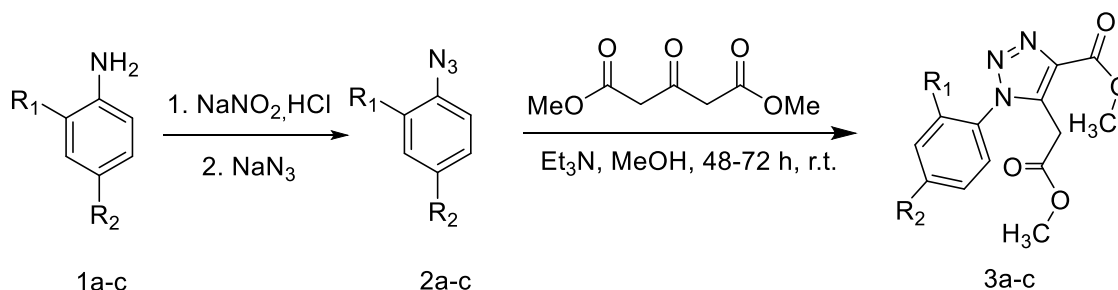

**Scheme 1.** Scheme of synthesis of new triazoles. 1-3: R<sub>1</sub> = NO<sub>2</sub>, R<sub>2</sub> = H (**a**), R<sub>1</sub> = H, R<sub>2</sub> = CF<sub>3</sub> (**b**), R<sub>1</sub> = H, R<sub>2</sub> = 1,2,3-thiadiazol-4-yl (**c**).

#### References

[1] *J. Iran Chem. Soc.* **2021**, *18*, 2535

## MULTIVALENT ANTISENSE OLIGONUCLEOTIDES FOR EFFICIENT RNA CLEAVAGE

*Nnanyereugo V.O., Dubovichenko M.V., and El-Deeb A.A.*

ITMO University, SCAMT, St. Petersburg, Russia  
Graduate student, Nucleic acid and Nanobiotechnology Laboratory  
[nnanyereugo@scamt-itmo.ru](mailto:nnanyereugo@scamt-itmo.ru)

Antisense oligonucleotides (ASO) are approximately 15-30 nt long synthetic single-stranded oligonucleotides complementary to mRNA targets. ASO technology uses short oligonucleotides that bind to targeted RNA via Watson-Crick base pairing, causing RNase-H dependent degradation and suppressing its biological function. Despite their potential as therapeutic agents, ASOs face challenges in selectivity and efficiency which limits their clinical application [1]. On the other hand, Multivalent recognition and binding of biological molecules is a natural phenomenon that increases the binding stability without decreasing the recognition specificity [2].

The aim was to increase the efficiency and maintain high specificity of RNA cleavage using multicomponent associations of ASOs. To achieve this goal the next objectives were completed; (i) To design antisense oligonucleotide sequences complementary to selected target. (ii) To conduct experiments with designed ASOs in near physiological conditions.

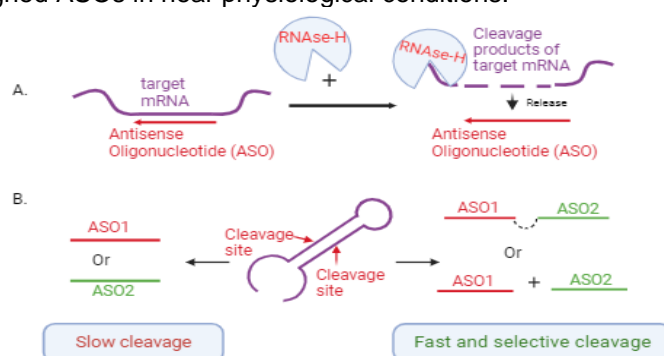

**Figure 1.** Principle of conventional (A) and Multivalent (B) ASO technology.

Various ASO agents were designed (single oligonucleotide sequences as well as bivalent oligonucleotides) to target selected sequences of RNA-58, a fragment from a gene *strA*, coding protein *strA* responsible for streptomycin resistance [3]. RNA-58 (chosen due to its highly stable secondary structure with limited availability for DNA:RNA hybridization) was incubated with each ASO, individually and in tandems, to cooperatively and independently bind to RNA-58 and cleave it at two local sites. This combination is thought to significantly enhance their affinity for RNA, thereby increasing cleavage rate. The reaction time was 20 minutes. The concentration ratio of Dz/ASO to RNA was 1:10 (100 nM and 1000 nM respectively), with the ratio of RNase H like the cleaving agent. The incubation was carried out in a near-physiological buffer solution (1 mM MgCl<sub>2</sub>, 20 mM NaCl, 50 mM HEPES, and 150 mM KCl). Stop buffer (90% formamide, 25 mM EDTA) was added to the incubation mixture to stop the reaction. From the results, we obtained that some multivalent associations of ASO agents show improved RNA cleavage efficiency which was maintained at reduced concentrations. The highest cleavage efficiency (approximately 89%) was displayed by a bivalent ASO variant (BivASO) as compared to a bivalent DNAzyme variant (BDD-O) (71%). As a hypothesis, this difference can be attributed to the longer target binding sequence of BivASO, which gives more room for binding, as against shorter substrate arms of BDD-O.

In conclusion, an analysis of the impact of multivalent associations on RNA cleavage efficiency was conducted. Improved efficiency from some variants shows great prospect in overcoming the low efficacy and selectivity associated with the use of ASOs in clinical applications.

### References

- [1] *Nucleic Acid Ther.* **2022**, 32(5), 412-420
- [2] *Nucleic Acids Res.* **2024**, 1-14
- [3] *Nucleic Acids Res.* **2003**, 31, 3406-3415

### Acknowledgements

This work was supported by project of ITMO University's priority 2030 Development strategy №922017.

## THE EFFECT OF GENETIC MODIFICATION ON THE LEVEL OF TRANSGLUTAMINASE 1 IN SKIN CELLS: EVALUATION OF EFFECTIVENESS AND SAFETY

*Ponomarev A.S.<sup>1</sup>, Norkin R.R.<sup>1</sup>, Yanigina L.M.<sup>1</sup>, Khusainova L.A.<sup>1</sup>, Vovchenko A.A.<sup>1</sup>, Rizvanov A.A.<sup>1</sup>*

<sup>1</sup> Kazan (Volga Region) Federal University, 420008

Kazan Federal University, Russia

Student

[rrnorkin@stud.kpfu.ru](mailto:rrnorkin@stud.kpfu.ru)

The group of ichthyoses, in particular lamellar ichthyosis (LI), is characterized by a defect in the epidermal barrier, leading to hyperkeratosis, peeling of the skin and inflammation due to a deficiency of the TGM1 enzyme caused by a mutation of the TGM1 gene. Complications of ichthyosis can interfere with the physical development and growth of a child due to impaired heat transfer in early childhood. There is also an increased risk of skin superinfections and transepidermal water loss, which can lead to sepsis and death. The development of a therapy based on the use of genetic modification by the coding gene of transglutaminase 1 (TGM1) will restore the level of the deficient enzyme.

Two modification methods were investigated: plasmid transfection and virus vector transduction. Experiments were conducted on primary fibroblasts and HEK293T, HaCaT cell cultures to analyze gene and protein expression. The effectiveness of the developed design was confirmed in in vitro studies using real-time PCR, Western blot and annexin V analysis.

Fibroblast and HEK293T cell cultures after modification by the pAAV2-TGM1 plasmid contained  $1,6 \cdot 10^{12}$  copies of the gene and  $2,59 \cdot 10^{11}$  copies of the TGM1 gene per 1 microgram of total RNA (tRNA), respectively. After transduction by the AAV2-TGM1 virus, the number of copies of the gene in fibroblasts and HEK293T was  $8,25 \cdot 10^7$  and  $2,18 \cdot 10^6$  copies of the gene per 1 microgram of tRNA, respectively. At the same time, when assessing the viability of the HEK293T cell culture, there were no differences in the control and experimental groups on day 3, and on day 7, there was an 8% decrease in viability in the group after viral vector transduction.

In addition, real-time PCR was performed on genes that are expressed predominantly in basal (cytokeratin 5 (SK5)) and differentiated (cytokeratin 10 (CK10) and involucrin) keratinocytes and primary fibroblasts. Thus, in the experimental group of fibroblasts after transfection, the expression of SK5 was reduced by 99%, the involucrin gene by 94% and the CK10 gene by 99% compared with the control culture. The transfected keratinocyte culture showed no change in the expression of the involucrin gene and a decrease in the CK10 gene by 99.9% copies compared with the control group.

Thus, it was demonstrated that the modification of fibroblasts and HEK293T using transfection and transduction methods allows the generation of cell cultures overexpressing the TGM1 gene. At the same time, there is a significant change in the expression of the genes SK5, CK10, and involucrin.

### **Acknowledgements**

The work was carried out at the expense of a subsidy allocated to Kazan Federal University to fulfill a state task in the field of scientific activity. Project no. FZSM-2023-0011.

# INTERACTION OF NITROSYL IRON COMPLEXES WITH SUBSTRATES IN MODEL BIOLOGICAL SYSTEMS AND BIODISTRIBUTION OF THEIR DECOMPOSITION PRODUCTS

*Novikova V.O.*<sup>1</sup>, *Pokidova O.V.*<sup>1</sup>, *Kulikov A.V.*<sup>1</sup>, *Emel'yanova N.S.*<sup>1</sup>, *Konyukhova A.S.*<sup>1</sup>,  
*Sanina N.A.*<sup>1,2,3</sup>

<sup>1</sup> FRC of Problems of Chemical Physics and Medicinal Chemistry, RAS, Chernogolovka, Russia

<sup>2</sup> Lomonosov Moscow State University, Moscow, Russia

<sup>3</sup> Scientific and Educational Center "Medical Chemistry", Mytishchi, Russia

Postgraduate

[veronika@icp.ac.ru](mailto:veronika@icp.ac.ru)

Nitrosyl iron complexes (NICs) (complex **1** –  $\text{Na}_2[\text{Fe}_2(\text{S}_2\text{O}_3)_2(\text{NO})_4] \cdot 4\text{H}_2\text{O}$  [1], **2** –  $[\text{Fe}(\text{SC}(\text{NH}_2)(\text{NHC}_2\text{H}_5))_2(\text{NO})_2]^+ \text{Cl}^- \cdot [\text{Fe}(\text{SC}(\text{NH}_2)(\text{NHC}_2\text{H}_5))\text{Cl}(\text{NO})_2]^0$  [2], **3** –  $[\text{Fe}_2(\text{SC}_6\text{H}_3\text{Cl}_2)_2(\text{NO})_4]$  [3]) considered in this work are effective donors of nitrogen monoxide (NO). They have therapeutic potential for the treatment of socially significant diseases, including cardiovascular and oncological diseases. It is assumed that, in living organisms, NICs and their decomposition products can interact with Fe- (e.g. various forms of hemoglobin) and SH-containing proteins (mucin). Taking into account that NICs in solutions spontaneously release NO without additional photo-, thermo-, and enzymatic (as nitroglycerin) activation, we assume that the oral method of administration of potential drugs based on them is the most optimal since there is no contact with the solvent outside a living organism. Therefore, the purpose of this work is to study the characteristics of the transformation of NICs with various functional sulfur-containing ligands in biological systems *in vitro* and the biodistribution of dinitrosyl iron fragments *in vivo*.

The physicochemical (UV-Vis spectrophotometry, EPR spectroscopy, Griess reaction), biological, and theoretical (quantum-chemical modeling) methods allowed us to draw the following conclusions.

The level of NO generation by complexes **1** and **3** decreases in the presence of mucin in the reaction mixture. This can be explained by the adsorption of the complexes and their decomposition products on the protein surface due to weak intermolecular interactions [4].

Complexes **1** and **2** are adsorbed on oxyhemoglobin, deoxyhemoglobin, and methemoglobin, which affects their NO-donating properties. The EPR spectrum of the complexes in the presence of oxyhemoglobin show that an axial anisotropy of the g-factor is observed, which indicates that the rotation of paramagnetic centers is inhibited due to the binding of the decomposition products of the initial NICs to the protein molecule [5]. Deoxyhemoglobin stabilizes complex **1** and **2**. This occurs as a result of their interaction with oppositely charged amino acid residues of the protein. Moreover, deoxyhemoglobin is an endogenous NO depot due to its coordination with heme iron.

It was also shown that the signal characteristic of the  $[\text{Fe}(\text{NO})_2]^+$  fragment with g~2.03 is detected in EPR spectra in organs (brain, heart, liver, kidneys, stomach, and duodenum), whole blood, and plasma of mice after intragastric administration of complex **1**.

Thus, we can conclude that when administered orally, mucin can interact with NICs and their decomposition products; they are successfully absorbed into the bloodstream, where, by binding to proteins and thiols in the blood, they are distributed throughout the organs.

## References

- [1] *Russ. J. Coord. Chem.* **2005**, 31(50), 301
- [2] *J. Coord. Chem.* **2016**, 69(5), 812
- [3] *Dalt. Trans.* **2023**, 52(9), 2641
- [4] *JACS Au* **2021** 1(7), 998
- [5] *Russ. Chem. Bull.* **2023** 72(4), 902

## Acknowledgements

This work was supported by the Russian Science Foundation (№ 22-73-10049, <https://rscf.ru/en/project/22-73-10049/>).



## POLYSACCHARIDE-BASED PREDNISOLONE DELIVERY SYSTEMS

*Novikova V.P.<sup>1</sup>, Dubashynskaya N.V.<sup>1</sup>, Skorik Y.A.<sup>1</sup>*

<sup>1</sup> Institute of Macromolecular Compounds of the Russian Academy of Science, St. Petersburg, Russia  
MS Student

[novikova.veronika.ya@gmail.com](mailto:novikova.veronika.ya@gmail.com)

Polymer conjugates control the release of an active pharmaceutical ingredient into tissues, reduce the severity of side effects, therefore this strategy is often and successfully used to improve the biopharmaceutical properties of glucocorticoids [1].

In this work, prednisolone conjugates with chitosan were synthesized in two steps: **(1)** the preparation of succinyl-prednisolone and **(2)** its coupling with low molecular weight chitosan (MW 15000 Da, degree of deacetylation 97%) using different carbodiimide reagents (Scheme 1): 1-ethyl-3-(3-dimethylaminopropyl)carbodiimide (EDC), 1-(3-dimethylaminopropyl)-3-ethylcarbodiimide hydrochloride (EDC·HCl), N,N'-dicyclohexylcarbodiimide (DCC), and N-hydroxysuccinimide (NHS). The preparation method was optimized to adjust the degree of conjugation from 2.6 to 4.0 %.

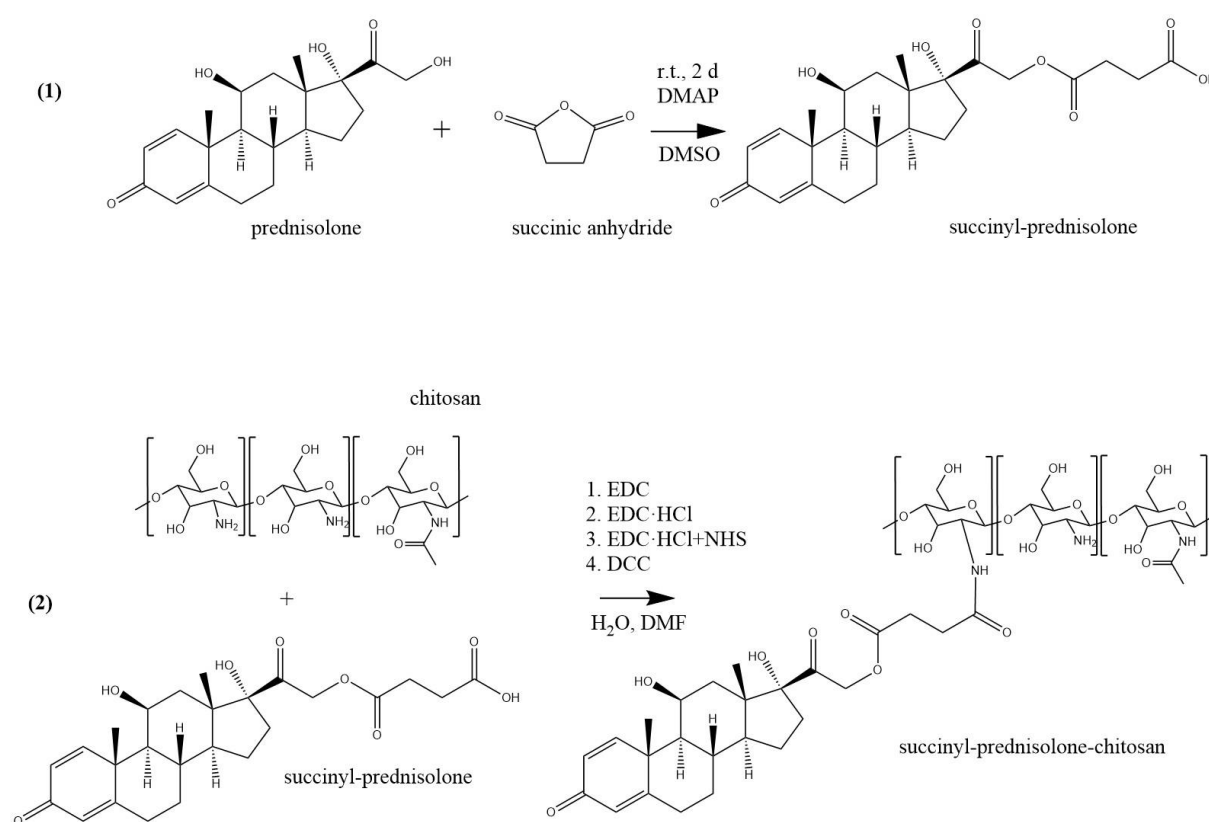

**Scheme 1.** Synthesis of prednisolone conjugate with chitosan.

The resulting conjugates self-assemble into nanoparticles (hydrodynamic size of 500-600 nm and  $\zeta$ -potential of 34-37 mV) and show modified drug release (up to 70% per month) while maintaining anti-inflammatory activity. This makes them promising candidates for biomedical applications.

### References

[1] *Biomedicines* **2021**, *9* (4), 341

# APPLICATION OF POLYCARBONYL COMPOUNDS AND THEIR HETEROCYCLIC DERIVATIVES IN BIOMEDICINE AND BIOTECHNOLOGY

*Novokshonova A.D.*<sup>1,2</sup>

<sup>1</sup> Institute of Ecology and Genetics of Microorganisms UrB RAS, Perm, Russia

<sup>2</sup> Perm State University, Perm, Russia

Student

[ananowbio@yandex.ru](mailto:ananowbio@yandex.ru)

Polycarbonyl compounds have diverse applications in biotechnology, agriculture, and medicine. They are utilized as antimicrobial agents, anti-tumor drugs, plant fertilizers, and pesticides [1]. Our research focuses on the application of various polycarbonyl compound classes as enhancers of europium luminescence and plant growth stimulants.

The ability of polycarbonyl compounds to coordinate metal cations has been harnessed to produce europium complexes with long-lived luminescence. These complexes are encapsulated within protein nanoparticles composed of bovine serum albumin and gelatin [2]. Europium-loaded protein nanoparticles serve as labels in fluorescent immunoassays.

Another promising application of polycarbonyl compounds is the stimulation of microalgae growth. Microalgae, microorganisms with significant biotechnological potential, are sources of natural colorants, vitamins, proteins, sugars, and other valuable metabolites. Consequently, there is a growing need for chemicals that promote their growth and metabolite accumulation.

## References

[1] *Molecules* **2024**, *29*, 2089.

[2] *Pharmaceutics* **2021**, *13*, 1537.

## Acknowledgements

This work was supported by the Russian Science Foundation (project No 24-25-00266).

# HYPERBARIC IMDAF REACTION BETWEEN BIS-FURYL DIENES AND FUMARIC ACID ESTERS

*Novoselskaya Y.S.<sup>1</sup>, Podrezova A.G.<sup>1</sup>, Nikitina E.V.<sup>1</sup>*

<sup>1</sup> Peoples' Friendship University of Russia named after Patrice Lumumba,  
Faculty of Science, Moscow, Russia  
Student, 3rd year of bachelor's degree  
[novoselskayays@gmail.com](mailto:novoselskayays@gmail.com)

Domino and tandem Intramolecular Diels-Alder reactions are widely known in the scientific community and are valuable tools in organic synthesis that are frequently used for the creation of functionally substituted naphthalenes, indoles, isoindoles, quinolines and isoquinolines [1]. It is also worth noting that these reactions offer high regio- and stereo control. Additionally, they are quite simple to implement under experimental conditions and reliable in use.

Building on our previous research on tandem Diels-Alder reactions between bis-furyl dienes and various dienophiles [2-4], this work focuses on the interaction of bis-furyl dienes and fumaric acid esters under various conditions was studied in detail.

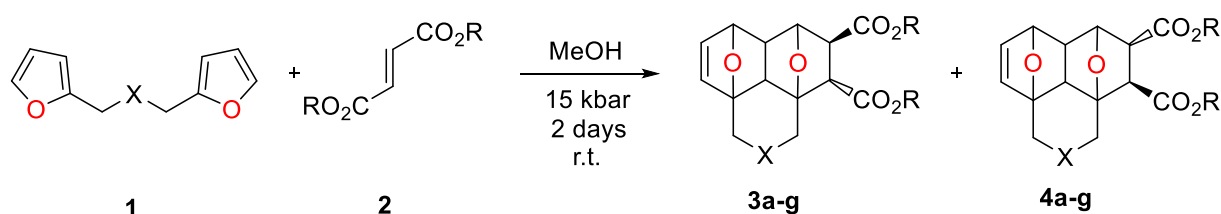

X= O (R= Et-88% (85:15), Me-45% (67:33)), S (R= Et-75% (62:38), Me-39% (63:37)),  
NBz (R= Et-72% (71:29), i-Pr-57% (73:27), i-Bu-61% (72:28))

**Scheme 1.** General scheme of the Diels-Alder reaction between bis-furyl dienes and fumaric acid esters.

Due to the absence of the formation of the main reaction products at room temperature and under heating, ultra-high-pressure conditions were applied. Pericyclic intermolecular reactions have a significant negative activation volume, therefore, in addition to thermal activation of the Diels-Alder reaction, activation by pressure is also possible. The interaction between difurfuryl ether and diethyl fumarate was chosen as a model reaction (Table 1). As a result of the reactions, according to NMR of the reaction mixtures, diastereomers 3a-g and 4a-g (Scheme 1) were obtained in good yields.

Conditions	Pressure, kbar	Exposure time	Bis-diene 1 conversion, %	Ratio of isomers 3 and 4, %
1	15	2 days	88	85:15
2	15	4 days	92	66:34
3	15	1 day	75	67:33
4	10	2 days	57	67:33
5	5	2 days	-	-

**Table 1.** Optimization of reaction conditions.

## References

- [1] *Org. Biomol. Chem.* **2022**, *20*, 2320-2355  
 [2] *J. Org. Chem.* **2018**, *83*, 4840-4850  
 [3] *Chem. Heterocycl. Compd. (NY)* **2021**, *57*, 949-961  
 [4] *ChemComm.* **2018**, *54*, 2850-2853

DIVERGENT REARRANGEMENT IN THE CONSTRUCTION OF PYRROLO[2,1-*b*][3]BENZAZEPINE AND PYRIDO[2,1-*a*]ISOQUINOLINE SCAFFOLDS UNDER DIFFERENT CONDITIONS

*Obydennik A. Y.*<sup>1</sup>, *Titov A. A.*<sup>1</sup>, *Varlamov A. V.*<sup>1</sup>

<sup>1</sup> Peoples' Friendship University of Russia (RUDN University), Moscow, Russia

PhD student

[arina.abydennik@gmail.com](mailto:arina.abydennik@gmail.com)

[3,3]-Sigmatropic rearrangements are quite versatile and convenient method for the synthesis of heterocycles [1-3]. In this work we present the transformation of 1-ethynyl-2-vinyl substituted tetra(di)hydroisoquinolines under microwave (MW) irradiation in the presence of different nucleophiles, Cu (I) salts or organic bases (Scheme 1).

In toluene at 150 °C under the action of nucleophiles (DMAP, triphenylphosphine and tetrahydrothiophene) (path A) or at 210 °C (path B) 1-substituted 1-ethynyl-2-vinyl- and tetrahydroisoquinolines undergo [3,3]-sigmatropic rearrangement providing pyrrolo[2,1-*b*][3]benzazepines **3**, **4** in good yields [4]. The replacement of toluene with acetonitrile directs the rearrangement towards the formation of pyrido[2,1-*a*]isoquinolines **6**.

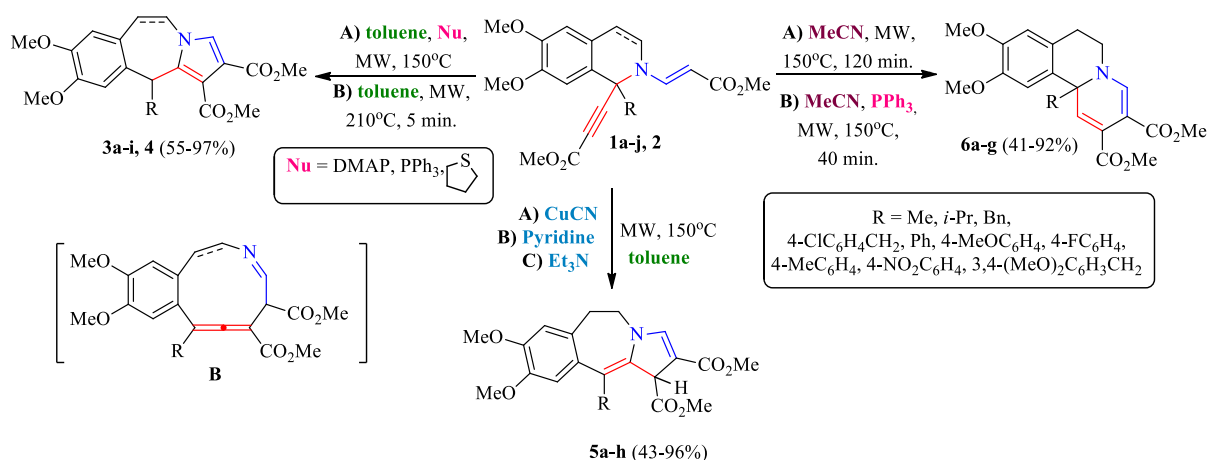

**Scheme 1.** Approaches towards the synthesis of pyrrolo[2,1-*b*][3]benzazepines and pyrido[2,1-*a*]isoquinolines.

On the other hand, the use of Cu (I) salts or organic base (pyridine, Et<sub>3</sub>N) as catalyst in toluene leads to formation of 1*H*-pyrrolo[2,1-*b*][3]benzazepines. It is assumed that the formation of compounds **3-5** occurred from the allene-bearing benzazecine (intermediate **B**) which is formed via [3,3]-sigmatropic rearrangement of the starting isoquinolines **1-2**.

## References

- [1] *Russ. Chem. Bull.* **2021**, 7, 1213-1259
- [2] *Chem. Soc. Rev.* **2009**, 38, 3133–3148
- [3] *Catalysts* **2022**, 12, 227
- [4] *Chem. – Eur. J.* **2024**, 30, e202302919

## Acknowledgements

This work was supported by the Russian Science Foundation (project No 22-13-00038).

# THE RICHTER REACTION IN THE SYNTHESIS OF PYRAZOLO[4,3-*b*]PYRIDINE COMBRETASTATIN ANALOGS

*Ogurtsova A.D.*<sup>1</sup>, *Mikhaylov V.N.*<sup>1</sup>

<sup>1</sup> St. Petersburg State University, St. Petersburg, Russia  
Student  
[st075714@student.spbu.ru](mailto:st075714@student.spbu.ru)

Drugs acting on tubulin have long been known as effective medicines for the treatment of oncological diseases, with their mechanism of action based on the destabilization of microtubules. These are intracellular structures consisting of  $\alpha$ - and  $\beta$ -tubulin heterodimers and are part of the cytoskeleton. As a result of their destabilization, apoptotic cell death occurs [1].

Natural compounds such as colchicine, epothilone, vinblastine, and combretastatin A-4 (CA4) act on microtubules by disrupting the processes of polymerization and depolymerization of tubulin, which leads to disruption of mitotic cell division [2]. However, combretastatin A-4 has two main disadvantages: poor solubility in water, which results in low efficacy in vivo, and a tendency to isomerize into a more thermodynamically stable trans isomer, resulting in a complete loss of cytotoxicity [3].

The search for synthetic analogues of combretastatin that are water-soluble and stable to isomerization is crucial to enhancing drug efficacy, reducing toxicity, and ensuring consistent pharmacological activity. Previously, an analogue of combretastatin A-4 with an indazole ring was developed [4], but we decided to attempt to obtain a similar analogue, this time with a pyridine ring. Changing the indazole ring structure to a pyrazolo[4,3-*b*]pyridine ring in combretastatin analogues can improve pharmacological properties such as solubility, stability, and target binding, as supported by research studies. Researchers have shown high interest in developing tubulin polymerization inhibitors with a pyridine ring [5,6]. This modification can also enhance pharmacokinetics and reduce toxicity.

We have proposed a new approach to the synthesis of combretastatin A-4 analogues containing a pyrazolo[4,3-*b*]pyridine core using Richter cyclization as a key step (Scheme 1).

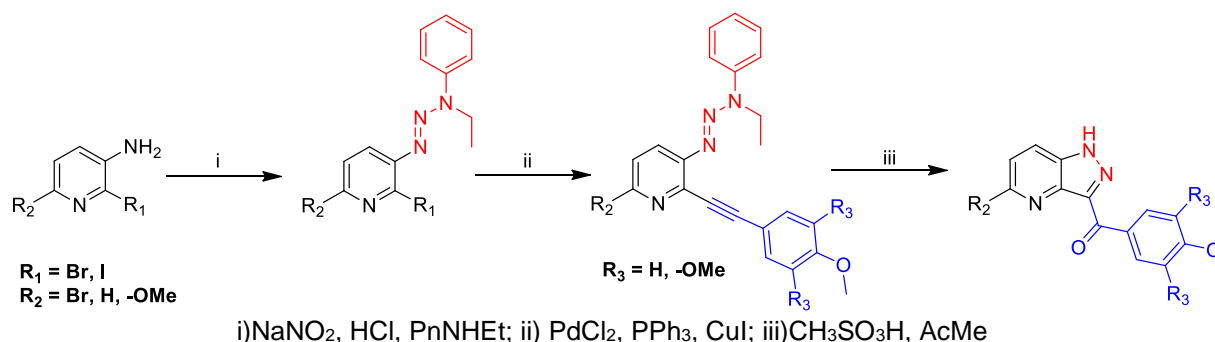

**Scheme 1.** Synthesis of pyrazolo[4,3-*b*]pyridine analogue of combretastatin.

The synthesis consists of three stages starting with commercially available derivatives of 3-aminopyridine. We obtained pyrazolo[4,3-*b*]pyridines, which were characterized by mass spectrometry,  $^1\text{H}$  and  $^{13}\text{C}$  NMR, and melting point. The research results will be presented in more detail in the report.

## References

- [1] *Med. Res. Rev.* **1998**, *18*, 259-296
- [2] *Med. Res. Rev.* **1996**, *16*(2), 207-231
- [3] *J. Med. Chem.* **2005**, *48*, 12, 4087-4099
- [4] *J. Med. Chem.* **2007**, *50*(5), 1001-1006
- [5] *Russ. Chem. Bull.* **2023**, *72*, 1012-1022
- [5] *J. Enzyme Inhib. Med. Chem.* **2022**, *37*(1), 2755-2764
- [6] *ACS Med. Chem. Lett.* **2020**, *11*(8), 1611-1619

## Acknowledgments.

NMR, HRMS studies were performed at the Saint Petersburg State University Center for Magnetic Resonance, Center for Chemical analysis.

# NOVEL CATALYST SYSTEMS FOR THE ADDITION POLYMERIZATION NORBORNENE AND IT'S DERIVATIVES BASED CATIONIC CYCLOPENTADIENYL COMPLEXES OF PALLADIUM

*Orlov T.S.*<sup>1,2</sup>, *Pakhomova M.V.*<sup>2,3</sup>, *Bykov M.V.*<sup>2,3</sup>, *Suslov D.S.*<sup>2,3</sup>

<sup>1</sup> School of High Technologies, Irkutsk National Research Technical University, Irkutsk, Russia

<sup>2</sup> Research Institute of Oil and Coal Chemical Synthesis, Irkutsk State University, Irkutsk, Russia

<sup>3</sup> Faculty of Chemistry, Irkutsk State University, Irkutsk, Russia

PhD student

[tim53145314@gmail.com](mailto:tim53145314@gmail.com)

Petroleum refining is one of the most important areas of modern industry. The process produces a wide range of chemicals. These can be used as individual compounds or as precursors for the production of other substances. One such compound is norbornene (NB) and NB derivatives (NB-R), which are obtained from unsaturated hydrocarbons. NB and some NB-R have a reliable resource base: large-tonnage products of oil refining, such as 1,3-cyclopentadiene and alkenes. The polymerization of norbornenes can be performed via three ways (ring-opening metathesis polymerization, addition polymerization (AP), and isomerization polymerization) depending on the catalyst to form polymers with different main chain structures. Addition polymers of NB and NB-R have a combination of unique properties that allow them to be used as sorbents, transparent materials for optics and medical products [1-3]. AP requires the presence of a Pd- or Ni-catalyst in the reaction mixture. Complexes based on palladium compounds are the most promising precursors of catalysts for the additive polymerization of NB and NB-R. Such as cationic methyl [4], benzyl [5] and  $\eta^3$ -allyl palladium complexes [6;7] which are commonly modified with bulky organophosphorus or N-heterocyclic carbene ligands.

Recently [8] our research group proposed a route for the synthesis of  $\eta^5$ -cyclopentadienyl palladium complexes by the interaction of acetylacetonate palladium complexes with cyclopentadiene in the presence of boron trifluoride etherate. Palladium-based cyclopentadienyl complexes showed [8] catalytic activity in the polymerization of phenylacetylene. The complexes remain stable under heating and contact with air [8] and are promising for the polymerization of norbornene.

This report presents the results of studying the catalytic properties of systems based on palladium complexes  $[\text{Pd}(\text{Cp})(\text{L})_n][\text{BF}_4]_m$  ( $\text{Cp} = \eta^5\text{-C}_5\text{H}_5$   $n=2$ ,  $m=1$ ,  $\text{L} = \text{TOMPP}$ ,  $\text{PPh}_3$ ,  $\text{TFP}$ ;  $n=1$ ,  $m=1$ ,  $\text{L} = \text{dppf}$ ,  $\text{dppp}$ ,  $\text{dppb}$ ,  $\text{dpppt}$ ,  $\text{dpph}$ ) in the addition homo- and copolymerization of norbornene NB and NB derivatives (Scheme 1). It has been found that these complexes can be activated with Lewis acids ( $\text{BF}_3 \cdot \text{OEt}_2$  or  $\text{AlCl}_3$ ). The productivity of the  $[\text{Pd}(\text{Cp})(\text{PPh}_3)_2][\text{BF}_4]/\text{BF}_3 \cdot \text{OEt}_2$  catalyst system in NB polymerization achieves 188800 ( $\text{mol}_{\text{NB}}(\text{mol}_{\text{Pd}}^{-1})$ ). The homopolymerization of 5-methoxycarbonylnorbornene and the copolymerization of NB with 5-methoxycarbonylnorbornene or 5-phenylnorbornene in the presence of  $\text{BF}_3 \cdot \text{OEt}_2$  and  $[\text{Pd}(\text{Cp})(\text{L})_2][\text{BF}_4]$  ( $\text{L} = \text{PPh}_3$  or  $\text{TFP}$ ) has been studied also. Interaction of the  $[\text{Pd}(\text{Cp})(\text{PPh}_3)_2]\text{BF}_4$  with 5 eq. of  $\text{BF}_3 \cdot \text{OEt}_2$  has been studied by  $^1\text{H}$  and  $^{31}\text{P}$  NMR, and a hypothesis for the formation of the catalyst are discussed. The structure of the  $[\text{Pd}(\text{Cp})(\text{TFP})_2]\text{BF}_4$  complex has been determined by X-ray diffraction (XRD) analysis. Based on the XRD data, the steric hindrance of the TFP ligand was estimated (the cone angle is  $149^\circ$ ), which was found to be higher than previously reported in [9] (the cone angle is  $133^\circ$ ).

## References

- [1] *Polym. Rev.* **2022**, 62, 400
- [2] *Polym. Sci. Ser. C* **2019**, 61, 145
- [3] *Prog. Polym. Sci.* **2018**, 84, 1
- [4] *ACS Macro Letters* **2015**, 4, 327
- [5] *Polym. Chem.* **2022**, 13, 4154
- [6] *J. Am. Chem. Soc.* **2009**, 131, 9055
- [7] *ACS Catalysis* **2022**, 12, 15076
- [8] *Molecules* **2023**, 28, 4141
- [9] *Chem. Rev.* **2001**, 101, 997

## Acknowledgements

This work was supported by the Government Assignment for Scientific Research from the Ministry of Science and Higher Education of the Russian Federation (FZZE-2024-0004).

## TERPHENYLDICARBOXYLIC ACID AS PROMISING LINKER FOR METAL-ORGANIC FRAMEWORKS

*Osipov A.A.<sup>1</sup>, Rajakumar K.<sup>1</sup>, Nayfert S.A.<sup>1</sup>, Zhrebtsov D.A.<sup>1</sup>, Efremov A.N.<sup>1</sup>*

<sup>1</sup> South Ural State University, Chelyabinsk, Russia

Graduate student

[aaosipov@susu.ru](mailto:aaosipov@susu.ru)

The metal-organic frameworks (MOF) with large surface area are increasingly studied in the 21st century. Such promising materials are ionic compounds consisting of metal cations and rigid organic linkers. Linear bidentate phenylene aromatic ligands are of great interest to researchers [1,2] because long ligand can enlarge MOF pore size and area. Accordingly, we aimed to synthesize terphenyldicarboxylic acids and investigate their properties.

Dimethyl-[1<sup>1</sup>,2<sup>1</sup>:2<sup>4</sup>,3<sup>1</sup>-terphenyl]-1<sup>4</sup>,3<sup>4</sup>-dicarboxylate (**1**) was synthesized by the Suzuki reaction, as a result of alkaline hydrolysis potassium [1<sup>1</sup>,2<sup>1</sup>:2<sup>4</sup>,3<sup>1</sup>-terphenyl]-1<sup>4</sup>,3<sup>4</sup>-dicarboxylate (**2**) was obtained. As a result of iodination of (**1**), the dimethyl 2<sup>2</sup>,2<sup>5</sup>-diiodo[1<sup>1</sup>,2<sup>1</sup>:2<sup>4</sup>,3<sup>1</sup>-terphenyl]-1<sup>4</sup>,3<sup>4</sup>-dicarboxylate (**3**) was synthesized. For all three compounds (Scheme 1a), single crystals were grown and investigated by X-ray diffraction analysis. All three compounds have a layered packing motif. In compound (**3**), the middle benzene ring is rotated by an angle of 63.15° (Scheme 1b); there is a halogen bond O⋯I-C between the molecules with a length of 3.146(3) Å, which is significantly shorter than the sum of the van der Waals radii. Compounds (**1–3**) have intense photoluminescence under UV illumination. The potassium salt (**2**) of terphenyldicarboxylic acid presents high thermal stability [3].

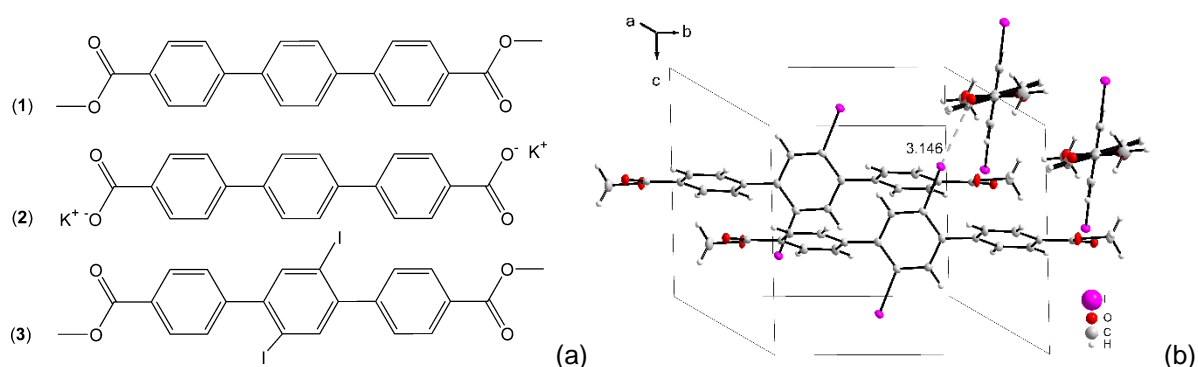

**Scheme 1.** Terphenyldicarboxylic acid derivatives:

(a) – structural formulas of compounds (**1–3**),

(b) – structure of compound (**3**).

A brominated derivative of terphenyldicarboxylic acid (**4**) was also obtained. During the solvothermal synthesis, a single crystal of MOF based on lanthanum cation, (**4**) and DMSO was grown. This framework has a porous three-dimensional structure.

Thus, the presence of photoluminescent properties of the synthesized substances and the porous structure of the obtained metal-organic framework indicate the possibility of using MOFs based on terphenyldicarboxylic acids as gas-sensitive sensors and selective sorbents for pollutants. The wide range of properties of the obtained materials opens horizons for new physicochemical studies in the field of coordination polymers.

### References

- [1] *Inorganics* **2023**, *11*, 192
- [2] *Inorganics* **2022**, *10*, 262
- [3] *Acta Crystallogr., Sect. B: Struct. Sci.* **2024**, *80*, 117–125

### Acknowledgements

This work was supported by the Russian Science Foundation (project No 23-13-00045).

## N<sup>4</sup>-ALKYLMODIFIED CYTIDINE DERIVATIONS AS MICROBIAL GROWTH INHIBITORS

*Oskolsky I.A.*<sup>1</sup>, *Alexandrova L.A.*<sup>1</sup>, *Makarov D.A.*<sup>1</sup>, *Jasko M. V.*<sup>1</sup>, *Karpenko I.L.*<sup>1</sup>, *Efremenkova O.V.*<sup>2</sup>,  
*Vasilyeva B.F.*<sup>2</sup>, *Avdanina D.A.*<sup>3</sup>, *Ermolyuk A.A.*<sup>3</sup>, *Benko E.E.*<sup>3</sup>, *Kalinin S.G.*<sup>3</sup>, *Kolganova T.V.*<sup>3</sup>,  
*Kochetkov S.N.*<sup>1</sup>, *Zhgun A.A.*<sup>3</sup>

<sup>1</sup> Engelhardt Institute of Molecular Biology RAS, Moscow, Russia

<sup>2</sup> Gause Institute of New Antibiotics RAMS, Moscow, Russia

<sup>3</sup> Research Center of Biotechnology RAS, Moscow, Russia

Postgraduate

[oskosky@yandex.ru](mailto:oskosky@yandex.ru)

Previously, we discovered the antibacterial and antifungal activity of a number of modified pyrimidine N<sup>4</sup>-alkyl-2'-deoxynucleosides, containing extended alkyl substituents at the C4 position of the cytosine residue [1,2]. In our present investigation a range of N<sup>4</sup>-alkylcytidines, encompassing derivatives of 5- and 6-methylcytidine with elongated alkyl substituents, were synthesized to advance in research dedicated to antibacterial and antifungal agents based on nucleoside derivatives [3].

Our findings demonstrate that N<sup>4</sup>-alkyl 5- or 6-methylcytidines effectively impeded the growth of molds isolated from paintings housed in the halls of the State Tretyakov Gallery, Moscow, Russia. These innovative compounds exhibit efficacy comparable to that of standard antiseptics. Additionally, the activity of N<sup>4</sup>-alkylcytidines rivals that of certain antibiotics used in medical settings against various Gram-positive bacteria, including resistant strains of *Staphylococcus aureus* and *Mycobacterium smegmatis*. Notably, N<sup>4</sup>-dodecyl-5-methylcytidine emerged as the most promising compound, offering potential for broadening the spectrum of antiseptics employed in painting conservation, given that fungal and bacterial co-infections often contribute to the deterioration of painting materials.

previous work:

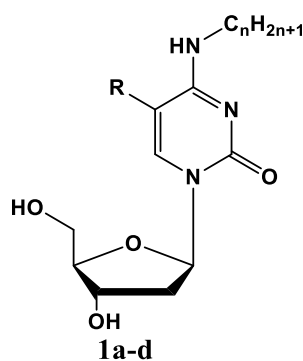

a: R = CH<sub>3</sub>, n = 10;  
b: R = CH<sub>3</sub>, n = 12;  
c: R = H, n = 10;  
d: R = H, n = 12.

current work:

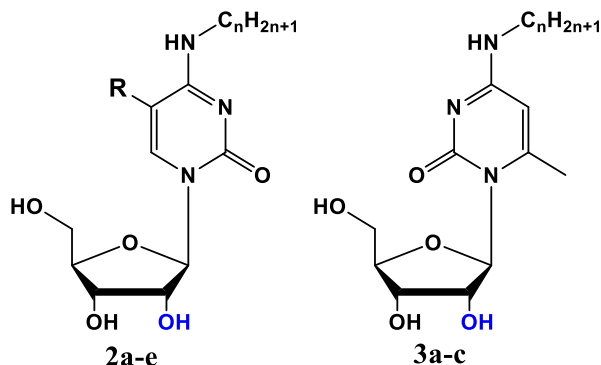

a: R = CH<sub>3</sub>, n = 10;  
b: R = CH<sub>3</sub>, n = 12;  
c: R = CH<sub>3</sub>, n = 14;  
d: R = H, n = 12;  
e: R = H, n = 14.

n = 10 (a), 12 (b), 14 (c)

**Figure 1.** Synthesized N<sup>4</sup>-alkylcytidines with antibacterial and antifungal activity.

### References

- [1] *Eur. J. Med. Chem.* **2021**, 113212
- [2] *New J. Chem.* **2022**, 46, 5614-5626
- [3] *Int. J. Mol. Sci.* **2024**, 25(5), 3053

### Acknowledgements

The work was supported by the Russian Science Foundation (Grant number: 23-14-00106).



## CHROMATOGRAPHIC CONTROL OF DIHYDROQUERCETIN DIASTEREOMERIZATION

*Pankov D.I.<sup>1</sup>, Terekhov R.P.<sup>1</sup>, Selivanova I.A.<sup>1</sup>*

<sup>1</sup> Sechenov University, Moscow, Russia

PhD student

[pankov\\_d\\_i@staff.sechenov.ru](mailto:pankov_d_i@staff.sechenov.ru)

Taxifolin is registered as an active pharmaceutical ingredient in the Russian Federation. Despite having two chirality centers in its molecule, the pharmacopoeia monograph lacks an approach to control stereochemical composition. We observed that the content of *cis*-taxifolin increases over time in aqueous solutions. This study aims to investigate the kinetics of taxifolin isomerization using HPLC-UV.

Taxifolin (Lavitol®, JSC "Ametis") was used as the research subject. Zorbax 3.5 µm SB-Phenyl 4.6 mm × 150 mm (Agilent Technologies, Inc.) was employed as chromatographic column. The mobile phase contained an acetic acid solution (96%, "for analysis", Merck KGaA) in water with a pH of 2.7 (solvent A) and methanol ("for HPLC", SPE "Aquamey") (solvent B). The concentration of solvent B was increased from 29% (0 min) to 42.3% (25 min). The flow rate was maintained at 0.464 mL/min, the column temperature was set to 30 °C, and analytical wavelength was 288 nm.

The diastereomerization process was investigated using a model system prepared by dissolving 5 mg taxifolin in 10 mL of a 1:1 aqueous methanol mixture and adding 0.5 mL of sodium hydroxide solution (0.1 M, "pure", Lachema, n.p.). Quantitative analysis of stereoisomers was performed hourly for a period of 5 hours (Fig. 1).

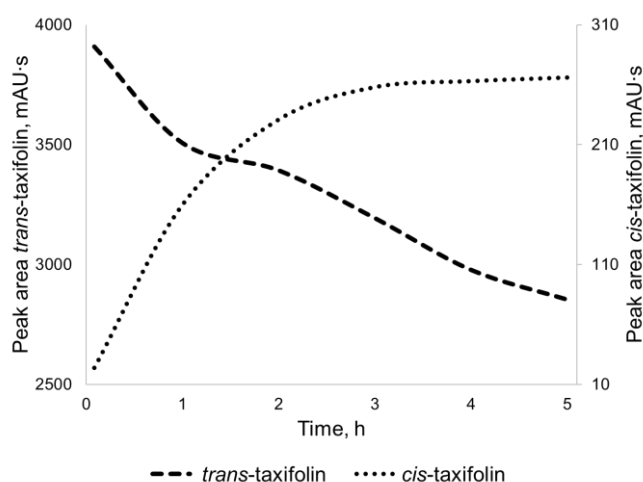

**Figure 1.** The change of concentration of taxifolin diastereomers.

When the aqueous methanol solution of taxifolin is standing, the amounts of the *cis*- and *trans*-isomers increases and decreases, respectively. When the solution is alkalinized, the reaction goes faster, but isomerization stops in the methanol medium.

Considering that the separation of stereoisomers was carried out on an achiral sorbent, peaks with retention times of 18.1 min and 19.2 min can correspond to diastereomers, which implies the reversal of the configuration of only one chirality center, C2 or C3, i.e., epimerization. According to the type of chalcon-flavonone isomerization, the C2 configuration can change. An alternative pathway, involving the formation of an endiol form, leads to a change in the configuration of C3. An in-depth study of the mechanisms of isomerization is a promising way of further research, for which it is planned to use the <sup>1</sup>H NMR spectroscopy method.

### Acknowledgements

This work was supported by the Russian Science Foundation (project No 23-75-01130).

# SYNTHESIS AND FUNCTIONALIZATION OF HALOGEN METHYL IMIDAZOLIUM SALTS

*Pasyukov D.V., Shevchenko M.A., Chernyshev V.M.*

<sup>1</sup> Platov South-Russian State Polytechnic University (NPI), Novocherkassk, Russia

Student (Junior researcher, graduate student)

[domodem89518278524@mail.ru](mailto:domodem89518278524@mail.ru)

Imidazolium salts have a wide range of applications in organic chemistry, including biological research or metal complex catalysis. Recently, we discovered a new reaction for the formation of imidazolium salts containing a chloromethyl group and also investigated the reaction with N-nucleophiles (pyridine, methylimidazole) [1,2] However, reactions with aliphatic and aromatic amines have not been investigated.

Compounds **1** proved to be inefficient in the reaction of nucleophilic substitution on various amines (scheme 1). Therefore, methods for the preparation of bromomethyl derivatives of imidazolium salts (**2**) were developed.

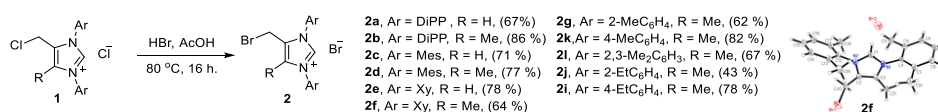

**Scheme 1.** Formation reaction of compounds **2**. **DiPP** - 2,6-diisopropylphenyl, **Mes** - 2,4,6-trimethylphenyl, **Xy** - 2,6-dimethylphenyl.

Compared to chloromethyl salts **1**, their brominated analogs **2** exhibit enhanced reactivity towards nucleophiles. Due to this, it was possible to carry out amination reactions using various derivatives of alkyl and arylamines, as well as to show the possibility of using biologically active compounds

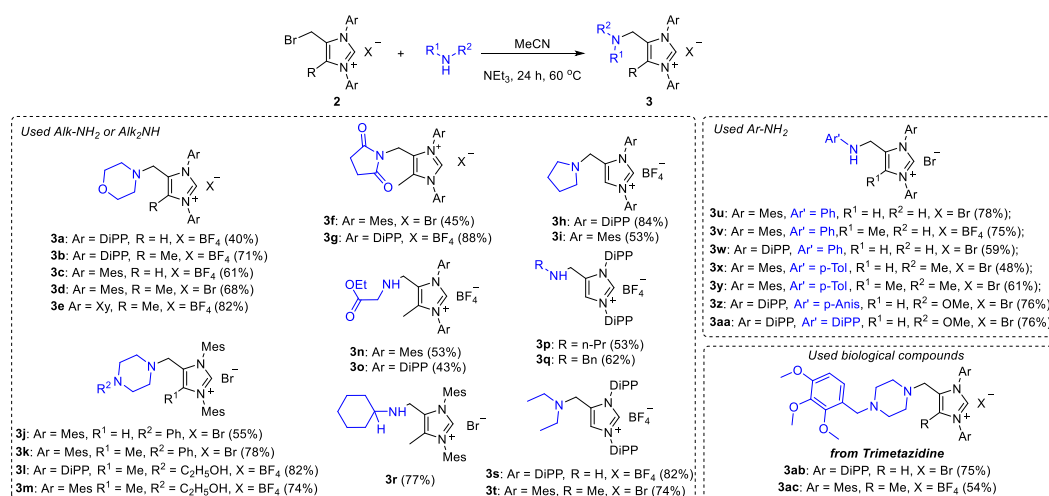

**Scheme 1.** Reaction amination of compounds **2**. **p-Tol** – 4-toluidine, **p-Anis** – 4-anisidine, **DiPP** - 2,6-diisopropylphenyl, **Mes** - 2,4,6-trimethylphenyl, **Xy** - 2,6-dimethylphenyl.

Thus, a simple method for the synthesis of highly reactive 4-bromomethyl imidazole salts (**2**) is shown, which significantly expands the possibilities of using halogenmethyl imidazolium salts, as an example, the reaction for the preparation of alkylaminomethyl (**3a-t**) or arylaminomethyl (**3u-aa**) imidazole salts is shown.

## References

- [1] *Angew. Chem. Int. Ed.* **2022**, 61
- [2] *Russ. Chem. Bull.* **2023**, 72, 1225-1232
- [3] *Chem Asian J.* **2024** in press

## Acknowledgements

The work has been supported by the Ministry of Science and Higher Education of the Russian Federation (project No 075-03-2024-152/1) at the Laboratory "Novel composite and functional materials with specific properties" within the framework of National Project "Science and Universities".

## MULTICOMPONENT ASO AGENT FOR INTRACELLULAR OVEREXPRESSION AND MUTATION RECOGNITION

*Patra C.*<sup>1</sup>, *Eldeeb A.A.*<sup>1</sup>, *Kolpashchikov D.M.*<sup>2</sup>

<sup>1</sup> ITMO University, St. Petersburg, Russia

<sup>2</sup> University of Central Florida, Orlando, USA

PhD Student, MSc

[patra@scamt-itmo.ru](mailto:patra@scamt-itmo.ru)

Although there have been significant advancements in cancer therapeutic strategies, there is still a long way to go in terms of finding an effective long term solution. Traditional anticancer therapies have been proven to cause hurdles to the patients and their families, and to be a burden for the healthcare systems. More sophisticated and patient centered cancer therapeutics are currently being researched, with gene therapy being one of the leading approaches. However, only a few anticancer gene therapy agents have made it into clinical trials, with most of these being based on therapeutic nucleic acids (TNAs) such as antisense oligonucleotides (ASOs) and small interfering RNAs (siRNAs) [1].

Despite the significant potential of TNAs, there are still many challenges that prevent them from being utilized in clinic. Cell/organelle membrane barriers, lyso/endosomal entrapment, and nonspecific and insufficient activation of therapeutic tools lead to off target effects, resulting in toxicity for healthy tissues, which is a critical issue in achieving effective treatment via TNA agents. Moreover, usually the target genes chosen for cancer gene therapy, when suppressed do not eliminate the malignant cells but merely stop their proliferation. If cancer cells stay in the body, however, there is always the risk of metastasis and relapse.

As a solution, we have previously proposed a new concept for a highly specific oncomarker sensor (HSOS). The sensor utilizes antisense oligonucleotides (ASOs), capable of efficiently targeting the desired mRNA inside cells. However, due to their length, ASOs do not always specifically bind to mRNA containing single nucleotide substitutions (SNSs) characteristic of cancer. To increase specificity towards SNSs, the developed HSOS consists of a long oligonucleotide divided into two shorter chains. This idea reduces the affinity to mRNA, preventing HSOS binding in the absence of SNSs. Both short chains will be bound to a DNA scaffold using hexaethylene glycol linkers (HEGs) to ensure their spatial proximity and increase the likelihood of binding to the same mRNA target. Additionally, both chains will be chemically modified to protect against nucleases and to cleave the mRNA target only at specific sites [2].

HSOS has been used to further functionalize a previous development of our scientific group, the binary antisense oligonucleotide (biASO) [3], which main advantage is its ability to release therapeutic effect only in the presence of an oncomarker. However, biASO lacked efficiency in cell based experiments. The addition of the HSOS is expected to i) increase target suppression efficiency in cell-based experiments by increasing target mRNA accessibility via secondary structure unwinding and fragmentation, and to ii) facilitate the differentiation of cancer from healthy cells via SNS or overexpression detection. To date we have developed two distinct designs, one directed to oncogenic SNS detection and the other directed to detection of an overexpressed oncomarker. The accurate detection will then activate the suppression of an essential gene that will cause cell apoptosis [4]. The application of classical TNAs is not feasible when targeting essential genes, due to their low specific nature, which would result in the apoptosis of all cells in the body, including healthy ones. Experiments in solution have confirmed the hypothesis of increased oncomarker dependency and SNS differentiation, with cell based experiments still needed to be done.

To conclude, the HSOS's high specificity against malignant cells will be achieved via recognition of SNS mutated or highly overexpressed markers that cannot be found in healthy cells. Therapeutic effects will be released only in the presence of such recognition, minimizing the off-target effects. This research aims to advance the field of cancer research and lay the foundation for the development of novel drugs for the individualized treatment of oncological diseases.

### References

- [1] *Front. Genome Ed.* **2021**, 3, 618346
- [2] *Angew. Chem. Int. Ed Engl.* **2020**, 59, 21190-21194
- [3] *Nucleic Acid Ther.* **2022**, 32-5, 412-420
- [4] *Angew. Chem. Int. Ed Engl.* **2019**, 58, 4654-4658

### Acknowledgements

This work was supported by the ITMO University's priority 2030 Development strategy project, №922017.

# NEW MULTICOMPONENT METHODS FOR THE SYNTHESIS OF SUBSTITUTED 1,4-DIHYDRO-1,6-NAPHTHYRIDINES

*Perepechay A.A., Sukach S.M., Dyachenko V.D.*

Lugansk State Pedagogical University, Department of Chemistry and Biochemistry, Lugansk, Russia  
Assistant at the Department of Chemistry and Biochemistry  
[chem.post@yandex.ru](mailto:chem.post@yandex.ru)

Among the 1,6-naphthyridine derivatives, compounds with antibacterial, immunosuppressive, antitumor, antiviral, anti-inflammatory, fungicidal and insecticidal activity were found, which is largely due to their ability to regulate the activity of various enzymes.<sup>1-10</sup>

Taking into account the high pharmaceutical potential of this class of organic compounds, we have developed new methods for their synthesis, consisting of the condensation of aldehydes **1** with CH-acids **2, 3**, alkyl halides **4** and amines **B** (*method a*), or reagents **1, 2** and nicotinonitriles **5** (*method b*).

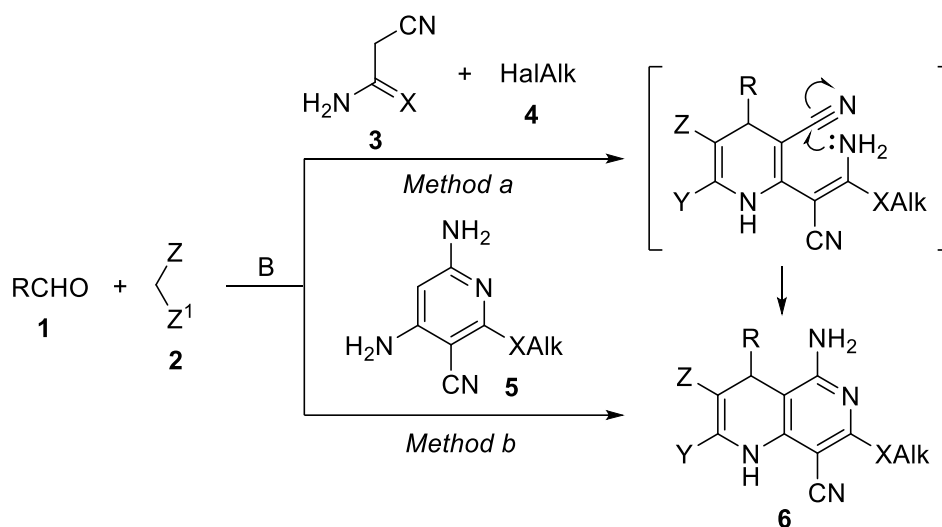

R = Alk, Ar, Het. Z = CN, C(O)Alk, COOAlk. Hal = Cl, Br, I. X = O, S, Se, C(CN)<sub>2</sub>.  
Y = OH, NH<sub>2</sub>, Alk. B = Et<sub>3</sub>N, piperidine, morpholine, *N*-methylmorpholine.

**Scheme 1.** Multicomponent synthesis of substituted 1,4-dihydro-1,6-naphthyridines.

The structure of synthesized compounds **6** was confirmed by mass, IR, and NMR spectroscopy data. Data from the PASS online web service<sup>11</sup> make it possible to classify the synthesized heterocyclic systems as drug candidates. In particular, they are capable of exhibiting inhibitory activity against certain enzymes, for example, glutamate-5-semialdehyde dehydrogenase, trans-acenaphthene-1,2-diol dehydrogenase, pterine deaminase, chloride peroxidase, and also have antitumor properties and can be used in the treatment of alopecia.

## References

- [1] *ACS Med. Chem. Lett.* **2020**, *11*, 358
- [2] *Biomed. Pharmacother.* **2021**, *134*, 111112
- [3] *Bioorg. Med. Chem.* **2020**, *28*, 115791
- [4] *Bioorg. Chem.* **2019**, *90*, 103052
- [5] *Expert Opin. Ther. Pat.* **2022**, *32*, 1043
- [6] *Front. Immunol.* **2020**, *11*, 569530
- [7] *J. Med. Chem.* **2019**, *62*, 7445
- [8] *MedChemComm* **2018**, *9*, 87
- [9] *Nucleic Acids Res.* **2019**, *47*, 1373
- [10] *Pharm. Biol.* **2020**, *58*, 1044
- [11] *Way2Drug - main.* Way2drug.com. <https://www.way2drug.com/PassOnline/index.php> (accessed 2024-04-20)

# MINIMIZATION OF SIDE PROCESSES IN SOLID-PHASE PEPTIDE SYNTHESIS USING FMOC-DEPROTECTION REAGENTS ALTERNATIVE TO PIPERIDINE

*Petropavlovskaya M.V.<sup>1</sup>, Palkeeva M.E.<sup>2</sup>, Molokoedov A.S.<sup>2</sup>, Ovchinnikov M.V.<sup>2</sup>, Sidorova M.V.<sup>2</sup>*

<sup>1</sup> Razumovsky Moscow State University of Technology and Management, Moscow, Russia

<sup>2</sup> Chazov National Medical Research Centre of Cardiology, Moscow, Russia

Student (Bachelor, first year master's degree)

[maria.petropavlovskaya@yandex.ru](mailto:maria.petropavlovskaya@yandex.ru)

Currently, solid-phase synthesis (SPPS) using Fmoc-methodology has gained the greatest popularity for the synthesis of peptides [1]. This approach offers the following advantages: speed, simple isolation of intermediate products through washing and filtration, and process automation. The stage of elimination of Fmoc protection from  $\alpha$ -amino groups during solid-phase synthesis is very important, since the quality of the resulting products largely depends on it. The availability of piperidine [1], widely used to deprotect  $\alpha$ -amino groups in SPPS peptides, is currently limited, because this reagent has the status of a certified substance [2]. The growing demand for synthetic peptides in the pharmaceutical market requires optimization and greening of the processes for obtaining these compounds. In this regard, this study focuses on the selection of an alternative deprotection reagent to piperidine suitable for use in SPPS.

The goal of the work is to search for accessible, effective reagents for the cleavage of temporary Fmoc protection, suitable for the synthesis of physiologically active peptides of various structures, which would provide high yield and purity of the target product without the formation of by-products. The work discusses the use of deprotection reagents based on cyclic secondary amines in SPPS.

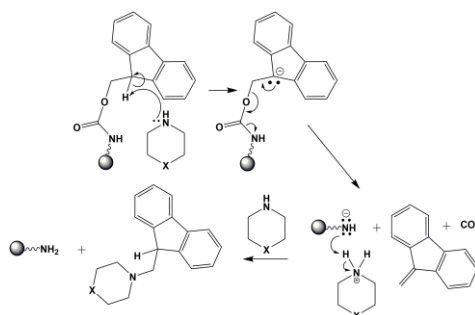

**Figure 1.** Mechanism for removing Fmoc protection by secondary amines, where X is NH, C-CH<sub>3</sub>.

The objects of synthesis were peptides of various structures: the cyclic peptide atosiban, methylin containing proline in the C-terminal part and ingramon containing an aspartic acid residue. It is known that the bases used to cleave protection during SPPS can promote the formation of DKP and aspartimides in aspartyl peptides. When synthesizing peptides, deprotection mixtures were used such as 25% 4-MePip/DMF, 20% Pyr/DMF, 5% PZ/ 2% DBU/DMF.

The results were assessed by HPLC of technical products and the total yield of purified (up to 98%) target products.

It was shown that 4-methylpiperidine (4-MePip), pyrrolidine (Pyr) and piperazine (PZ) can be used interchangeably with piperidine, since in our experiments the change in deprotection reagents did not generally affect the quality of the target products. These deprotection reagents can find application in the development of schemes for the large-scale synthesis of physiologically active peptides.

## References

- [1] *Fmoc Solid Phase Peptide Synthesis*, Oxford University Press Inc., NY **2000**, 9-37, 346
- [2] *Drug Enforcement Administration (DEA), Department of Justice. Control of immediate precursor used in the illicit manufacture of fentanyl as a schedule II controlled substance* **2010**, 75(124), 37295-9

## Acknowledgements

This work was supported by the Ministry of Health of Russia (project No 123020600073-4).

# PARTICIPATION OF ALBUMIN AND GLUTATHIONE IN THE BIOTRANSFORMATION OF NITROSYL IRON COMPLEXES

*Pokidova O.V.*<sup>1</sup>, *Emel'yanova N.S.*<sup>1</sup>, *Novikova V.O.*<sup>1</sup>, *Kulikov A.V.*<sup>1</sup>, *Sanina N.A.*<sup>1,2,3</sup>

<sup>1</sup> Federal Research Center of Problems of Chemical Physics and Medicinal Chemistry, Russian Academy of Sciences, Moscow region, Chernogolovka, Russia

<sup>2</sup> Lomonosov Moscow State University, Moscow, Russia

<sup>3</sup> Scientific and Educational Center "Medical Chemistry" in Chernogolovka, Federal State Autonomous Educational Institution of Higher Education "State University of Education", Moscow Region, Mytishchi, Russia

Leading Researcher, PhD

[pov@icp.ac.ru](mailto:pov@icp.ac.ru)

NO is a unique signaling molecule involved in the regulation of cardiovascular tone, apoptosis, immune defense, and neural transmission [1]. Due to the discovery of the fundamental role of nitrosyl iron complexes (NICs) as natural NO carriers, their synthetic analogs are of considerable interest as promising prodrugs for the treatment of socially significant diseases [2].

We have investigated NICs with aliphatic and aromatic thiolate ligands, viz.  $[\text{Fe}(\text{SC}(\text{NH}_2)_2)_2(\text{NO})_2]\text{Cl}\cdot\text{H}_2\text{O}$ ,  $[\text{Fe}(\text{SC}(\text{NH}_2)(\text{NHC}_2\text{H}_5))_2(\text{NO})_2]\text{Cl}\cdot[\text{Fe}(\text{SC}(\text{NH}_2)(\text{NHC}_2\text{H}_5))\text{Cl}(\text{NO})_2]$ ,  $[\text{Fe}_2(\text{S}(\text{C}(\text{CH}_3)_2\text{CH}(\text{NH}_3)\text{COOH}))_2(\text{NO})_4]\text{SO}_4\cdot 5\text{H}_2\text{O}$ ,  $\text{Na}_2[\text{Fe}_2(\text{S}_2\text{O}_3)_2(\text{NO})_4]\cdot 4\text{H}_2\text{O}$ ,  $[\text{Fe}_2(\text{C}_7\text{H}_7\text{OS})_2(\text{NO})_4]$ ,  $[\text{Fe}_2(\text{C}_8\text{H}_8\text{NOS})_2(\text{NO})_4]$ , etc.. These complexes, in addition to vasodilator properties, in *in vitro* studies, depending on the structure of the ligand, demonstrated cytotoxic, antimetastatic, antidiabetic, antibacterial, and other activities [3-5].

The purpose of this work was to study the mechanisms of interaction of these promising complexes with bovine serum albumin (BSA) and reduced glutathione (GSH) in aqueous solutions by experimental and theoretical methods.

It was shown that the NICs react with GSH to form a new binuclear NIC with two GS- ligands. The resulting complex is a more prolonged NO donor than the initial ones. The complex with 4-acetamidothiophenyls is an exception; in it, the ligands are not replaced by glutathione.

It was found that the products of aerobic decomposition of NICs with aliphatic ligands,  $[\text{Fe}(\text{NO})_2]^+$  fragments, can bind in the hydrophobic pocket of the albumin. Because of this interaction, a high molecular weight complex is formed with Cys34 and His39 as ligands. For most of the studied NICs with aromatic ligands, we do not observe the formation of this product. However, all complexes are adsorbed on the surface due to weak intermolecular interactions, resulting in prolonged generation of NO. It is important to note that complexes with aromatic thioligands generate NO in these systems more slowly than aliphatic NICs. EPR- and UV spectroscopy data also confirm significant stabilization of complexes in the reaction mixture with protein.

In experiments on animals, the EPR signal in the blood is given by the dinitrosyl iron fragment bound to albumin, which indicates its active participation in the biotransformation of nitrosyl complexes. We assume that NICs formed in the model systems are the pharmacologically active forms of original complexes in the body.

## References

- [1] *Chem. Rev.* **2021**, 121, 14682
- [2] *Nitric Oxide* **2016**, 54, 15
- [3] *J. Coord. Chem.* **2016**, 69, 812-825
- [4] *Front. Pharmacol.* **2019**, 10, 1277
- [5] *Membranes* **2023**, 13, 615

## Acknowledgements

The study of the biotransformation of complexes with aromatic thiolate ligands was supported by Russian Science Foundation grant No. 22-73-10049, <https://rscf.ru/project/22-73-10049/>, with aliphatic thiolate ligands- in accordance with the state task, state registration No 124020500019-2.

# PYRAZINOPORPHYRINS – PROSPECTIVE BASIS FOR HETEROGENEOUS OXIDATION PHOTOCATALYSTS

*Polivanovskaia D.A.<sup>1</sup>, Birin K.P.<sup>1</sup>, Senchikhin I.N.<sup>1</sup>, Demina L.I.<sup>1,2</sup>, Tsivadze A.Yu.<sup>1</sup>*

<sup>1</sup> Frumkin Institute of Physical Chemistry and Electrochemistry RAS, Moscow, Russia

<sup>2</sup> Kurnakov Institute of General and Inorganic Chemistry RAS, Moscow, Russia

Young Scientist, Dr.

[dpolivanovskaya@mail.ru](mailto:dpolivanovskaya@mail.ru)

The ability for photoinitiated generation of reactive oxygen species determines the use of porphyrins as photosensitizers for various applications. Our recent studies have demonstrated the exceptional photocatalytic activity of pyrazinoporphyryns in the oxidation of organic sulfides [1-2]. It was shown that targeted functionalization allows to control the photocatalytic activity and photostability of pyrazinoporphyryns. The introduction of electron-withdrawing groups and heavy metal atoms might increase the efficiency of porphyrins in photocatalysis. The resulting phosphonate-substituted In(III) porphyrinates showed significantly higher photocatalytic activity in the oxidation of thioanisole with TON reaching 200000 and TOF ca. 12500 h<sup>-1</sup> (Figure 1), which is one of the highest values for photosensitizers, reported so far.

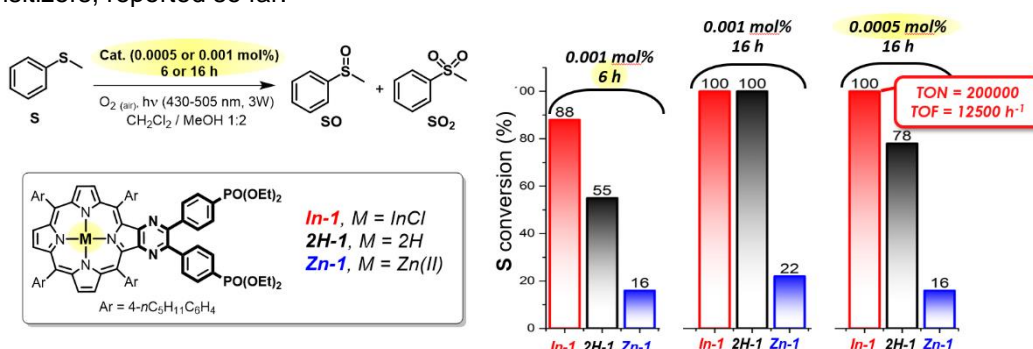

**Figure 1.** Photocatalytic activity of phosphonate-substituted pyrazinoporphyryns in solution.

In(III) porphyrinate was used for the preparation of photoactive hybrid material (13 mass% of porphyrin) through immobilizing the macrocycle onto mesoporous titania (Scheme 1). Initial experiments on the photooxidation of thioanisole showed the preservation of the photocatalytic activity of the material. The use of <0.015 mol% of the prepared heterogeneous photocatalyst provided complete and selective conversion of thioanisole (Scheme 1). TON of catalyst exceeded 7000, which is also one of the highest value among photoactive hybrids of this type.

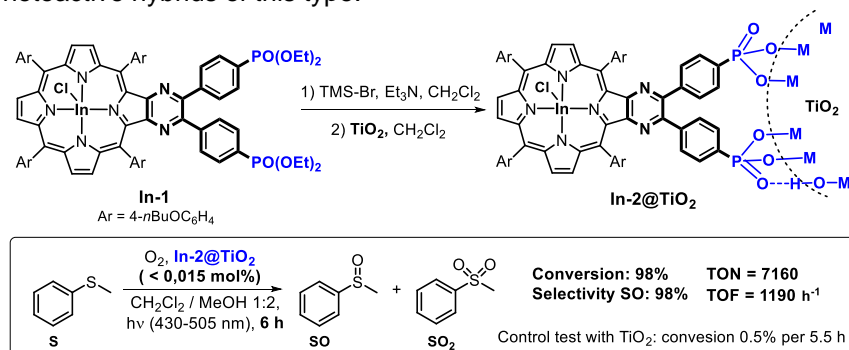

**Scheme 1.** Preparation of photoactive pyrazinoporphyrin-coated TiO<sub>2</sub> and its photocatalytic activity under heterogeneous conditions.

Thus, the functionalized pyrazinoporphyryns are expected to be an attractive platform for the development of new effective heterogeneous photocatalysts.

## References

- [1] *J. Cat.* **2022**, *413*, 342–352  
 [2] *Dyes Pigm.* **2023**, *210*, 110935

## Acknowledgements

This work was supported by the Russian Science Foundation (project No 23-23-00542).

# FUNCTIONALIZED OXAZOLE DERIVATIVES: UNEXPECTED REACTIONS AND EFFECTS

*Poltavtsev I.D.*<sup>1,2</sup>, *Kouame E.K.*<sup>1,2</sup>, *Ushakov I.A.*<sup>2</sup>, *Lysenko K.A.*<sup>3</sup>, *Lvov A.G.*<sup>1,2</sup>

<sup>1</sup> Irkutsk National Research University, Irkutsk, Russia

<sup>2</sup> A.E. Favorsky Irkutsk Institute of Chemistry, Irkutsk, Russia

<sup>3</sup> Lomonov Moscow State University, Moscow, Russia

Student, Bachelor

[igor.poltavtsev129@mail.ru](mailto:igor.poltavtsev129@mail.ru)

Photochromic diarylethenes continue to attract the attention due to the versatility and diversity of their photochemical reactions, as well as unexpected findings accompanying the corresponding studies [1]. In our work, we investigate the synthesis and light-induced transformations of oxazole-based diarylethenes as promising and readily available photoswitches.

We have synthesized previously unknown oxazole-substituted 2,3-dihetarylbut-2-enes, which exhibit an efficient photoswitching associated with reversible 6 $\pi$ -cyclization and cycloreversion. These compounds can be readily prepared from acetyl-substituted oxazoles *via* the McMurry reaction in the presence of low-valent titanium. For some of them, such as **2**, we have found an interesting “self-tuning” effect of the switched system. Although **2** is formed as a mixture of *E*-/*Z*-isomers, its irradiation with UV light leads to the almost quantitative conversion to **2c** and, after irradiation with visible light, to *Z*-**2**. The latter participates in the photochromic switching without the contribution of side *Z*-/*E*-isomerization. Up to date, this effect has not been described previously.

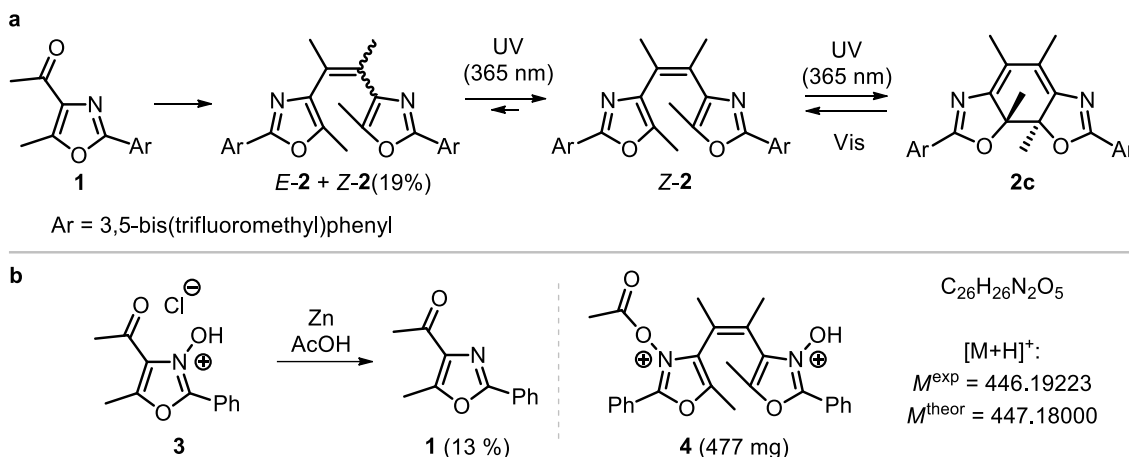

**Scheme 1.** Reactions of oxazole derivatives.

Another unexpected result was found during reduction of oxazole *N*-oxide **3** with zinc according to the method [2]. When the reaction temperature exceeded 15 °C, the formation of several side products with strong fluorescence along with the expected product **1** was observed. For one of them, structure **4** was proposed based on NMR spectroscopy and mass spectrometry. The mechanism for the formation of compound **4** will be discussed.

## References

- [1] *Chem. Rev.*, **2014**, 114, 24, 12174-12277  
 [2] *J. Chem. Soc. C*, **1968**, 1397-1399

## Acknowledgements

This work was supported by the Ministry of Science and Higher Education the framework of Scientific and Educational Center «Baikal» (FZZS-2024-0001).



## MULTICOMPONENT CRYSTALS BASED ON FAVIPRAVIR

*Posypayko E.E.<sup>1</sup>, Buikin P.A.<sup>1</sup>, Korlyukov A.A.<sup>1</sup>*

<sup>1</sup> A. N. Nesmeyanov Institute of Organoelement compounds Russian Academy of Sciences, Moscow, Russia  
Student  
[lizapos2003@gmail.com](mailto:lizapos2003@gmail.com)

Favipiravir is proved to be effective agent for treatment of COVID-19. The synthesis of new cocrystals or polymorphs [1] is useful for the development of new pharmaceutical forms. Previously, several cocrystals of 6-fluoro-3-hydroxypyrazine-2-carboxamide (favipiravir) with GRAS cofomers were reported [2]. In this research, we have chosen flat basic aromatic substances instead of acidic ones used in [2] to be the cofomers such as 4-aminopyridine and 2-pyridone. As a result, five cocrystals were discovered and studied using X-ray diffraction, TGA and DSC.

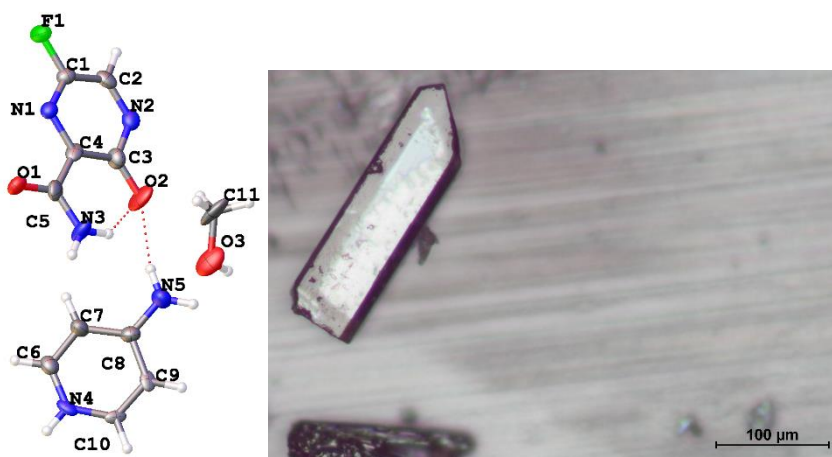

**Scheme 1.** Fragment of the crystal structure and snapshot of the crystal for the cocrystal of Favipiravir and 4-aminopyridine in methanol.

Four cocrystals were synthesized due to interaction of favipiravir and 4-aminopyridine (1:1) in various solvents. Crystals containing two independent molecules of Favipiravir, 4-aminopyridine and water in  $P2_1/c$  were crystallized from ethanol. Adding acetone allows crystallization in  $Cc$  cell containing three independent molecules of Favipiravir, 4-aminopyridine and four molecules of water.

The usage of methanol as solvent lead to crystallization of the compound in the orthorhombic  $Pnc2$  cell consisting of Favipiravir, 4-aminopyridine and methanol molecules (scheme 1). The structure containing two molecules of Favipiravir, one molecule of  $CH_3CN$  and 4-aminopyridine was crystallized in orthorhombic  $Pna2_1$  from acetonitrile.

A cocrystal of favipiravir and 2-pyridone (1:1) was obtained by recrystallization from ethanol in a monoclinic  $P2_1/c$  cell. Due to strong  $NH(\text{pyridine}) \cdots O(\text{amide})$  and  $NH_2(\text{amide}) \cdots O(\text{pyridone})$  hydrogen bonds, tetramers are formed. Crystallization from mixture of toluene and ethanol (1:1) results in formation of cocrystal in triclinic  $P-1$  cell containing one molecule of Favipiravir and 2-pyridone.

The stability of favipiravir-based multicomponent crystals could be achieved via combination of hydrogen bonding and stacking interactions. The main types of intermolecular interactions were characterized using quantum chemical calculations, also the thermodynamic stability of all synthesized compounds was studied.

### References

- [1] *Pharmaceutics* **2021**, 13(2), 139  
[2] *Cryst. Growth Des.* **2021**, 21(8), 4417–4425

### Acknowledgements

This work was supported by the Russian Science Foundation (project No 20-13-00241).

# THE CONSTRUCTION OF SPIRO[1-AZABICYCLO[3.2.0]HEPTANE] FRAMEWORKS VIA 1,3-DIPOLAR CYCLOADDITION

*Pronina Yu.A.*<sup>1</sup>, *Boitsov V.M.*<sup>2</sup>, *Stepakov A.V.*<sup>3</sup>

<sup>1</sup> St. Petersburg State Institute of Technology, St. Petersburg, Russia

<sup>2</sup> Alferov University, Russia

<sup>3</sup> St. Petersburg State University, St. Petersburg, Russia

Student

[pronina.iuli05@yandex.ru](mailto:pronina.iuli05@yandex.ru)

Development of efficient approach to synthesis of oxindoles spiro-fused with bicyclic framework 1-azabicyclo[3.2.0]heptane is promising direction of research. 1-Azabicyclo[3.2.0]heptane is the structural basis of carbopenem antibiotics, which have been widely used in medicine over the last decade [1]. And oxindole frameworks are found in a wide range of natural substances and pharmacological products [2].

We have developed the first example of diastereo- and regioselective [3+2]-cycloaddition reaction of azomethine ylides generated *in situ* from isatins and azetidine-2-carboxylic acid to *N*-maleimides and *N*-itaconimides. As part of the study, the effect of *N*-maleimides and *N*-itaconimides with different electronic and spatial properties, as well as the effect of substituents in the structure of isatin on the efficiency of the reaction, was investigated. The reactions were carried out to obtain products with moderate or high yields (up to 93%), with moderate or excellent diastereoselectivity and excellent regioselectivity. Compounds relative configuration was determined by single crystal X-ray analysis.

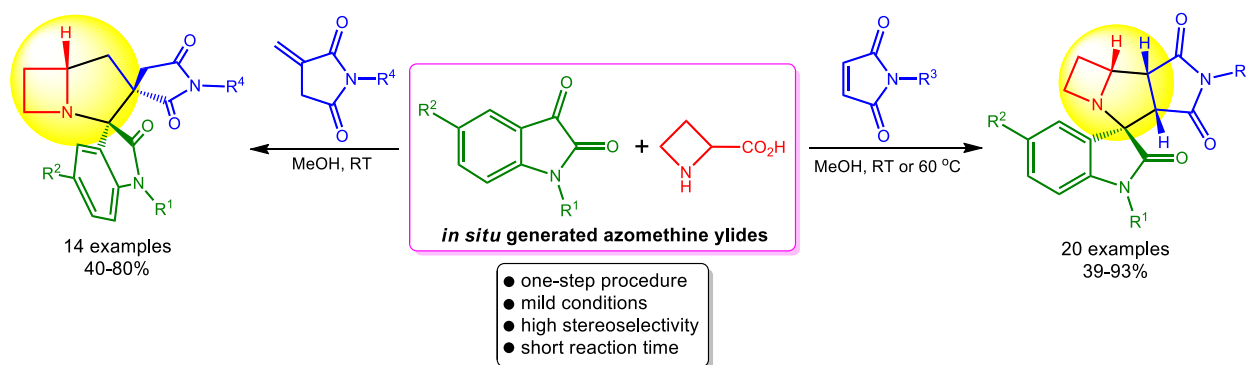

**Scheme 1.** Synthesis 1-azabicyclo[3.2.0]heptane-derivatives.

The obtained products were examined for cytotoxic activity using a standard MTS-analysis, during which some compounds showed a comparable or stronger inhibitory effect ( $IC_{50} = 8-20 \mu\text{g/mL}$ ) compared with cisplatin ( $IC_{50} = 15-45 \mu\text{g/mL}$ ) against human leukemia cells (K562). The presented efficient synthesis protocol can potentially be used for medical chemistry.

## References

[1] *Acc. Chem. Res.* **2021**, 54, 2055

[2] *J. Med. Chem.* **2006**, 49, 3432

## Acknowledgements

This work was supported by the Ministry of Science and Higher Education of the Russian Federation (projects FSEN-2023-0002 and FSRM-2023-0005).

## SYNTHESIS OF THIOSULFINATES WITH ANTIMICROBIAL ACTIVITY

*Puchkov V.*<sup>1</sup>, *Koval V.*<sup>1</sup>, *Revtovich S.*<sup>1</sup>, *Lyfenko A.*<sup>1</sup>, *Morozova E.*<sup>1</sup>, *Solyev P.*<sup>1</sup>

<sup>1</sup> Engelhardt Institute of Molecular Biology of the Russian Academy of Sciences, Moscow, Russia.

Master's student

[noldor.9@yandex.ru](mailto:noldor.9@yandex.ru)

Prop-2-ene-1-thiosulfinate (Allicin) has an antimicrobial effect, including application to methicillin-resistant strains of *Staphylococcus aureus* [1,2]. Its non-selective effect on sulfur-containing proteins in pathogens is explained by the presence of the thiosulfinate group, which allows allicin to oxidize thiols and lowers the possibility of drug-resistance development. At the same time, the instability of allicin caused by the presence of the reactive allylic substituent prevents its application as an individual therapeutic agent. Thus, the search for new thiosulfinates with antibacterial and antifungal properties as alternative drugs can be considered relevant.

We have synthesized a number of natural dialkylthiosulfinates, as well as synthetic derivatives of dialkyldicarboxylates and a representative of diarylthiosulfinates (Scheme 1).

Halogenated alcohols were chosen for ester substituents based on the expectation of improved stability of the corresponding disulfides and thiosulfinates. The antimicrobial activity of the dialk(en)ylthiosulfinates and their synthetic analogues was assessed on *S. aureus* bacteria and *Candida albicans* fungus. It was found that natural thiosulfinates were insufficiently active, while some of synthetic compounds demonstrated profound antifungal properties, effectively inhibiting the growth of *C. albicans* in low concentrations (2.78-20 μM) [3].

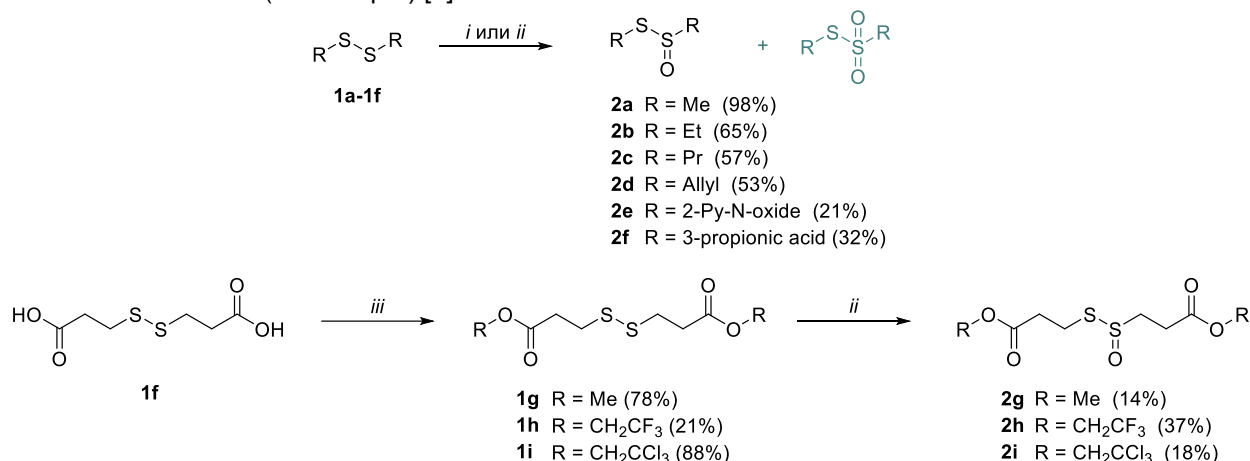

**Scheme 1.** Thiosulfinates synthesis. Reagents and conditions: (i) H<sub>2</sub>O<sub>2</sub>, HCOOH, 0°C; (ii) *m*-CPBA, CH<sub>2</sub>Cl<sub>2</sub>, -78° → 0°C; (iii) ROH, t, H<sub>2</sub>SO<sub>4</sub>.

We have also developed an improved method for selective disulfide oxidation into thiosulfinates, avoiding sulfones as byproducts. This new method significantly increased yields of thiosulfinates and allowed to omit column chromatography in some cases.

2,2,2-Trichloroethyl 3-({[3-oxo-3-(2,2,2-trichloroethoxy)propane]sulfinyl}sulfanyl)propanoate turned out to be the versatile promising drug candidate. Among all the obtained compounds it had the most expressed effect on both *S. aureus* and *C. albicans* strains, comparable to the drugs used in clinical practice.

### References

- [1] *Molecules* **2014**, *19*, 12591  
 [2] *Ann. med. health sci. res.* **2014**, *4*, 863  
 [3] *Mol. Biol.* **2024**, *58*, in press

### Acknowledgements

This work was supported by the Russian Science Foundation (project № 23-24-00151).

## MOLECULAR DESIGN AND SYNTHESIS OF SPIROPYRAN FLUORESCENT PROBES

*Pugachev A.D.*<sup>1</sup>, *Kozlenko A.S.*<sup>1</sup>, *Ozhogin I.V.*<sup>1</sup>, *Makarova N.I.*<sup>1</sup>, *Rostovtseva I.A.*<sup>1</sup>, *Sazykina M.A.*<sup>1</sup>,  
*Sazykin I.S.*<sup>1</sup>, *Matukhno A.E.*<sup>1</sup>, *Ponyatovskaya A.M.*<sup>1</sup>, *Borodkin G.S.*<sup>1</sup>

<sup>1</sup> Southern Federal University, Rostov-on-Don, Russia

Young Scientist, PhD

[apugachev@sfedu.ru](mailto:apugachev@sfedu.ru)

Spiropyrans are one of the most interesting classes of organic photochromes [1]. They are characterized by reversible isomerization under the influence of activating radiation (usually UV) between the colorless spirocyclic and brightly colored merocyanine forms, which is accompanied by an extremely sharp change in properties. A distinctive feature of spiropyrans is a sharp change in the dipole moment of the molecule and fluorescent properties after phototransformation. As a rule, the maximum wavelengths of absorption and photoluminescence of spiropyrans lie in the region of 300 – 600 nm.

When conducting bioimaging studies in the visible range, there is a significant drawback - a small penetration depth (about 100  $\mu\text{m}$ ). However, in the wavelength range of the "biological window" (650 – 1350 nm) it can already reach 1–2 cm. This became possible due to an increase in the length conjugation chains by introducing a vinyl-3*H*-indolium substituent [2, 3]. In this study, a series of compounds were synthesized (Figure 1, left). The structure of the compounds was confirmed by NMR methods (Center for Collective Use "Molecular Spectroscopy of the Southern Federal University"). The fluorescence photoswitching diagram of one of spiropyrans is shown in Figure 1 (middle). A toxicity study was carried out using *lux*-biosensors and biofilms. As a result, the selected compounds were successfully applied to visualize *E. coli* bacteria (Figure 1, right).

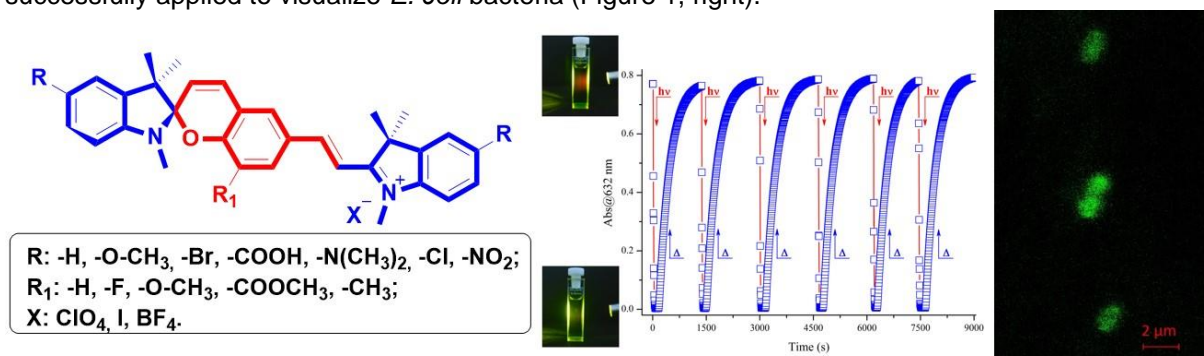

**Figure 1.** Structure of synthesized compounds, demonstration fluorescence "On-Off" cycles and visualisation of bacteria *E. Coli* using microscope.

Bioimaging procedures were carried out using ZEISS LSM 880 microscope. The authors express their gratitude to the Southern Federal University Strategic Academic Leadership Program ("Priority 2030") for providing an experimental base for conducting research.

### References

- [1] *Top. Curr. Chem.* **2023**, 381, 8
- [2] *Photochem. Photobiol. Sci.* **2023**, 22, 2651
- [3] *ChemistrySelect*, **2024**, 9, e202400058

### Acknowledgements

This work was supported by the Ministry of Science and Higher Education of the Russian Federation; project FENW-2023-0020.

# INTERMOLECULAR GOLD-CATALYZED N-TRANSFER INVOLVING ARYLAZIDES: A ROUTE TO FUNCTIONALIZED 2-AMINOINDOLES.

*Puskov G.I., Dubovtsev A. Yu.*

St. Petersburg State University, St. Petersburg, Russia

Student

[st075510@student.spbu.ru](mailto:st075510@student.spbu.ru)

In the past decade, gold-based catalysts have demonstrated the effectiveness for a wide range of chemical transformations [1]. Specifically, gold-catalyzed nitrene transfer reactions (N-transfers) provide a diverse array of pharmacologically relevant nitrogen-containing heterocyclic compounds [2].

Gold-catalyzed reactions involving alkylazides as N-transfer reagents have been extensively studied [3]. At the same time, arylazides have not been previously used in relevant intermolecular reactions [4]. In this work, we demonstrate for the first time that arylazides can act as effective N-transfer reagents under gold-catalyzed conditions. Based on this finding, a new approach to functionalized 2-aminoindoles has been developed.

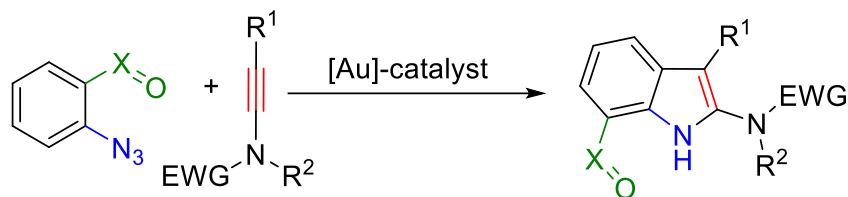

X = CH, CAIk, CAr, NO

EWG = Acyl, SO<sub>2</sub>R

**Scheme 1.** Intermolecular Au-catalyzed N-transfer involving arylazides.  
Synthesis of functionalized 2-aminoindoles.

## References

- [1] *Chem. Rev.* **2015**, *17*, 115
- [2] *Chem. Rev.* **2021**, *14*, 121
- [3] *Org. Lett.* **2016**, *18*, 18
- [4] *Chem. Eur. J.* **2020**, *15*, 26

## Acknowledgements

This work was supported by the Russian Science Foundation (project No 23-73-10008).

# HALONIUM AND CHALCONIUM SALTS AS NONCOVALENT ORGANOCATALYSTS FOR ELECTROPHILIC ACTIVATION OF CARBONYL COMPOUNDS

Putnin I.O., Sysoeva A.A.

St. Petersburg State University, St. Petersburg, Russia

1<sup>st</sup> Year Master's Student

[st117584@student.spbu.ru](mailto:st117584@student.spbu.ru)

Electrophilic activation of the carbonyl group is of great significance and widely used approach in modern organic synthesis. When classical Lewis acids such as metal-complex catalysts are used in these reactions, the metal electrophilically activates the carbonyl group making it a more convenient target for nucleophilic attack. Even though the entropy of activation ( $\Delta S^\ddagger$ ) of this reaction takes a more negative value due to the addition of the catalyst to the reaction substrate, the enthalpy of activation ( $\Delta H^\ddagger$ ) decreases more strongly due to the electrophilic activation of the carbonyl group, and therefore the reaction is accelerated.

In this study, we investigated the kinetics of the reaction of *para*-methylbenzaldehyde with aniline catalyzed by organic Lewis acids, namely telluronium ( $\text{Te}^{\text{IV}}$ ) and iodonium ( $\text{I}^{\text{III}}$ ) salts. Based on the obtained activation parameters ( $\Delta S^\ddagger$ ,  $\Delta H^\ddagger$ ), plausible mechanisms of the model reaction involving  $\text{Te}^{\text{IV}}$  and  $\text{I}^{\text{III}}$  have been suggested (**Scheme 1**).

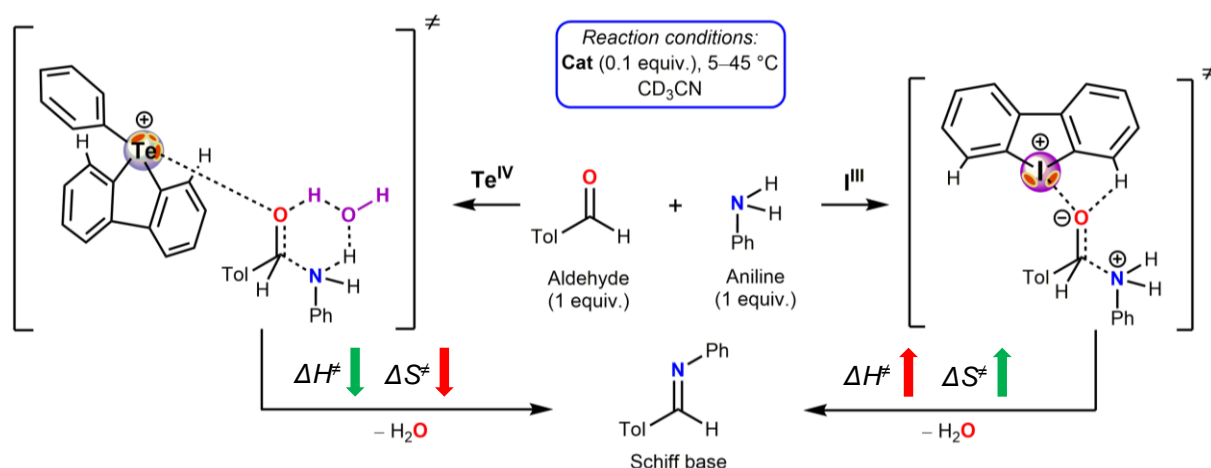

**Scheme 1.** Plausible mechanisms of the model reaction.

Based on the results of the conducted experiments, a number of thermodynamic and kinetic parameters of the reaction were calculated, including the  $\Delta S^\ddagger$  values [ $\text{kJ mol}^{-1} \text{K}^{-1}$ ] and  $\Delta H^\ddagger$  [ $\text{kJ mol}^{-1}$ ] for the non-catalyzed reaction [ $-0.262(3)$ ;  $19(1)$ ], for the reaction catalyzed by  $\text{Te}^{\text{IV}}$  [ $-0.284(4)$ ;  $8(1)$ ] and  $\text{I}^{\text{III}}$  [ $-0.224(1)$ ;  $22.9(1)$ ]. The kinetic data indicated that the catalytic effect of  $\text{Te}^{\text{IV}}$  is provided via decrease of  $\Delta H^\ddagger$  of the reaction. This indicates a classical mechanism of electrophilic activation of the carbonyl group through the formation of a chalconium bond under additional coordination by a water molecule. The catalytic effect of  $\text{I}^{\text{III}}$  unexpectedly was caused by decrease of the  $\Delta S^\ddagger$  absolute value. We assume that the reaction involving  $\text{I}^{\text{III}}$  proceeds through the formation of a zwitter-ionic transition state, the smaller stability and size of which increase  $\Delta S^\ddagger$  and  $\Delta H^\ddagger$ .

The data obtained on the kinetics of the model reaction make it possible to optimally select conditions for reactions involving carbonyl group catalyzed by chalconium and halonium salts. This study contributes to the theoretical understanding of mechanisms underlying electrophilic activation reactions.

## Acknowledgements

This work was supported by the Russian Science Foundation (project No 23-73-10003; kinetic study) and Saint Petersburg State University (project No 103922061; synthetic work). Physicochemical studies were performed at the Center for Magnetic Resonance, Chemistry Educational Centre, and Center for Chemical Analysis and Materials Research (all at St. Petersburg State University).

# REACTIONS OF LEVULINIC ACID WITH ARENES UNDER SUPERELECTROPHILIC ACTIVATION

*Puzanov A.I.<sup>1,2</sup>, Vasilyev A.V.<sup>2</sup>*

<sup>1</sup> Ufa State Petroleum Technical University, Ufa, Russia

<sup>2</sup> Saint Petersburg State Forest Technical University, Saint Petersburg, Russia

Postgraduate

[apuzanov21@mail.ru](mailto:apuzanov21@mail.ru)

Levulinic acid is obtained from hexoses under the action of dilute mineral acids. It is a promising molecule for the preparation of new organic compounds.

The aim of this work was to obtain products of acylation of arenes with levulinic acid **1** under the action of Brønsted and Lewis acids, leading to the formation of diketones **2** or 4-methyl-4-aryl-tetralones **3**.

The reaction of levulinic acid **1** with arenes under the action of strong Lewis acid AlCl<sub>3</sub> results in the formation of acylation products, namely 1-arylpentane-1,4-diones (diketones) **2**.

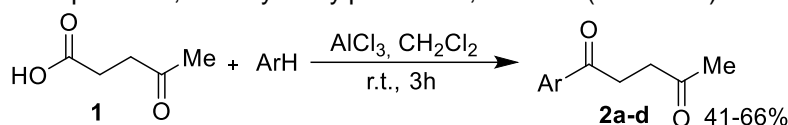

Ar=C<sub>6</sub>H<sub>n</sub>R: R= H(**a**, 66%), 3,4-Me<sub>2</sub> (**b**, 47%), 3,5-Me<sub>2</sub> (**c**, 41%), 2,4-Me<sub>2</sub> (**d**, 44%)

**Scheme 1.** Acylation of arenes by levulinic acid under the action of AlCl<sub>3</sub>.

Additionally, some diketones **2** can be obtained by reaction of levulinic acid **1** with arenes under the action of Brønsted superacid CF<sub>3</sub>SO<sub>3</sub>H (TfOH).

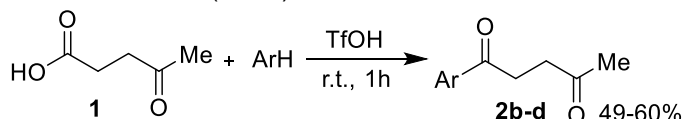

Ar=C<sub>6</sub>H<sub>n</sub>R: R= 3,4-Me<sub>2</sub> (**b**, 49%), 3,5-Me<sub>2</sub> (**c**, 51%), 2,4-Me<sub>2</sub> (**d**, 60%)

**Scheme 2.** Acylation of arenes by levulinic acid under the action of TfOH.

Interactions of levulinic acid **1** with arenes such as benzene, veratrole, and 2-fluoroanisole under the action of superacid TfOH lead to the formation of 4-methyl-4-aryl-tetralones **3**.

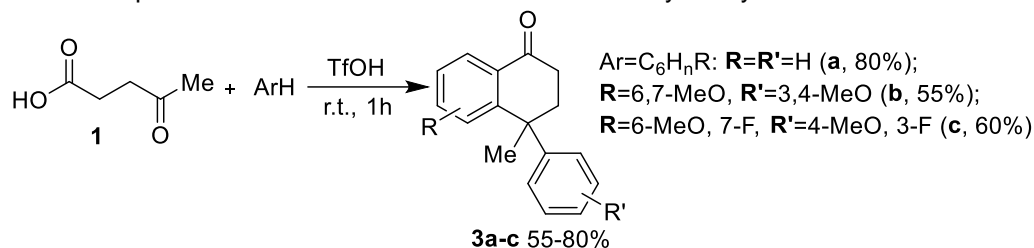

**Scheme 3.** Formation of tetralones from levulinic acid and arenes in TfOH.

One may propose the following plausible reaction mechanism. Protonation of carbonyl oxygens in levulinic acid **1** affords dication **A**. Subsequent reaction of intermediate **A** with arenes leads species **B**, hydrolysis of the latter gives acylation products, diketones **2**. Cyclization of dication **B** results in the formation of intermediate **C**. Subsequent protonation of hydroxyl group in species **C** followed by dehydration furnishes dication **D**, which is further attacked by arene to generate cation **E**. The hydrolysis of **E** finally gives rise to tetralones **3**.

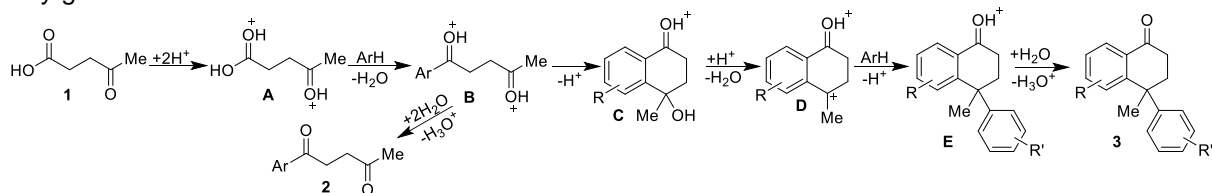

**Scheme 4.** Plausible reaction mechanism.

## N-H INSERTION REACTION OF DIAZO COMPOUNDS IN TETRAZOLES

*Radiupov V.E.*<sup>1</sup>, *Nenova A.V.*<sup>1</sup>, *Kantin G.P.*, *Dar'in D.V.*

<sup>1</sup> St. Petersburg State University, St. Petersburg, Russia

Student

[vradyupov@mail.ru](mailto:vradyupov@mail.ru)

Tetrazoles are among essential scaffolds in medicinal chemistry since they play a significant role as bioisosteric analogues of amide and carboxylic groups. Tetrazole derivatives perform various biological activities. There are a lot of examples of drugs containing tetrazole moiety [1]. Thus, the development of new effective methods for obtaining structurally diverse tetrazole derivatives is an important problem in organic and medicinal chemistry.

One of the valuable ways to obtain *N*-substituted heterocyclic derivatives is to apply the N-H insertion reaction involving diazo reagents [2]. To our knowledge, this reaction has not been reported for tetrazoles yet. The key aim of this research is to study the synthetic potential of the insertion of diazo compounds into N-H bond of tetrazoles.

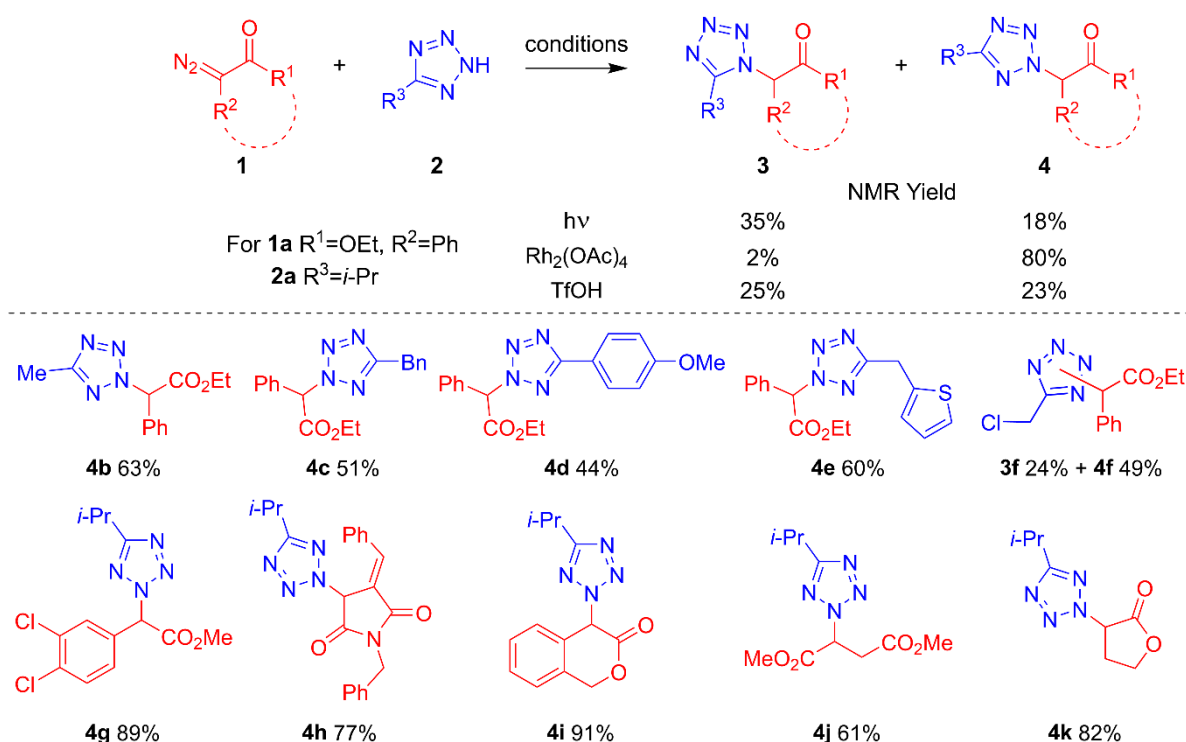

**Scheme 1.** Optimal conditions selection and examples of products obtained.

Primarily, we examined the scope of catalysts in the model reaction **1a+2a** and found Rh<sub>2</sub>(OAc)<sub>4</sub> to give almost exclusively *N*(2)-regioisomer. Interestingly, TfOH treatment yields the mixture of regioisomers with almost equal ratio, although LED-lamp initiating gives twice *N*(1)-regioisomer excess. The latter opens up opportunities for *N*(1)-substituted tetrazoles production, which allows for intramolecular cyclizations.

Then we used 2-diazo-2-phenylacetate **1a** in N-H insertion reaction of diversely substituted tetrazoles. In most cases, *N*(2)-isomer **4b-f** is the major one when catalyzing with Rh<sub>2</sub>(OAc)<sub>4</sub>. Also, we tested a variety of diazo compounds towards tetrazole **2a** and obtained *N*(2)-isomers **4g-k** in high yields.

All structures were confirmed by NMR spectroscopy. For **4i** X-ray analysis data was obtained.

### References

- [1] *Curr. Org. Chem.* **2021**, 25, 388-403  
 [2] *Chem. Heterocycl. Compd.* **2020**, 56(7), 809–813

### Acknowledgements

This work was supported by the Russian Science Foundation (project No 22-13-00005).



THE CONCEPT OF "ANTI-MOF".  
STRUCTURAL FEATURES OF HEXAMETHYL-[1,1'-BIPHENYL]- 4,4'-DIAMMONIUM SALTS

*Rajakumar K.<sup>1</sup>, Osipov A.A.<sup>1</sup>, Efremov A.N.<sup>1</sup>, Zherebtsov D.A.<sup>1</sup>, Nayfert S.A.<sup>1</sup>*

<sup>1</sup> South Ural State University, Chelyabinsk, Russia

PhD

[kumarkraja84@gmail.com](mailto:kumarkraja84@gmail.com)

The 21st century was marked by the rapid development and study of metal-organic frameworks (MOFs). These compounds have found wide application as sorbents, catalysts, gas-sensitive membranes [1]. We proposed and tested the idea of "anti-MOF" (Scheme 1): the metal cation is replaced by an anion, and the rigid carboxylate dianion is replaced by a rigid dication. Hexamethyl-[1,1'-biphenyl]-4,4'-diammonium or hexamethylbenzidinium (HMB) was chosen as a such dication.

Crystals were grown by slow evaporation of solvent; seven HMB salts were investigated by X-ray diffraction analysis: 4'-(dimethylamino)-N,N,N-trimethyl-[1,1'-biphenyl]-4-ammonium iodide (**1**), HMB iodide (**2**), HMB triiodide (**3**), HMB succinate (**4**), HMB tetravanadate (**5**), HMB terephthalate (**6**), HMB perylene-3,4,9,10-tetracarboxylate (**7**).

According to the obtained results it was concluded that these seven compounds are not "anti-MOF" since it have relatively small number of solvent molecules and structures does not represent open channels. In presented structures it is observed alternated cationic and anionic layers (Scheme 2). One may consider the torsional angle between the planes of the phenylene rings as a criterion of cation packing stress, then the least stressed packing is characterized by the compound (**1**) (19.34(0)°), and the most tense packing has the compound (**4**) (39.24(0)°).

Most water content has HMB succinate. Still this compound do not related to coordination polymers. Coming soon are hexacyanoferrites of HMB, that have highly charged compact anions.

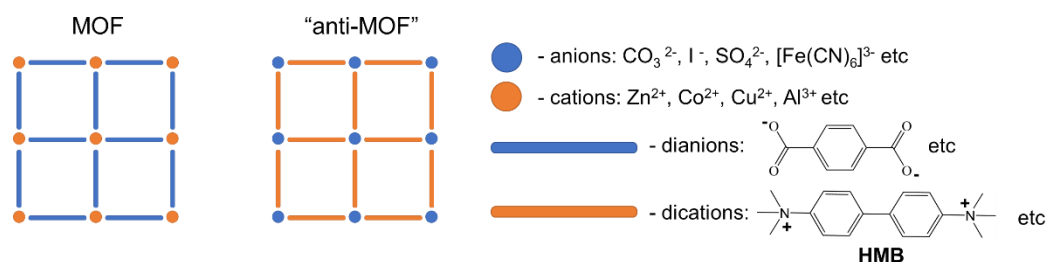

**Scheme 1.** Schematic of MOF and "anti-MOF" structures.

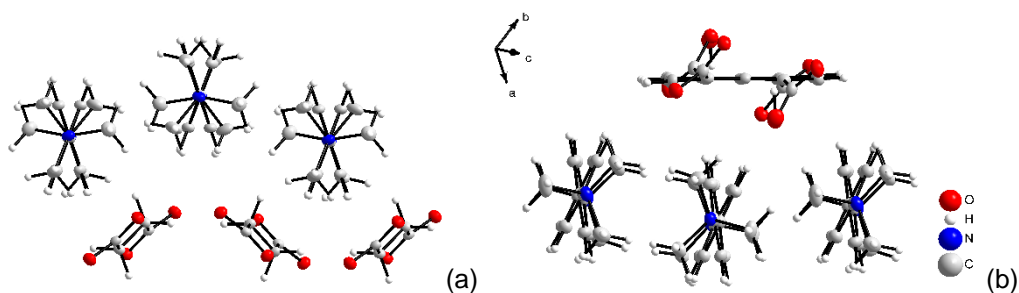

**Scheme 2.** Layered packing of ions in crystals **4** (a) and **7** (b).

### References

- [1] *Polymer International* **2017**, 66, 731  
 [2] *Nat. Rev. Methods Primers* **2023**, 3, 1  
 [3] *Angew. Chem., Int. Ed.* **2019**, 58, 11160

### Acknowledgements

This work was supported by the Russian Science Foundation (project No 23-13-00045).

# S-VINYL DERIVATIVES AS ACETYLENE SURROGATES IN THE SYNTHESIS OF PYRIDAZINES UNDER MICROWAVE ACTIVATION

*Reznichenko A.A.*<sup>1</sup>, *Reznichenko E.A.*<sup>1</sup>, *Ledovskaya M.S.*<sup>1</sup>, *Voronin V.V.*<sup>1</sup>

<sup>1</sup> St. Petersburg State University, St. Petersburg, Russia  
Student

[st106282@student.spbu.ru](mailto:st106282@student.spbu.ru)

The current research deals with the synthesis of 1,2,4,5-tetrazines and the study of their cycloaddition to vinyl sulfides under microwave and thermal activation in order to develop a new synthetic path for the construction of pyridazines. Pyridazines are an important class of heterocyclic compounds with great potential both in medicine and in organic and polymer chemistry, as well as in physics: such compounds demonstrate various biological activity, are used as ligands for the design of catalysts, and also exhibit interesting photophysical properties [1].

Calcium carbide easily transforms to vinyl derivatives. The latter can be used as acetylene surrogates for the construction of heterocyclic cores [2-4]. In this research, a two-step synthesis of 3,6-disubstituted pyridazines was performed. On the first step, various vinyl sulfides were synthesized from thiols and *in situ* generated acetylene. Further, [4+2] cycloaddition of 1,2,4,5-tetrazines to vinyl sulfides allowed to synthesize 3,6-disubstituted pyridazines (Scheme 1). Using this method a wide range of pyridazines was synthesized.

It was estimated that microwave activation can remarkably increase the product yield, as well as reduce the reaction time [2]. For example, under conventional heating the yield of 3,6-diphenylpyridazine was 73% in 24 days, while under microwave activation the yield was 93% in only 105 minutes.

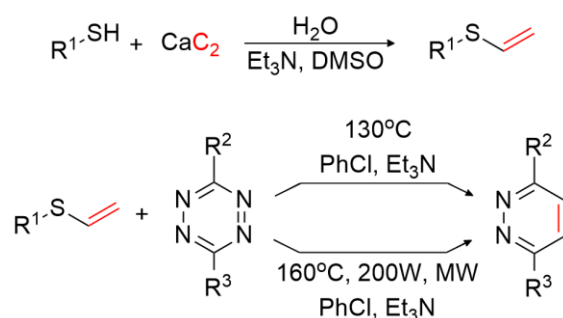

**Scheme 1.** S-vinyl derivatives as acetylene surrogate for the synthesis of pyridazines.

Keywords: calcium carbide, acetylene, vinylation, cycloaddition, pyridazines, microwave activation.

## References

- [1] *Russ. Chem. Rev.* **2020**, *89*, 393
- [2] *Eur. J. Org. Chem.* **2020**, *2020*, 4571
- [3] *Chin. J. Chem.* **2023**, *41*, 2810
- [4] *Chem. - An Asian J.* **2021**, *16*, 2286

## Acknowledgements

This work was supported by the Russian Science Foundation (project No 23-23-00203).

# CALCIUM CARBIDE IN TOTAL SYNTHESIS OF (HETERO)ARYL ACETYLENES

*Reznichenko E.A.*<sup>1</sup>, *Reznichenko A.A.*<sup>1</sup>, *Ledovskaya M.S.*<sup>1</sup>, *Voronin V.V.*<sup>1</sup>

<sup>1</sup> St. Petersburg State University, St. Petersburg, Russia

Student

[st106281@student.spbu.ru](mailto:st106281@student.spbu.ru)

Calcium carbide demonstrates high versatility in the synthesis of a wide variety of organic compounds [1]. The research of Sonogashira cross-coupling reactions involving halogen substituted polyheterocycles and *in situ* generated acetylene is of great interest to organic chemists, since the resulting products are suitable for the preparation of new fluorescent dyes.

In our work, calcium carbide was used for the construction of a number of heterocycle-containing acetylenes. On the first step, 1,3-dipolar cycloaddition and [4+2] cycloaddition of *in situ* generated acetylene was used for the synthesis of halogen-substituted heterocycles [2-6]. On the next step of our investigation, Pd-catalyzed cross-coupling reaction of acetylene and halogen-containing poly(hetero)aryl compounds allowed to synthesize (hetero)aryl acetylenes (Scheme 1).

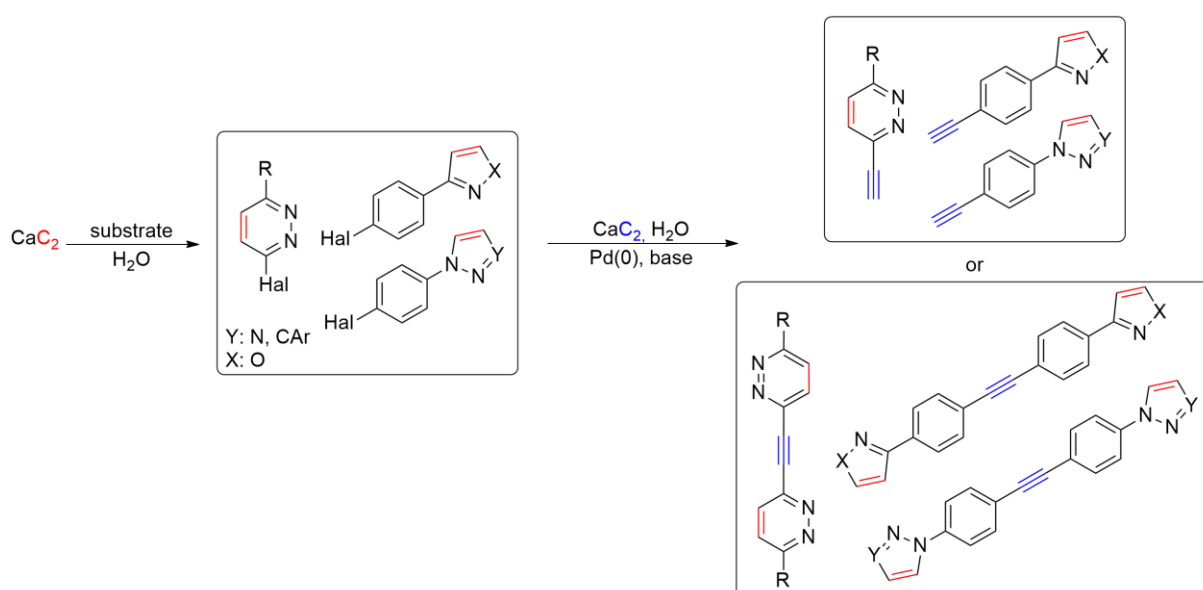

**Scheme 1.** The synthesis of (hetero)aryl acetylenes.

Keywords: calcium carbide, acetylene, cycloaddition, isoxazoles, pyrazoles, triazoles, pyridazines, Sonogashira coupling.

## References

- [1] *Tetrahedron* **2023**, 149, 133720
- [2] *Chin. J. Chem.* **2023**, 41, 2810
- [3] *Chem. Asian J.* **2021**, 16, 2286
- [4] *Eur. J. Org. Chem.* **2021**, 2021, 5640
- [5] *Org. Chem. Front.* **2018**, 5, 226
- [6] *J. Org. Chem.* **2018**, 83, 3819

## Acknowledgements

This work was supported by the Russian Science Foundation (project No 23-23-00203).

# PHOSPHORUS(III) COMPOUNDS AS REAGENTS FOR THE TRANSFORMATION OF 2-HALOAZIRINES

*Romanenko I.A., Novikov M.S.*

St. Petersburg State University, St. Petersburg, Russia

Bachelor student

[ilya\\_romanenko1528@mail.ru](mailto:ilya_romanenko1528@mail.ru)

2*H*-Azirines are widely used as versatile building blocks in the synthesis of 3–7-membered nitrogen heterocycles and various acyclic nitrogen-containing compounds [1]. 2-Halogen-substituted azirines, which exhibit unique reactivity towards nucleophiles, are of particular synthetic interest. In such reactions, these compounds can retain the azirine system [2] or undergo ring opening, ultimately leading to the formation of either new acyclic [3] or heterocyclic structures [4].

The application of the azirine strategy for the synthesis of heterocycles with phosphorus-containing functional groups comes down mainly to the use of hardly available azirinyolphosphonic esters and azirinyolphosphine oxides. In this work, the reactions of 2-bromo-2*H*-azirine-2-carboxylic acid derivatives with phosphites were studied as a more straightforward route to new heterocyclic systems with dialkoxyphosphoryl groups. It was found that azirine **1** reacts with trialkylphosphites when heated to form 2,4-bis(dialkoxyphosphoryl)-substituted 4-oxazolines **3** as main product. The data resulted from the experiments on <sup>1</sup>H NMR monitoring of the reaction course under various conditions and determining the structure of the by-products, allowed to suggest a six-step mechanism for this domino reaction. The opening of the three-membered ring occurs in betaine **2**, which is formed as a result of S<sub>N</sub>2' substitution of bromine, the Arbuzov reaction and the addition of a second phosphite molecule. The unexpected results of reactions of azirines **1** with triphenylphosphine, which proceeds through the formation of azirinyolphosphonium salts, are also discussed.

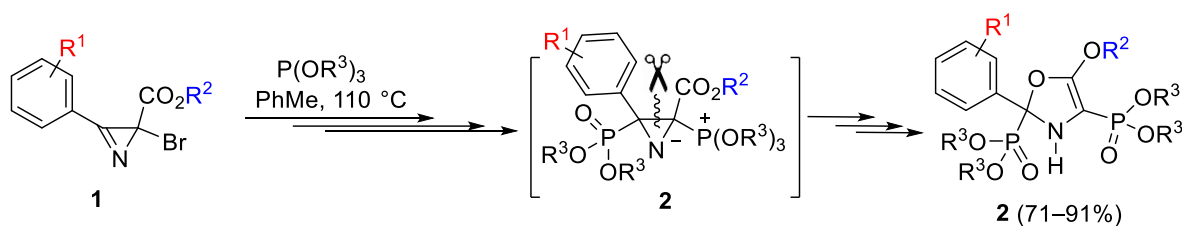

$R^1 = \text{H, 4-Me, 2,5-Me}_2, 4\text{-Cl, 4-Br, 4-MeO, 3,4-(MeO)}_2, 4\text{-CF}_3;$

$R^2 = \text{Me, Bn}; R^3 = \text{Me, Et.}$

**Scheme 1.** Synthesis of 2,4-bis(dialkoxyphosphoryl)-substituted 4-oxazolines.

## References

- [1] *Eur. J. Org. Chem.* **2024**, 27, e202301292
- [2] *J. Org. Chem.* **2018**, 83, 13473
- [3] *J. Org. Chem.* **2024**, 89, doi:10.1021/acs.joc.4c00264
- [4] *Org. Lett.* **2020**, 22, 3023

## Acknowledgements

This work was supported by the Russian Science Foundation (project No 23-13-00115). This research used recourses of the Magnetic Resonance Research Centre, Chemical Analysis and Materials Research Centre, and Centre for X-ray Diffraction Studies of St. Petersburg State University.

# RECEIVING AND APPLYING CLOSO-BORANE ANIONS AND NATURAL AMINO ACIDS IN BNCT

Ryabchikova M.N.<sup>1</sup>, Nelyubin A.V.<sup>2</sup>, Zhdanov A.P.<sup>2</sup>, Zhizin K.Yu.<sup>2</sup>

<sup>1</sup> National Research University Higher School of Economics, Moscow, Russia

<sup>2</sup> N.S. Kurnakov Institute of General and Inorganic Chemistry, Russian Academy of Sciences, Moscow, Russia

Student

[ryabchikovaarita@gmail.com](mailto:ryabchikovaarita@gmail.com)

<sup>10</sup>B-neutron-capture therapy (BNCT) is a promising method for the treatment of malignant tumors. Currently, the only drug authorized for use is *para*-boronophenylalanine. Its disadvantages are low mass fraction of boron atoms in the molecule, as well as low solubility of the drug in water. In the course of the work, we proposed the preparation of alternative candidate structures, selected the conditions for maximizing the yield, solved the problem of conflict of solubility of the reagents, and studied the kinetics of hydrolysis of the protecting groups. We have also developed a methodology to prepare amino acid conjugates with free carboxyl and amino groups and *closo*-dodecaborate anion, which is the first [B<sub>12</sub>H<sub>12</sub>]<sup>2-</sup> derived drug targeting the LAT-1 receptor of a cancer cell.

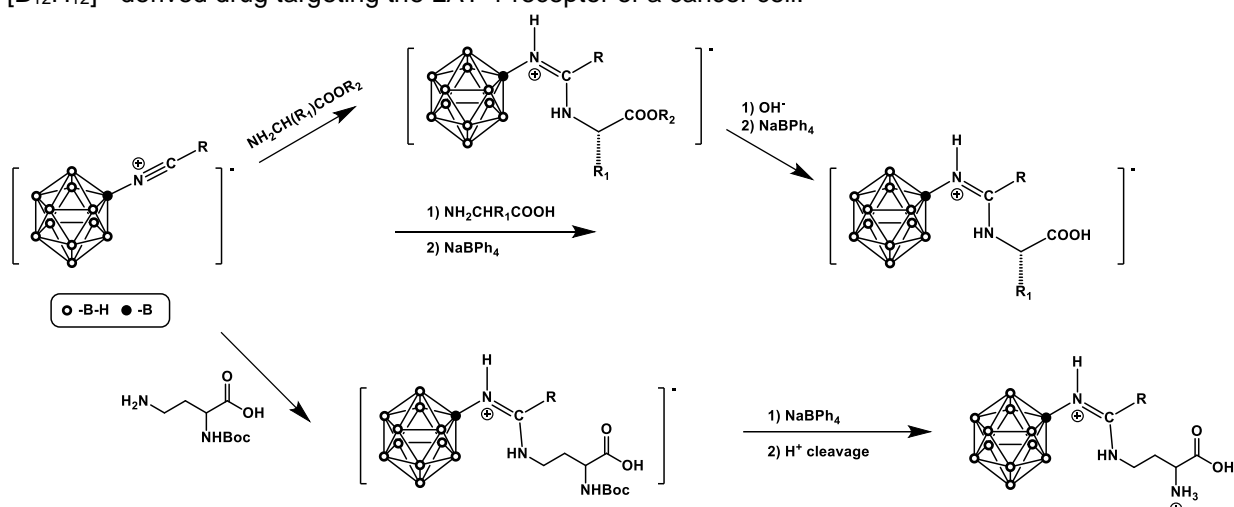

**Figure 1.** Scheme of preparation of conjugates of closo-borate anions and natural amino acids on the example of closo-dodecaborate anion. R = Me, <sup>n</sup>Pr; R<sub>1</sub> = H, Me, Bn, CH<sub>2</sub>OH, CH<sub>2</sub>SH, CH<sub>2</sub>Im, CH<sub>2</sub>COOH, CH<sub>2</sub>CONH<sub>2</sub>, 4-I-Bn; R<sub>2</sub> = Me, Et, <sup>t</sup>Bu, Bn.

Thus, conjugates of cluster anions [B<sub>12</sub>H<sub>12</sub>]<sup>2-</sup> and [B<sub>10</sub>H<sub>10</sub>]<sup>2-</sup>, with natural amino acids, as well as their halogen and ester derivatives were synthesized. The obtained substances were characterized by multinuclear NMR, IR spectroscopy, and high-resolution mass spectrometry. The kinetics of hydrolysis of the protecting groups was studied for derivatives of amino acids, and in vivo biodistribution data were obtained for conjugates of *closo*-dodecaborate anion with ethyl ester of glycine and phenylalanine.

## References

[1] *Russ. J. Inorg. Chem.* **2020**, 65(6), 795

## Acknowledgements

This work was supported by the Russian Science Foundation (project No 24-13-00295).

# ORGANOCATALYSIS BASED ON CHALCOGEN- AND HALOGEN-BOND-DONATING CYANOBORORHYDRIDES

*Safinskaya Y.V., Il'in M.V., Bolotin D.S.*

St. Petersburg State University, St. Petersburg, Russia

Student

[st095079@student.spbu.ru](mailto:st095079@student.spbu.ru)

In modern organic chemistry, organocatalysts based on donors of halogen and chalcogen bonds are widely used, because they have low toxicity, resistance to air components, and high catalytic activity in reactions requiring electrophilic activation (**Scheme 1**).

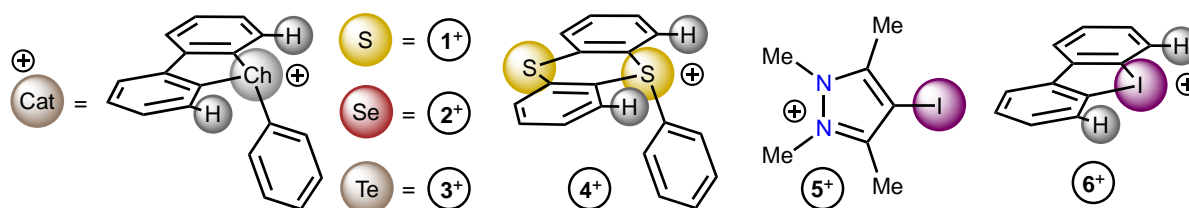

**Scheme 1.** Model donors of halogen and chalcogen bonds.

In this work [1], we have investigated the possibility of accelerating the hydrogenation reaction of an imino group with a cyanoborohydride anion, which is a part of the salt based on a  $\sigma$ -hole donating cation. Kinetic studies have shown that the reduction of a model imine is significantly accelerated in the presence of halogen and chalcogen bond donors compared to sodium and tetrabutylammonium cyanoborohydrides (**Scheme 2**).

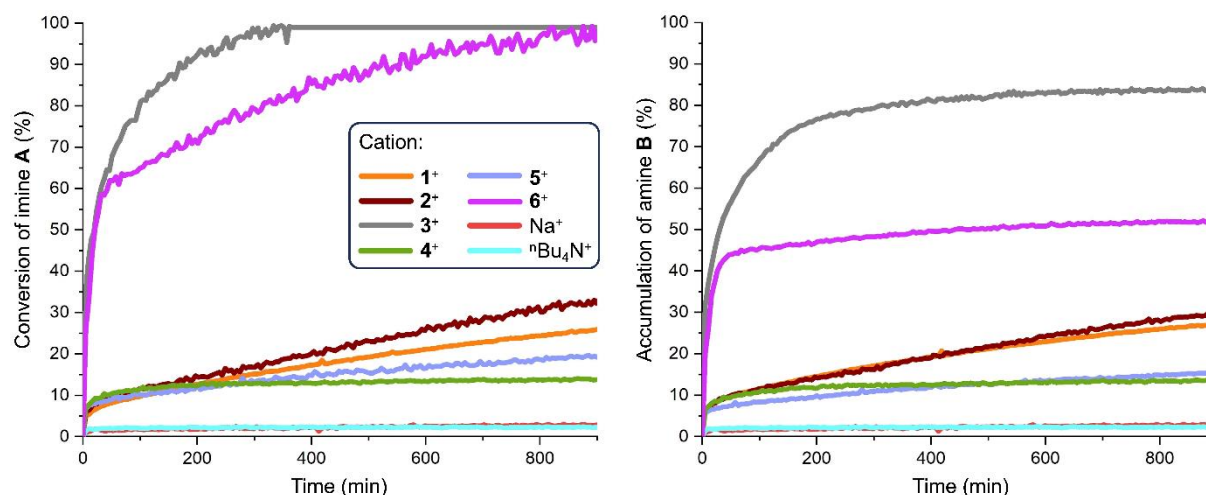

**Scheme 2.** Imine reduction kinetic curves based on  $^1\text{H}$  NMR monitoring.

## References

[1] *J. Org. Chem.* **2024**, *89*, 2916

## Acknowledgements

This work was supported by the Russian Science Foundation (project № 23-73-10003) and St. Petersburg State University (project № 103922061). The physicochemical studies were performed at the Center for Magnetic Resonance and Center for Chemical Analysis and Materials Research (all at Saint Petersburg State University).

# C–N COUPLING WITH DIARYLIODONIUM(III) SALTS: NEW APPROACH FOR SELECTIVE *N*-ARYLATION OF FIVE MEMBERED HETEROCYCLES

*Semenov A.V.*<sup>1</sup>, *Baykov S.V.*<sup>1</sup>, *Soldatova N.S.*<sup>2</sup>, *Postnikov P.S.*<sup>2</sup>, *Boyarskiy V.P.*<sup>1</sup>

<sup>1</sup> St. Petersburg State University, St. Petersburg, Russia

<sup>2</sup> Tomsk Polytechnic University, Tomsk, Russia

Postgraduate

[a.v.semenov@spbu.ru](mailto:a.v.semenov@spbu.ru)

Oxadiazole heterocycles are widely known as privileged structure in synthesis of pharmaceutically important compounds due to being bioisoster for carboxylic groups [1].

In course of our study dedicated to five membered heterocycles modification using iodonium compounds [2,3] we have developed new approach for selective *N*-arylation of 1,2,4- and 1,3,4-oxadiazolones with diaryliodonium salts in the present of Cu<sup>I</sup> catalyst (Figure 1) [3].

Further new synthetic pathway for obtaining the previously undescribed *N*-aryl-1,2,4-thiadiazol-5(4*H*)-ones – analogues of *N*-aryl-1,2,4-oxadiazol-5(4*H*)-ones was developed in our research group.

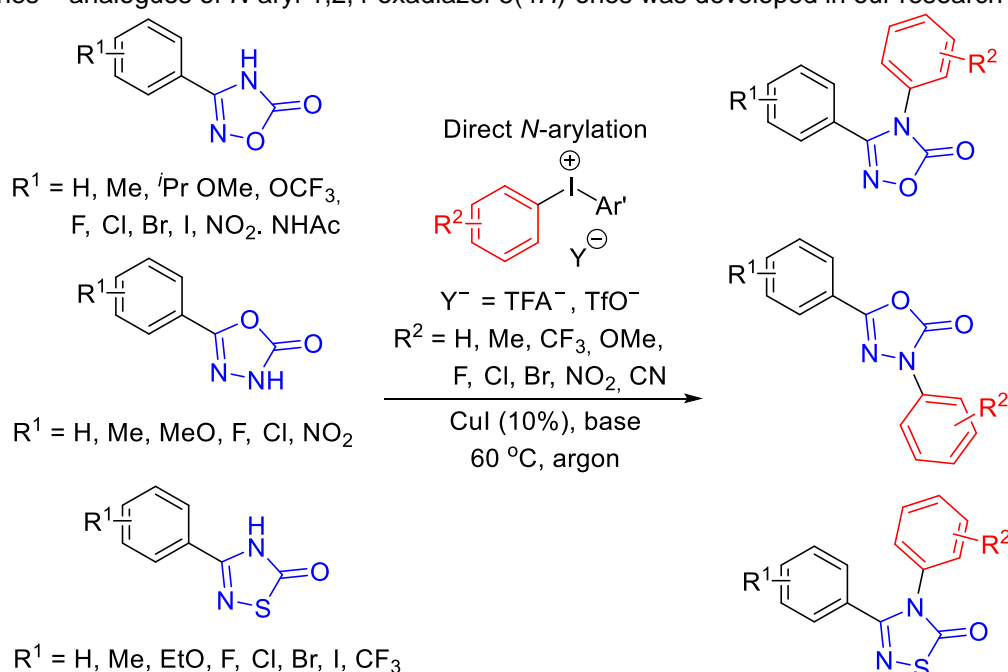

**Scheme 1.** Synthesis pathway for *N*-arylated 1,2,4-, 1,3,4-oxadiazol-5(4*H*)-ones and 1,2,4-thiadiazol-5(4*H*)-ones.

Herein we report the applicability of diaryliodonium salts as effective reactants for electrophilic C–N coupling in synthesis of *N*-aryl-1,2,4-, *N*-aryl-1,3,4-oxadiazol-5(4*H*)-ones and *N*-aryl-1,2,4-thiadiazol-5(4*H*)-ones.

## References

- [1] *J. Int. Mol. Sci.* **2023**, *24*(6), 5406
- [2] *Inorg. Chem.* **2023**, *62*(15), 6129
- [3] *Adv. Synth. Catal.* **2021**, *262*(14), 3566

## Acknowledgements

This work was supported by the Russian Science Foundation (project No 22-73-10031).

The authors are grateful to the Magnetic Resonance Research Center, and Center for Chemical Analysis and Materials Research (all belonging to Saint Petersburg State University) for the physicochemical studies.

## COBALT-CATALYZED PEROXIDATION OF CYCLIC CH-ACIDS

*Pavel. Yu. Serdyuchenko*<sup>1</sup>, *Oleg. V. Bityukov*<sup>1,2</sup>, *Vera. A. Vil*<sup>1</sup>, *Alexander. O. Terent'ev*<sup>1,2</sup>

<sup>1</sup> N. D. Zelinsky Institute of Organic Chemistry Russian Academy of Sciences, Moscow, Russia

<sup>2</sup> D. I. Mendeleev University of Chemical Technology of Russia, Moscow, Russia  
Researcher (Master)  
[mr.pavelser@mail.ru](mailto:mr.pavelser@mail.ru)

Today, organic peroxides are an important part of the chemical industry. Members of this class of compounds are widely used in the polymeric industry as initiators of free radical polymerization [1], as well as in medicine and agrochemistry, as active agents of anti-parasitic, anti-malarial and bactericidal drugs [2]. So, research and development of methods of selective synthesis of new organic peroxides is a topical direction.

The present work is devoted to the development of a method for the introduction of the *tert*-butyl peroxy fragment into the cyclic CH-acids (Scheme 1) and is a continuation of the research of the laboratory №13 team on the topic: peroxidation of  $\beta$ -dicarbonyl compounds and their derivatives. It was found that salts of Co(II) are able to catalyze the peroxidation of a wide range of alkyl/aryl substituted cyclic CH-acids, such as 4-hydroxy-2(5*H*)-furanones and Meldrum acids (Scheme 1).

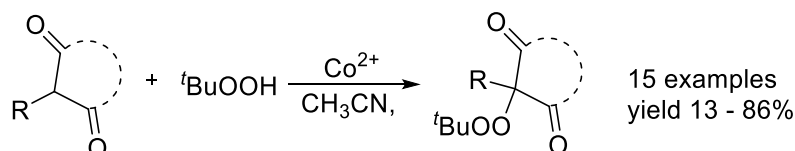

**Scheme 1.** Co-catalyzed peroxidation of cyclic CH-acids.

The relevance of the work is supported by the possibility of obtaining useful substances. Derivatives of 4-hydroxy-2(5*H*)-furanonones could be used as the active substances in medicinal chemistry and agrochemistry, and the introduction of peroxy fragment can expand the field of application [3].

### References

- [1] *John Wiley and Sons*, **1992**, 195-219
- [2] *Med. Res. Rev.* **2004**, *24*, 425–448
- [3] *Synthesis*, **2006**, *19*, 3157-3188

### Acknowledgements

The work was financially supported by the RSF grant 21-73-10016.



## UNEXPECTED PHOTOREACTIONS OF SEMI-STIFF-DIARYLETHENES

*Sergeeva E.S.*<sup>1,2</sup>, *Svistova A.A.*<sup>1,2</sup>, *Vologzhanina A.V.*<sup>3</sup>, *Lyssenko K.A.*<sup>4</sup>, *Ushakov I.A.*<sup>1</sup>, *Lvov A.G.*<sup>1,2</sup>

<sup>1</sup> A. E. Favorsky Irkutsk Institute of Chemistry, Irkutsk, Russia

<sup>2</sup> Irkutsk National Research Technical University, Irkutsk, Russia

<sup>3</sup> A. N. Nesmeyanov Institute of Organoelement Compounds, Moscow, Russia

<sup>4</sup> Department of Chemistry, Lomonosov Moscow State University, Moscow, Russia

Student

[lvov-andre@yandex.ru](mailto:lvov-andre@yandex.ru)

Diarylethenes undergo various types of irreversible light-induced reactions, based on 6 $\pi$ -cyclization with subsequent rearrangements and oxidations [1, 2]. In our work, we study photochemistry of semi-stiff-diarylethenes, hybrids of common diarylethenes and stiff-stilbenes [3, 4]. We found, that the presence of an additional cyclohexanone ring (in the enol form) in the structure opens new reaction pathways for photoactive diarylethenes.

As a model semi-stiff-diarylethene we use compound **1**, previously synthesized by one of us [5]. In various conditions, this substrate could form anthracene derivative **2**, product of formal methane elimination **3** and product of formal [1,3]-hydrogen shift **4**. In the presentation, we will discuss the impact of reaction conditions on the photoreactions of semi-stiff-diarylethene **1** and its analogues as well as molecular structure of the photoproducts.

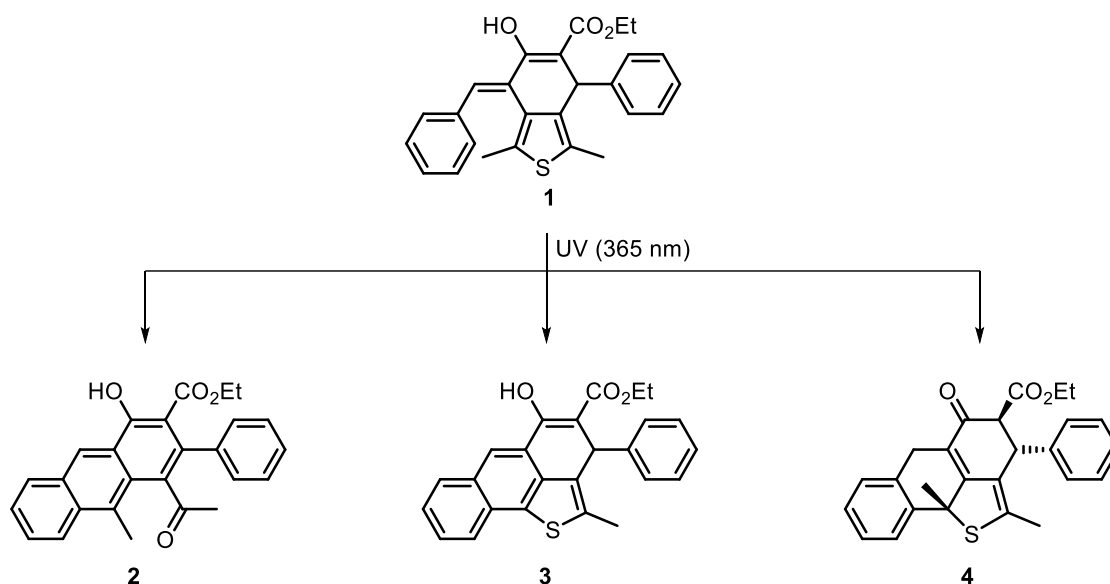

### References

- [1] *Molecules*. **2010**, *15*, 4334
- [2] *J. Org. Chem.* **2020**, *85*, 14, 8749
- [3] *J. Chem. Soc., Perkin Trans. 2*, **1988**, 39
- [4] *Angew. Chem. Int. Ed.* **2020**, *59*, 13192
- [5] *Chem. Heterocycl. Compd.* **2015**, *51*, 234

### Acknowledgements

This work was supported by the Ministry of Science and Higher Education of the Russian Federation (FZZS-2024-0001).

A SYNTHESIS AND PHOTOPHYSICAL PROPERTIES OF 6-ETHYL-6,12-DIHYDRODIBENZO[*b,h*][1,5]NAPHTHYRIDIN-7(5*H*)-ONES

*Shatsauskas A.L.*<sup>1,2</sup>, *Kirnosov S. A.*<sup>1</sup>, *Petrova A. V.*<sup>1</sup>, *Zheleznova T. Yu.*<sup>2</sup>, *Fisyuk A. S.*<sup>1,2</sup>

<sup>1</sup> Dostoevsky Omsk State University, Omsk, Russia

<sup>2</sup> Omsk State Technical University, Omsk, Russia

Young scientist, PhD

[a.i.shatsauskas@chemomsu.ru](mailto:a.i.shatsauskas@chemomsu.ru)

Two approaches were proposed to the synthesis of dibenzo[*b,h*][1,5]naphthyridin-7(12*H*)-ones **3a-e** [1]. The one-step method based on the Pictet–Spengler reaction of 3-amino-2-phenylquinolin-4(1*H*)-one **1** [2] with aromatic aldehydes requires heating in a strong acidic media, which leads to significant limitations on the possible products. The second approach is based on the conversion of 3-amino-2-phenylquinolin-4(1*H*)-one **1** to 4-phenyl[1,3]oxazolo[4,5-*c*]quinolines **2a-e** followed by rearrangement under the action of AlCl<sub>3</sub>. A significant advantage of the two-step synthesis is the possibility of obtaining a wider range of dibenzo[*b,h*][1,5]naphthyridin-7(12*H*)-ones, including those not available using the Pictet–Spengler reaction.

Reduction of dibenzo[*b,h*][1,5]naphthyridin-7(12*H*)-ones **3a-e** with NaBH<sub>4</sub> in acetic acid [3] leads to 6-ethyl-5,6-dihydrobenzo[*b,h*][1,5]naphthyridin-7(12*H*)-ones **5a-e**, which are fluorophores emitting in the yellow-green region of the spectrum with a fluorescence quantum yield of up to 0.25 and anomalously large Stokes shifts of up to 156 nm.

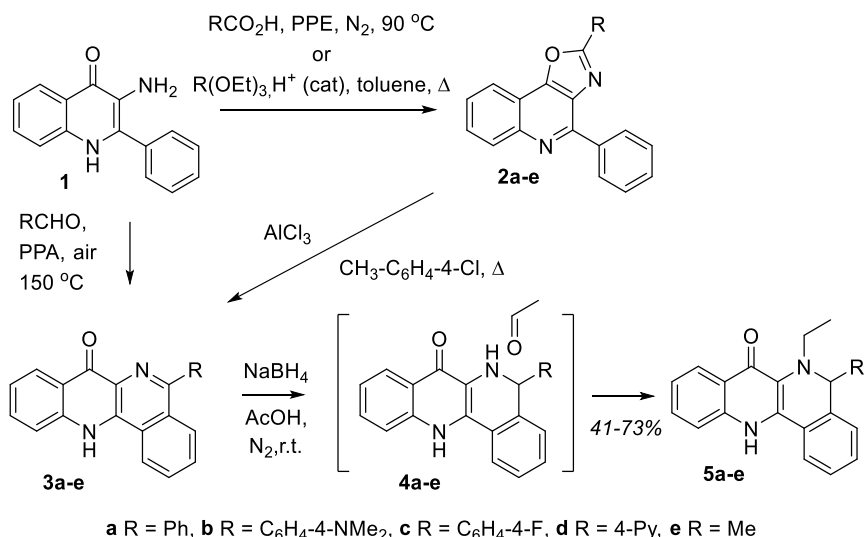

**Scheme 1.** Synthesis of 6-ethyl-6,12-dihydrodibenzo[*b,h*]-1,5-naphthyridin-7(5*H*)-ones **5a-e**.

### References

[1] Synthesis 2024, in press; doi: 10.1055/a-2323-0770

[2] *Org. Chem.* **2006**, *71*, 819

[3] *Dyes Pigment.* **2022**, *204*, 110388

### Acknowledgements

This work was supported by the Russian Science Foundation (project No 23-73-01151).

# PHOTOCHROMIC DIARYLETHENE CONTAINING N-HETEROCYCLIC CARBENES

*Shnigirev R.B.*<sup>1,2</sup>, *Lvov A.G.*<sup>1,2</sup>

<sup>1</sup> A. E. Favorsky Irkutsk Institute of Chemistry, Irkutsk, Russia

<sup>2</sup> Irkutsk National Research Technical University, Irkutsk, Russia

Student

[rustam@irioch.irk.ru](mailto:rustam@irioch.irk.ru)

N-Heterocyclic carbenes (NHC) based on nitrogen-containing heterocycles have long been used as ligands for transition metal complexes as well as in organocatalysis [1,2]. The addition of NHCs into the photochromic system, in particular diarylethenes, will open access to catalysts with light-controlled activity and selectivity [3]. Previously, Bielawski showed that diarylethene containing a NHC fragment can be used as an organocatalyst and ligand for iridium(I) and ruthenium(IV) complexes, which further allowed the realization of light-controlled catalysis of various reactions [4,5].

In the works available so far, the N-heterocyclic fragment is as a linker between two aryl moieties [6]. In our work, we have integrated this fragment in replacement of one of the aryl rings. This arrangement of NHC will directly affect the electronic structure of such systems, and as a result of their photochemistry.

We have developed a new synthetic methodology for the construction of photochromic precursors of N-heterocyclic carbenes **I** from which the corresponding transition metal complexes **II** and **III** were obtained. The synthesis and photochemical properties of photochromic imidazolium salts and their complexes with transition metals will be presented.

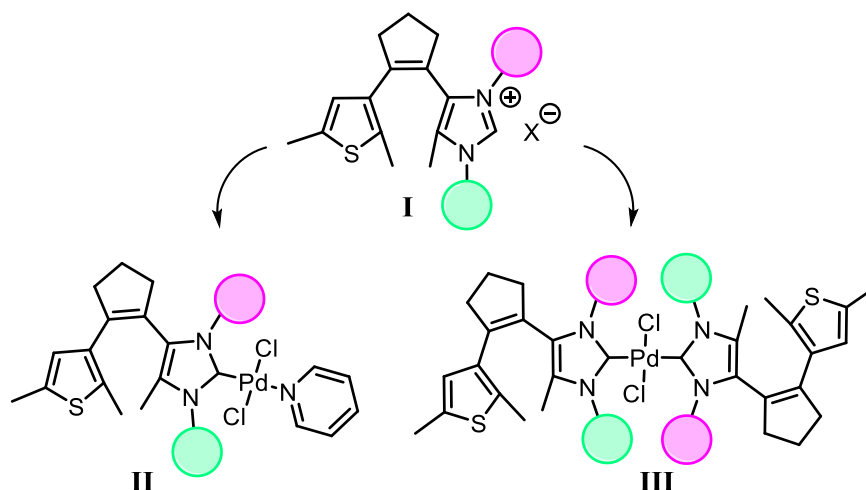

**Scheme 1.** Photochromic imidazolium salts and their palladium complexes.

## References

- [1] *Chem. Sci.* **2020**, *11*, 6957
- [2] *Chem. Rev.* **2015**, *115*(17), 9307-9387
- [3] *ACS Catal.* **2013**, *3*(8), 1874-1885
- [4] *Angew. Chemie - Int. Ed.*, **2011**, *50*, 10322
- [5] *J. Am. Chem. Soc.* **2012**, *134*(30), 12693-12699
- [6] *J. Am. Chem. Soc.* **2009**, *131*(3), 912-913

## Acknowledgements

This work was financially supported by the Ministry of Science and Higher Education of the Russian Federation within the framework of the Baikal World-class Scientific and Educational Centre (FZZS-2024-0001).

# ENHANCING THE PHOTOCATALYTIC EFFICIENCY OF PYRAZINOPORPHYRINS: INNOVATIVE STRATEGIES AND PERSPECTIVES

*Shremzer E.S.<sup>1,2</sup>, Polivanovskaia D.A.<sup>1</sup>, Birin K.P.<sup>1</sup>, Tsivadze A.Yu.<sup>1</sup>*

<sup>1</sup> The Institute of Physical Chemistry and Electrochemistry RAS, Moscow, Russia

<sup>2</sup> Moscow Institute of Physics and Technology, Moscow, Russia

Master

[catherineshremzer@yandex.ru](mailto:catherineshremzer@yandex.ru)

Porphyrins are a class of macroheterocyclic compounds possessing unique electronic and chemical properties. Their capability of energy or electron transfer under photoexcitation determined their intensive investigation as photocatalysts for organic reactions. Modification of the periphery of the tetrapyrrole macrocycle enables the precise tuning of its optical and redox properties, which consequently affects the catalytic performance of the resulting derivatives. In light of the increasing relevance of photocatalysis for various applications, there is a significant demand for strategies to enhance the efficiency of porphyrin-based catalysts.

In response, a series of novel free-base pyrazine-appended porphyrins with an expanded aromatic system **2H-1** – **2H-5** and corresponding indium(III) complexes **InCl-1** – **InCl-5** were successfully synthesized, containing peripheral polycyclic (phenanthroline, phenanthrene, acenaphthene) fragments or ethyl, tolyl substituents. Photocatalytic investigations into the oxidation of thioanisole demonstrated that the indium(III) complexes, even at low catalyst loading of  $5 \cdot 10^{-4}$  mol.%, achieve complete substrate conversion within 16 hours with high selectivity (up to 99%) and a turnover number (TON) of up to 200,000. In contrast, similar performance with free bases required higher loading of  $10^{-2}$  mol.%, providing a TON of up to 10,000. This indicates that the expansion of the  $\pi$ -system of heterocycle-appended porphyrins and further incorporation of metal ion can effectively control the photochemical properties of the photosensitizers.

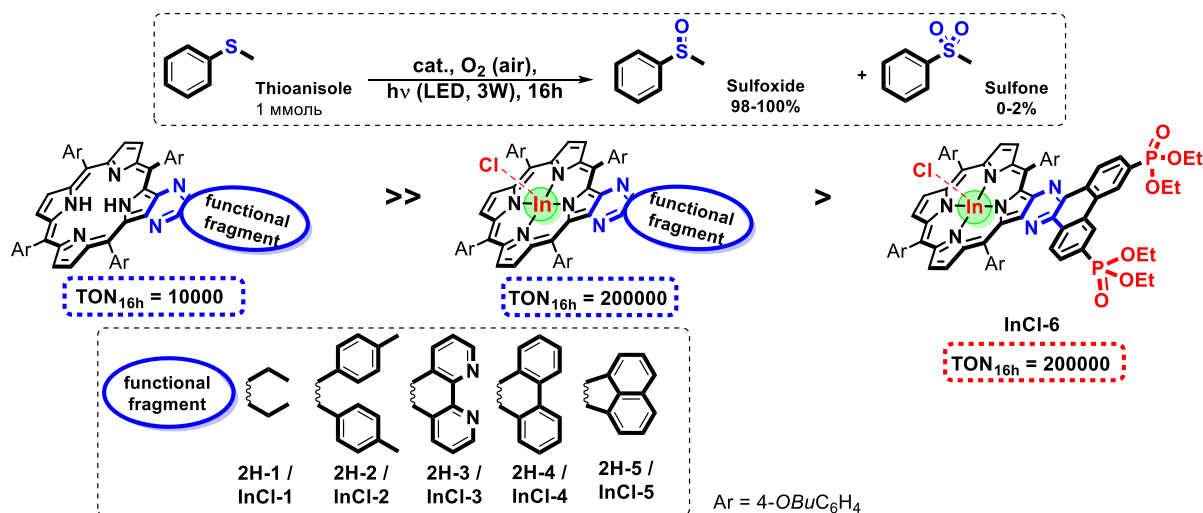

**Scheme 1.**  $\pi$ -Expanded pyrazinoporphyrins in photocatalysis.

Further enhancements were achieved by introducing phosphonate groups and forming indium(III) complex that markedly improved photocatalytic efficiency, achieving TON of 200,000 with just  $5 \cdot 10^{-4}$  mol.% catalyst loading. The introduction of functional phosphonate groups into the periphery of the phenanthrene fragment further augments this efficiency, paving the way for the development of new hybrid catalytic materials based on  $\pi$ -expanded porphyrins.

## Acknowledgements

This work was supported by the Russian Science Foundation (project No 23-23-00542).

## RADICAL ALKYLATION USING ACYCLIC DIACYL PEROXIDES

*Shuingalieva D.V.*<sup>1</sup>, *Vil' V.A.*<sup>1</sup>, *Gorlov E.S.*<sup>1</sup>, *Akulov A.A.*<sup>2</sup>, *Varaksin M.V.*<sup>2</sup>, *Terent'ev A.O.*<sup>1</sup>

<sup>1</sup> N. D. Zelinsky Institute of Organic Chemistry Russian Academy of Sciences, Moscow, Russia

<sup>2</sup> Ural Federal University, Ekaterinburg, Russia

Graduate student

[diana-shuingalieva@mail.ru](mailto:diana-shuingalieva@mail.ru)

The formation of a carbon-carbon bond is the fundamental goal of synthetic organic chemistry. The last three Nobel Prizes in synthetic organic chemistry (2022, 2021, 2010) were awarded especially for the development of methods for selective C-C bond formation. Whilst many of the recent advantages in this area have employed as both traditional electrophile-nucleophile coupling and reactive transition metal complexes, it important to remember that the formal functionalization of C-H bonds by reactive free radicals has a longstanding history in organic chemistry.

Herein we focus on C(sp<sup>3</sup>)-C(sp<sup>2</sup>) bond formation. A major breakthrough in this field was achieved in the 1960s with the discovery of Minisci couplings, which have been widely used by chemists seeking to functionalize aromatic heterocycles in a rapid and direct manner, avoiding the need for de novo heterocycle synthesis.

The selective alkylation of heterocycles with radicals generated from diacyl peroxides using a metal-containing catalyst was developed [1].

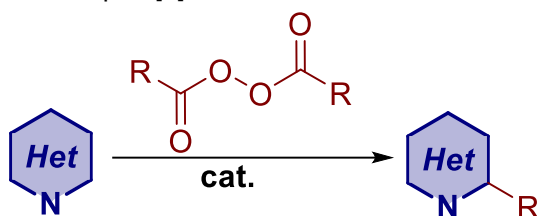

**Scheme 1.** The concept of the work.

### References

[1] *Russ. Chem. Rev.* **2021** 90(3), 374

### Acknowledgements

This work was supported by the Russian Science Foundation (project No 24-43-00111).

## SYNTHESIS OF DAIDZEIN DERIVATIVES FOR TARGETED DELIVERY

*Sidorova A.I.*<sup>1</sup>, *Koval V.S.*<sup>1</sup>, *Morozova E.A.*<sup>1</sup>, *Revtovich S.V.*<sup>1</sup>, *Kulikova V.V.*<sup>1</sup>, *Anufrieva N.V.*<sup>1</sup>,  
*Solyev P.N.*<sup>1</sup>

<sup>1</sup> Engelhardt Institute of Molecular Biology of the Russian Academy of Sciences, Moscow, Russia  
Master's student

[aliona.sidorova.2002@mail.ru](mailto:aliona.sidorova.2002@mail.ru)

Isoflavones are non-steroidal diphenolic compounds isostructural to the endogenous gonadal steroid, 17 $\beta$ -estradiol. The similarity of chemical structure allows them to bind competitively with estrogen receptors  $\alpha$  (ER $\alpha$ ) and  $\beta$  (ER $\beta$ ), that can be used in the treatment of estrogen-dependent tumors as well as an anchor for drug-delivery to the tumor cell surface. [1]

One member of the isoflavone class – daidzein – has been selected for construction of “linker-anchor” combination in our work due to its high affinity to ER.

We propose an improved chromatography-free method for the synthesis of daidzein derivatives coupled with the commonly used linker groups containing carboxyl and amino residues. The yield of compound **6** (Scheme 1) was 51%, with overall yield on 8 steps of 39%. Chemical optimizations in the daidzein linker synthesis were summarized in our submitted article [2].

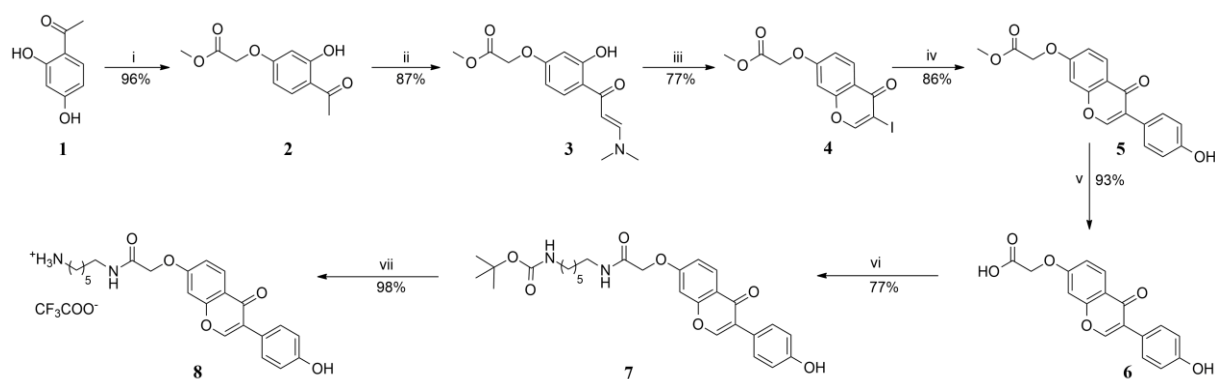

**Scheme 1.** Synthesis of daidzein derivatives. Reagents and conditions: i: K<sub>2</sub>CO<sub>3</sub>, BrCH<sub>2</sub>COOMe, DMF; ii: DMF-DMA, DMF; iii: I<sub>2</sub>, MeOH; iv: PEG 3350, Pd(OAc)<sub>2</sub>, Na<sub>2</sub>CO<sub>3</sub>, 4-OH-PhB(OH)<sub>2</sub>; v: 50% AcOH; vi: BocNH(CH<sub>2</sub>)<sub>6</sub>NH<sub>2</sub>, HBTU, DIPEA, DMF; vii: TFA.

The final daidzein derivative **8** was coupled with the recombinant C115H methionine- $\gamma$ -lyase (MGL) from *Clostridium novyi*. The resulting C115H-Dz conjugate were studied *in vitro* and *in vivo* in collaboration with Blokhin National Medical Research Center of Oncology and Gamaleya National Research Center of Epidemiology and Microbiology [3]. It was demonstrated that C115H-Dz specific binding to the ER<sup>+</sup>, HER2<sup>+</sup>, PR<sup>+</sup>, and basal breast adenocarcinoma cells allowed to produce *in situ* cytotoxic thiosulfinates from the infused S-(allyl/alkyl)-L-cysteine sulfoxides right at the surface of the breast cancer cells. Moreover, these conjugates of encapsulated C115H MGL with daidzein improved overall pharmacokinetic parameters compared to the native enzyme.

### References

- [1] *Chem. Pharm. Bull.* **2009**, 57(4), 346-360
- [2] *Koval V.S., Sidorova A.I., et al. Optimized synthesis of daidzein derivatives for targeted delivery // submitted to Tetrahedron letters*
- [3] *Biochimica* **2022** 201, 177-183

### Acknowledgements

This work was supported by the Russian Science Foundation (project № 20-74-10121-P).

# A NEW APPROACH FOR THE SYNTHESIS OF MEROCYANINE DYES VIA ENAMINATION OF 4H-PYRANES AND THEIR DERIVATIVES

*Simbirtseva A.E., Obydenov D.L., Kornev M.Y., Sosnovskikh V.Y.*

Ural Federal University, Yekaterinburg, Russia

PhD Student

[a.e.simbirtseva@urfu.ru](mailto:a.e.simbirtseva@urfu.ru)

Merocyanines are neutrally charged donor-acceptor polymethine dyes that pay attention because of their photophysical properties and wide practical application in bioimaging and material science.

We developed a new general method for the synthesis merocyanine dyes *via* enamination of 2-methyl-4-pyrone [1], 4-methylene-4H-pyrans [2] and 4-methylene-1,4-dihydropyridines. The main advantages of this method are high chemoselectivity, availability of reagents and wide scope of involved substrates.

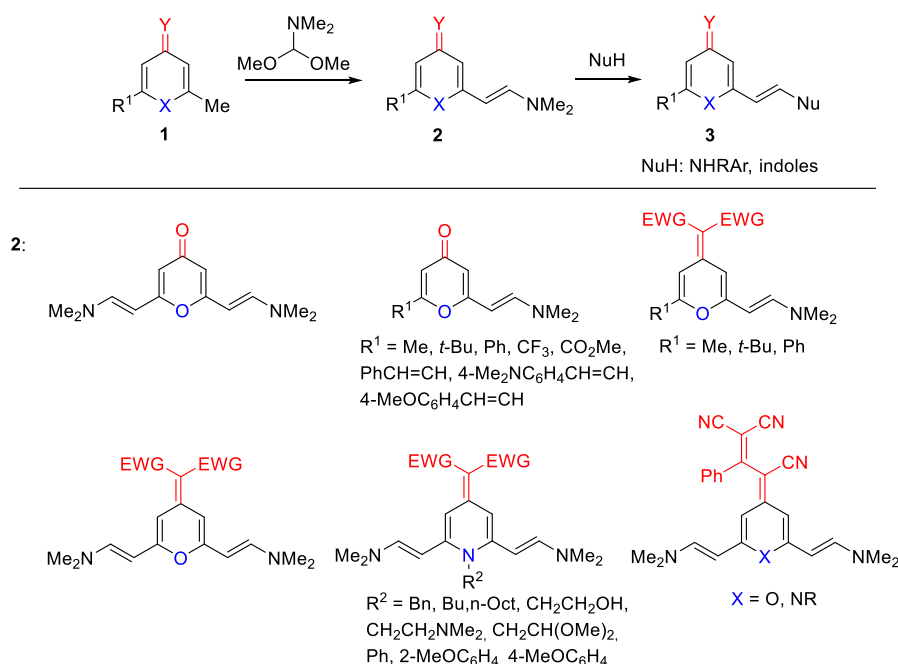

**Scheme 1.** Synthesis mono- and bis-substituted merocyanines **2** and **3**.

*N,N*-Dimethylformamide dimethyl acetal was used as an enamination reagent. Variation of reaction conditions made it possible to obtain mono- and bis-enaminosubstituted products. Following conjugate addition of enamines **2** with C- and N-nucleophiles proceeded *via* the substitution of the dimethylamino group to form dyes **3**. A feature of prepared merocyanines **2** and **3** is good photostability, large Stokes shift, wide absorption wave range, and tunable emission. The main the substituent effects on photophysical properties were determined for the targeted design of dyes.

Thus, we found a novel method of the modification for conjugated pyrane derivatives and synthesized a wide range of new dyes with valuable photophysical properties.

## References

- [1] *Molecules* **2022**, *27*, 8996  
 [2] *Org. Biomol. Chem.* **2023**, *21*, 600-620

## Acknowledgements

The research funding from the Ministry of Science and Higher Education of the Russian Federation (Ural Federal University Program of Development within the Priority-2030 Program) is gratefully acknowledged.

# THE CATALYTIC REDUCTION OF TRIMETHYLAMINE N-OXIDE IN REACTION WITH THE TUNGSTEN-CONTAINING ENZYME MODEL COMPLEX

*Simonova V.M.<sup>1</sup>, Khripun V.D.<sup>2</sup>, Pestova O.N.<sup>1</sup>*

<sup>1</sup> St. Petersburg State University, St. Petersburg, Russia

<sup>2</sup> University of São Paulo, São Paulo, Brazil

Student

[visucha\\_sk@mail.ru](mailto:visucha_sk@mail.ru)

Tungsten enzymes are found in anaerobic organisms and play a role in the transformation of the main biogenic elements, such as oxygen, nitrogen, and sulfur [1]. These enzymes transfer an oxygen atom between the substrate and themselves, this process is called the oxotransfer. The oxotransfer mechanism of these enzymes is currently being studied using model complexes that mimic the active enzyme centers. One of such model compounds is the maleonitrileditolate complex  $[\text{Et}_4\text{N}]_2[\text{WO}(\text{mnt})_2]$ , where  $\text{mnt}^{2-} = \{\text{S}_2\text{C}_2(\text{CN})_2\}^{2-}$  [2].

In the present work the reaction between complex  $[\text{Et}_4\text{N}]_2[\text{WO}(\text{mnt})_2]$  and  $\text{Me}_3\text{NO}$  in non-aqueous solution was studied. The model reaction was carried out in various molar ratios of the reagents. The composition of the reaction mixture and its evolution over time were monitored using UV-Vis and  $^1\text{H}$ ,  $^{13}\text{C}$  NMR spectroscopy (figure 1).

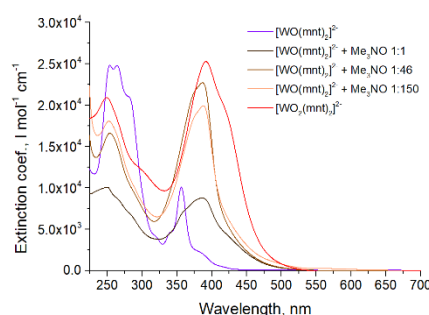

**Figure 1.** UV-VIS spectra of individual complexes and reaction mixtures with different component ratios.

In this work we have shown that  $\text{Me}_3\text{NO}$  undergoes reduction in the presence of  $[\text{Et}_4\text{N}]_2[\text{WO}(\text{mnt})_2]$ . Furthermore, the reaction proceeds completely, even in the presence of a ten-fold excess of  $\text{Me}_3\text{NO}$ , albeit it takes a relatively long time. Thus, we believe that the process in the  $[\text{Et}_4\text{N}]_2[\text{WO}(\text{mnt})_2]/\text{Me}_3\text{NO}$  system constitutes a catalytic reduction of the substrate, with the tungsten complex acting as a catalyst (scheme 1).

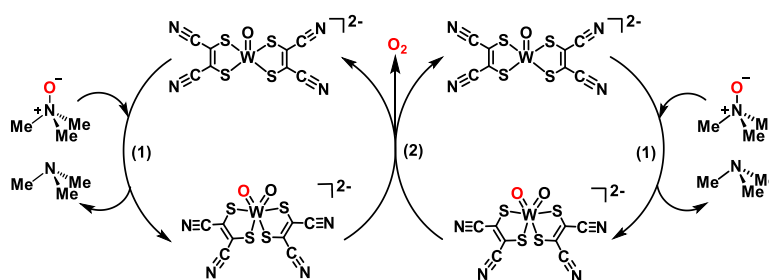

**Scheme 1.** The proposed catalytic cycle involving  $[\text{Et}_4\text{N}]_2[\text{WO}(\text{mnt})_2]$ .

## References

[1] *Trends Biochem. Sci.* **2002**, *27*, 360–367

[2] *JACS.* **1996**, *118*, 1387–1397

## Acknowledgements

The NMR and UV-Vis measurements have been carried out in the Center for Magnetic Resonance and Chemical Analysis and Materials Research Centre of Research Park of St. Petersburg State University.



# DESIGN, SYNTHESIS AND BIOLOGICAL EVALUATION OF HYDROPHILIC PRODRUGS OF HETEROCYCLIC ALLOCOLCHICINOIDS

*Sitdikova A.R.*<sup>1</sup>, *Shchegravina E.S.*<sup>1</sup>, *Svirshchevskaya E.V.*<sup>2</sup>, *Fedorov A.Yu.*<sup>1</sup>

<sup>1</sup>Lobachevsky State University, Nizhny Novgorod, Russia

<sup>2</sup>Shemyakin-Ovchinnikov Institute of Bioorganic Chemistry RAS, Moscow, Russia

Student

[abdulkader@yandex.ru](mailto:abdulkader@yandex.ru)

Colchicine is a naturally occurring antimetabolic drug possessing strong antiproliferative activity. Although the high systemic toxicity of colchicine significantly restricts its clinical application, due to widely spread natural sources of colchicine, and the convenience of its structure for chemical modification, this molecule still presents an attractive synthetic platform. One of the ways to overcome the toxicity of colchicine is to create analogue molecules with improved characteristics. The resulting dihydrofuranoalcolchicinoid **1** demonstrated high antiproliferative activity in the picomolar concentration range against a number of cell lines and reduced acute toxicity (LD<sub>50</sub>) compared with natural colchicine [1]. However, the resulting molecule isomerizes in an acidic environment and has insufficient bioavailability due to low solubility.

An analogue of this colchicinoid **2** containing fluorine atoms in the  $\alpha$ -position with respect to the double bond, which prevent isomerization, demonstrated even more promising results in inhibiting the growth of tumor cells [1].

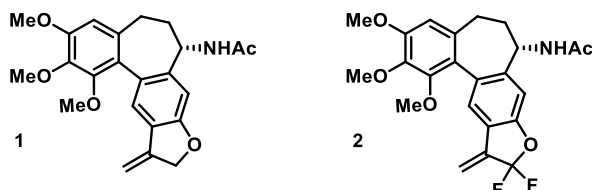

**Scheme 1.** Active dihydrofuranoalcolchicinoids.

Based on the obtained colchicinoids **1** and **2**, prodrugs **3** and **4** were synthesized, in which the active agents are colchicine derivatives bound by a triazole linker to maltose, which ensures the water solubility of this conjugates, thereby increasing their bioavailability.

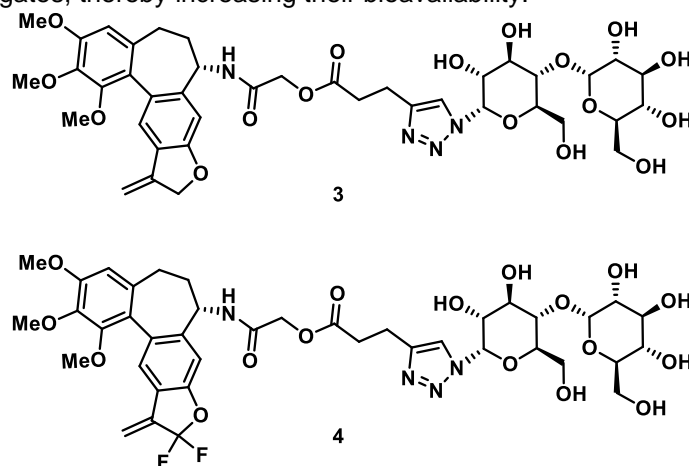

**Scheme 2.** Structures of the target prodrugs.

Biological studies of the obtained target conjugates **3** and **4** were conducted *in vitro* and *in vivo*.

## References

[1] *Eur. J. Med. Chem.* **2020**, *207*, 112724

## Acknowledgements

This work was supported via State assignment in Research scientific laboratory of «Chemistry of natural products and their synthetic analogues» of Scientific Educational Centre «Technoplatfrom 2035» (FSWR-2024-0002).

# A NEW CLASS OF CATIONIC PHOSPHINE LIGANDS CONTAINING A PHOSPHONIUM MOIETY: SYNTHESIS AND PHOTOPHYSICAL PROPERTIES

*Snetkov D.A.<sup>1</sup>, Grachova E.V.<sup>1</sup>*

<sup>1</sup> St Petersburg University, St. Petersburg, Russia

Bachelor student

[st084974@student.spbu.ru](mailto:st084974@student.spbu.ru)

Cationic phosphine ligands are currently an interesting object in terms of organoelement, coordination chemistry and catalysis. The introduction of positively charged groups on the periphery of the phosphine molecule contributes to a significant change in electronic properties as well as physicochemical characteristics, such as water solubility, air stability [1], and catalytic activity [2]. On the other hand, the replacement of standard neutral phosphine ligands with cationic ligands should potentially be accompanied by significant changes in photophysical properties of a transition metal complex.

The cationic phosphonium group —PPh<sub>2</sub>Me<sup>+</sup> has been shown in many studies to be a good acceptor fragment capable of influencing the emission characteristics and photoinduced charge transfer processes for various classes of organic and organometallic phosphors with Donor— $\pi$ -linker—Acceptor dyads [3-4]. The additional possibility of application of phosphonium-containing agents in bioimaging and biomedicine increases the interest in such objects [5].

In the present work, a series of phosphonium-containing ligands **PPL** (L = 0—3) differing by the nature of the conjugated linker were synthesized via an unsymmetric quaternization reaction from corresponding bis-diphenylphosphines (Scheme 1).

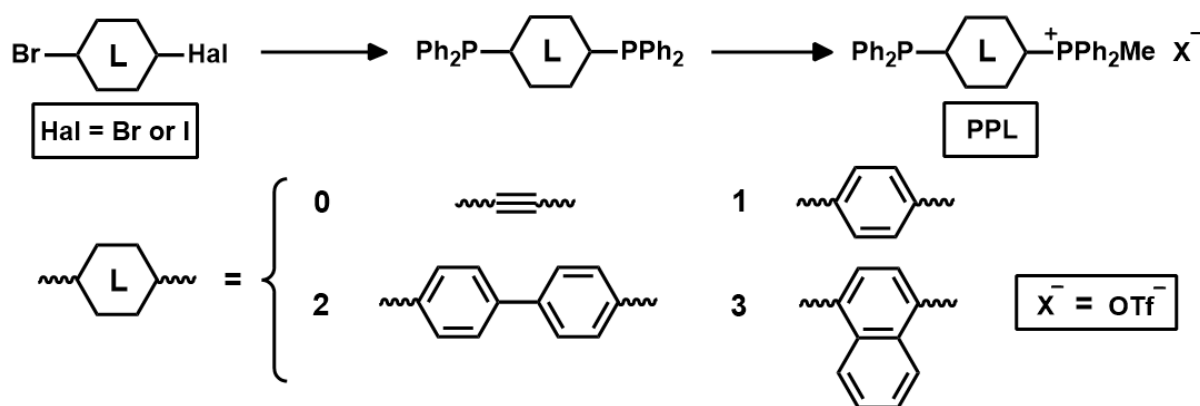

**Scheme 1.** Synthetic pathway of phosphonium-containing ligands **PPL** (L = 0—3).

The compounds obtained were characterized by <sup>1</sup>H, <sup>31</sup>P, <sup>19</sup>F, <sup>1</sup>H-<sup>1</sup>H COSY NMR spectroscopy and high-resolution ESI<sup>+</sup> mass spectrometry. To characterize the systems as Donor— $\pi$ -linker—Acceptor dyads, the UV/vis electronic absorption and luminescence spectra in solution were measured.

## References

- [1] *Chem. Eur. J.* **2014**, *20*, 7868 – 7877
- [2] *Chem. Lett.* **2019**, *48*, 1–13
- [3] *Angew. Chem. Int. Ed.* **2019**, *58*, 13456 – 13465
- [4] *Inorg. Chem.* **2023**, *62*, 5123–5133
- [5] *J. Mol. Liq.* **2024**, *399*, 124381

## Acknowledgements

This work was supported by the Russian Science Foundation (project No 24-13-00024).

Characterization of samples was performed using the facilities of the Resource centers of the SPBU Research Park: “Magnetic Resonance Research Centre”, “Chemical Analysis and Materials Research Centre”.

# INTERACTION OF PURINE NUCLEIC BASE PERCHLORATES WITH ACETYLACETONE

*Sokolova A.N.<sup>1</sup>, Bezhenar G.V.<sup>2</sup>, Zdereva P. S.<sup>3</sup>, Paponov B.V.<sup>4</sup>*

<sup>1</sup> Department of physical chemistry, Saint Petersburg State Technological Institute (TU),  
St. Petersburg, Russia

<sup>2</sup> Gymnasium № 631, St. Petersburg, Russia

<sup>3</sup> School № 212, St. Petersburg, Russia

<sup>4</sup> Department of general & bioorganic chemistry, Pavlov First State Medical University, St. Petersburg,  
Russia  
Student

[sok5552@mail.ru](mailto:sok5552@mail.ru)

Both purine nucleic bases contain an exocyclic amino group in the pyrimidine fragment of the bicyclic ring and a neighboring endocyclic nitrogen atom, forming a 1,3-dinucleophilic pair. Thus, cyclocondensation with a 1,3-dicarbonyl reagent should lead to the formation of new Azonia systems combining the structural moieties of nucleic bases and cationic alkaloids. At the same time, the reactions of purines with such dielectrophilic reagents as 1,3-dicarbonyl compounds are practically not studied.

Here we report the results of a study of the reactions of adenine and guanine perchlorates with such a 1,3-dielectrophilic reagent as pentane-2,4-dione (acetylacetonone). Surprisingly, the first mention of adenine perchlorate dates back to 2011, while guanine perchlorate is not known at all, despite the fact that both salts can be easily obtained by recrystallisation of the corresponding nucleic acid base from perchloric acid.

The interaction of adenine and guanine perchlorates with acetylacetonone was carried out in a small amount of DMF, at a temperature of 150 °C (temperature of the heating surface of the magnetic stirrer). The structure of the obtained compounds was established by NMR and mass spectroscopy.

For adenine, the reaction proceeds in the stoichiometric ratio of adenine perchlorate: acetylacetonone 1: 2 and is accompanied by opening of the pyrimidine cycle of the adenine molecule and loss of the one-carbon fragment. It was shown that adenine perchlorate reacts with acetylacetonone to form a new heterocyclic compound, 8-(4,6-dimethylpyrimidin-2-yl)-2,4-dimethylimidazo[1,5-a]pyrimidine.

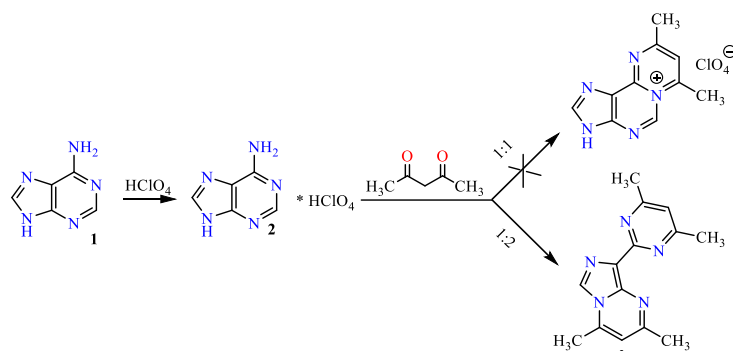

**Scheme 1.** The interaction of adenine perchlorate with acetylacetonone.

In the case of guanine perchlorate, the reaction proceeds in a 1:1 molar ratio and no opening of the pyrimidine moiety of the bicycle is observed.

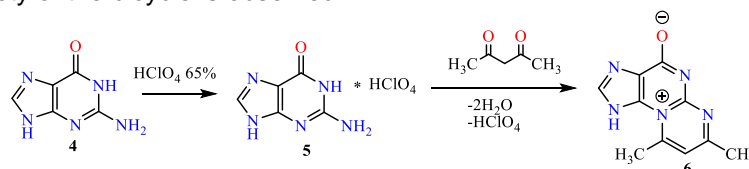

**Scheme 2.** The interaction of guanine perchlorate with acetylacetonone.

Obviously, the reaction proceeds with the participation of the nitrogen atom at position 3 of guanine and exocyclic amino group of the molecule and the reaction product is 7,9-dimethylpyrimido[2,1-b]purine-4(1H)-one.

## REACTION OF AMIDOXIMES WITH PYRIDINE-N-OXIDES

*Solodyankina O.V.*<sup>1</sup>, *Baykova S.O.*<sup>1</sup>, *Baykov S.V.*<sup>1</sup>

<sup>1</sup> St. Petersburg State University, St. Petersburg, Russia

Student

[st095078@student.spbu.ru](mailto:st095078@student.spbu.ru)

Amidoximes are widely used in medicine as sources of nitric oxide (II) [1]. They are also in demand in the development of adsorbents for the removal of heavy metals, in particular uranium [2,3]. In addition, amidoximes have great synthetic potential, being convenient starting compounds in heterocyclic chemistry [4].

It has previously been shown that the hydroxygroup of oximes easily attacks the 2-position of pyridine-N-oxides activated by bromotripyrrolidinophosphonium hexafluorophosphate (PyBrOP). In this case, the corresponding ethers are formed (O-pyridyloximes) [1]. We decided to test the possibility of a similar reaction for amidoximes. As a result of the work done, it was shown that due to the activation of PyBrOP, pyridine-N-oxides are able to react with amidoximes, while forming exclusively oxygen atom substitution products. Optimal process conditions were also selected and 14 previously undescribed O-pyridylamidoximes were synthesized.

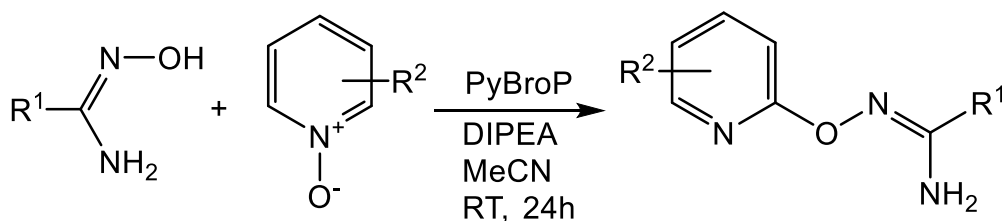

14 examples 79-92%

**Scheme 1.** General synthesis scheme of O-Pyridylamidoximes.

The purity and structure of the obtained compounds were confirmed by NMR spectroscopy (<sup>1</sup>H, <sup>13</sup>C, <sup>19</sup>F) and high-resolution mass spectrometry. In addition, X-ray diffraction studies were performed for three compounds.

### References

- [1] *Molecules* **2019**, *24*, 2470
- [2] *Nucl. Instrum. Methods Phys. Res.* **2005**, *B 236*, 21–29
- [3] *J. Mater. Chem. A* **2020**, *8*
- [4] *Tetrahedron Lett.* **2020**, *61*, 152403
- [5] *Tetrahedron Lett.* **2021**, *78*, 153254

### Acknowledgements

This work was supported by the Russian Science Foundation (project 22-73-10031). Physicochemical studies were performed at the Center for Magnetic Resonance, Center for X-ray Diffraction Studies, Center for Chemical Analysis and Materials Research (all belonging to Saint Petersburg State University).

# MICROREACTORS ARRAY BASED ON WETTABILITY PATTERNS FOR HIGH-THROUGHPUT ORGANIC SYNTHESIS

*Starodubtseva K.V.<sup>1</sup>, Smirnov A.A., Kartsev D.D.*

<sup>1</sup> ITMO University, St. Petersburg, Russia

Student, bachelor

[starodubtseva@scamt-itmo.ru](mailto:starodubtseva@scamt-itmo.ru)

Carrying out chemical reactions in solutions has its advantages and disadvantages. The presence of reagents in one phase helps to increase the rate of the process, meanwhile, interaction with the solvent appears to be an additional barrier. It has been shown that solvent content can be lowered to 1 mass% without phase separation, which results in a  $10^2$ – $10^4$ -fold increase in the reaction rate.[1] Even greater acceleration effect was noticed in charged microdroplets of reaction masses, obtained with electrospray.[2] It is assumed that the acceleration effect, in both cases, is associated with the desolvation of the reacting substances, which happens at the interface of microdroplets or in the media due to solvent evaporation. [2]

The application of this phenomenon in organic synthesis will provide both miniaturization and acceleration. Nevertheless, previously described methods have limitations concerning the collection of the product, cost-effectiveness of methodology and the optimization of reaction conditions.

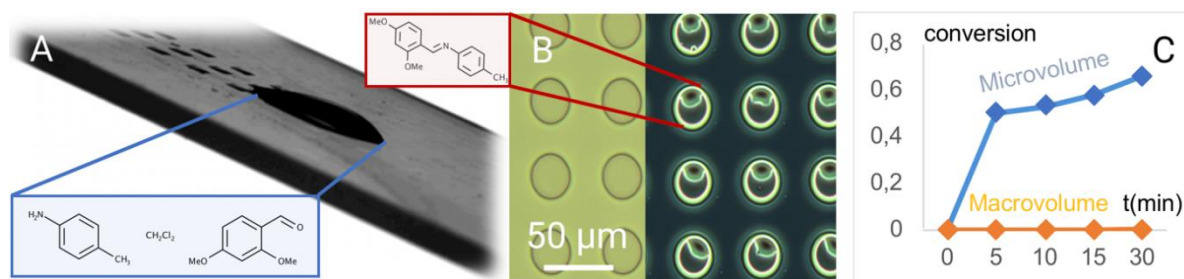

**Figure 1.** **A** Application of droplets array using the running droplet method. **B** Selective application of the reaction mass. **C** Time-conversion rates for Schiff reactions: blue graph – reactants in CHCl<sub>3</sub> applied on the wettability pattern, orange graph – reaction in CDCl<sub>3</sub> at room temperature.

Herein, we introduce an approach for the formation of a reaction mass droplet array. This approach is based on using photolithography of material with omniphobic surface properties to create wettability patterns. The new method resolves the main practical limitations of the known reaction acceleration methods. It allows to generate microdroplets of a reaction mass without using any additional equipment by simply wetting the pattern (fig. 1A, B). In addition, the proposed method represents a convenient model for the study and conditions optimization of reactions in oversaturated solutions due to variability of experiment parameters such as droplet size and solvent.

The formation of Schiff bases was chosen as one of the model reactions for further method characterization, as it was previously studied in other reaction acceleration methods. To inspect the acceleration rate of the new method, we compared the kinetics of Schiff reactions performed on the wettability pattern and in CDCl<sub>3</sub> solution at room temperature (fig. 1C). The reaction mass (2,4-dimethoxybenzaldehyde 0.65 mmol/ml and p-toluidine 1.00 mmol/ml in chloroform) was applied onto the wettability pattern with circle wettable areas  $D = 15$  microns, using the running drop method (fig. 1A). The resulting array of microreactors (fig. 1B) was kept at room temperature. Next, microdroplets containing the product were collected from the pattern with CDCl<sub>3</sub>. Conversion of 50% was achieved on the pattern within 5 minutes of the reaction (NMR analysis). Interestingly, the reaction rate dropped sharply after 5 minutes, which we associate with the crystallization of the reactants. These observations confirm the possibility of the reaction acceleration on wettability patterns.

To further characterize the new method, we plan to study the relation of Schiff reaction speed to the size of the wettable areas. We also plan to study the reaction kinetics in different solvents on patterns.

## References

- [1] *Chem. Commun.* **2006**, 45, 4729-4731  
[2] *ChemPlusChem.* **2021**, 86, 1362-1365

## Acknowledgements

The study was carried out as part of the NIRMA (project No 623100).

# CHEMICAL MODIFICATIONS OF DIHYDROQUERCETIN TOWARDS PHOTOACTIVE DERIVATIVES

*Stepanov A.V.*<sup>1,2</sup>, *Ushakov I.A.*<sup>2</sup>, *Lysenko K.A.*<sup>3</sup>, *Lvov A.G.*<sup>1,2</sup>

<sup>1</sup> Irkutsk National Research Technical University, Irkutsk, Russia

<sup>2</sup> A.E. Favorsky Irkutsk Institute of Chemistry, Irkutsk, Russia

<sup>3</sup> Lomonov Moscow State University, Moscow, Russia

Postgraduate student

[stepanov.andrey96@mail.ru](mailto:stepanov.andrey96@mail.ru)

Chemical compounds from renewable natural sources (e.g., plant biomass) are promising material for production of practically useful products. Dihydroquercetin (taxifolin) **I** is a flavonoid extracted from the bark of various tree species. This compound comprises a benzopyran-4-one core with three hydroxyl groups and an additional aromatic substituent with two hydroxyls. Such a highly functionalized structure could undergo a variety of modification reactions. Currently, dihydroquercetin is a commercially available chemical that can be used as a promising starting material in organic synthesis.

In our work, we study the chemical modification of dihydroquercetin to obtain various light-sensitive derivatives. Isomerization of dihydroquercetin under certain conditions according to modified literature methods [1,2] allowed us to synthesize functionalized stilbenes and aurones, that were studied as photoswitchable compounds for the first time. By oxidation reactions, quercetin derivatives were obtained as promising polymerization initiators [3]. In the report we will discuss the synthesis of various dihydroquercetin derivatives and the results of the study of their photochemical activity.

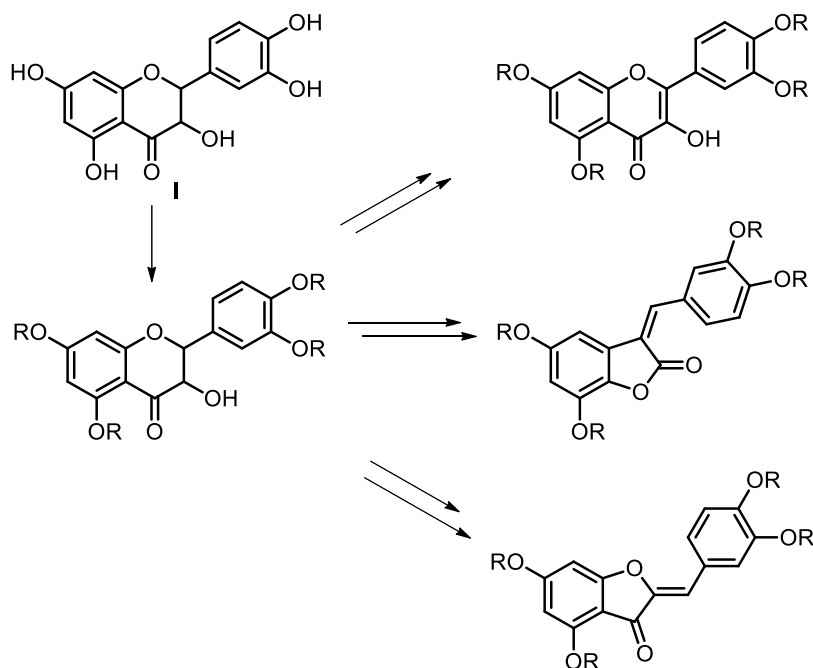

**Scheme 1.** Chemical modifications of dihydroquercetin.

## References

- [1] *J. Org. Chem.* **1956**, 21, 3, 304 – 310
- [2] *J. Nat. Prod.* **2011**, 74, 10, 2243 – 2249
- [3] *Macromol. Mater. Eng.* **2021**, 306, 2100059

## Acknowledgements

The study was supported by the Ministry of Science and Higher Education in the framework of “Baikal” Scientific and Educational Center (FZZS-2024-0001).

## ELECTROOXIDATIVE AMIDATION OF ARENES WITH NITRILES

*Strekalova S.O.*<sup>1</sup>, *Kononov A.I.*<sup>1</sup>, *Khvorova M.A.*<sup>2</sup>, *Zlygostev A.*<sup>2</sup>, *Saveliev G.N.*<sup>2</sup>, *Budnikova Y.H.*<sup>1</sup>

<sup>1</sup> Arbuzov Institute of Organic and Physical Chemistry, FRC Kazan Scientific Center of RAS, Kazan, Russia

<sup>2</sup> A.M. Butlerov Institute of Chemistry, Kazan Federal University, Kazan, Russia  
Researcher, PhD  
[strekalova@iopc.ru](mailto:strekalova@iopc.ru)

Aromatics containing amide substituents are widely used in organic synthesis, medicinal chemistry, materials chemistry, agrochemistry, and catalysis [1]. The amide group is one of the most important fragments that form proteins, peptides and many other biologically significant compounds. Currently, approximately 25% of all commercial drugs and two-thirds of all drug candidates contain at least one amide moiety [2]. So, the search for the new ways to obtain arylamides is undoubtedly relevant.

Organic electrosynthesis in which electrons are utilized as a traceless agent is of increasing interest in dehydrogenative C-H/N-H cross-coupling reactions.

In this work we have developed an electro-oxidative metal-, oxidant- and acid-free straightforward approach to the synthesis of arylamides directly from arenes using nitriles as a source of an amide moiety. The established protocol features excellent yields of up to 87% under mild reaction conditions [3-4].

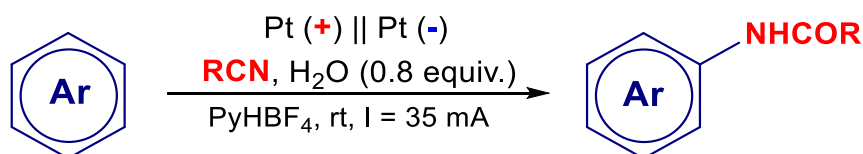

**Scheme 1.** Electro-oxidative amidation of arenes.

Mechanistic studies (voltammetry, EPR, and quantum chemical calculations) revealed that the process is initiated by formation of hydroxyl radicals from residual water molecules on the anode, which attack nitrile solvent, and the resulting amide radicals add to the arene.

### References

- [1] *J. Med. Chem.* **2020**, 63, 12290
- [2] *Nat. Catal.* **2019**, 2, 98
- [3] *Curr. Res. Green Sust. Chem.* **2024**, 8, 100406
- [4] *Adv. Synth. Catal.* **2023**, 365, 3375

### Acknowledgements

This work was supported by the Russian Science Foundation (project № 22-13-00017).

# COPPER-CHROMIUM CATALYSTS FOR THE HYDROGENATION OF FURFURAL TO FURFURYL ALCOHOL IN VARIOUS MODES

*Sumina A.A.<sup>1</sup>, Selishcheva S.A.<sup>1</sup>, Sosnina V.M.<sup>2</sup>, Bulavchenko O.A.<sup>1</sup>, Yakovlev V.A.<sup>1</sup>*

<sup>1</sup> Borekov Institute of Catalysis of the Siberian Branch of the RAS, Novosibirsk, Russia

<sup>2</sup> LLC «BIOKOM», Kirov, Russia

Student

[sumina@catalysis.ru](mailto:sumina@catalysis.ru)

Due to the rapid depletion of fossil resources, there is an urgent problem of finding alternative and renewable sources for the production of raw materials. Many organizations around the world are working to solve this problem, with the chemical industry playing a leading role in this process. One of the major challenges for industry is to develop sustainable methods for converting biomass into valuable chemical compounds. One such compound is furfural, which can be successfully processed into a range of high added value substances (Fig.1). About 60-70% of the resulting furfural is processed into furfuryl alcohol, which is an important monomer in the synthesis of furan resins, and is also used as a solvent in a number of syntheses [1,2].

At the moment, the industrial process of hydrogenation of furfural into furfuryl alcohol is carried out in two modes: vapor and liquid phase. The first involves the use of lower pressure and temperature values, which simplifies the design of reactors [3]. In Russia, this process is at the stage of development and requires the selection of conditions. Currently, there are many industrial catalysts for the hydrogenation of furfural to furfuryl alcohol. In Russia, the most common are copper-chromium systems used for liquid-phase hydrogenation. Nevertheless, in the future, these catalysts can be used in the gas-phase furfural processing, which can simplify the reactor and reduce the cost of production (Fig. 1).

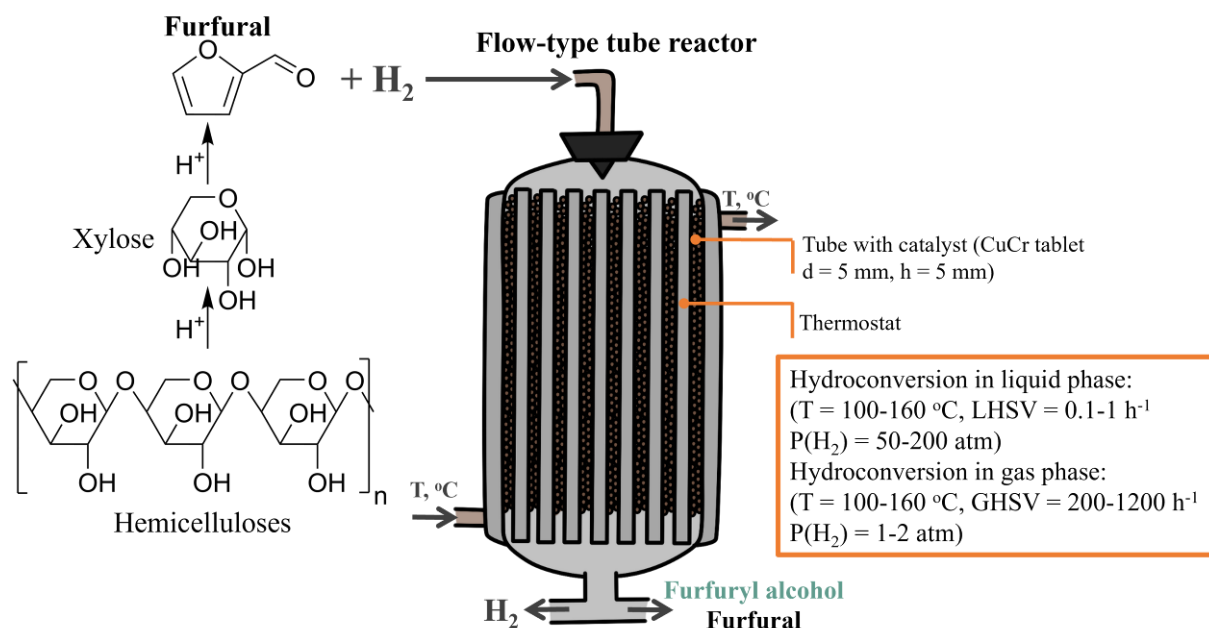

**Figure 1.** Scheme of furfural production and processing in an industrial reactor.

In this work, the process of vapor-phase and liquid-phase hydrogenation of furfural to furfuryl alcohol in the presence of an industrial copper-chromium catalyst will be considered, optimal conditions for the process will be selected and life tests will be carried out for 100 hours. Fresh and spent catalysts will be studied using a complex of physicochemical methods to determine its composition, establish the causes of deactivation in the process, and predict catalytic activity.

## References

- [1] *Catal. Today* **2014**, 234, 91-99
- [2] *Catalysts* **2019**, 9(10), 796
- [3] *J. Mol. Catal. A Chem.* **2006**, 246(1-2), 18-23



## SYNTHESIS AND SOME PROPERTIES OF 3-ALKYNYL-4-PYRONES

*Syrovsky D.V.<sup>1</sup>, Fedin V.V.<sup>1</sup>, Usachev S.A.<sup>1</sup>, Sosnovskikh V.Ya.<sup>1</sup>*

<sup>1</sup> Ural Federal University, Ekaterinburg, Russia

Student

[d.v.syrovsky@urfu.ru](mailto:d.v.syrovsky@urfu.ru)

Heteroaryl bromides are widely used in cross-coupling reactions to produce multifunctional structures, implementing a convergent approach in the development of compound libraries. However, direct bromination of heterocycles, especially of an acceptor nature, can be difficult. In our work, we investigated possible ways to produce 3-bromo-4-pyrones, which are planned to be converted into various condensed carbo- and heterocyclic compounds in the future. Three methods of obtaining target structures suitable are known from the literature. Direct bromination of the pyrone ring was possible in the case of donor 2,6-dimethyl-4-pyrone (**1a**) and ethyl comanate (**1b**). The bromination of triketone **2** was accompanied by simultaneous cyclization under the action of released hydrogen bromide. Tribromodiketones **3** were converted into target pyrones by the action of the bases. The latter reaction was optimized, and it was found that the best yield is obtained when using DBU in DMSO at room temperature for a long time (7-10 days).

During the Sonogashira reaction, it turned out that the donor 2,6-dimethyl derivative **4a** reacts poorly, and only alkyne dimerization occurred. The remaining pyrones **4b-g** having acceptor substituents reacted under standard conditions. Also, during research, some properties of 3-alkynyl-4-pyrones were discovered.

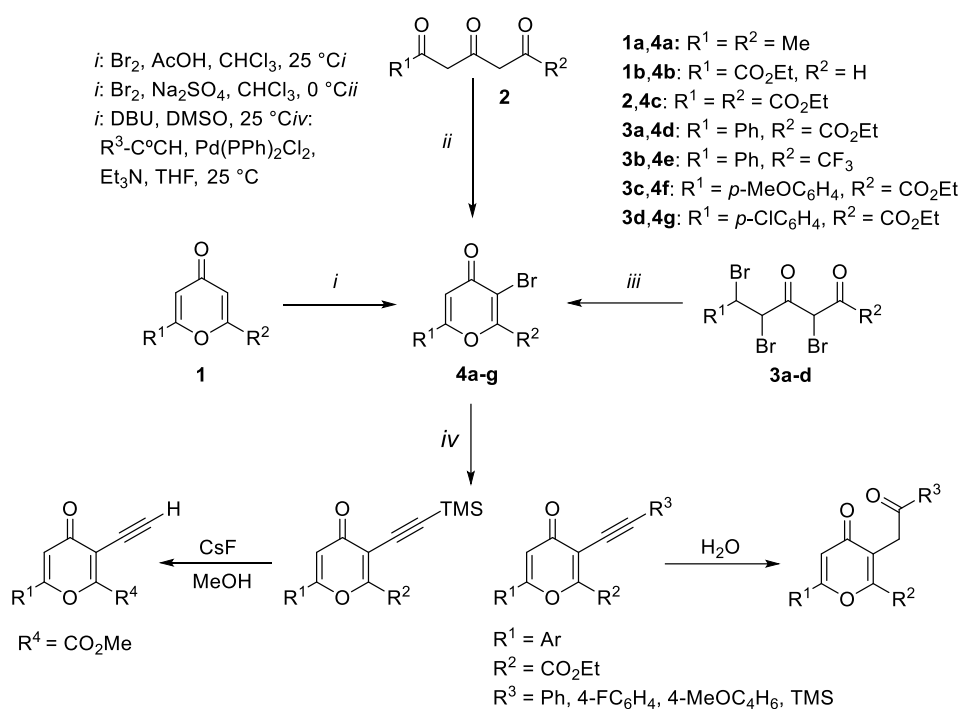

**Scheme 1.** Synthesis of 3-alkynyl-4-pyrones and their properties.



## DEVELOPMENT OF THE BiASO THRESHOLDER GATES MODULATED BY DIFFERENT CONCENTRATIONS OF THE CANCER MARKER

*Tafran L., Drozd V.S., Moustapha Y.N., Kolpashchikov D.M., Eldeeb A.A.*

Saint Petersburg National Research University of Information Technologies Mechanics and Optics, St. Petersburg, Russia

Master student, nucleic acid and nanobiotechnology laboratory

[tafran@scamt-itmo.ru](mailto:tafran@scamt-itmo.ru)

Gene therapy targeting vital housekeeping genes has emerged as one of the most promising approaches for cancer treatment, but it unfortunately lacks the necessary selectivity, impacting both cancerous and normal cells. In contrast, numerous studies have identified genes overexpressed in various human malignancies, such as HER-2 in breast cancer, B-Raf and MITF in melanoma, and KRAS, which is present in approximately 25% of tumors including lung, colorectal, and pancreatic cancers. Consequently, there is a growing demand for selective antisense oligonucleotide (ASO) therapy capable of distinguishing between cancerous and normal cells by targeting the overexpression of specific oncomarkers in cancer cells

Antisense oligonucleotide technology is one of the most successful gene therapy approaches, targeting specific sequences with complementary strands to induce targeted RNA cleavage via RNase H activity. This project focuses on developing antisense thresholder machines that target GFP-RNA as a model gene, activated by KRAS oncomarker. To delay activation in high concentrations of the marker, three designs of antisense thresholder machines were developed: (1) Yes gate Bi-ASO, consists of 2 strands ASO-a,b with main oncomarker binding site to be activated. (2) 2-input gate Bi-ASO consists of 2 strands ASO-a and ASOb with main marker-binding site and in absence of oncomarker, ASO-a forms a loop with itself and needs another KRAS molecule to unwind it . 2 input BiASO requires twice as much concentration. (3)3-input gate Bi-ASO consists of 2 strands ASO-a and ASO-b, both of them form a loop with themselves so it requires three times as much concentration. These designs were tested in vitro with recombinant RNase H enzyme, using 1  $\mu$ M of targeted RNA and 50 nM of Bi-ASO in commercial buffer across a concentration range of 0-1000 nM of a 29-nucleotide KRAS fragment. Activation ratios were approximately 1:1 for Yes gate Bi-ASO, 1:2 for 2-input gate Bi-ASO, and 1:3 for 3-input gate Bi-ASO, with no activation observed in the absence of the oncomarker.

In conclusion, this new technology addresses fundamental and applied problems of low selectivity in cancer gene therapy. Antisense thresholder machines offer a novel opportunity in cancer treatment by increasing selectivity for cancer cells and enhancing treatment efficiency. This project marks the first attempt to create an original antisense thresholder machine based on conventional antisense oligonucleotide technology.

### References

- [1] *Theranostics* **2022**, *12*, 7132-7157
- [2] *Angew. Chem., Int. Ed.* **2019**, *58*, 4654-4658

### Acknowledgements

The project was supported by project of ITMO University's priority 2030 Development strategy 922017.

DIVERGENT SYNTHESIS OF 2-AMINOQUINOLINES, 2-AMINOARYL-SUBSTITUTED CYCLOPROPANES AND CYCLOPROPA[C]QUINOLONES FROM ORTHO-AMINO-SUBSTITUTED BENZALDEHYDES

Tikhonov T.P.<sup>1</sup>, Shorohov V.V.<sup>1</sup>, Trushkov I.V.<sup>2</sup>, Ivanova O.A.<sup>1</sup>

<sup>1</sup> Moscow State University, Moscow, Russia

<sup>2</sup> N.D. Zelinsky Institute of Organic Chemistry, Moscow, Russia  
Student

[tikhonov-tim@mail.ru](mailto:tikhonov-tim@mail.ru)

Diversity-oriented synthesis (DOS) is a synthetic strategy involving facile preparation of collections of structurally distinct compounds from simple starting materials [1]. In this work, we used the reaction of *ortho*-NHTs-aldehydes **1** with C-H acids under diverse conditions to obtain a variety of nitrogen-containing compounds.

Firstly, we have developed a new three-component reaction of *ortho*-NHTs-benzaldehydes **1** with malonic esters and trialkyl phosphonoacetates under the reflux in toluene with amines and AcOH affording 2-aminoquinolines **2**, which are known as bioactive compounds [2].

Alternatively, the condensation of the same aldehydes **1** with malonic ester under mild conditions in the presence of TiCl<sub>4</sub> and pyridine produced alkenes as common Knoevenagel adducts. Their subsequent cyclopropanation results in a new, previously unexplored subclass of donor-acceptor cyclopropanes (DAC) **3**.

Finally, cyclization and subsequent cyclopropanation of the Knoevenagel adducts led to the formation of cyclopropa[c]quinolin-2-ones **4**, which contain a structural motif found in HIV-1 reverse transcriptase inhibitors [3].

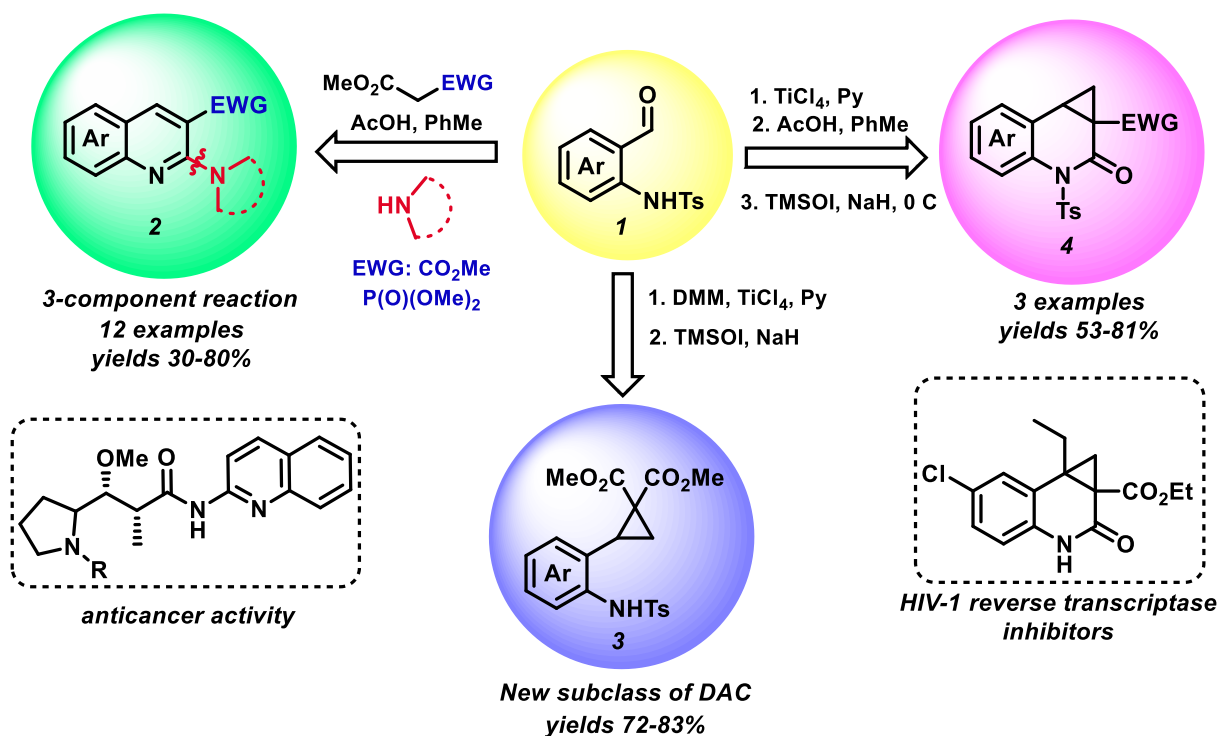

Scheme 1.

#### References

- [1] *Angew. Chem. Int. Ed.* **2004**, 43, 46  
 [2] *J. Nat. Prod.* **2011**, 74, 962  
 [3] *Bioorg. Med. Chem.* **2006**, 16, 4246

#### Acknowledgements

This work was supported by the Russian Science Foundation (project 21-73-20095).

## REACTIONS OF EPOXIDES OF ETHYL 5-ACYL-4-PYRONE-2-CARBOXYLATES WITH AMINES

*Titova P.K.<sup>1</sup>, Alikin N.A.<sup>1</sup>, Obydenov D.L.<sup>1</sup>, Steparuk E.V.<sup>1</sup>, Sosnovskikh V.Ya.<sup>1</sup>*

<sup>1</sup> Ural Federal University, Ekaterinburg, Russia

Student

[p.k.titova@urfu.ru](mailto:p.k.titova@urfu.ru)

3-Amino-2-pyrone-5-carboxylates are of interest for medical chemistry as compounds with anti-inflammatory and analgesic activity. Besides, these molecules found application in organic synthesis for the construction of substituted benzenes and pyridones.

Previously, our group developed a method for the synthesis of epoxides of ethyl 5-acyl-4-pyrone-2-carboxylates **1**, which can undergo opening of both pyrone and oxirane rings to form hydroxylated 4-pyrone-2-carboxylates, 2-pyrone-5-carboxylates or furans [1].

In this work, transformations of epoxides **1** with amines were studied for the construction of 2-pyrone-5-carboxylates bearing the amino group. The reaction proceeded as a Michael addition with subsequent deformylation and the formation of corresponding 3-amino-5-hydroxy-2-pyrone-4-carboxylates **2**. It was found that the optimal reaction conditions for aliphatic amines are stirring in EtOH at 0 °C for 2 h. Various N-nucleophiles, such as amino acids, aromatic and cyclic amines, can be used in the selective transformation. Product yields ranged from moderate to high, depending on both the structure of the amine and the acyl substituent.

The prepared 5-hydroxy-3-amino-2-pyrone-4-carboxylates **2** are polyfunctional molecules and can subsequently be used to obtain nitrogen-containing heterocycles.

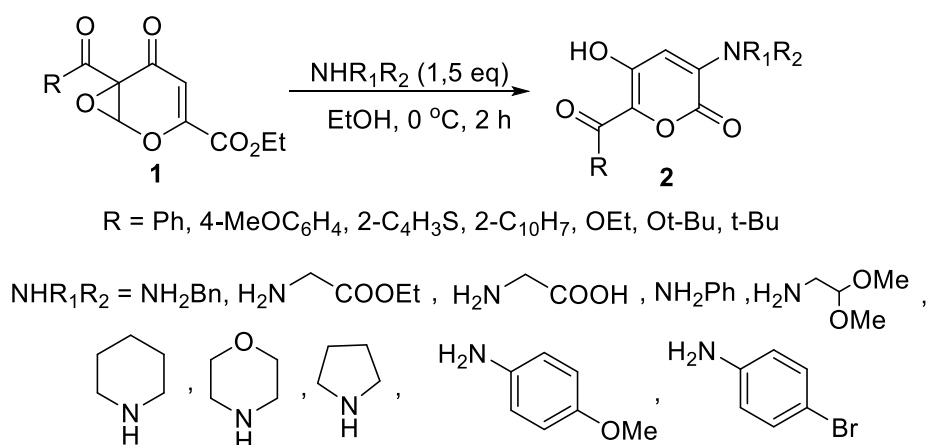

**Scheme 1.** Reaction of epoxides of ethyl 5-acyl-4-pyrone-2-carboxylates with amines.

### References

[1] *J. Org. Chem.* **2023**, *88*, 11590

# NOVEL 9-O BERBERINE DERIVATIVES AS TYROSYL-DNA PHOSPHODIESTERASE 1 INHIBITORS

*Valutsa N.<sup>1</sup>, Gladkova E.<sup>1,2</sup>, Chepanova A.<sup>3</sup>, Zakharenko A.<sup>3</sup>, Luzina O.<sup>2</sup>, Salakhutdinov N.<sup>2</sup>, Lavrik O.<sup>1,3</sup>*

<sup>1</sup> Novosibirsk State University, Novosibirsk, Russia

<sup>2</sup> N. N. Vorozhtsov Novosibirsk Institute of Organic Chemistry, Siberian Branch of the Russian Academy of Sciences, Novosibirsk, Russia

<sup>3</sup> Novosibirsk Institute of Chemical Biology and Fundamental Medicine, Siberian Branch of the Russian Academy of Sciences, Novosibirsk, Russia

Student

[n.valutsa@q.nsu.ru](mailto:n.valutsa@q.nsu.ru)

Berberine **1** is an isoquinoline plant alkaloid which exhibits a variety of biological activities. Anticancer activity is one of the most important properties of berberine and its derivatives. A promising strategy to enhance the efficacy of anticancer therapy includes the inhibition of various DNA repair enzymes, which counteract the effect of many anticancer drugs. Tyrosyl-DNA phosphodiesterase 1 (Tdp1) is a DNA reparation enzyme that removes adducts of various origins from the 3'-end of DNA. This enzyme is one of the reasons for the resistance of tumor cells to chemotherapy, and therefore is a promising target for antitumor therapy. Tdp1 inhibitors in combination with topoisomerase inhibitors can be used for cancer treatment. It was previously shown that berberine and tetrahydroberberine 9-O-sulfonates and their brominated analogues have potential as inhibitors of Tdp1 [1].

We have synthesized a series of novel 9-O-berberine derivatives containing an amide substituent (scheme 1). Among the derivatives containing an acetic acid amide fragment at position 9, only derivatives **5** with aromatic substituents ( $R^1, R^2 = \text{Ar}$ ) and hydrogenated ring C were active ( $\text{IC}_{50} = 0.33\text{--}3.52 \mu\text{M}$ ). For derivatives **4** with native isoquinoline moiety or an aliphatic amide fragment at position 9, the  $\text{IC}_{50}$  values are  $>15 \mu\text{M}$ .

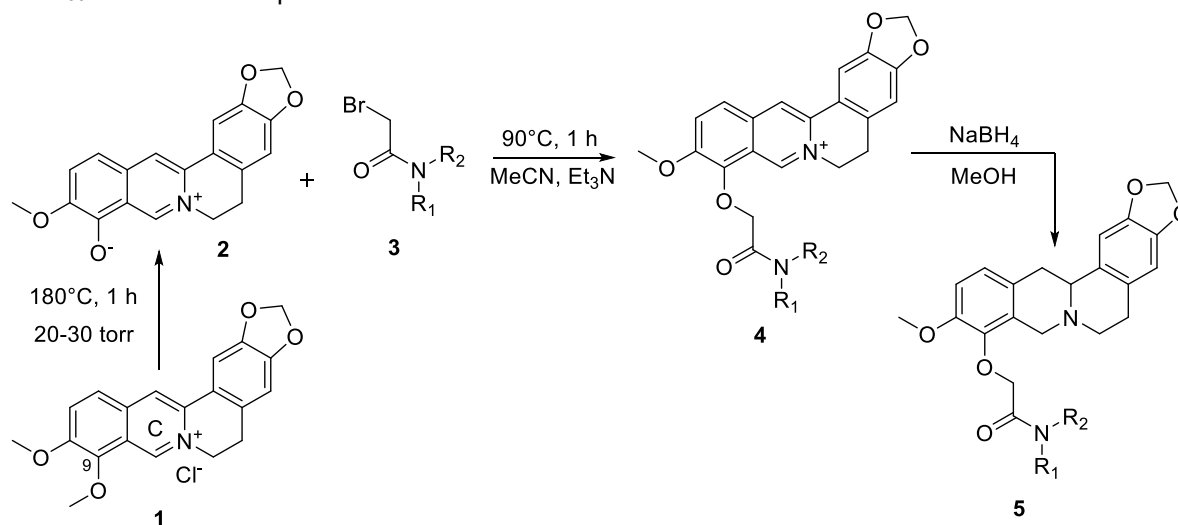

**Scheme 1.** Synthesis of novel 9-O berberine derivatives.

## References

[1] *Int. J. Mol. Sci.* **2020**, *21*(19), 7162

# HYDROGENATION OF O-H INSERTION PRODUCTS OF TERPENE ALCOHOLS WITH 5-ARYL-1-ARYLSULFONYL-1,2,3-TRIAZOLES

*Vasilchenko D.S.*<sup>1,2</sup>, *Rostovsky N.V.*<sup>2</sup>, *Trishin Yu.G.*<sup>1</sup>

<sup>1</sup> St. Petersburg State University of Industrial Technologies and Design, St. Petersburg, Russia

<sup>2</sup> St. Petersburg State University, St. Petersburg, Russia

Postgraduate

[dima.vasilchenko.06@mail.ru](mailto:dima.vasilchenko.06@mail.ru)

Synthetic transformations of natural compounds, particularly terpene alcohols, to create biologically active substances is one of the significant and fruitful fields of organic and medicinal chemistry. Recently, through the reactions of p-menthol, isborneol, and allobetulin **1** with 5-aryl-1-arylsulfonyl-1,2,3-triazoles **2**, sources of azavinylcarbenes, we have obtained 2-terpenyloxy-2-arylethenylsulfonamides **3**. Previously, there was only one example of a p-menthol insertion reaction in the literature [1]. These compounds contain two pharmacophoric groups, terpenyloxy and ethenylsulfonamide. Unfortunately, many of the obtained products **3** turned out to be unstable, and therefore in this work we converted them into more stable derivatives **4** by hydrogenating the C=C bond of enamide fragment. N-2-aryl-2-terpenyloxyethylsulfonamides **4** are interesting as potential pharmaceutical agents.

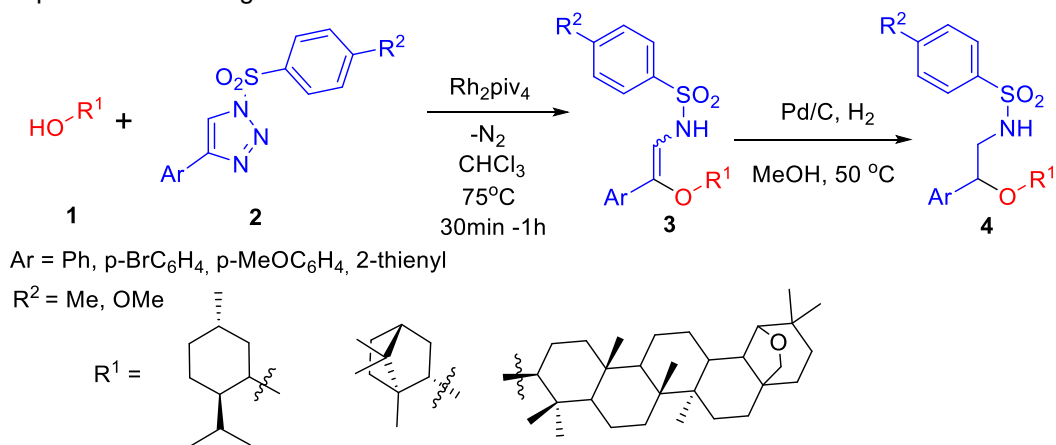

**Scheme 1.** Synthesis of sulfonamides **4**.

The composition and structure of compounds **4**, obtained in yields of 58-89%, were confirmed using mass spectrometry and <sup>1</sup>H, <sup>13</sup>C NMR spectroscopy, performed at the resource center of St. Petersburg State University.

## References

[1] *J. Am. Chem. Soc.* **2014**, *136*, 195

## Acknowledgements

This work was supported by the Russian Science Foundation (project No 22-73-10184).

## [3+2]-DIPOLAR CYCLOADDITION OF 1,2,3-TRIAZOLE *N*-OXIDES TO ARYNES

*Vasileva M.S.*<sup>1</sup>, *Semenov A.V.*<sup>1</sup>, *Baykov S.V.*<sup>1</sup>

<sup>1</sup> St. Petersburg State University, St. Petersburg, Russia  
Student

[marina02b@gmail.com](mailto:marina02b@gmail.com)

Phenols with azaheterocyclic substituents in the second position have quite a wide range of application due to their antibacterial, anti-inflammatory, antiviral and antitumor properties [1,2]. Structures containing one or two nitrogen atoms are attractive because they have greater polarity compared to their diphenyl analogs. Such compounds are already actively used as biological agents because of the possibility of non-covalent interactions (hydrogen bonding or  $\pi$ -stacking). However, only one example of synthesis of phenol that contains 2-aryl-2*H*-1,2,3-triazole moiety at position 2 is mentioned in the literature [3].

In this work, we report a method for the synthesis of 2-(2-aryl-2*H*-1,2,3-triazol-4-yl)phenols via a [3+2]-dipolar cycloaddition reaction between 2-aryl-2*H*-1,2,3-triazol-*N*-oxides, they act as dipoles, and an aryne, which is formed *in situ* from 2-(trimethylsilyl)phenyl trifluoromethanesulfonate (Scheme 1). The methodology was developed on the basis of the most common conditions for a similar reaction involving the closest analogs of triazoles - pyridines and pyrazoles. The yield of 2-(2-aryl-2*H*-1,2,3-triazol-4-yl)phenols under optimized conditions was 89%. A representative series of substituted phenols with yields of 45-75% was also synthesized and characterized.

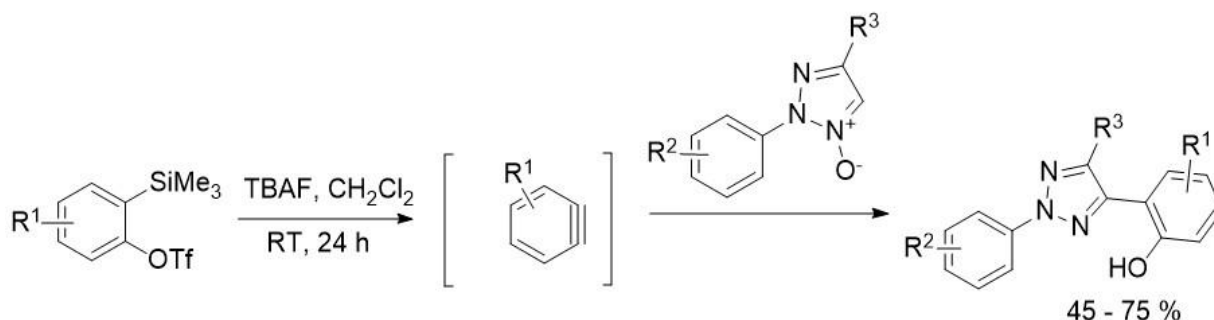

**Scheme 1.** Synthesis of 2-(2-aryl-2*H*-1,2,3-triazole-4-yl)phenols.

### References

- [1] *Bioorg Med Chem.* **2019**, *27*, 880
- [2] *Bioorg Med Chem Lett.* **2008**, *18*, 4486
- [3] *Monatshefte for Chemie.* **1969**, *100*, 602

### Acknowledgements

This work was supported by the Russian Science Foundation (project № 22-73-10031). Physicochemical studies were performed at the Center for Magnetic Resonance, Center for X-ray Diffraction Studies, Center for Chemical Analysis and Materials Research (all belonging to Saint Petersburg State University).



## BRET IN BIOLUMINESCENT SYSTEM OF EARTHWORMS *HENLEA* SP.

*Vavilov M.V.*<sup>1,3</sup>, *Petushkov V.N.*<sup>2</sup>, *Rodionova N.S.*<sup>2</sup>, *Khokhlova A.N.*<sup>1,4</sup>, *Zagitova R.I.*<sup>1</sup>, *Dubinnyi M.A.*<sup>1,5</sup>,  
*Yampolsky I.V.*<sup>1,6</sup>

<sup>1</sup> Shemyakin-Ovchinnikov Institute of Bioorganic Chemistry of the RAS, Moscow, Russia

<sup>2</sup> Institute of Biophysics, Krasnoyarsk Research Center, Siberian Branch, RAS, Krasnoyarsk, Russia

<sup>3</sup> National Research University Higher School of Economics, Moscow, Russia

<sup>4</sup> Lomonosov Moscow State University, Moscow, Russia

<sup>5</sup> Moscow Institute of Physics and Technology (State University), Dolgoprudny, Russia

<sup>6</sup> Pirogov Russian National Research Medical University, Moscow, Russia

Graduate student, Master

[vavmat1996@gmail.com](mailto:vavmat1996@gmail.com)

Bioluminescent earthworms *Henlea* sp. have been known since 2002 [1]. These species were found in Siberia and analysis of their bioluminescent system showed that it is unique, as none of its components cross-reacted with components of other systems. Some of the interesting features of this system is that one of its activators is calcium, and the light emitter is a cofactor structurally different from luciferin.

During the study of the bioluminescent system of *Henlea* sp. we found that its low-molecular components are: luciferin (which has a tryptophan fragment), oxygen, calcium cations, activators H and S - light emitters, based on spectral data [2], and a large number of low-molecular compounds - Peaks 300 (named so by the characteristic UV absorption maximum) [3]. The compounds in this series have different chromatographic mobility, but they have almost identical spectral data and all have tryptophan-2-carboxylate in their structure. Because of some structural similarity with luciferin, we assumed that one of the peaks of 300 is oxyluciferin in this system.

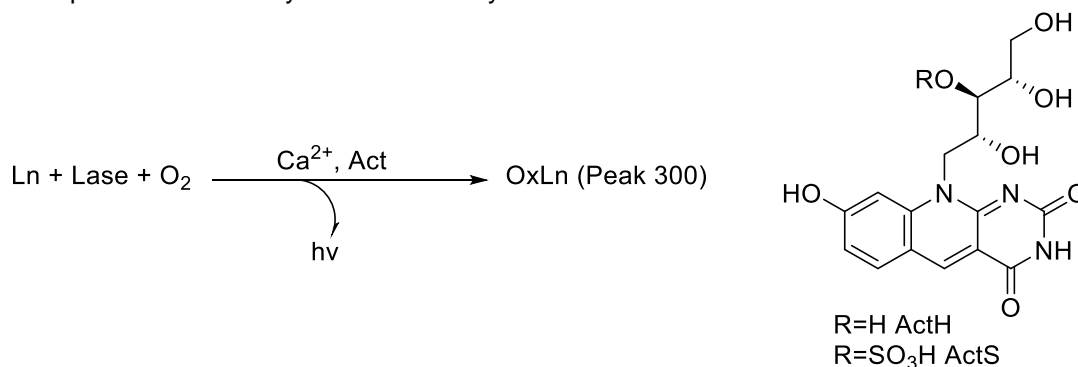

**Scheme 1.** Bioluminescent reaction of *Henlea* sp.

To test the hypothesis that *Henlea* sp. oxyluciferin does belong to the Peak 300 group, we performed a bioluminescence reaction without the H activator. The luminescence maximum we observed coincided with the emission maximum of the simplest of the Peaks 300 - tryptophan-2-carboxylate (Peak 300 Simple). Its emission maximum, in turn, coincides with the excitation maximum of the Activator H. All these observations in combination allow us to conclude that *Henlea* sp. oxyluciferin has tryptophan-2-carboxylate in its structure and belongs to the Peaks 300 group. During the bioluminescence reaction it carries out Förster resonance energy transfer to Activator H, which increases the luminescence intensity about 40 times and changes the bioluminescence maximum [4].

### References

- [1] *Doklady Biological Sciences* **2002**, 385, 310-312
- [2] *Org. Biomol. Chem.* **2023**, 21, 415-427
- [3] *ChemistrySelect* **2020**, 5(42), 13155-13159
- [4] *Biochemical and Biophysical Research Communications* **2024**, 708, 149787

### Acknowledgements

This work was supported by the Russian Science Foundation (project No 24-14-00421).

# DEVELOPMENT OF CYCLOALKYNE DYE REAGENTS: ROLE OF THE NATURE OF ALKYNE AND LINKER PART

*Vidyakina A.A.<sup>1</sup>, Silonov S.A.<sup>1</sup>, Danilkina N.A.<sup>1</sup>*

<sup>1</sup> St. Petersburg State University, St. Petersburg, Russia

PhD Student

[vidyakina.aleksandra@mail.ru](mailto:vidyakina.aleksandra@mail.ru)

Bioorthogonal chemistry is a modern field of research that aims to study complex biological systems using bioorthogonal click reactions [1]. Strain-promoted azide-alkyne cycloaddition (SPAAC) is one of the most widely used bioorthogonal transformations that allows visualization of different biomolecules through fluorescent labelling in vitro and vivo [2]. Although a wide variety of cycloalkyne-dye conjugates have been developed, the cycloalkyne nature and the nature of the linker unit for a dye attachment are often overlooked. However, neglecting the cycloalkyne and the linker nature by using only commercially available cycloalkyne-dye reagents can lead to nonspecific fluorescence response because of possible alkyne-thiol chemistry and, consequently, to the overestimation of the results.

To demonstrate the importance of both the alkyne and the linker nature for the alkyne-dye probes for intracellular bioimaging, here we synthesized several conjugates of benzotriophene-fused azacycloalkyne **BT9N** [3] and BODIPY dyes using the amide (**BT9N-BDP FL**) and the thiourea linker (**BT9N-TU-BDP FL**, **BT9N-TU-BDP Th**), and compared the behavior of these reagents with known BODIPY-alkyne reagents **BCN-** and **DBCO-BDP FL** in both N<sub>3</sub>-labeled and N<sub>3</sub>-non-labeled HeLa cells.

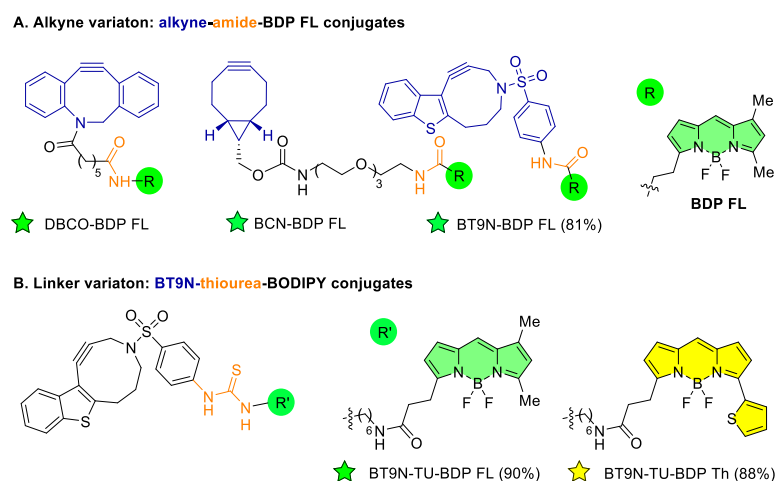

**Figure 1. A. Cycloalkyne core variation. B. Linker part variation.**

We discovered that for the visualization of intracellular N<sub>3</sub>-glycoconjugates the nature of cycloalkyne is dramatically important. While **DBCO-BDP FL** and **BCN-BDP FL** showed high non-specific response during intracellular visualization of N<sub>3</sub>-labeled cells, the synthesized **BT9N-BDP FL** gave excellent N<sub>3</sub>-specific fluorescent signal (Fig 1. A). We also showed that the linker nature is of crucial importance too. Consequently, upon going from an amide linker to a thiourea linker, there was a notable decline in the N<sub>3</sub>-specificity (Fig 1. B). However, we proved, that both thiourea-linked alkyne-BODIPY conjugates accumulate in mitochondria in both N<sub>3</sub>-labeled and control HeLa cells.

In summary, we have shown that **BT9N-BDP FL** dye conjugate through the amide linker, which is less active in SPAAC than common **BCN** and **DBCO** reagents, is more preferable for intracellular N<sub>3</sub>-glycans visualization. On the other hand, the related thiourea-linked alkyne dyes **BT9N-TU-BDP** are highly promising mitotrackers, with potential applications in the development of new alkyne-based systems for the delivery of bioactive molecules to mitochondria. This work is submitted to ChemComm, 2024.

## References

- [1] *Chem. Rev.*, **2021**, 121, 6850
- [2] *Anal. Chem.*, **2022**, 94, 16614
- [3] *J. Am. Chem. Soc.*, **2021**, 143, 16519

## Acknowledgements

This work was supported by the Russian Science Foundation (project No 24-23-00377).

# SYNTHESIS OF PYRAZOLO[4,3-*c*]PYRIDINES BASED ON THE AMINATION OF 4-PYRIDONES

Viktorova V.V.<sup>1</sup>, Obydenov D.L.<sup>1</sup>, Sosnovskikh V.Y.<sup>1</sup>

<sup>1</sup> Ural Federal University, Ekaterinburg, Russia

PhD Student

[viktoria.viktorova@urfu.ru](mailto:viktoria.viktorova@urfu.ru)

Pyrazolo[4,3-*c*]pyridines are important substrates for medicinal chemistry [1] as anticancer and anti-HIV agents. However, methods for their synthesis remain rather limited. Therefore, there is a need to find new building blocks and efficient synthetic tools for the design and construction of the polycyclic structures.

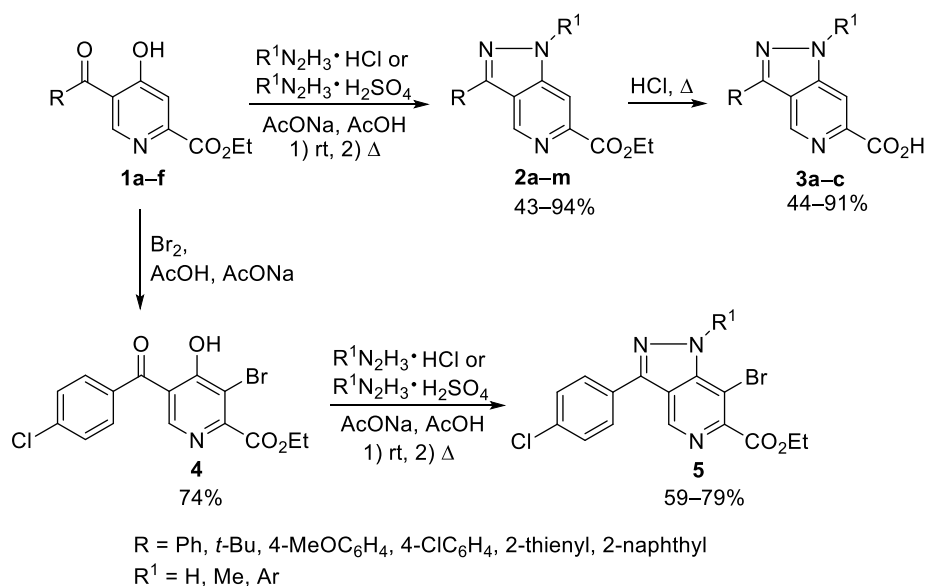

**Scheme 1.** Synthesis of pyrazolo[4,3-*c*]pyridines.

In this work, we decided to use 5-acyl-4-pyridones as starting molecules. 4-Pyridones **1** are usually low-active compounds and there are scarce data on their nucleophilic transformations. The electron-withdrawing acyl substituent activates the pyridone ring, thereby promoting a variety of transformations. We found that the reaction of compounds **1** is accompanied by intramolecular amination of the pyridone ring and the formation of target pyrazolo[4,3-*c*]pyridines in 43–94%. Pyrazolopyridines can be modified by hydrolysis in the presence of hydrochloric acid to produce carboxylic acids **3**. Bromination of pyridone **1a** led to bromopyridone **4**, which underwent the amination reaction to form bromo-substituted pyrazolopyridines **5**.

Prepared *N*-aryl-substituted pyrazolo[4,3-*c*]pyridines demonstrated antitumor activity.

## References

[1] *J. Med. Chem.* **2017**, *60*, 4458–4473

## Acknowledgements

This work was supported by the Russian Science Foundation (RSF No 22-73-10236).

# HOVEYDA-GRUBBS RUTHENIUM CATALYST CONTAINING TRIDENTATE BENZYLIDENE LIGAND

*Volchkov N.S.*<sup>1</sup>, *Logvinenko N.A.*<sup>1</sup>, *Antonova A.S.*<sup>1</sup>, *Vasilyev K.A.*<sup>1</sup>, *Zubkov F.I.*<sup>1</sup>

<sup>1</sup> Peoples' Friendship University of Russia, Moscow, Russia  
Student  
[volchkovns@gmail.com](mailto:volchkovns@gmail.com)

Six-membered ruthenium chelate complexes exhibiting great catalytic activity in the metathesis olefin reaction have already been described in our previous works [1]. However, the air- and moisture-stable resulting complexes have an incomplete 16-electron shell. As previously reported [2, 3], there are Hoveyda-Grubbs type catalysts, containing in the arylidene ligand an additional heteroatom capable of forming an coordination bond and, as a result, a second chelate ring. The unusual structure of bichelate ruthenium catalysts not only attracts researchers even today, but also makes it possible to significantly expand the possibilities for catalyst design.

The presented research is aimed at developing methods for the preparation of new 2nd generation Hoveyda-Grubbs type catalysts containing tridentate benzylidene ligands, as well as identifying the dependence describing the change in catalytic activity when varying such coordinating atoms of p-elements as O, S, N (Scheme 1).

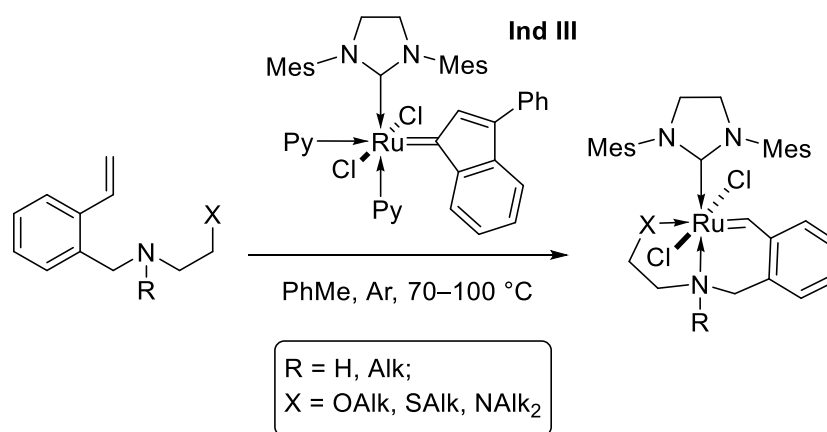

**Scheme 1.** Synthesis of target Hoveyda–Grubbs type catalysts.

## References

- [1] *Molecules* **2023**, *145*, 1188
- [2] *Angew. Chem. Int. Ed.* **2007**, *145*, 7206
- [3] *ACS Catal.* **2017**, *7*, 4115

## Acknowledgements

This work has been supported by the RUDN University Scientific Projects Grant System, project № 021409-2-000.

# SYNTHESIS OF 3-ARYLSUBSTITUTED 4,5,6,7-TETRAHYDRO-[1,2,3]TRIAZOLO[1,5-a]PYRASINES WITH CATALYST-FREE AZIDE-ALKYNE CYCLOADDITION

*Weber.D.I.<sup>1</sup>, Sapegin A.V.<sup>1</sup>*

<sup>1</sup> St. Petersburg State University, St. Petersburg, Russia

Student

[daniilveb@mail.ru](mailto:daniilveb@mail.ru)

According to results of quantum-chemistry calculation obtained from our colleagues, 3-phenyl-4,5,6,7-tetrahydro-[1,2,3]triazolo[1,5-a]pyrazine is supposed to be a promising substrate for TAAR1-receptor with satisfactory cell permeability and peroral intake. Inhibition of TAAR1-receptor is now considered as a possible way for treatment of range of neuropsychiatric and neurodegenerative disorders like schizophrenia, Parkinson disease and depression, what means that 3-phenyl-4,5,6,7-tetrahydro-[1,2,3]triazolo[1,5-a]pyrazines can be used for small molecules based drugs against these diseases [1,2]. Here we are demonstrating a method for obtaining 3-(het)aryl-4,5,6,7-tetrahydro-[1,2,3]triazolo[1,5-a]pyrazines based on azide-alkyne cycloaddition.

The common protocol of synthesis is shown on Scheme 1. Firstly, amino group of propargylamine was protected with nosyl and then aryl or hetaryl group were inserted instead of alkynyl proton with Sonogashira reaction. To its product were added O-tosyl substituted 2-azido-ethanol, which was obtained with nucleophilic substitution of chlorine by azido-group in 2-chloro-ethanol with subsequent tosylation of hydroxyl. Substitution of proton in sulfonamide and cyclisation were performed in one step without usage of Cu<sup>2+</sup> catalyst. Conditions for this reaction were optimized for 4,5,6,7-tetrahydro-[1,2,3]triazolo[1,5-a]pyrazine. At the last step, nosyl protection was removed by thiophenol and desired 3-(het)aryl-4,5,6,7-tetrahydro-[1,2,3]triazolo[1,5-a]pyrazines were obtained.

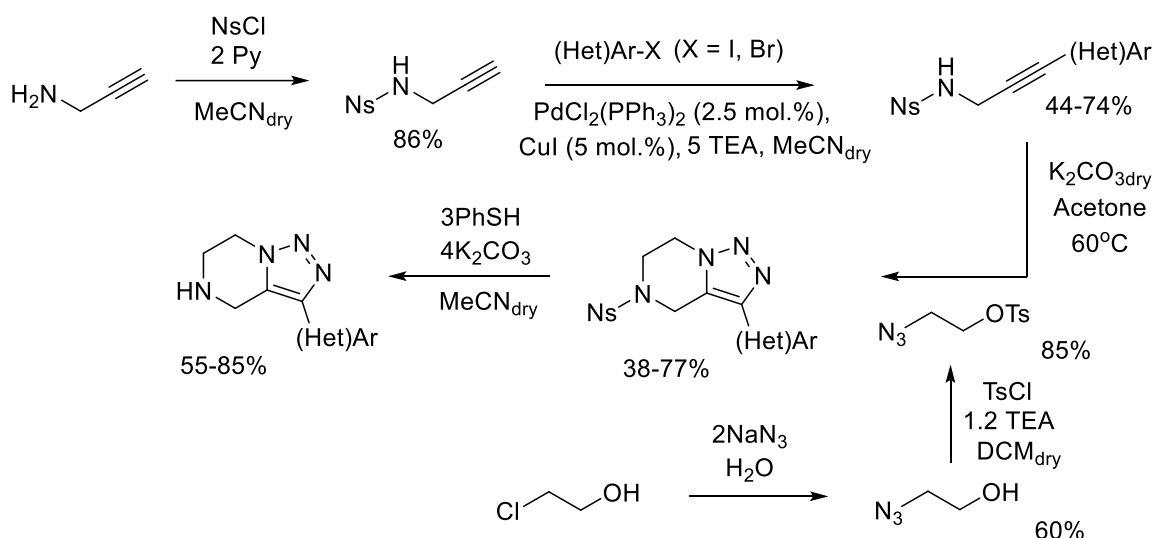

**Scheme 1.** Synthesis of 3-(het)aryl-4,5,6,7-tetrahydro-[1,2,3]triazolo[1,5-a]pyrazines.

Products thus obtained were characterized with <sup>1</sup>H NMR spectroscopy and high-resolution mass-spectrometry. Their binding affinity to TAAR1 receptor is now investigated.

## References

- [1] *Pharmacol. Rev.* **2016**, 70, 549  
 [2] *Trends Neurosci.* **2023**, 46, 60

## Acknowledgements

This research was funded by the Russian Science Foundation (project No 19-75-30008-P).

PEROXIDES OF POLYUNSATURATED FATTY ACIDS AS SUBSTRATES IN BIOLUMINESCENCE  
SYSTEM OF MARINE POLYCHAETE  
CHAETOPTERUS VARIOPEDATUS

*Zagitova R.I.*<sup>1</sup>, *Purtov K.V.*<sup>2</sup>, *Shcheglov A.S.*<sup>1</sup>, *Belozeroва O.A.*<sup>1</sup>, *Yampolsky I.V.*<sup>1</sup>

<sup>1</sup> Shemyakin-Ovchinnikov Institute of Bioorganic Chemistry RAS, Moscow, Russia

<sup>2</sup> Institute of Biophysics, Krasnoyarsk Research Center, Siberian Branch RAS, Krasnoyarsk, Russia  
PhD student

[zagitova.renata97@gmail.com](mailto:zagitova.renata97@gmail.com)

*Chaetopterus variopedatus* is a marine polychaete worm that lives in U-shaped tubes. It is able to emit light and secrete luminescent mucus in response to mechanical stimulation [1].

It was previously considered that the bioluminescent system of *C.variopedatus* includes photoprotein, oxygen, Fe<sup>2+</sup> ions, hydrogen peroxide and 2 cofactors – additional protein and lipid-like substance [2]. Further kinetic studies have confirmed the luciferin-luciferase mechanism of the reaction [3], but luciferin has not yet been isolated, probably due to extremely low stability.

Three compounds demonstrating bioluminescent activity with the luciferase fraction of *C.variopedatus* in the presence of Fe<sup>2+</sup> ions were isolated from the algae *Chaetomorpha linum*. Analysis of NMR spectroscopy and HRMS spectrometry data revealed that all these substances are peroxides of polyunsaturated fatty acids. We synthesized a number of fatty acid peroxides, studied their bioluminescent activity and found that the presence of at least two double bonds in the acid structure is necessary for luminescence. We carried out a bioluminescent reaction of the synthesized substrates with the luciferase fraction of *C.variopedatus* and observed luminescence with the spectrum coinciding with the bioluminescence spectrum of *C.variopedatus* [4].



**Scheme 1.** Bioluminescence reaction of *C.variopedatus* with synthesized substrates.

HRMS analysis of the products of the bioluminescent reaction with various synthesized substrates did not allow us to find any components capable of fluorescence. Since no fluorescent cofactors are known for this bioluminescent system as in the bacterial or earthworm *Henlea sp.* systems [5], its mechanism is unclear and needs further investigation.

We believe that our study of the bioluminescent system of *C.variopedatus* may lead to the development of new analytical tools for the analysis of reactive oxygen species in living cells.

#### References

- [1] *Photochemistry and Photobiology*, **2020**, 96, 768-778
- [2] *Science*, **1968**, 159(3820), 1239-40
- [3] *Dokl. Biochem. and Biophys.*, **2019**, 486(1), 209-212
- [4] *Int. J. Mol. Sci.* **2023**, 24(11), 9466.
- [5] *Biochem. and Biophys. Res. Comm.* **2024**, 708, 149787

#### Acknowledgements

The work was carried out within the framework of the state assignment of the Ministry of Science and Higher Education of the Russian Federation (topic No. FFEU-2024-0009 "Approaches and strategies for the total synthesis of secondary metabolites of living organisms and their analogues for biotechnology and medicine").

# HETEROANNULATION OF 2-( $\alpha$ -DIAZOACYL)-2H-AZIRINES WITH AMIDINES IN DIAZO SYNTHESIS OF FUNCTIONALIZED NAPHTHO[1,2-*d*]IMIDAZOLES

Zanakhov T.O.<sup>1</sup>, Galenko E.E.<sup>1</sup>, Novikov M.S.<sup>1</sup>, Khlebnikov A.F.<sup>1</sup>

<sup>1</sup> St. Petersburg State University, St. Petersburg, Russia  
Postgraduate  
[st078891@student.spbu.ru](mailto:st078891@student.spbu.ru)

The imidazole ring is frequently found in the structures of biologically active compounds with antitumor, anti-inflammatory, and antioxidant properties [1]. Naphtho[1,2-*d*]imidazole derivatives, in particular, represent an important class of compounds with a diverse spectrum of biological activities, such as non-acid anti-inflammatory, antihypertensive, etc. [2]. However, there are practically no methods for the synthesis of these compounds with substituents on the naphthalene ring.

As part of our research aimed at developing diazo-azirine methods for the synthesis of heterocycles [1-3], in this work a new method for the synthesis of naphtho[1,2-*d*]imidazoles **3** was developed using a novel reaction between arylamidines and 2-( $\alpha$ -diazoacyl)-2H-azirines **1**. This reaction makes it possible to obtain 5-aryl-4-( $\alpha$ -diazoacyl)-1H-imidazoles **2** with good yield under mild conditions. The imidazoles **2** then undergo Wolf rearrangement under thermolysis, followed by 6 $\pi$ -cyclization of transient ketene to form 3H-naphtho[1,2-*d*]imidazoles **3**.

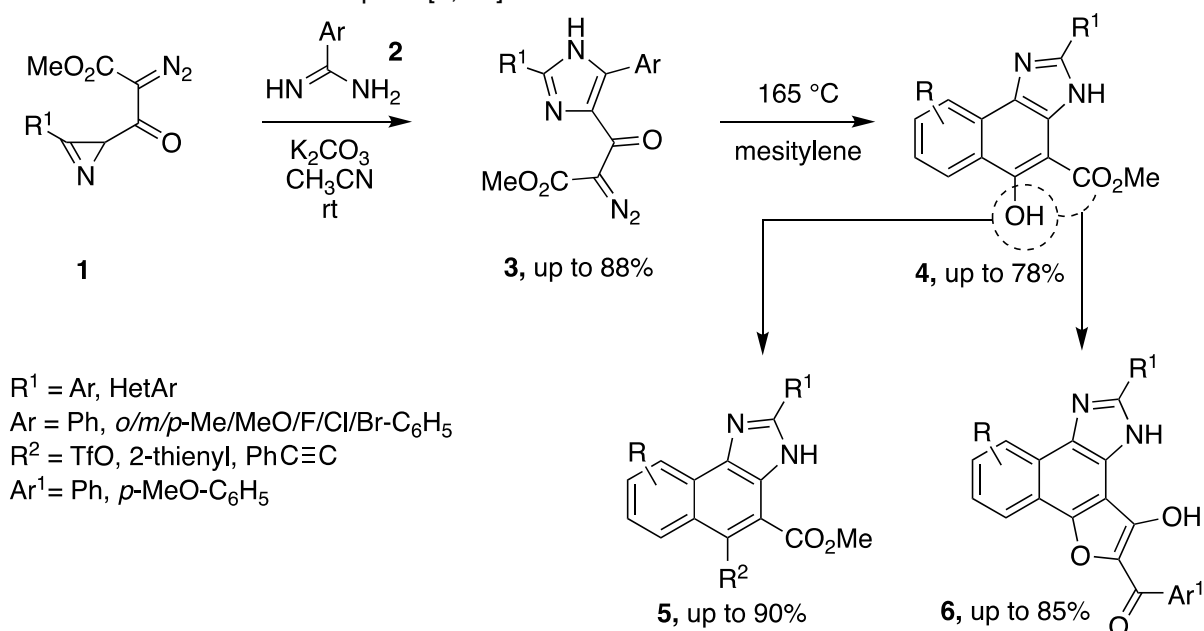

**Scheme 1.** Synthesis of Naphtho[1,2-*d*]imidazoles.

The strategy of benzene ring formation for the synthesis of naphtho[1,2-*d*]imidazoles makes it possible to obtain various substituents in the positions 2,3,4,5,7,8,9 of the target tricyclic structure from more accessible non-condensed systems. Substituents at the 5-position of methyl 5-hydroxy-3H-naphtho[1,2-*d*]imidazole-4-carboxylates can be easily varied by converting the hydroxyl group into triflate and its cross-coupling reactions (**5**). 3H-Furo[3',2':3,4]naphtho[1,2-*d*]imidazole derivatives **6** were easily constructed in a one-pot mode using alkylation with phenacyl bromides followed by base-induced intramolecular acyl substitution.

## References

- [1] *Molecules* **2023**, *28*, 838
- [2] *J. Med. Chem.* **1984**, *27*, 610
- [3] *J. Org. Chem.* **2023**, *88*, 13191
- [4] *J. Org. Chem.* **2022**, *87*, 15598
- [5] *Molecules* **2021**, *26*, 1881

## Acknowledgements

This work was supported by the Russian Science Foundation (project 22-13-00011).

NOVEL 2,4-DIMORPHOLINOQUINAZOLINE-BASED INHIBITORS OF  
PI3K-AKT-mTOR SIGNALING PATHWAY

*Zapevalova M.V.*<sup>1</sup>, *Fonareva I.P.*<sup>1</sup>, *Shchegravina E.S.*<sup>1</sup>, *Scherbakov A.M.*<sup>2</sup>, *Svirshchetskaya E.V.*<sup>3</sup>,  
*Fedorov A.Yu.*<sup>1</sup>

<sup>1</sup> Lobachevsky State University of Nizhny Novgorod, Nizhny Novgorod, Russia,

<sup>2</sup> Blokhin N.N. National Medical Research Center of Oncology, Moscow, Russia

<sup>3</sup> Shemyakin-Ovchinnikov Institute of Bioorganic Chemistry, Moscow, Russia

Graduate student

[maria.1999.zapevalova@gmail.com](mailto:maria.1999.zapevalova@gmail.com)

Excessive activation of the PI3K-AKT-mTOR signaling pathway is associated with the Warburg effect and promotes the survival and proliferation of cancer cells. A number of new 2,4-dimorpholinoquinazoline-based compounds were synthesized as potential inhibitors of the PI3K-AKT-mTOR pathway (Scheme 1).

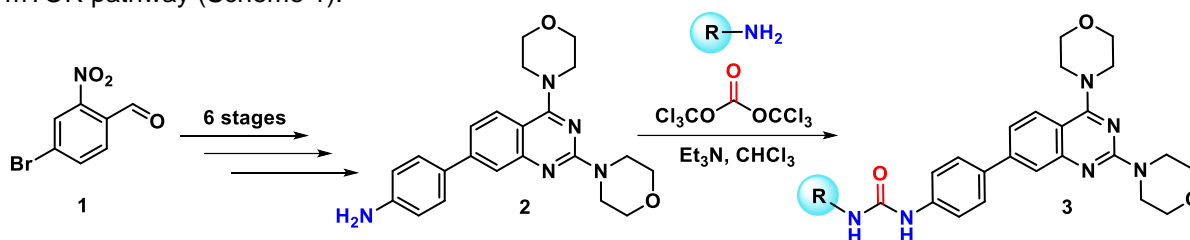

**Scheme 1.** Synthesis of potential inhibitors of the PI3K-AKT-mTOR signaling pathway.

The resulting compounds demonstrate antiproliferative activity towards the MCF7 and MDA-MB-231 cell lines in the micromolar and sub-micromolar concentration range. For the most active compounds, inhibition of key kinases in the signaling cascade (Figure 1) and the effect on the cell cycle were assessed. *In vivo* studies demonstrated an inhibition of tumor growth in the colorectal tumor model. Further biological studies and optimization of the inhibitor structure is ongoing.

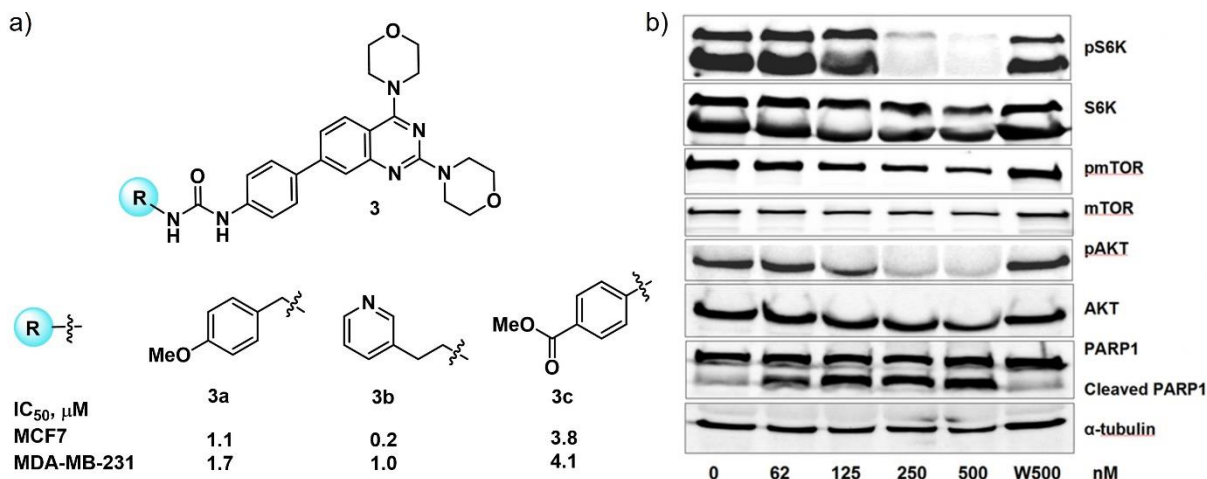

**Figure 1.** a) Structure of the most active compounds **3a-c**; b) Inhibition of phosphorylation of target cascade kinases.

### Acknowledgements

The research was carried out with financial support via State assignment in Research scientific laboratory of "Chemistry of natural products and their synthetic analogues" of Scientific Educational Centre "Technoplatfrom 2035", grant number FSWR-2024-0002.



## PROSPECTS FOR THE USE OF UNUSABLE DRUGS AS SYNTHONS IN ORGANIC SYNTHESIS

Zavyalova V.V.<sup>1</sup>, Slovesnova N.V.<sup>1,2</sup>, Petrov A. Yu.<sup>1,2</sup>, Vatolina S.E.<sup>2</sup>,  
Krinochkin A.P.<sup>2,3</sup>, Kopchuk D.S.<sup>2,3</sup>, Zyryanov G.V.<sup>2,3</sup>

<sup>1</sup> Ural state medical academy, Yekaterinburg, Russia

<sup>2</sup> Ural federal university, Yekaterinburg, Russia

<sup>3</sup> I.Ya. Postovsky Institute of Organic Synthesis of the Ural Branch of the Russian Academy of Sciences  
Student

[lera.zevyalova.199@gmail.com](mailto:lera.zevyalova.199@gmail.com)

Currently, the collection of expired drugs from the population is not organized in the Russian Federation; according to the survey, 82% of respondents dispose of drugs together with household waste [1]. The Russian Environmental Operator (REO) has taken the initiative to create a centralized system for the collection of expired medicines and their packaging by placing special containers in hospitals, clinics and pharmacies [2].

The extract prepared from two Favipiravir tablets and 50 ml of ethyl acetate showed the highest yield of the active substance (85.25%). The use of ethanol as a solvent also showed a high yield percentage for two tablets, Favipiravir (74.75%) and Umifenovir (73.50%).

Purity of compounds was proved by <sup>1</sup>H NMR spectra. Amount of impurities were less than 5% (mol.) for all samples.

An example of the synthesis of a potential fluorophore based on Favipiravir is represented in scheme 1. Thus, reaction with aryne generated in situ resulted in the isoquinoline **2**. The structure of product was proved by the data of <sup>1</sup>H, <sup>13</sup>C NMR and mass-spectra.

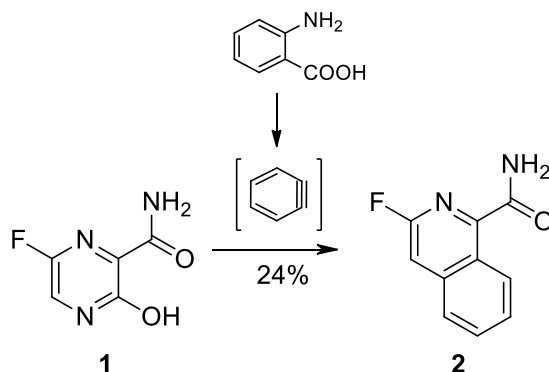

**Scheme 1.** Synthesis of a new fluorophore.

The yield of the product **2** was 24%.

### References

[1] Survey of visitors to St. Petersburg pharmacies on the problem of disposal of unused medicines // Scientific electronic library "CyberLeninka" URL: <https://cyberleninka.ru/article/n/opros-posetiteley-peterburgskih-aptok-po-probleme-utilizatsii-neispolzovannyh-lekarstvennyh-sredstv> (date of access: 02/20/2024).

[2] Letter of the Ministry of Health of the Russian Federation (Ministry of Health of the Russian Federation) No. 25–4/9317 dated September 20, 2023

### Acknowledgements

This work was supported by the Megagrant of the Ministry of Science and Higher Education of the Russian Federation (project No 075-15-2022-1118 dated June 29, 2022).

# ENAMINODIKETONES FROM 5-ARYLPENT-4-ENE-1,3-DIONES IN THE SYNTHESIS OF NITROGEN-CONTAINING HETEROCYCLES

*Zimnitskiy N.S.<sup>1</sup>, Kaigorodova V.V.<sup>1</sup>, Korotaev V.Y.<sup>1</sup>, Obydenov D.L.<sup>1</sup>, Sosnovskikh V.Y.<sup>1</sup>*

<sup>1</sup> Ural Federal University, Ekaterinburg, Russia

Associate professor, PhD in Chemistry

[n.s.zimnitskiy@urfu.ru](mailto:n.s.zimnitskiy@urfu.ru)

5-Arylpent-4-ene-1,3-diones **1** represent a scientifically important class of compounds due to the presence of highly reactive scaffolds in their structure – a double C=C bond conjugated with a 1,3-dicarbonyl group. This combination allows enediones to take part in numerous chemical reactions as nucleophiles, electrophiles and ambiphiles, where their usage leads to formation of various compounds possessing a variety of biological and physical properties. However, their applicability in the synthesis of six-membered heterocycles remains largely understudied [1].

As one of the means toward the obtaining of heterocyclic systems on the basis of 5-arylpent-4-ene-1,3-diones we have studied their derivatives – 2-((dimethylamino)methylene)-5-arylpent-4-ene-1,3-diones **2**. It has been determined that their consequent reamination by primary amines followed by an intramolecular cyclisation, results in the formation of dihydropyridones **4** in high yields. This process can also be performed *via* a one-pot procedure. Upon treatment of dihydropyridones **4** with *p*-chloranil, pyridones **5** are formed readily.

Reaction of enaminodiones **2** with 1 equiv. of arylhydrazines leads to monopyrazoles **6** that can react with an excess of the arylhydrazine and form dihydrobipyrazoles **7**.

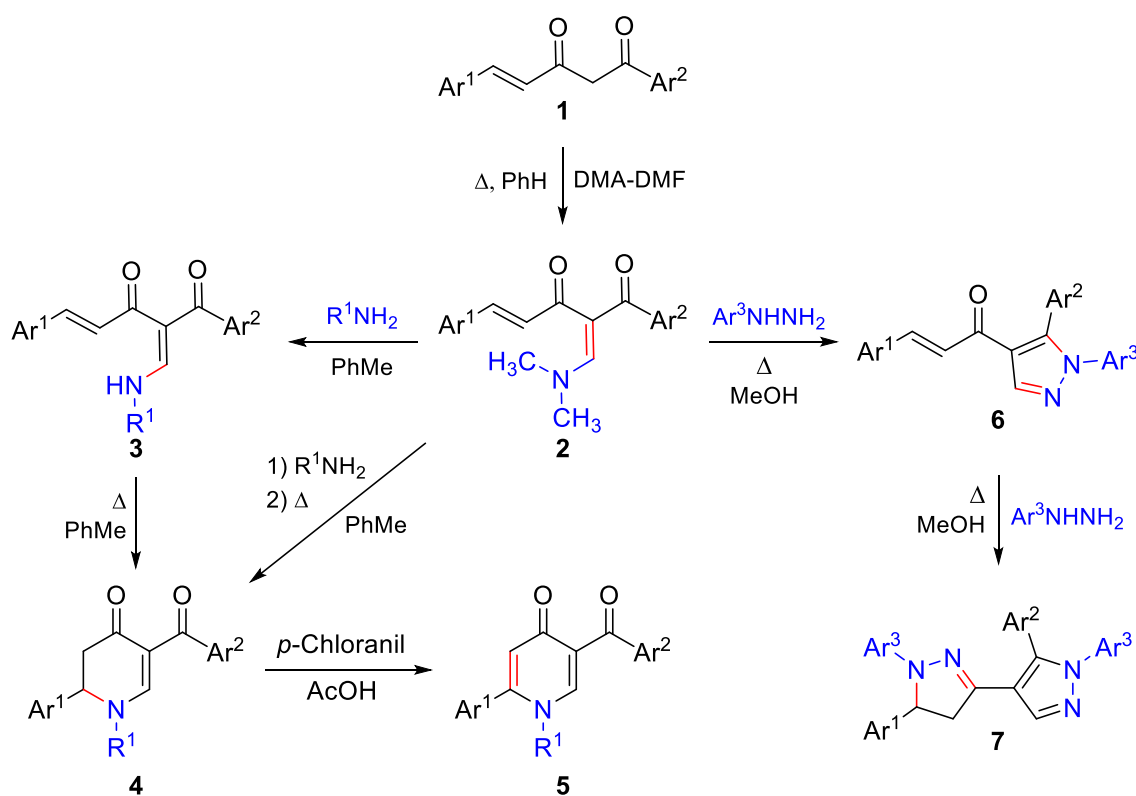

**Scheme 1.** Heterocycles obtained on the basis of enaminodiketones **2**.

It should also be noted that double bond of monopyrazoles **6** is conjugated with a carbonyl group and thus, such molecules are able to take part in the cycloaddition reactions.

## References

[1] *New J. Chem.* **2023**, 47, 5110

## Acknowledgements

This work was supported by the Ministry of Science and Higher Education of the Russian Federation (Ural Federal University Program of Development within the Priority-2030 Program).

# THE TRANSFORMATIONS OF HETEROCYCLIC COMPOUNDS IN REACTIONS WITH INTERNAL ALKYNES

Zinoveva A.D.,<sup>1</sup> Borisova T.N.<sup>1</sup>

<sup>1</sup> Peoples' Friendship University of Russia (RUDN University), Department of Organic Chemistry  
Moscow, Russia  
PhD student  
[anna.zinovieva96@gmail.com](mailto:anna.zinovieva96@gmail.com)

Currently, reactions with electron-deficient internal alkynes are of significant interest for the synthesis of new heterocyclic compounds. [1]

Previously, the possibility of obtaining indolizine and pyrrolo[2,1-*a*]isoquinoline derivatives from 2-arylpyridines and 1-arylisoquinolines with an imino-ketone fragment, with the participation of electron-deficient alkynes was demonstrated in the Department of Organic Chemistry of RUDN University.[2–3] In order to expand the synthetic boundaries of the domino reaction, we carried out an extensive study of the interaction in the series of 3,4-dihydrobenzo[*h*]isoquinolines, 6-arylphenanthridines, 6,7-dihydrothieno[3,2-*c*]pyridines, 4,9-dihydro-3*H*- $\beta$ -carbolines, 6*H*-pyrrolo[1,2-*a*][1,4]benzodiazepines with internal alkynes. In the process of research, optimization of synthesis conditions was carried out.

Thus, a new method was developed for the construction of a pyrrole ring based on a cycloaddition reaction involving an imino-ketone fragment of heterocyclic compound and internal alkynes with electron-withdrawing groups (dimethyl-, diethyl- acetylene dicarboxylates, dibenzoyl acetylene). It has been established that transformations can occur in two independent directions accompanied with skeletal rearrangement, leading to the synthesis of heterocyclic compounds of various structures. Pyrrole derivatives **2** containing a lactam fragment with a geminal arrangement of ester groups are predominantly formed if the reaction is carried out in ester or dioxane at room temperature. The usage of microwave irradiation for transformation or acetonitrile as solvent makes it possible to obtain derivatives of pyrrole **3** with a vicinal arrangement of functional groups. The reaction is accompanied with the transfer of the aryl fragment.

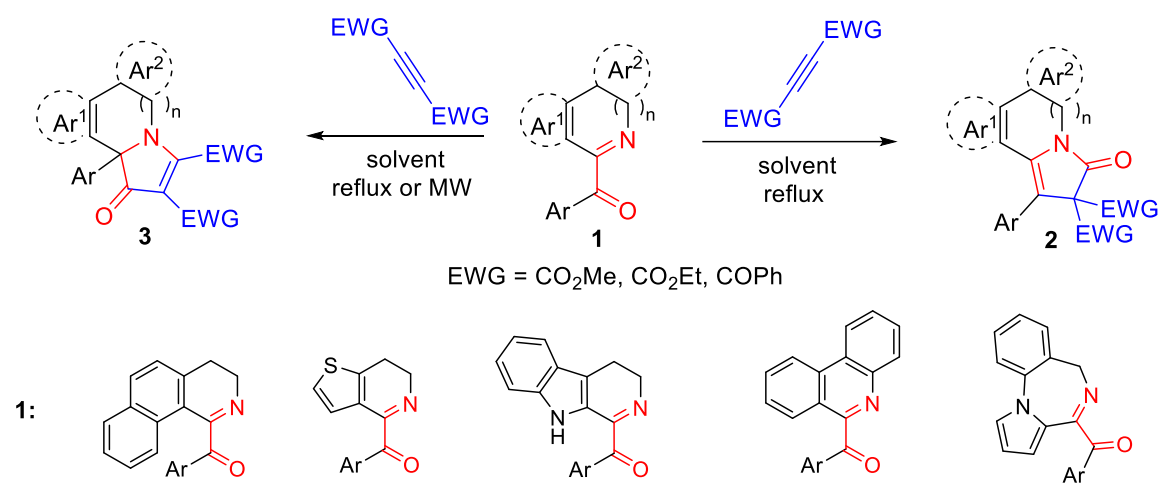

**Scheme 1.** Interaction of heterocyclic compounds with an imino-ketone fragment with internal alkynes.

The structure of the obtained compounds **2**, **3** was confirmed by a set of spectral data. Thus, it has been established that heterocyclic compounds of different structures can be obtained by varying the reaction conditions.

## References

- [1] *Synthesis* **2014**, 56, 537-585
- [2] *Tetrahedron Lett.* **2017**, 58, 877-879
- [3] *Tetrahedron Lett.* **2021**, 87, 153552



# **ABSENTEE PARTICIPANTS**

POLYSACCHARIDE PHOSPHATES IN THE FORM OF HYDROGELS AND MICROCAPSULES FOR DRUG DELIVERY

Aharodnikau U. E.<sup>1,2,3</sup>, Pristromova Y. I.<sup>1,2,3</sup>, Shauchenka M. A.<sup>1,3</sup>, Yedchyk A. V.<sup>2,3</sup>, Kaubasa M.A.<sup>2</sup>,  
Karcheuskaya A. G.<sup>2,3</sup>, Yurkshtovich T. L.<sup>1,2</sup>, Bychkovsky P. M.<sup>1,2</sup>

<sup>1</sup> Research Institute for Physical Chemical Problems of the Belarusian State University

<sup>2</sup> Belarusian State University

<sup>3</sup> Unitary Enterprise "UNITEHPROM BSU"

PhD student

[aharodnikau.u@gmail.com](mailto:aharodnikau.u@gmail.com)

Polysaccharides have unique physicochemical and biological properties, such as biocompatibility and biodegradability, therefore modified samples prepared from these biomaterials have found wide application in pharmaceuticals and medicine, agriculture, food industry and other fields. In addition, rich natural resources and low production costs offer them great potential for development.

Polysaccharides containing phosphoric acid groups are characterized by low toxicity parameters, and their structure is characterized by high sorption capacity and the ability to interact with low- and high-molecular biologically active substances with prolonged (controlled) release under *in vivo* conditions.

One of the most technologically acceptable esterifying compositions for the production of polysaccharide phosphates for medical use are mixtures of orthophosphoric acid-urea and tributyl phosphate - phosphoric acid - phosphorus oxide (v) - chloroform, which is due to the relative ease of complete removal of these components from the reaction zone after the end of the phosphorylation process.

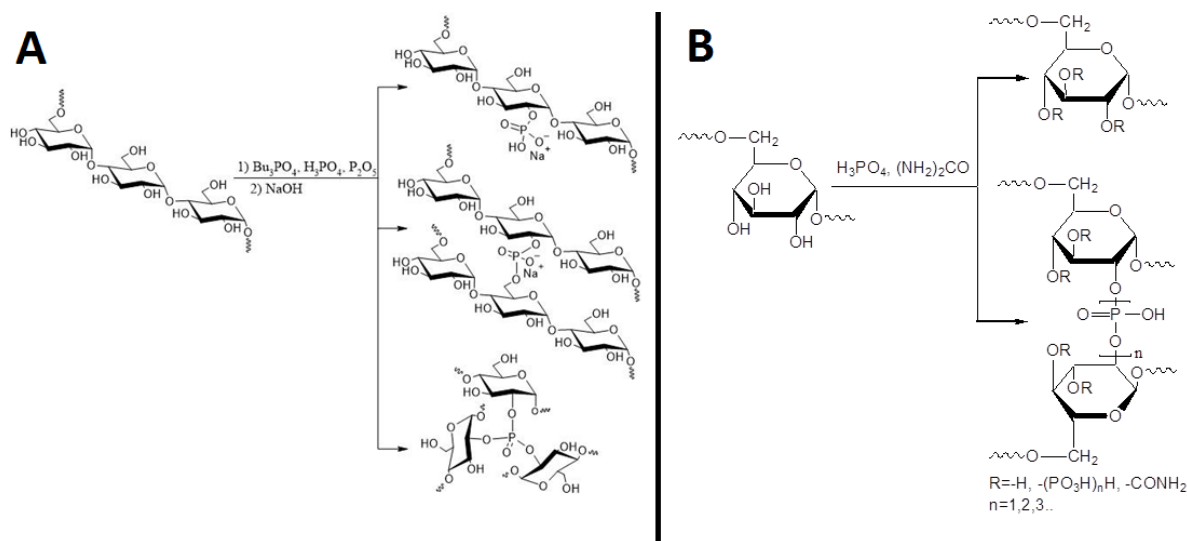

**Scheme 1.** Scheme of the synthesis of pullulan phosphate (A) and dextran phosphate (B).

The results of this work are the first step for further study of the physicochemical properties and the potential use of the obtained samples as a basis for the creation of antitumor drugs.

#### Acknowledgements

This work was financially supported by the State Program of Scientific Research of the Republic of Belarus (2021–2025 years, program "Chemical processes, reagents and technologies, bioregulators and bioorganic chemistry", grant # 2.2.02.07).

STUDYING THE MECHANISM OF OXIDATIVE CONVERSION REACTIONS OF C<sub>1</sub>–C<sub>2</sub> PARAFFIN HYDROCARBONS*Fikret Aliyev*

Institute of Catalysis and Inorganic Chemistry named after acad. M. Nagiyev of Ministry of Science and Education of Republic of Azerbaijan, Baku

[iradam@rambler.ru](mailto:iradam@rambler.ru)

The kinetic model occupies a central place in the mathematical model of the process, which acts as the basis for its optimal design. For the successful solution of this problem, it is most appropriate to use theoretically based kinetic models based on the probable stepwise mechanism of the reaction. Such kinetic models retain their accuracy when extrapolating kinetic data to experimentally unexplored regions.

As can be seen from the results, all Mn-Li-Ni-clinoptilolite compositions show relatively high activity and selectivity in the considered reaction. Clinoptilolite containing 8 wt.% Mn<sup>2+</sup>, 7 wt.% Li<sup>+</sup> and 8 wt.% Ni<sup>2+</sup> with a silicate modulus  $\lambda=10.8$  is the most active for the considered reaction in all studied regimes [1].

In order to determine the mechanism of formation of reaction products and to design the kinetic scheme of the process, we conducted a series of experiments in single-stage quartz reactors with free volume after the catalyst bed:  $V_1=25\text{ cm}^3$ ,  $V_2=45\text{ cm}^3$  and  $V_3=55\text{ cm}^3$ , at temperature  $T=800^\circ\text{C}$ , catalyst volume  $V_{\text{cat}}=0.5\text{ cm}^3$  and reagent feed rate  $=0.312\text{ mol/h}$ ,  $=0.2\text{ mol/s}$ .

It was determined that with the increase of the free volume of the reactor after the catalyst bed, the productivity of ethylene increases, while that of ethane decreases. At the same time, the conversion rate of methane and the efficiency of carbon dioxide practically do not change. This indicates that the oxidative dimerization reaction of methane to ethane proceeds at a relatively high rate on the catalyst surface, while the usual dehydrogenation of ethane to ethylene occurs in the free volume. The stability of the conversion and release of carbon dioxide in different free volumes after the catalyst bed, as well as the absence of oxygen in the reaction products after the catalyst, indicate that the carbon dioxide formation reaction proceeds with methane oxidation on the catalyst surface. Acetylene and 1,4-butanediol were not present in the reaction products in single-stage reactors. Therefore, they are formed on the surface of the catalyst in the second stage of the reactor.

Based on the above, the kinetic scheme of the catalytic oxidative conversion of methane to 1,4-butanediol can be presented as follows.

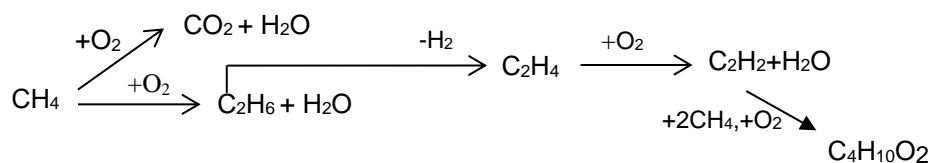

The proposed kinetic scheme for the formation of ethane, ethylene, carbon dioxide, acetylene and butanediol corresponds to the following general stoichiometric equations:

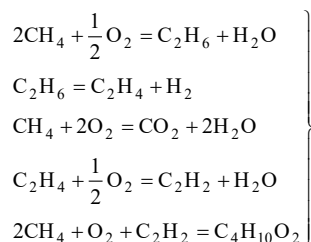

According to the general stoichiometric equations above, the reaction takes place on five independent general routes. We provide a description of each route and its flow rate. As a result, by integrating the rate equations of each route into the system with respect to common variables, we obtain a fully theoretically justified kinetic model of the of the process under consideration.

According to the step-by-step mechanism, the reaction of the oxidative conversion of methane to ethane occurs as a result of the interaction of dissociatively adsorbed oxygen molecules with methane molecules, resulting in the formation of the oxygen-hydrocarbon surface complex  $\text{ZOCH}_3$ , which leads to the formation of ethane in interaction with methane molecules.

**References**

[1] Локтев А.С. Автореферат дисс...докт.хим.наук. 2004. 54

## TERT-BUTYLNITRITE IN THE SYNTHESIS OF FUNCTIONALIZED ISOXAZOLE DERIVATIVES

Astakhova N.E.<sup>1</sup>, Vasilenko D.A.<sup>1</sup>, Averina E.B.<sup>1</sup><sup>1</sup> Moscow State University, Moscow, Russia

PhD Student

[nadezhda.astakhova@chemistry.msu.ru](mailto:nadezhda.astakhova@chemistry.msu.ru)

Recently a preparative approach to 3-aryl-4-nitroisoxasoles has been elaborated in our laboratory. This process is based on the heterocyclization reaction of aryl substituted vinylketones **I** with *t*-BuONO in a mixture of dioxane and water [1]. In this work 5-methyl-4-nitroisoxazoles **II** were used for the functionalization of position 5 of the isoxazole moiety. For this purpose 5-methylisoxazoles **II** were involved in the condensation reaction with dimethylacetal N,N-dimethylformamide to obtain a series of 4-nitro-5-enamines **III**. It is known that enamines **III** are characterized by a variety of synthetic applications because they can react with electrophilic and radical agents [2]. We found that the reaction of enamines **III** with *t*-BuONO in the presence of  $\text{BF}_3 \cdot \text{Et}_2\text{O}$  proceeds with the formation of previously unknown 4-nitroisoxazol-5-carbonitriles **IV**. Using this general synthetic approach a large scope of substances **IV** was obtained in moderate to high yields.

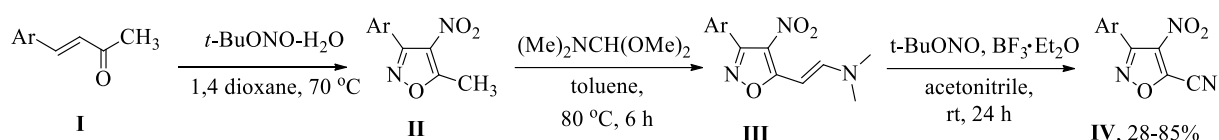
Ar = Ph-, 3-MeOC<sub>6</sub>H<sub>4</sub>-, 3,4,5-MeOC<sub>6</sub>H<sub>2</sub>-, 3-MeSC<sub>6</sub>H<sub>4</sub>-, 3-ClC<sub>6</sub>H<sub>4</sub>-,3-F<sub>3</sub>CC<sub>6</sub>H<sub>4</sub>-, 3-O<sub>2</sub>NC<sub>6</sub>H<sub>4</sub>-, furanyl-, thiophenyl-, biphenyl-, naphthyl-**Scheme 1.** Synthetic approach to 4-nitroisoxazol-5-carbonitriles **IV**.

4-Nitroisoxazol-5-carbonitriles **IV**, as a new structural type of soxazole derivatives, are of interest to study their synthetic utilities. For carbonitriles **IV** two novel paths for modification were found with 4-nitroisoxazol-5-carbonitrile **IVa** as an example. The reduction of the nitro group at position 4 of isoxazole ring leads to 4-aminoisoxazol-5-carbonitrile **Va** in a good yield (60%), while  $\text{S}_{\text{N}}\text{Ar}$  reactions of cyano group at position 5 with N- and S-nucleophiles provide a range of isoxazole derivatives **VI** in 30-94% yields.

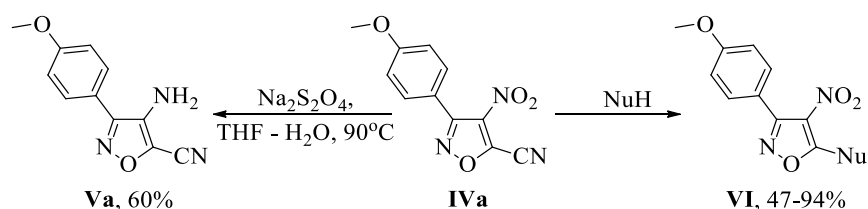
NuH = R<sub>1</sub>-NH<sub>2</sub>, R<sub>2</sub>-NH-R<sub>3</sub>, R<sub>4</sub>-SH**Scheme 2.** Transformations of 4-nitroisoxazol-5-carbonitrile **IVa**.

## References

- [1] *Synthesis* **2020**, 52, 1398  
 [2] *Tetrahedron Lett.* **2015**, 56, 7168

SYNERGISTIC EFFECT IN THE CATALYTIC REACTION AEROBIC OXIDATION  
OF ISOPROPYLBENZENE

Zeynalov E.B., Huseynov E.R., Sharifova S.K., Abdullaeva F.A., Behbudova S.K

Institute of Catalysis and Inorganic Chemistry named after Academician M.Nagiyev, Baku, Azerbaijan  
Behbudova S.K- researcher  
[chem@kqki.science.az](mailto:chem@kqki.science.az)

One of the interesting applications of amino acid salts is their potent ability to catalyze oxidation processes of organic substances. In this sense, manganese salts of amino acids are of particular interest for catalyzing reactions of complex hydrocarbon mixtures.

The use of manganese salts of organic acids has shown that they are also effective for the processes of interphase aerobic oxidation of hydrocarbons [1-2]. In the present work, the synthesized complex of manganese salt of aminoacetic acid  $[\text{NH}_2\text{CH}_2\text{COO}]_2\text{Mn}\cdot 2\text{H}_2\text{O}$  was used as an active additive to iron-containing multi-walled carbon nanotubes (Fe@MUNT) in the model reaction of aerobic oxidation of isopropyl benzene. It was found that the compounds  $[\text{NH}_2\text{CH}_2\text{COO}]_2\text{Mn}\cdot 2\text{H}_2\text{O}$  and (Fe@MUNT), taken separately as catalysts, have catalytic activity and accelerate the reaction by 10-12 times compared to a sample of non-catalytic reaction of isopropylbenzene, not containing additives. When their equimolecular quantities are used together, even greater acceleration of the process is observed, i.e. the reaction rate of isopropylbenzene oxidation increases significantly in comparison with the control sample.

The figure shows the kinetic curves of oxygen uptake during aerobic oxidation of isopropylbenzene at 100°C in the presence of  $[\text{NH}_2\text{CH}_2\text{COO}]_2\text{Mn}\cdot 2\text{H}_2\text{O}$  and Fe@MUNT iron-containing carbon nanotubes. From the kinetics of oxygen uptake, it can be seen that the Mn complex has significant catalytic activity and accelerates the reaction by a factor of 10 [Fig.1(2)] compared to the isopropylbenzene sample containing no additives [Fig.1(1)]. When the complex  $[\text{NH}_2\text{CH}_2\text{COO}]_2\text{Mn}\cdot 2\text{H}_2\text{O}$  and iron-containing multi-walled carbon nanotubes (Fe@MUNT) are used together, an even greater acceleration of the process is observed, i.e. the oxidation reaction rate increases strongly and reaches 373  $\text{mm}^3\text{O}_2/\text{min}$  [Fig.1(3)]. Consequently, at a total catalyst dosage of 2g/l and a temperature of 100°C the reaction rate of isopropylbenzene oxidation increases 75 times compared to the control sample.

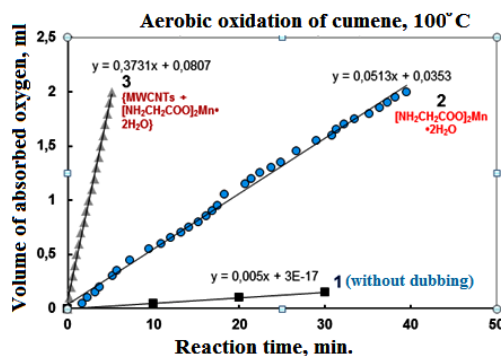

**Figure 1.** Kinetic curves of oxygen uptake during aerobic oxidation of isopropylbenzene in the absence (1) and presence of glycine salt  $[\text{NH}_2\text{CH}_2\text{COO}]_2\text{Mn}\cdot 2\text{H}_2\text{O}$  (2) and a mixture of glycine salt with iron-containing MWCNTs  $[\text{NH}_2\text{CH}_2\text{COO}]_2\text{Mn}\cdot 2\text{H}_2\text{O} + \text{Fe@MUNT}$ s (3). The volume of the reaction mixture is 10  $\text{cm}^3$ , temperature 100°C. Amount of additives:

1. 0; 2.  $[\text{NH}_2\text{CH}_2\text{COO}]_2\text{Mn}\cdot 2\text{H}_2\text{O} = 2\text{g/L}$ ;
3.  $[\text{NH}_2\text{CH}_2\text{COO}]_2\text{Mn}\cdot 2\text{H}_2\text{O} = 1\text{g/l} + \text{Fe@MNT} = 1\text{g/l}$

The obtained results indicate the manifestation of a strong synergistic effect and the prospects of using synergistic mixtures of complexes of amino acids with metal-containing carbon nanotubes as effective catalysts for redox processes in chain reactions of aerobic liquid-phase oxidation of hydrocarbons. Thus, it can be concluded that the use of such catalytic systems has an interesting prospect for further studies in the field of catalysis.

### References

- [1] *Chemistry & Chemical Technology* **2021**, 15(4), 479-485
- [2] *Uspekhi v khimii i khimicheskoy tekhnologii* **2008**, V. XXII, 9(89), 87-91



## PECULIARITIES OF TETRAETHOXYSILANE GELATION IN ASSOCIATED MEDIA OF DIOLS

A.M. Bondareva

MIREA - Russian Technological University, Moscow, Russia

Postgraduate

[bondaalevtina@yandex.ru](mailto:bondaalevtina@yandex.ru)

In the present work the peculiarities of  $\text{Si}(\text{OEt})_4$  (TEOS) gel formation in associated media of diols (AC) have been studied by DLS methods. The gels were obtained using both one-step and two-step sol-gel process. The following diols were used as diols: terminal diols  $\text{OH}(\text{C}_n\text{H}_{2n})\text{OH}$ , oxyethylated diols  $\text{OH}(\text{CH}_2\text{CH}_2\text{O})_n\text{OH}$  and their esters  $\text{OH}(\text{CH}_2\text{CH}_2\text{O})_n\text{OR}$ , as well as mixtures of ACs in different ratios. The maximum size of aggregates bound by hydrogen bonds is observed for the terminal diols. For them not only the contribution of the slow mode to DLS is maximal, but also the diffusion coefficients in comparison with oxyethylated diols or their esters. In this case, the formed gel can be easily visualized as a three-dimensional network filled with solvent with a small amount of dispersed phase (1-3%) and possess a certain degree of rigidity and elasticity, which allows to obtain transparent form-stable gels.

For the one-step process, the alkaline catalyst diethanolamine (DEA) in the system  $\text{AC-Si}(\text{OEt})_4 - \text{H}_2\text{O}$  (95:3:2) at  $\text{pH} = 8.5 - 9.1$  was used. In the two-step process, the first step of TEOS used the acid catalyst citric acid in a similar system (95:3:2) at  $\text{pH} = 1.7 - 2.5$  and the second step used DEA.

The DLS spectra of pure diols and mixtures with  $\text{Si}(\text{OEt})_4$  confirm the formation of associated aggregate structures in solution. The study of gelation kinetics during 1- 50 days by DLS method in general case showed the existence of two types of agglomerates in solutions - from associated diols  $\langle r \rangle \sim 10 - 50 \mu\text{m}$  and aggregates of siloxane links in the range of 60 - 400 nm. As the gelation process proceeds, the incorporation of the siloxane mesh into the diol mesh is observed, which leads to their destruction with the formation of a single uniform structure. In the alkaline process, two types of agglomerates are first manifested and with increasing time ( $\Delta\tau$ ) from 3 to 9 days, an increase in the siloxane mesh of 100 nm to 400 nm is observed with a simultaneous decrease in the contribution of AC agglomerates from 77.4% to 13%. With further increase of  $\Delta\tau$ , a structure with almost monomodal distribution of aggregates  $\langle r \rangle = 1100 \text{ nm}$  is observed. When the gelation time was further increased to 32 days, the size of aggregates decreased and there is simultaneous depolymerization with an increase in the fast mode fraction and compression of the siloxane mesh to  $\langle r \rangle = 140 - 110 \text{ nm}$ . The system again proceeds to the separation of AC aggregates and Si-O-Si mesh.

The obtained result can be explained by the participation of diol molecules in the creation of the mesh during the AC esterification of silanol hydrolysis products and its transition to the siloxane mesh, i.e. partial internal syneresis.

When the two-step process is carried out, marked differences from the one-step process are observed. In the first stage in acidic medium at  $\text{pH} = 1.7 - 2.5$ , similar processes are observed, but there is a more noticeable effect on the structure of the aggregates in solution. A monomodal distribution of solution aggregates is observed at high  $\Delta\tau$ , and  $\langle r \rangle = 410 - 480 \text{ nm}$ , which confirms the formation of shorter Si-O-Si bond chains compared to alkaline gelation. However, when  $\Delta\tau$  is further increased up to 53 days, there is a marked increase in the size of the aggregates. In the second step, hydrolysis is completed by the absence of water. Condensation of the oligomeric and monomeric forms of alkoxy silanols resulting from the first step results in the formation of a condensed gel. Subsequent introduction of DEA into the system up to  $\text{pH} \sim 9$  initially leads to separation of the aggregates and subsequent monomodal distribution of smaller size aggregates compared to the one-step process up to  $\langle r \rangle = 60 - 75 \text{ nm}$ .

**Acknowledgements**

I would like to express my gratitude to Stanislav Sergeevich Kudzh, Rector of MIREA-Russian Technological University.



## HYDROGENATION OF ARYLACROLEINS AS A METHOD FOR OBTAINING NEW CORROSION INHIBITORS

*Borisova Yu.G.<sup>1</sup>, Musin A.I.<sup>1</sup>, Dzhumaev Sh.Sh.<sup>1</sup>, Raskildina G.Z.<sup>1</sup>*

<sup>1</sup> Ufa State Petroleum Technological University, Ufa, Russia;  
[yulianna\\_borisova@mail.ru](mailto:yulianna_borisova@mail.ru)

Substituted linear and cyclic acetals are widely used in petrochemical processes and exhibit anti-corrosion, biocidal, oxygenate and anti-knock properties [1-2].

As part of the continued search for new corrosion inhibitors, we proposed the hydrogenation of  $\alpha$ -phenylacrolein derivatives in the presence of a NiMo catalyst (nickel and molybdenum oxides supported on zeolite) in order to synthesize saturated acetals - promising substances with various anti-corrosion activities.

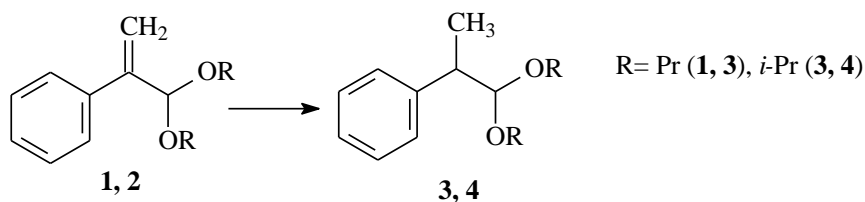

**Scheme 1.** Hydrogenation esters.

Hydrogenation of olefins 1, 2 was carried out at a temperature of 200°C, olefin:hydrogen molar ratio = 1:6 and reaction duration 30 min. In this case, the yield of acetals 3 and 4 reached 95%.

Compounds 3 and 4, synthesized using a well-known method [3], were studied as reagents capable of exhibiting anti-corrosion properties in an acidic environment. The maximum protective effect was achieved in the case of using compound 4 (75%), and the minimum effectiveness against acid corrosion was shown by substance 3 (52%). Probably, the obtained result is associated with different degrees of adsorption of the synthesized structures on the metal surface. The results obtained indicate that the substances under study have a protective ability and are promising additives to corrosion inhibitors.

### References

- [1] *Proceedings of Universities. Applied Chemistry and Biotechnology* **2018**, 8(1), 19-34  
 [2] *Rev. and Adv. in Chem* **2023**, 13, 15-27  
 [3] *Bashkir chemical journal* **2017**, 24, 1, 15-17

### Acknowledgements

«The work was carried out within the framework of the state assignment of the Russian Ministry of Education and Science in the field of scientific activity, publication number FEUR - 2022-0007 "Petrochemical reagents, oils and materials for thermal power engineering».

## CATALYST-FREE PHOTOCHEMICAL C-H BOND FLUORINATION OF AROMATIC CARBONYL COMPOUNDS

Chernovskii N.D.<sup>1,2</sup>, Zaikin P.A.<sup>2</sup><sup>1</sup> Novosibirsk State University, Novosibirsk, Russia<sup>2</sup> Novosibirsk Institute of Organic Chemistry SB RAS, Novosibirsk, Russia

Student

[n.chernovskii@g.nsu.ru](mailto:n.chernovskii@g.nsu.ru)

Organic fluorides are widely represented on the pharmaceutical and agrochemical markets [1-2]. By the way, several conventional approaches couldn't be applied for introduction of fluorine moiety in small organic molecules. Since then, fluorination is a synthetic problem of great importance. Direct C-H bond fluorination allows to introduce fluorine in small molecules in step-economic manner. Recently, many catalytic approaches for C-H fluorination have been developed [3].

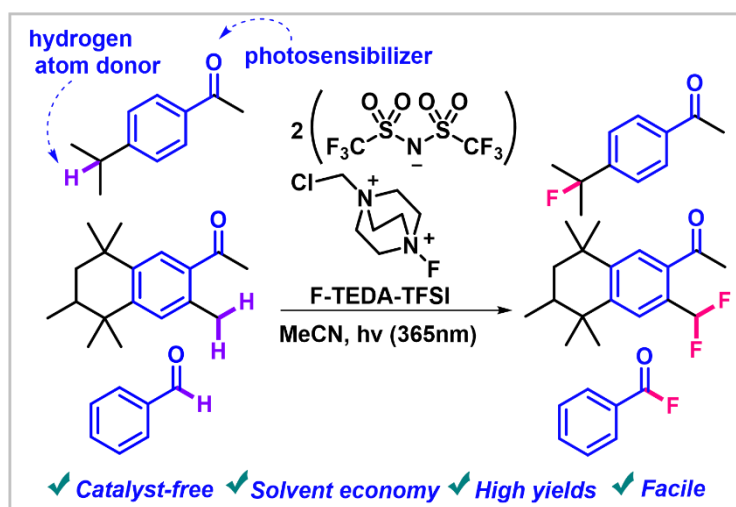

Scheme 1. Graphical abstract.

We have developed an approach for selective photochemical C-H bond fluorination without the addition of catalysts and additives, shorter times and lower solvent loadings. The substrates of the reaction are alkylaromatic ketones and aromatic aldehydes, compounds containing a photoactive Ar-C(O)-fragment. For aromatic ketones it turned out, that we can obtain both monofluorination and difluorination products by varying stoichiometry of reagents. Reaction of aldehydes typically takes 15 minutes with almost quantitative yields.

## References

- [1] *ACS omega*, **2020**, *5*, 10633  
 [2] *J. Fluor. Chem.* **2014**, *167*, 16  
 [3] *Angew. Chem., Int. Ed.* **2019**, *58*, 14824

## OBTAINING OF 12-ARYLDIAZOBERRUBINE: EXPERIMENTAL AND THEORETICAL RESEARCH

*Dryapak A.N.<sup>1</sup>, Zagrebaev A.D.<sup>2</sup>, Alyoshukina A.B.<sup>3</sup>*

<sup>1</sup> Southern Federal University, Rostov-on-Don, Russia

<sup>2</sup> International Research Institute of Intelligent Materials of the Southern Federal University, Rostov-on-Don, Russia

<sup>3</sup> Rostov Scientific Research Institute of Microbiology and Parasitology, Rostov-on-Don, Russia  
1<sup>st</sup> year PhD student  
[adryapak@mail.ru](mailto:adryapak@mail.ru)

Berberine **1** is a natural isoquinoline alkaloid of the protoberberine series, found in various parts of many plants, including the root of barberry [1]. It is a biologically active molecule with such activities as anticancer, antitumor and antibacterial [2].

There are several ways to modify berberine, one of which is to obtain 9-substituted – berberrubine **2**, which also has a number of biological properties. The appearance of a hydroxyl group in this ring makes it possible to modify this compound at position 12 [3].

The purpose of this work is a theoretical and experimental study of the synthesis of berberine derivatives with an arylase group at the C-12 position of the berberine backbone.

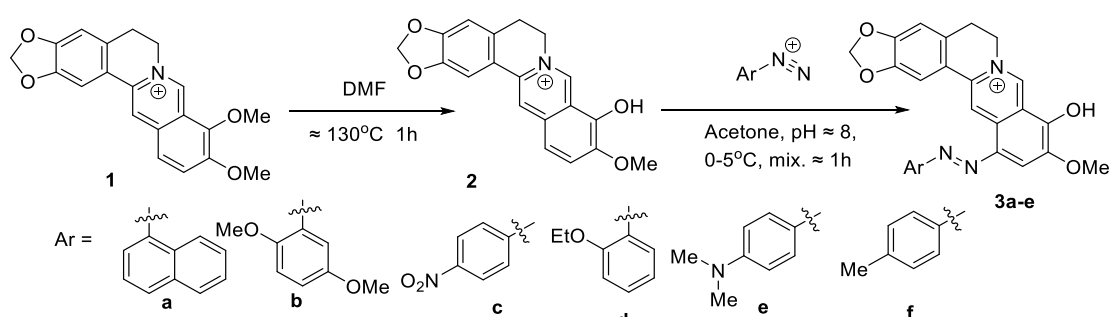

**Scheme 1.** Modification of the berberine skeleton according to the position of C-12.

During the research, it was found out that the obtained compounds have extremely low solubility, therefore, it was further decided to introduce these structures into the 9-position acylation reaction to increase the solubility of the obtained 12-derivatives of 3a-f.

The result of this work was the development of a new method for modifying berberine using diazonium salts as electrophiles by activating the berberine backbone (formation of berberrubine) with further confirmation of structures (NMR spectroscopy and HRMS method).

Modification of 12-derivatives of berberine at the C-9 position was carried out, which made it possible to increase the solubility of the obtained derivatives, a structure-property analysis for the obtained compounds was carried out, which showed that derivatives containing donor substituents in the para position of the phenyldiazo group turned out to be the most biologically active.

### References

- [1] *Chemistry for sustainable development* **2010**, 18, 1-23  
 [2] *Aaps Pharmscitech* **2011**, 12, 705-711  
 [3] *Chem. Heterocycl. Compd.* **2023**, 59(8), 604-609

### Acknowledgements

NMR spectra were recorded on a Bruker DPX-250 (250 MHz for <sup>1</sup>H, 62.9 MHz for <sup>13</sup>C) spectrometer at the Scientific and Educational Laboratory of Resonance Spectroscopy, Department of Natural and High Molecular Compounds Chemistry of Southern Federal University.

## BIFUNCTIONAL CATALYSTS FOR PROPYLENE CARBONATE OBTAINING FROM UREA AND PROPYLENE GLYCOL

*Elpashev A.S.<sup>1</sup>, Lysikova A.S.<sup>1</sup>, Samuilov A.Ya.<sup>1</sup>, Samuilov Ya.D.<sup>1</sup>*

<sup>1</sup> Kazan National Research Technological University, Kazan, Russia

Graduate student

[elpashev1999@mail.ru](mailto:elpashev1999@mail.ru)

Cyclic carbonates have wide application field as solvents in different chemical transformations due to low toxicity and biodegradability. They are used as electrolytes in lithium-ion batteries. Polyethylene- and polypropylene carbonates are raw materials for biodegradable packaging materials. Ethylene carbonate and its homologues are used for producing other dialkylcarbonates or glycerol carbonate.

One of the safest ways to obtain cyclic carbonates is interaction of urea and alkylene glycols. Urea and glycols are safe, non-toxic and available compounds.

Known, that Lewis acids have good catalytic effect to this reaction. Since 1991 many catalysts were studied, for example zinc salts, tin-containing catalysts (T-12), magnesium, calcium, lanthanum, lead compounds<sup>3,4</sup>.

The series of experiments showed, that known catalysts are not so effective. Therefore, new zinc-containing catalyst, precisely complex Zn with L-proline, was synthesized.

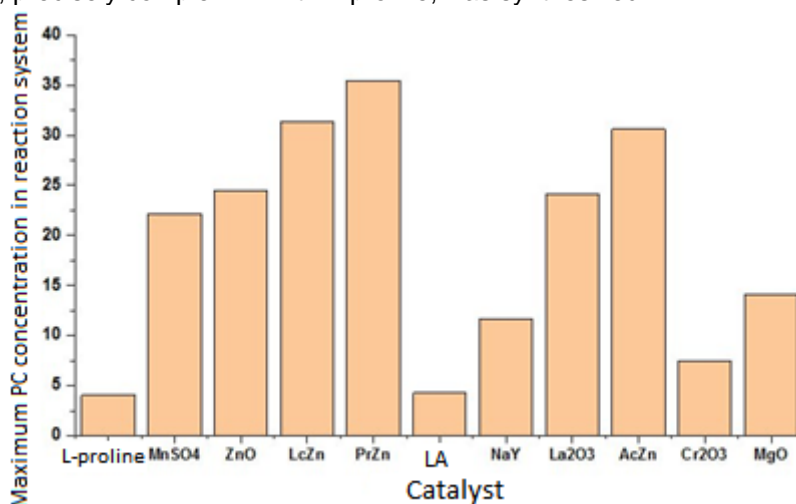

**Scheme 1.** Catalytic activity of different catalysts in propylene carbonate synthesis; LA – lactic acid, LcZn – zinc complex with lactic acid, PrZn – zinc complex with L-proline

The yield of propylene carbonate reached 55% under the following conditions: temperature is 150 °C, pressure is 20 mm Hg., molar ratio of urea:glycol = 1:1,3, amount of catalyst is 0,006 mole, reaction time is 4 h.

### References

- [1] *Chem. Eng. Data* **2006**, 51(2), 416-418
- [2] *Electrochemical Energy* **2016**, 16(4), 155-195
- [3] *Ind. Eng. Chem. Res.* **2004**, 43, 4038-4042
- [4] *Catal. Today* **2006**, 115, 111-116

STRUCTURAL CHANGES IN CYANOCOBALAMIN IN THE PRESENCE OF THE HClO/Fe<sup>2+</sup> SYSTEM*Erina A.A.<sup>1</sup>, Borodulin V.B.<sup>1</sup>, Ishchenko A.A.<sup>1</sup>*

<sup>1</sup> M.V. Lomonosov Institute of Fine Chemical Technologies, MIREA - Russian Technological University, Moscow, Russia  
PhD student  
[aaerina@mail.ru](mailto:aaerina@mail.ru)

Vitamin B<sub>12</sub> is a key molecule in the synthesis of hemoglobin and the maturation of red blood cells. A lack of vitamin B<sub>12</sub> can lead to the development of anemia. The hydroxyl radical is a highly reactive particle that is formed not only during the Fenton reaction during the interaction of H<sub>2</sub>O<sub>2</sub> with Fe<sup>2+</sup>, but also in the HClO/Fe<sup>2+</sup> system. Hypochlorite can form a hydroxyl radical when reacting with iron ions, and the formation occurs more intensely than in the Fenton reaction [1,2]. HClO is part of the immune system, produced in response to inflammatory processes.

In this work, we studied a model of oxidative stress - the interaction of cyanocobalamin (CNCbl) with hydroxyl radical generated in the HClO/Fe<sup>2+</sup> system. The order and rate of the reaction were determined graphically by the Van't Hoff method - pseudo-first order reaction ( $k = 1.13 \text{ s}^{-1}$ ).

Adding to a solution of cyanocobalamin at a concentration of 44 μM iron(II) sulfate at concentrations of 2, 4 and 6 mM and HOCl at a concentration of 298 μM (obtained by adding 1 ml of acetic acid (19.7 mM) to 1 ml of sodium hypochlorite (52.2 mM)) leads to a significant decrease in signals at characteristic wavelengths of 281, 361 and 551 nm. An increase in Fe<sup>2+</sup> concentration leads to a decrease in the intensity of the main signals in the absorption spectra of the vitamin. A clear bathochromic shift is observed in the wavelength range 281–305 nm depending on the iron concentration, which may indicate a change in the structure of the 5,6-dimethylbenzimidazole fragment.

Using high-performance liquid chromatography, one of the peaks was detected as a decomposition product of cyanocobalamin, the elution time range of which from the chromatographic column was 0.743-0.809 min. The fragmentation of the resulting product is presented in Scheme 1. One can notice the absence of the main signal at  $m/z$  678.29 and  $m/z$  1355.57, related to the cyanocobalamin solution.

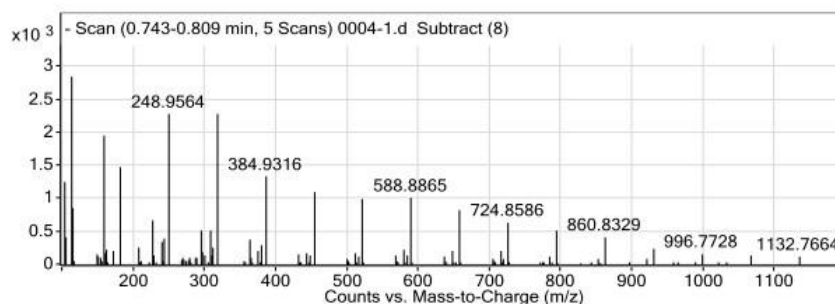

**Scheme 1.** Mass spectrum of the product found in the reaction mixture (retention time 0.743-0.809 min).

## References

- [1] *Soros Educational Journal* **2000**, 6(12), 13-19  
[2] *Biophysics* **1994**, 39(2), 275

## PHOTOCHEMICAL METHOD DEVELOPMENT FOR THE SYNTHESIS OF FIVE-MEMBERED METALLACYCLOCUMULENES AND STUDY OF THEIR REACTIVITY

Frolov M.A.<sup>1</sup>, Andreev M.V.<sup>1</sup>, Akishkina I.A.<sup>1</sup>, Burlakov V.V.<sup>1</sup><sup>1</sup> A.N. Nesmeyanov Institute of Organoelement Compounds, Moscow, Russia  
PhD Student[frolovmikhail38@gmail.com](mailto:frolovmikhail38@gmail.com)

At present, a fairly large number of five-membered metallocyclocumulene complexes with various Cp-ligands and substituents in the metallacycle have been obtained. Moreover, most methods for the preparation of such compounds are based on the interaction of active forms of metallocenes with diacetylenes. However, the use of terminal acetylenes instead of diacetylenes may increase the synthetic availability of these complexes. We have developed a simple method for the synthesis of five-membered metallocyclocumulenes  $\text{Cp}_2\text{M}(\eta^4\text{-RC}_4\text{R})$  ( $\text{M} = \text{Ti}, \text{Zr}, \text{Hf}$ ) starting from  $\text{Cp}_2\text{MCl}_2$  and terminal acetylenes by UV-irradiation of metallocene diacetylides (Scheme 1).

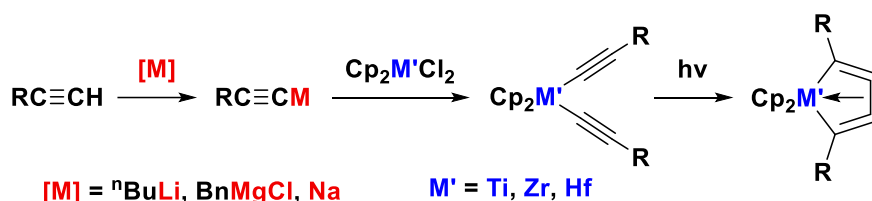

**Scheme 1.** Preparation of metallocyclocumulenes from terminal acetylenes and  $\text{Cp}_2\text{MCl}_2$ .

We investigated some of the chemical properties of obtained metallocyclocumulenes (Scheme 2), for example, protonolysis reaction [1-2]. The insertion reactions of various ketones and nitriles into the M-C bond upon heating or UV irradiation have also been studied. In the case of ketones, unsymmetrical nine-membered dioxazirconacyclocumulenes were obtained. The difference in the direction of these reactions for the presented methods of influence in our work is shown. In the case of ketones, unsymmetrical nine-membered dioxazirconacyclocumulenes were obtained.

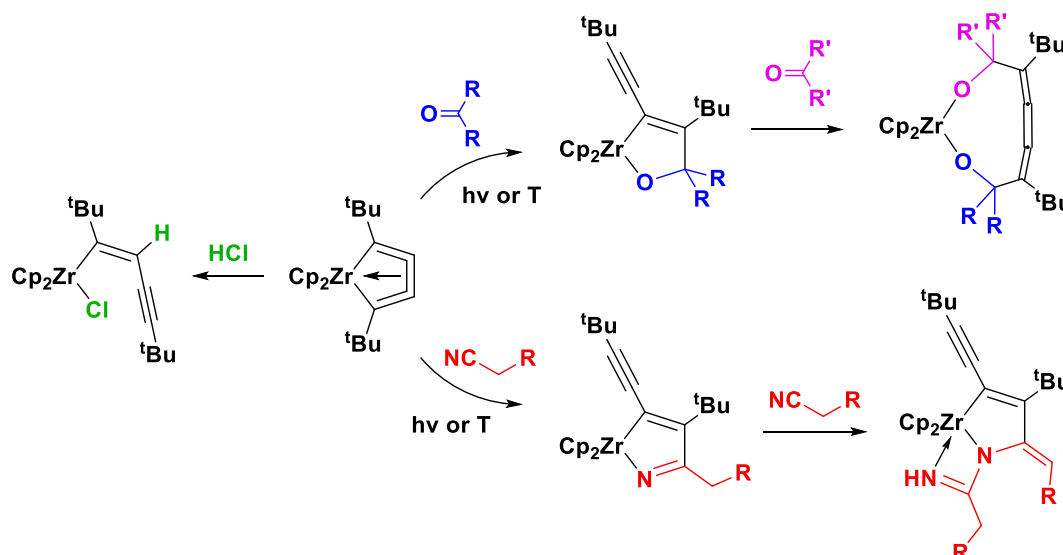

**Scheme 2.** Reactions of metallocyclocumulenes with acids, ketones and nitriles using the example of  $\text{Cp}_2\text{Zr}(\eta^4\text{-tBuC}_4\text{tBu})$ .

## References

- [1] *Mendeleev Commun.* **2023**, 33, 6, 750  
 [2] *Mendeleev Commun.* **2024**, 34, 2, 188

## Acknowledgements

This work was supported by the Russian Science Foundation (project No 22-73-00326).



## CHALLENGING CROSS-COUPLING REACTIONS BETWEEN SENSITIVE PYRIDINE DERIVATIVES

Gak A.S., Yan Liu, Yong Cui

School of Chemistry and Chemical Engineering, Shanghai Jiao Tong University, Shanghai, China

PhD Candidate

[alexandrg03@gmail.com](mailto:alexandrg03@gmail.com)

It is a known fact that pyridine derivatives are important components of many drugs, catalysts, biologically active compounds, etc. With the avalanche-like development of these fields over last years, acutely increasing necessity for more effective methods the formation of C-C bonds between pyridine derivatives. Unfortunately, pyridine derivatives have a low reactivity and their combination is difficult. Cross-coupling reactions of pyridine derivatives with sensitive groups is a challenge.

Currently, the Suzuki-Miyaura reaction using pyridine-boronic acids and esters is considered the most effective method for the cross-coupling of pyridine derivatives and often used based on published papers over the past decades. The big disadvantage of this method is the multi-stage nature, the difficulty in obtaining of boronic pyridine derivatives (Scheme 1) and the need to use strong base salts, which is harmful to sensitive substrates (Scheme 2). In this work, we report new approaches to solve existing difficulties in the cross-coupling of sensitive pyridine derivatives based methyl 6-bromonicotinate, methyl 6-iodonicotinate and 5-bromo-2-iodopyridine.

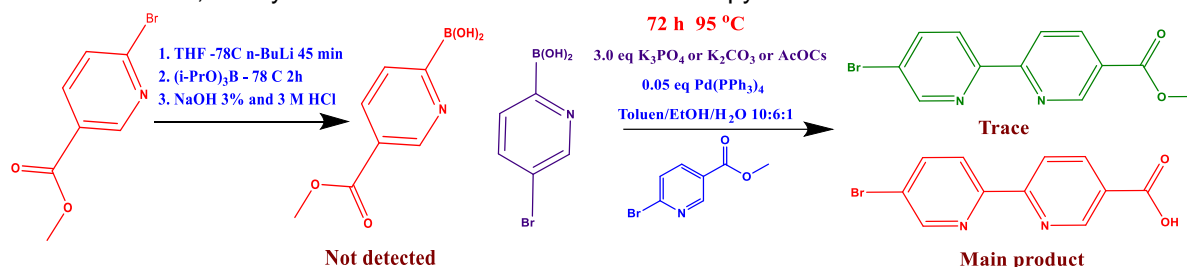

**Scheme 1.** Synthesis of sensitive Py-B(OH)<sub>2</sub> **Scheme 2.** Cross-coupling reaction with strong salt base

One way to solve the problem can be to use softer base salts such as a mixture of sodium and potassium acetate but with a significant increase in the time required for the reaction complete (Scheme 3). Another solution to use one spot reaction using Grignard reagent (Scheme 4) or tin-organic compounds (Scheme 5). Since to more kindly reaction conditions, unreacted initial components do not degrade and can be easily isolated and reused again.

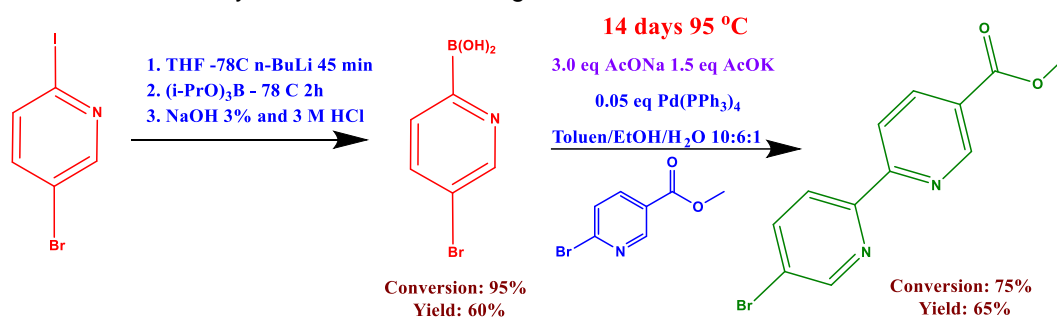

**Scheme 3.** Suzuki-Miyaura cross-coupling reaction of pyridine sensitive derivatives

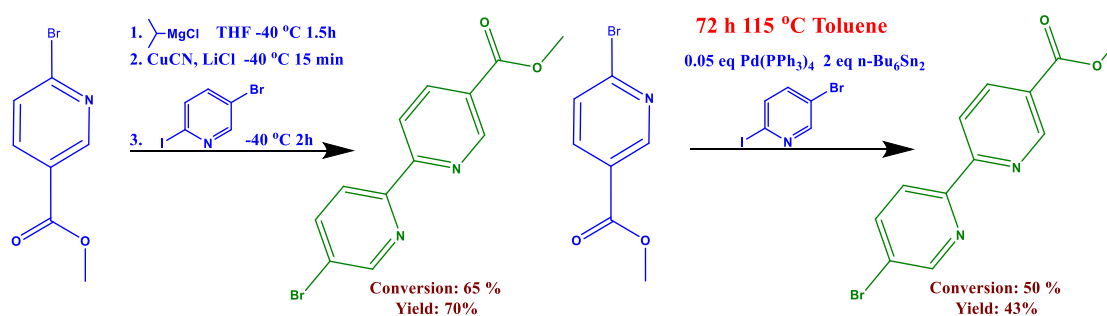

**Scheme 4.** Application of the Grignard reagent **Scheme 5.** Application of the tin-organic compounds

## AMIDOALKYLATION OF PHOSPHONOUS ISOSTERE OF ASPARTIC ACID

*Ivanov D.E.*<sup>1</sup>, *Borodachev A.V.*<sup>1</sup>, *Golovash S.R.*<sup>1</sup>, *Dmitriev M.E.*<sup>1</sup>, *Ragulin V.V.*<sup>1</sup>

<sup>1</sup> Institute of Physiologically Active Compounds at Federal Research Center of Problems of Chemical Physics and Medicinal Chemistry, Russian Academy of Sciences, Chernogolovka, 142432, Russia

Master's degree, postgraduate

[cratos97@yandex.ru](mailto:cratos97@yandex.ru)

Studies of the carbamate version of the Kabachnik-Fields reaction in recent years indicate its growing preference over the amide and classical versions of this method for construction of the  $\alpha$ -aminophosphorylic function [1-3]. Interesting targets for amidoalkylation are phosphonous carboxylic acids containing a structural isostere of a natural amino acid. This approach leads to phosphinic peptides, inhibitors of metalloproteinases, structural isosteres of natural peptides, in the molecule of which the peptide NC(O) bond is replaced by methylene phosphorylic moiety CH<sub>2</sub>P(O)OH [4].

In this work, the phosphonous isostere of aspartic acid, containing protected amino group, phosphonous 2-acetamidopropionic acid **1**, was taken as the hydrophosphorylic component of the reaction under study.

Amidoalkylation of phosphonous acid **1** with alkyl carbamates **2** and aldehydes **3** or their interaction products, dialkyl alkylidene biscarbamates **4**, gives functionally substituted phosphinic acids **5** in accordance with the carbamate version of the Kabachnik-Fields reaction (Scheme 1).

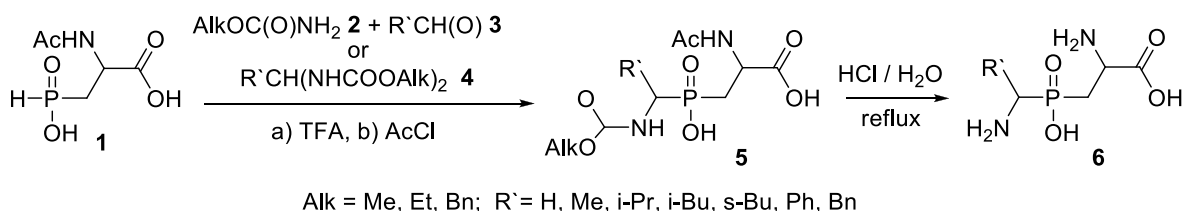

**Scheme 1.** Amidoalkylation of phosphonous isostere of aspartic acid **1**.

Hydrolysis of acids **5** followed by treatment with propylene oxide in aqueous alcohol leads to the formation of unusual  $\alpha$ -aminophosphinic  $\alpha$ -aminocarboxylic acids **6** in free form. These compounds can be considered as phosphinic structural isosteres of peptides, in which the N-component is 2,3-diaminopropionic acid, involved in a number of important enzymatic processes [5].

## References

- [1] *J. Org. Chem.* **2021**, *86*, 593-600
- [2] *Org. Lett.* **2021**, *23*, 1726-1730
- [3] *Mendeleev Commun.* **2023**, *33*, 784-785
- [4] *Top Curr Chem.* **2015**, *360*, 1-38
- [5] *Antimicrobial Agents and Chemotherapy* **2003**, *47*, 2823-2830

## Acknowledgements

This work was supported by the Russian Science Foundation (project No 23-23-00158).

## ALTERNATIVES TO RECYCLING HEPTYL INTO A PRACTICALLY VALUABLE BIOLOGICALLY ACTIVE COMPOUND

Ivanova E.S.<sup>1</sup>, Nasakin O.E.<sup>1</sup><sup>1</sup> Ulyanov Chuvash State University, Cheboksary, Russia  
Student[lizachimic@mail.ru](mailto:lizachimic@mail.ru)

The high toxicity and teratogenicity of asymmetric dimethylhydrazine (heptyl rocket fuel) caused the transition of rocket systems (in particular, Angara [1]) to gaseous fuel. However, the issue of recycling large amounts of "aqueous" heptyl does not lose its relevance. We propose its wide introduction into fine organic synthesis, in particular through the formation of hydrazones of unsaturated aldehydes, which are in great demand in medicine [2-4]. In addition, the latter were used by us for unusual reactions of 2+2 cycloaddition. For example, the reaction of tetracyanoethylene with dimethylhydrazine of croton aldehyde proceeds under standard conditions, without ultraviolet radiation or heating, with the formation of hard-to-reach cyclobutane. Below is the X-ray structure of the resulting white substance with a yield of 80%, i.e. - 103-105 °C. The resulting compound is currently being tested.

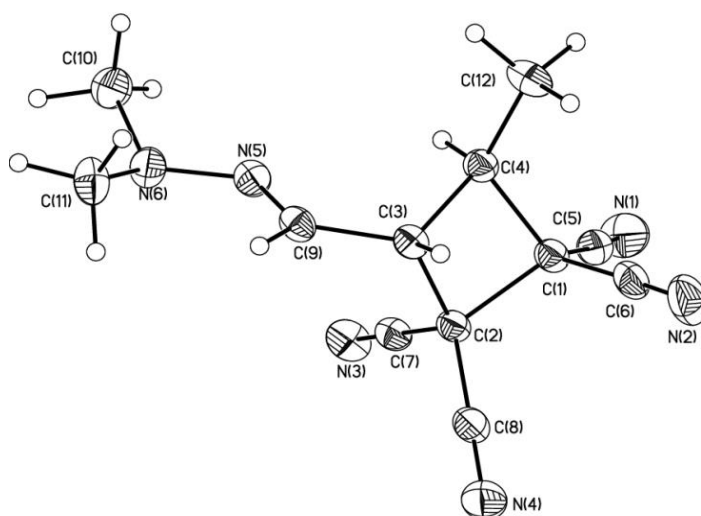

**Scheme 1.** The crystal structure obtained by X-ray diffraction analysis.

### References

- [1] "The Angara launch vehicle State". Khrunichev. Archived from the original: [website]. – URL <https://web.archive.org/web/20170118135419/http://www.khrunichev.ru/main.php?id=44> (date of access: 07/25/2009) – Text : electronic.  
 [2] *Org. Lett.* **2019**, 21, 4245–4249  
 [3] *Bioorg. Med. Chem.* **2004**, 12, 3987–3994.  
 [4] *Molecules* **2021**, 26, 1330

### Acknowledgements

This work was supported by the Russian Science Foundation (project No 23-23-00656).

MICROWAVE-ASSISTED SYNTHESIS OF ACETYLENE AND BENZENE  
IN CONTROLLED METHANE-PLASMA SYSTEM

*Kapustin R.V.<sup>1</sup>, Agrba A.I.<sup>1</sup>*

<sup>1</sup> Nizhny Novgorod State Technical University n.a. R.E. Alekseev, Nizhny Novgorod, Russia  
Postgraduate  
[kapustin-nttu@mail.ru](mailto:kapustin-nttu@mail.ru)

Microwave non-thermal plasma is generated by irradiating a mixture of electrons, ions, and neutral gas molecules with wavelengths ranging from 1 mm (300 GHz) to 1 m (300 MHz). It can be produced using various gases, at different power levels and system pressures. In the present work, we propose an original scheme of experimental setup and technology for microwave-activated plasma methane conversion into acetylene and benzene. Our microwave reactor features a multimode resonant cavity that is illuminated through one sidewall using a rectangular transverse electric waveguide. The waveguide has an interior aspect ratio of 2:1 and contains a packaged cavity magnetron operating at 2.45 GHz. No additional impedance-matching apparatus is used between the magnetron and the multimode resonant cavity. A system of two active plasma zones was evaluated in the reactor. One of these zones is the 'hot' zone, where plasma generates the active elements, and the other is the 'relaxation' zone, where the synthesis of organic products occurs (Fig. 1).

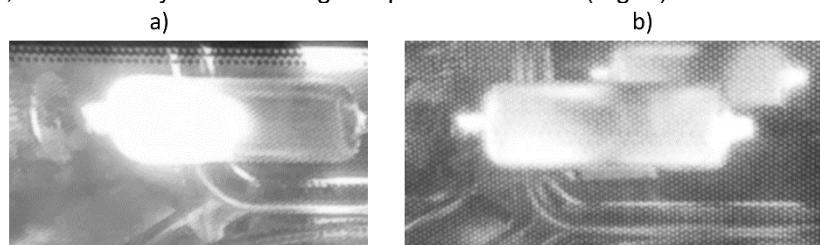

**Figure 1.** The 'hot' and 'relaxation' zones under different conditions:  
a) middle-divided same-volume zones; b) middle-relaxed 'hot' zone.

The temperature of the blowing gas provides heat removal from the walls, and methane preheating controls the conversion process. These operating factors can be applied separately or in combination. The temperature of the gas has certain optimal points for the selective conversion of methane into the definite products. The pressure in the reactor is the main factor for achieving the highest yield (80% for acetylene), varying within a 30–40 mbar interval. The plasma burning time is also an essential factor in methane conversion, with an optimal time of 15 seconds in stationary mode. The application of flow-rate mode in 5–15 m<sup>3</sup>/h interval increases in some degree the yield of organic product, whereas providing the growth of its quantities at relatively low operating methane pressure in reactor. A general qualitative model of methane reforming in these conditions is suggested in the work, with methane dehydration in plasma flame and direct synthesis of acetylene from coal particles and hydrogen atoms in the relaxation zone playing the main roles. Benzene formation occurs through the trimerization of excited acetylene molecules under heat dissipation near the reactor walls. The highest benzene yield achieved was 50%, which is a highly encouraging result, as is the case with acetylene, particularly given that the conversion was performed using a non-catalytic method. Furthermore, this represents a unique accomplishment in that the simultaneous production of acetylene and benzene from methane with significant yields has never been achieved before. A low-temperature IR monitoring system, combined with a separation module, enables the identification, extraction, and purification of conversion products. The presented microwave-assisted plasma chemical technology has considerable potential for industrial implementation, due to its energy efficiency, high selectivity, environmental friendliness, straightforward scalability, and adaptability.

#### Acknowledgements

This work is dedicated to the memory of Alexander M. Klushin, Doctor of Sciences, who proposed the idea for this work. The authors would like to express their gratitude to Mikhail S. Gitlin, Doctor of Sciences, for his consultations during the work's development. This work was supported by the Ministry of Science and Higher Education of the Russian Federation (Project No. FSWR-2022-0008), the Ministry of Education and Science of the Nizhny Novgorod region (Agreement No. 316-06-16-92a/23 dated July 4, 2023), and the Foundation for Assistance to Small Innovative Enterprises (Agreement No. 1934GSSS15-L/88212 dated September 22, 2023).

## SYNTHESIS OF DINITRODIARYLAMINES – STRUCTURAL FRAGMENTS OF PHOTOLABILE GROUPS

Kazantsev D.A.<sup>1</sup>, Denisov A.A.<sup>1</sup>, Pestov A.V.<sup>1</sup>

<sup>1</sup> I.Ya. Postovsky Institute of Organic Synthesis of the Ural Branch of the Russian Academy of Sciences (IOS UB RAS)  
[daniil\\_kazantsev@mail.ru](mailto:daniil_kazantsev@mail.ru)

At this moment, maskless photolithography is the most promising method of creating biochips. This method allows you to create micro devices using simple equipment, but has high requirements for the photochemical properties of the protective groups used. They must have a good ability to absorb ultraviolet radiation and provide a high quantum yield in photodeprotection reactions. At the same time, the synthesis of protective groups should be carried out simply and from available materials. Derivatives of 2-(2-nitrophenyl)propyloxycarbonyl (NPPOC group) are most suitable for this task. Thus, using a photolabile protective group based on (3-ethyl-4-nitrophenyl)phenyl ketone (BzNPPOC), a method for synthesizing a high-density DNA chip was developed [1].

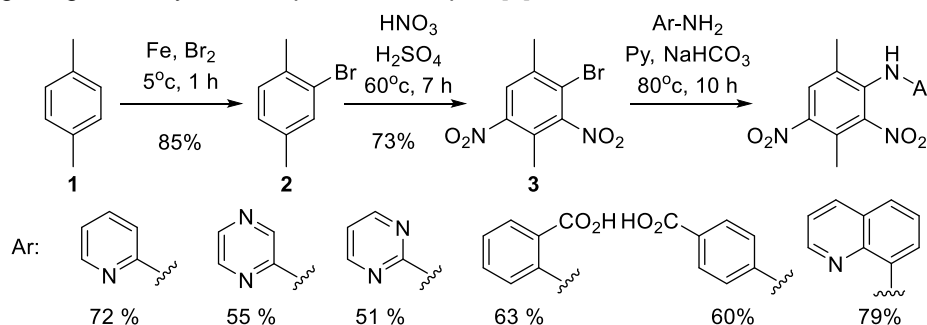

**Scheme 1.** The scheme of synthesis of aromatic nuclei.

The main disadvantage of photolabile protecting groups of such structure is the position of the absorption peak of electromagnetic radiation in the midwave ultraviolet region. For example, the absorption maximum of BzNPPOC is located at 300 nm [1]. It is known that the introduction of mesomeric donor substituents, as in the case of SPh-NPPOC, leads to a bathochromic shift of the absorption peak to the near-UV region [1]. At the same time, the insertion of a second nitro group into the aromatic system allows increasing the quantum yield of the photodeprotection process [2], and also contributes to the shift of the absorption peak to the long-wavelength region [3].

The aim of this work is to develop a method for the synthesis of aromatic nuclei of photolabile protecting groups capable of absorbing electromagnetic radiation in the near-UV region.

1,4-dimethylbenzene (**1**) was chosen as a starting compound. At the first stage of synthesis it was possible to obtain the bromo derivative **2** in good yield. The use of excess nitrating mixture during nitration of compound **2** allowed regioselective introduction of nitro groups into the aromatic system in ortho- and para-positions with respect to bromine, which significantly increased the reactivity of the structure in nucleophilic aromatic substitution reactions. At the same time, both nitro groups were introduced into ortho-positions with respect to one of the methyls, which should increase the quantum yield of the photodeprotection reaction of the oxycarbonyl derivative. The regioselectivity of the nitration process of structure **2** is due to the coordinated orientation of the substituents. The structure of compound **3** was confirmed by <sup>1</sup>H NMR and IR spectroscopy and X-ray diffraction analysis.

The optimal conditions for the reaction of nucleophilic aromatic substitution of bromine by anilines in compound **3** were found to be heating of the substrate with 2 excess of amine in pyridine at 80 °C for 10 h. The composition and structure of the obtained diarylamines were characterized by elemental analysis, IR- and <sup>1</sup>H NMR spectroscopies. The electromagnetic absorption ability was studied by absorption spectroscopy.

### References

- [1] *Angew. Chem. Int. Ed.* **2015**, 54(29), 8555-8559  
 [2] *Chem. Rev.* **2013**, 113(1), 119–191  
 [3] *J. Am. Chem. Soc.* **1991**, 113(11), 4303–4313

### Acknowledgements

This work was supported by the Russian Science Foundation (project No 24-26-00162).

MODELING OF THE REACTION MECHANISM OF NITRATION OF  
IMIDAZO[4,5-E]BENZO[1,2-C;3,4-C']DIFUROXANE WITH ACETYL NITRATE BY QUANTUM  
CHEMISTRY METHODS

Kudryavtsev T.A.<sup>2</sup>, Kobyakova M.E.<sup>1</sup>, Korolev V.L.<sup>1</sup>, Zavarzin I.V.<sup>2</sup>

<sup>1</sup> Kursk State University, Kursk, Russia

<sup>2</sup> N.D. Zelinsky Institute of Organic Chemistry of the Russian Academy of Sciences, Moscow, Russia

Student

[kobyakova.masha@inbox.ru](mailto:kobyakova.masha@inbox.ru)

Effective compounds inhibiting platelet aggregation due to their ability to generate nitric oxide have been obtained on the basis of imidazo[4,5-e]benzo[1,2-c;3,4-c']difuroxane.

To optimize the production of C-nitroimidazo[4,5-e]benzo[1,2-c;3,4-c']difuroxane [1], various ways of nitration reaction with 1 acetyl nitrate in the Gaussian09 software package by DFT B3LYP/6-311G++(d,p) in the gas phase were analyzed.

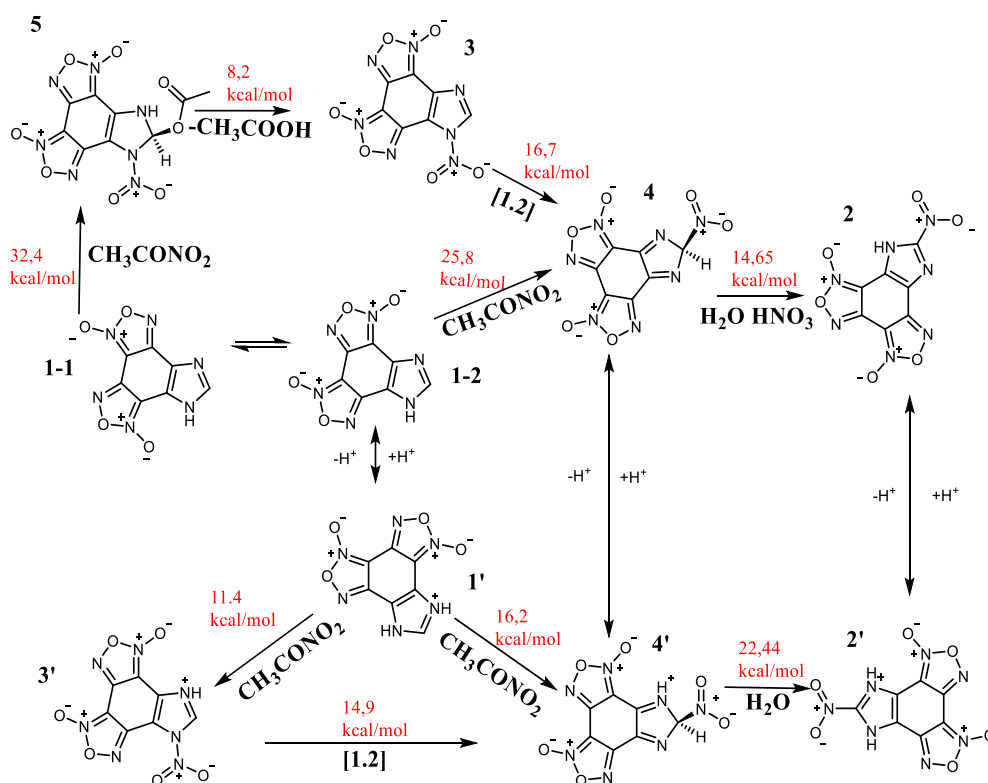

Scheme 1. Ways of nitration reaction.

The results of quantum chemical calculations showed that reaction stages 1→3, 1→4, and 3→4 are an acid-catalyzed process, unlike stage 4→2, thus, the most energetically advantageous chain of transformation is 1'→3'→4'→4→2

### References

[1] Alekseev A.A. *Development and research of a drug based on new peptide inhibitors of platelet aggregation: abstract of the thesis.... Candidate of Pharmaceutical Sciences 2015*, 11

## REACTION OF QUINOID DERIVATIVES OF PYRIDO[1,2-A]BENZIMIDAZOLE WITH N-ACETYL-CYSTEINE

Kurbanova G.A.<sup>1</sup>, Slabko O.Y.<sup>1</sup><sup>1</sup> Far Eastern Federal University, Vladivostok, Russia  
Student[kurbanova.ga@dvfu.ru](mailto:kurbanova.ga@dvfu.ru)

Heterocyclic quinoid compounds are theoretically interesting, this is justified by their high and unique reactivity, moreover, the compounds are of practical value as biologically active substances. Many heterocyclic quinoid structures are part of several antibiotics and phytotoxins and exhibit insecticidal and antitumor properties [1]. On the other hand, pyridobenzimidazole is a kind of pharmacophore base for a few drugs that exhibit analgesic, antiviral, antifungal, and antibacterial properties [2].

It was of interest to us to introduce an amino acid fragment into the molecule of the quinoid derivative of pyrido[1,2-a]benzimidazole. On the one hand, this can lead to a change in the biologically active properties of these compounds, and on the other hand, the introduction of a dipole will necessarily lead to an increase in water solubility, which is an important requirement for biologically active drugs. To introduce an amino acid fragment, it was decided to lead a nucleophilic reaction with an amino acid derivative, N-acetylcysteine (NAC), widely known for its mucolytic and antioxidant properties [3].

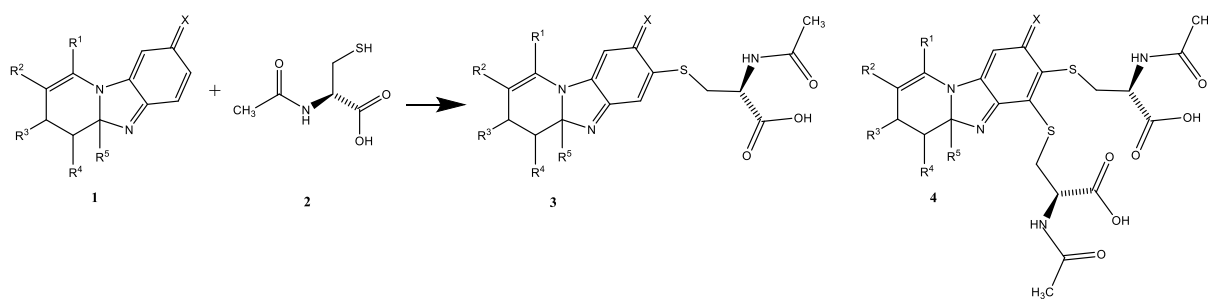

- a. X = O, R<sup>1</sup>=R<sup>3</sup>=Ph, R<sup>2</sup>=H, R<sup>4</sup>,R<sup>5</sup>=(CH<sub>2</sub>)<sub>4</sub>; b. X = O, R<sup>1</sup>=R<sup>3</sup>=R<sup>5</sup>=Ph, R<sup>2</sup>=R<sup>4</sup>=H; c. X = N-Ph, R<sup>1</sup>=R<sup>3</sup>=Ph, R<sup>2</sup>=H, R<sup>4</sup>,R<sup>5</sup>=(CH<sub>2</sub>)<sub>4</sub>;  
d. X = N-C<sub>6</sub>H<sub>11</sub>, R<sup>1</sup>=R<sup>3</sup>=Ph, R<sup>2</sup>=H, R<sup>4</sup>,R<sup>5</sup>=(CH<sub>2</sub>)<sub>4</sub>; e. X = C(CN)<sub>2</sub>, R<sup>1</sup>=R<sup>3</sup>=Ph, R<sup>2</sup>=H, R<sup>4</sup>,R<sup>5</sup>=(CH<sub>2</sub>)<sub>4</sub>.

**Scheme 1.** Scheme of the interaction of quinoid derivatives of pyridobenzimidazole with NAC.

Reactions of NAC with quinone monoimines, quinone diimines and methylene quinone imines of the pyrido[1,2-a]benzimidazole series were carried out. Mono- and di-addition products were obtained. Based on the studies, it was concluded that quinone imines react with NAC, forming products of 1,4-nucleophilic addition to position 7 of the quinoid system and then to position 6. All products are water soluble. The compounds are currently being tested for biological activity.

## References

- [1] *J. Med. Chem.* **1994**, *37*, 710-712  
[2] *Usp. Chem.* **2013**, *82*, 77-97  
[3] *Free Radic. Biol. Med.* **2019**, *6*, 593-597

## INCONSISTENCY OF THE TEXTBOOK MECHANISTIC HYPOTHESIS OF THE MIZOROKI-HECK REACTION WITH AND KINETIC DATA

Lagoda N.A.<sup>1</sup>, Larina E.V.<sup>1</sup>, Kurokhtina A.A.<sup>1</sup>, Schmidt A.F.<sup>1</sup><sup>1</sup> Irkutsk State University, Irkutsk, Russia

Junior researcher

[kurokhtina@chem.isu.ru](mailto:kurokhtina@chem.isu.ru)

Currently, the generally accepted mechanistic hypothesis of the Mizoroki-Heck reaction in both “classical” (with aryl halides) and oxidative (with arylboronic acids) modes implies the formation of the reaction products according to the so-called linear mechanism of the catalytic cycle [1], which involves sequential transformations of palladium-containing intermediates. However, previously, in the competing experiments with a pair of alkenes and one common aryl halide in “classical” reaction mode (Scheme 1a), we obtained data indicating that the differential selectivity (DS) of competing alkenes did not depend of the nature of the aryl substituent and the halide counterion of the aryl halide [2]. These data were inconsistent with linear mechanistic hypothesis suggesting the interaction of competing alkenes with an aryl palladium intermediate (ArPdX), formed as a result of aryl halide oxidative addition to catalytically active Pd(0) complexes. In our opinion, the most likely explanation for the observed patterns was the formation of the reaction products according to the so-called cooperative (nonlinear, from kinetic viewpoint) mechanism of catalysis (for more details, see [2]).

We verified a probable realization of the patterns observed in “classical” Mizoroki-Heck reaction with aryl halides in the so-called “oxidative” version of the process using arylboronic acids as arylating reagents (Scheme 1b). The differential selectivity of competing alkenes was again insensitive to varying the nature of the aryl substituent in the arylation reagent, i.e., arylboronic acid, which is consistent with the formation of the reaction products by a nonlinear cooperative mechanism of catalysis.

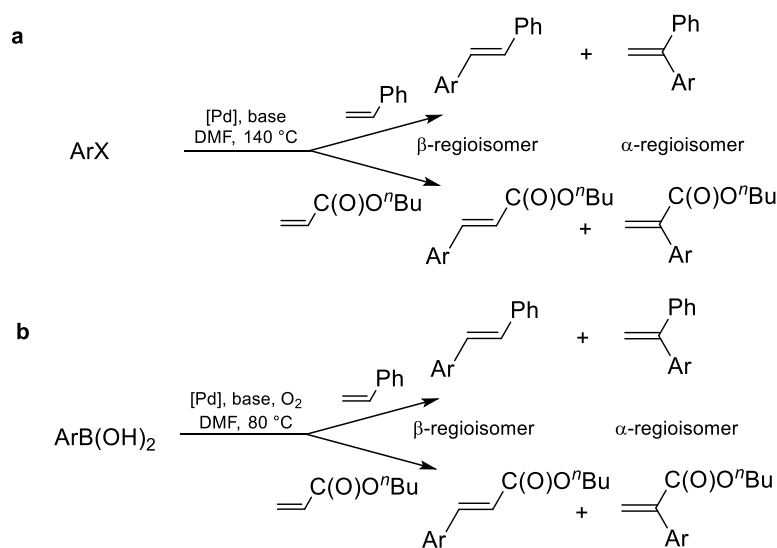

**Scheme 1.** “Classical” (a) and oxidative (b) competing Mizoroki-Heck reactions with two alkenes.

Note, that the patterns of the differential regioselectivity of the product of α- and β-arylation of one alkene were different for “classical” and oxidative modes of Mizoroki-Heck reaction. This allowed proposing distinct types of the conjunction between the elementary steps of the catalytic cycles determining the DS of competing alkenes and the differential regioselectivity of α- and β-arylation products when aryl halides or arylboronic acids were used as arylating agents in Mizoroki-Heck reaction.

## References

- [1] *The Mizoroki–Heck Reaction*. Ed. by M. Oestreich. **2011**, John Wiley & Sons, Ltd. 587 p  
 [2] *ChemCatChem* **2020**, *12*, 5523

## Acknowledgements

This work was supported by the Russian Science Foundation (project No 23-23-00035).



ASSESSMENT OF PHYSIOLOGICAL ACTIVITY OF POTENTIAL DRUG SUBSTANCES BY  
CHROMATOGRAPHIC AND OPTICAL METHODS

*Marinich I.I., Chzhu O.P., Aravishvili D.E.*

Kurchatov Complex of Medical Primatology National Research Centre 'Kurchatov Institute', Sochi,  
Russia

Postgraduate student

[olga.chzhu@mail.ru](mailto:olga.chzhu@mail.ru)

According to the IUPAC classification, medicinal chemistry is currently defined as a field of chemical science 'associated with the detection, development, identification and investigation of the mechanism of action of biologically active compounds at the molecular level'.

For all drugs without exception, the so-called pharmacokinetics (kinetic patterns of excretion of drugs from living organisms) and for some - pharmacodynamics (mechanisms of their action, including metabolism) must be established. The use of modern analytical methods is indispensable.

In modern medicine analytical methods have found wide application. The most widespread are methods of analysing biological fluids and tissues, many of which have become routine. By combining complementary and independent physical and physico-chemical methods it is possible to analyse the activity of drugs without sample preparation and standard samples more economically, reliably, more accurately and faster than by pharmacopoeial methods GF RF XIII.

The key factor of diagnostic value of new methods is the specificity of analytes as biomarkers of a certain biological process (in particular, pathology or risk of its occurrence). The concept of 'biomarker' is multifaceted, but in the context of analytical chemistry, biomarkers refer to changes in the profiles of certain substances in certain biological media that are registered by means of chemical analysis. As a rule, biomarkers of a disease or response to a certain effect that can provoke the development of a disease are established as a result of statistical processing of extensive but still limited arrays of experimental data.

In this work we evaluated the activity of the preparation of aminodihydrophthalazindione lyophilisate by its ability to quench aggressive forms of oxygen, using biomarkers of oxidative stress - malonic dialdehyde (MDA), superoxide dismutase (SOD), fat-soluble vitamins. Concentrations of biomarkers were determined by chromatographic and optical methods at different methods of drug administration to aged primates and primates with impaired liver enzymatic activity.

The dynamics of changes in the drug content in the blood of elderly primates was determined by the concentration of one of the dissociated forms in serum. The content of the drug 60 minutes after administration decreases threefold, and after 24 hours it becomes below the detection limit.

The concentration of MDA and fat-soluble vitamins in the blood of experimental animals was determined by high-performance liquid chromatography (HPLC) in gradient mode. The diode matrix detector allowed readings at several wavelengths. Application of HPLC method made it possible to record MDA concentrations for primates in a range inaccessible for classical ELISA methods. During the experiment, a pronounced decrease of MDA concentration in blood plasma was observed. This suggests a decrease in the activity of peroxidation processes and activation of antioxidant defence of the organism, which is especially important in ageing individuals.

The group was monitored for a year, and it should be noted that the oxidative stress indicator remained low.

SOD activity was determined by spectrophotometric method in the reaction of inhibition of adrenaline autooxidation in alkaline medium. When the drug was administered to primates with liver enzymatic activity disorders, an increase in the concentration of superoxide dismutase (SOD) was observed at the time of its administration with further return to background values. The concentration of malonic dialdehyde (MDA) changed extremely.

## STUDY OF THE HETEROGENEOUS CATALYTIC OXIDATION REACTION OF CHLOROBENZENES

*Melikova I.G\*, Aykan N.F., Efendi A.J., Faradjev G.M., Rustamova C.T., Aliyeva N.R.*

Institute of Catalysis and Inorganic Chemistry named after acad. M.Nagiyev of Ministry of Science and Education of Republic of Azerbaijan, Baku

[iradam@rambler.ru](mailto:iradam@rambler.ru)

The utilization of chlorinated derivatives of maleic anhydride in the heterogeneous catalytic oxidation reaction becomes interesting due to the fact that today one of the industrial methods for producing maleic anhydride is the oxidation reaction of benzene. In addition, chlorobenzenes are also both targeted products and waste in many industries, the recovery of which is an urgent task. The selective oxidation of chlorobenzenes into chlorinated derivatives of maleic anhydride is also of theoretical interest in order to clarify the kinetic regularities and mechanism of the reaction. Mono-, di- and trichlorobenzenes were subjected to oxidation. Based on the compiled regression model, the influence of variable parameters on the oxidation reaction of chlorobenzenes was studied in the temperature range from 673 to 753 K, contact time from 0.2 to 1.0 s, and chlorobenzene:oxygen ratio from 1:5 to 1:50 mol. It should be noted that the catalytic system V–P–O/SiO<sub>2</sub>, which previously showed good results in the oxidation of chlorinated C<sub>4</sub> hydrocarbons, showed mediocre results in the oxidation of chlorobenzenes [1, 2].

V–Mo/Al<sub>2</sub>O<sub>3</sub> turned out to be the most active and selective catalyst in the oxidation reaction of chlorobenzenes; although the degree of conversion was quite high, the yield of targeted products on it did not exceed 15 mole% and the total yield of all the resulting anhydrides was no more than 30 mole%. However, it should be noted that when studying the oxidation reaction of chlorobenzenes, good results were achieved specifically on vanadium-molybdenum catalysts. Taking this into account and the inexhaustible capabilities of these catalysts, research in this direction should be carried out in the future using various promoters to increase the yields and selectivity of the targeted products in the chlorobenzene oxidation reaction.

Thus, the results of studying the kinetic regularities of the reaction of heterogeneous catalytic oxidation of chlorohydrocarbons make it possible to draw the following conclusions:

- The targeted system of oxide catalysts that exhibits high activity and selectivity in the heterogeneous catalytic oxidation reaction of chlorohydrocarbons was selected and synthesized based on a reasonable approach. It was revealed that the synthesized V–P–O/SiO<sub>2</sub> catalytic system has high selectivity in the oxidation reaction of chlorohydrocarbon (ChH). It has been established that the nature and properties of the substrate, as well as the V:P ratio significantly affect the activity and selectivity of the oxidation reaction.

It has been established that the carrying out heterogeneous catalytic oxidation of carbon dioxide in a fluidized bed of catalysts is more effective considering its advantage over a stationary bed.

The conditions for the oxidation reaction of ChH were optimized, the regression equations for the studied groups of ChH were estimated, the coefficients of the regression equation were calculated, their significance was assessed, and the adequacy of the resulting model to the experimental data was tested.

The optimal variation intervals of technological parameters for carrying out the reaction of heterogeneous catalytic oxidation of saturated ChH (C<sub>1</sub>–C<sub>4</sub>) have been determined. It has been established that the activity of the studied catalytic systems in the oxidation reaction of saturated ChH varies in the following order: Co–Mo < V–P–O/SiO<sub>2</sub> < V–P–O/SiO<sub>2</sub>+Mg < V–Mo/Al<sub>2</sub>O<sub>3</sub> < V–P–O/Al<sub>2</sub>O<sub>3</sub>. Selectivity: V–P–O/Al<sub>2</sub>O<sub>3</sub> < V–Mo/Al<sub>2</sub>O<sub>3</sub> < V–P–O/SiO<sub>2</sub> < Co–Mo < V–P–O/SiO<sub>2</sub>+Mg.

Some correlations have been revealed between the number of chlorine atoms in the molecule and optimal parameters, as well as the conversion rate and selectivity of saturated ChH.

It has been established that during the oxidation of C<sub>2</sub>–C<sub>4</sub> chlorinated olefins on synthesized oxide catalysts with high conversion rate of the initial chemical compounds, the targeted products are obtained with low yields and selectivity. The position of the chlorine atoms and the double bond effects on selectivity of the products.

It has been established that the oxidation reactions of chlorobutadienes (di-, tri-, tetra- and penta-chlorinated) have common patterns.

### References

- [1] *Azerbaijan Chemistry Journal*, **2001**, 2, 13-18  
 [2] *Kinetics and catalysis*, **2020**, 61(4), 447-468

## ELECTROSURGICAL KNIFE FUNCTIONAL COATINGS BASED ON Ni-P ALLOYS

*Myagkova I.N.<sup>1</sup>, Evseev A.K.<sup>2</sup>, Polyakov N.A.<sup>1,3</sup>, Goroncharovskaya I.V.<sup>2</sup>, Kirsanov I.I.<sup>2</sup>, Drovosekov A.B.<sup>3</sup>, Kanibolotskiy A.A.<sup>2</sup>, Shabanov A.K.<sup>2</sup>*

<sup>1</sup> D. Mendeleev University of Chemical Technology of Russia, Moscow, Russia

<sup>2</sup> N.V. Sklifosovsky Research Institute for Emergency Medicine, Moscow, Russia

<sup>3</sup> Frumkin Institute of Physical Chemistry and Electrochemistry of the RAS, Moscow, Russia

PhD student

[cabbage-omm@mail.ru](mailto:cabbage-omm@mail.ru)

Currently, electrosurgery is one of the most common techniques in laparoscopic or endoscopic surgery due to its advantages such as reduced blood loss and rapid tissue separation [1]. However, the use of electrosurgical methods is associated with the tissue carbonization and sticking to the electrode, which can lead to rupture and damage to adjacent tissue and disturbance in hemostasis [2]. One of the methods for increasing the efficiency of electrosurgical methods is the development of functional coatings based on metals and their alloys. A topical issue in this area is the application of coatings that not only will reduce tissue adhesion, but also have increased wear resistance, which will increase the service life of electrodes under conditions of periodic cleaning using abrasive materials. Very promising in this case are coatings based on the Ni-P alloy, which have high corrosion resistance, hardness and decorative properties.

The purpose of this work is to evaluate the performance characteristics of electrosurgical knives with coatings based on Ni-P alloys.

In this work an electrosurgical unit ARC 350 (BOWA, Germany) in monopolar mode «Cut» (100 V) was used. A 5-cm-long incision of a tissue sample (muscle of the pelvic limb of a cow) was made using electrosurgical knife. The characteristics were assessed based on the results of a study of histological sections and the mass of carbon deposits on the electrode surface.

It was shown that the application of coatings based on Ni-P alloys makes it possible both to reduce the mass of tissue sticking to the surface of the electrode during the procedure and the depth of thermal damage (Fig. 1).

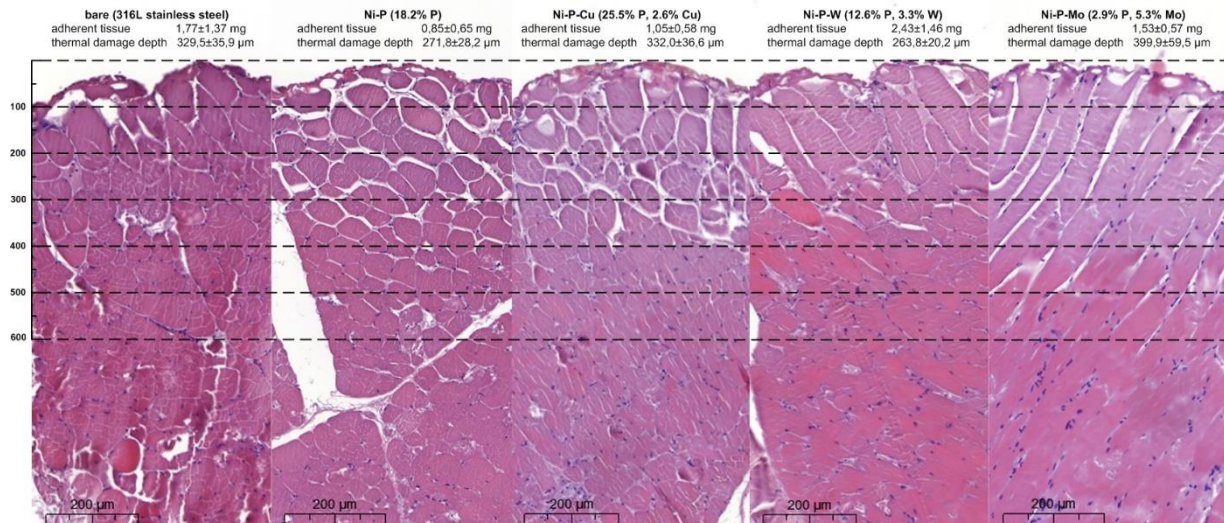

**Figure 1.** Histological sections of tissue exposed to an electrosurgical knife.

In a number of cases not only was noted reduce the mass of tissue sticking to the surface (Ni-P-Cu (25.5%/2.6%Cu), Ni-P-Mo (2.9%P/5.3%Mo)) or the depth of thermal damage (Ni-P-W(12.5%P/3.3%W)), but also the improvement in both directions (for example, Ni-P (18.2%)), that requires additional research on the influence of their properties on the performance characteristics.

## References

- [1] *J. Am. Coll. Surg.* **2006**, *202*, 520  
 [2] *Ultrasonics* **2018**, *84*, 126

## SYNTHESIS OF HYBRID COMPOUNDS BASED ON DERIVATIVES OF ISATIN AND HYDRAZIDES OF PHOSPHORYL CARBOXYLIC ACIDS

*Nikolaev A.Y.*<sup>1</sup>, *Lavrova O.M.*<sup>1</sup>, *Tagasheva R.G.*<sup>2</sup>, *Komunarova D.K.*<sup>1</sup>, *Gavrilova E.L.*<sup>1</sup>, *Bogdanov A.V.*<sup>1</sup>

<sup>1</sup> Kazan National Research Technological University

Master

[toxa150101@mail.ru](mailto:toxa150101@mail.ru)

For many years, the chemical compound isatin, along with its various derivatives, has aroused the interest of the scientific community. This interest is related to their diverse reactivity and the wide range of biological activity [1] that they can cause, such as antiviral [2], antibacterial [3], including antituberculous [4].

Among the many isatin derivatives, those containing C-N and C=N bonds, such as Mannich bases, Schiff bases, and hydrazones derived from isatin, are particularly noteworthy. The biological activity of these classes of compounds further expands the potential of isatin derivatives for therapeutic use [5-6].

The articles [7-8] describe schemes for the production of hybrid compounds including spatially hindered phenols and isatin, which have pronounced stabilizing activity during aging of chlorobutyl rubber and brombutyl rubber, as well as high bacteriostatic activity against *Staphylococcus aureus*, *Pseudomonas aeruginosa* and antimycotic activity against fungi of the genus *Candida* [9].

In addition, hydrazide derivatives of phosphorylacetic acid are highly appreciated for their extensive biological activity, as well as for their noticeable antioxidant effects, which are due to an unconventional mechanism of action. These derivatives are known for their potential nootropic, antidepressant, antiarrhythmic and anti-ischemic properties.

This has caused a growing interest in the creation of new multi-faceted hybrid compounds in which these derivatives are combined with substituted isatins. There is growing optimism that such "hybrid" molecules, especially those that combine substituted isatins with 2-(diphenylphosphoryl)acetohydrazide and (diphenylphosphoryl)formohydrazide can become powerful agents in the fight against oxidative stress, having neuroprotective effects and other types of biological activity. Within the framework of this study, new phosphoryl carboxylic derivatives of isatin containing an acylhydrazone segment associated with a diphenylphosphine oxide fragment were synthesized. It is assumed that this arrangement of functional groups contributes to the manifestation of high antioxidant activity of the molecule.

As a result of the interaction of isatines with hydrazides in solution and in the presence of a catalyst, acylhydrazones were obtained. The structure of the compounds was confirmed using IR and NMR <sup>1</sup>H, <sup>31</sup>P spectroscopy methods. Some compounds are obtained as a mixture of two isomers due to the Z and E isomerism of C=N bonds, or hindered rotation around the N-C(O) fragment.

The proposed approach offers a promising way to obtain substances with antioxidant effects and other types of biological activity.

### References

- [1] *Bioorg. Med. Chem.* **2007**, *15*, 5888-5904
- [2] *J.Braz.Chem.Soc.* **2011**, *12*(3), 273-324
- [3] *Arkivok.* **2007**, *14*, 51-57
- [4] *Il Farmaco.* **2005**, *60*, 377-384
- [5] *Chemical Farm.journal* **1998**, *32*(2), 7-10
- [6] *Chemical Farm.journal* **1998**, *32*(2), 11-12
- [7] *Journal of General Chemistry* **2018**, *88*(1), 61-71
- [8] *Bulletin of the Technological University* **2022**, *25*(8), 84-92
- [9] *Bulletin of Kazan Technological University* **2010**, *10*, 91-95

## SPECTRAL PROPERTIES OF TOLANE, STILBENE, TERPHENYL AND THEIR SUPRAMOLECULAR COMPLEXES IN SOLUTION AND SILICATE HYDROGEL

*Novitskij G.O.*<sup>1,\*</sup>, *Medvedeva A.A.*<sup>1</sup>, *Koshkin A.V.*<sup>1</sup>, *Vedernikov A.I.*<sup>1</sup>, *Lobova N.A.*<sup>1,2</sup>

<sup>1</sup> National Research Center "Kurchatov Institute", Moscow, Russia

<sup>2</sup> Moscow Institute of Physics and Technology, Moscow, Russia

Postgraduate

[georg.nov97@gmail.com](mailto:georg.nov97@gmail.com)

It is known that conditionally rigid molecules with an internal cavity - cavitands - can accommodate a "guest" molecule inside the cavity, forming an inclusion complex (cavitate). In this case, the local microenvironment of the "guest" molecule changes, and cavitate begins to exhibit new physicochemical properties [1,2], different from the properties of the original molecules.

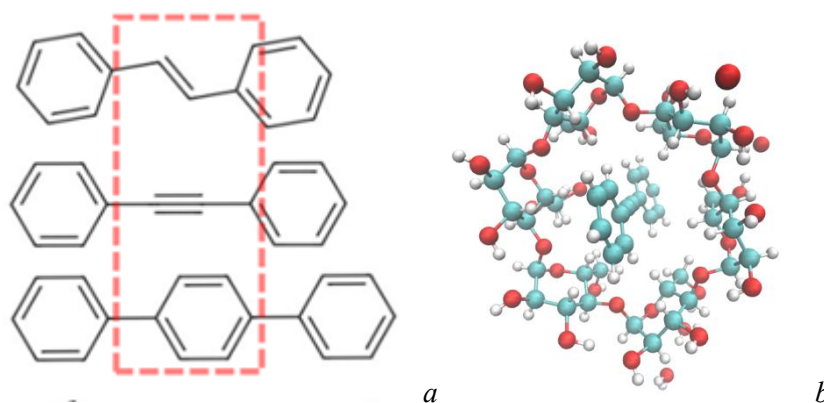

**Scheme 1.** (a). Structures of aromatic hydrocarbons with sp<sup>2</sup> and sp-hybrid linkers (b). Structure of the supramolecular complex of toluene with cyclodextrin obtained by X-ray diffraction.

The process of complexation of toluene, stilbene and terphenyl with  $\alpha$ ,  $\beta$ ,  $\gamma$ -cyclodextrins in water, an aqueous-ethanol solution and a silicate hydrogel based on tetrakis(2-hydroxyethyl)orthosilicate was studied. Complexation in solutions was confirmed by electronic and <sup>1</sup>H NMR spectroscopy data; the stability constants of the complexes were determined by spectrofluorimetric titration. The safety of the inclusion complex during the preparation of the gel was confirmed by electron spectroscopy data.

#### References

[1] *J. Phys. Chem. B.* **2006**, *110*, 16428-16438

[2] *ACS Photonics* **2020**, *7(8)*, 2132-2138

SYNTHESIS AND STRUCTURE OF *TRIS*(2,6-DIMETHOXYPHENYL)HYDROXYANTIMONY PERCHLORATEPlankina E.S.<sup>1</sup>, Egorova I.V.<sup>1</sup>, Grinishak I.P.<sup>1</sup>, Makeeva L.N.<sup>1</sup><sup>1</sup> Federal State Budgetary Educational Institution of Higher Education "Blagoveshchensk State Pedagogical University", Amur Region, Blagoveshchensk, Russia

Postgraduate student

[bgpu.chim.egorova@mail.ru](mailto:bgpu.chim.egorova@mail.ru)

Organoantimony functionalized compounds are of great synthetic interest as "building blocks" for more complex supramolecular structures. The objects of our systematic study are derivatives of *tris*(2,6-dimethoxyphenyl)antimony. A method for obtaining the *tris*(2,6-dimethoxyphenyl)hydroxyantimony perchlorate by interaction of *tris*(2,6-dimethoxyphenyl)hydroxyantimony bromide with sodium perchlorate in an aqueous solution is known [1].

We have established that the interaction of *tris*(2,6-dimethoxyphenyl)antimony dibromide with silver perchlorate in moist ethanol, in a ratio of starting reagents of 1:2, proceeds with the formation of *tris*(2,6-dimethoxyphenyl)hydroxyantimony perchlorate **I** according to the scheme:

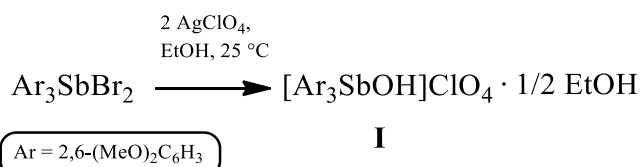

**Scheme 1.** Synthesis of *tris*(2,6-dimethoxyphenyl)hydroxyantimony perchlorate.

The compound crystallizes as a solvate with ethanol. Structure **I** was first determined by single-crystal X-ray diffraction and further confirmed by elemental analysis and infrared spectroscopy data.

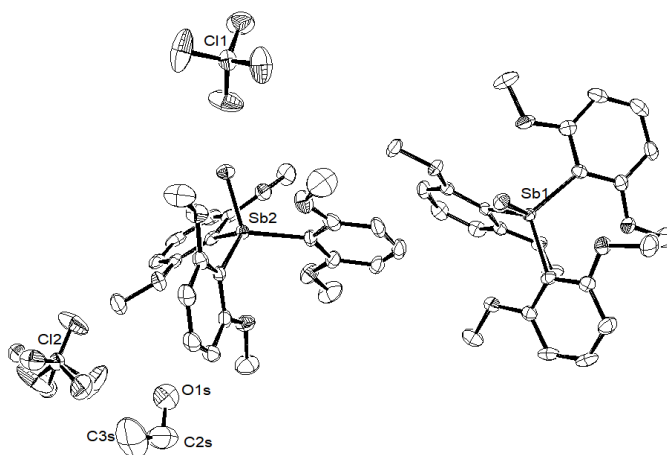

**Figure 1.** An ORTEP drawing of **I**, thermal ellipsoids drawn at 50% probability level, hydrogen atoms removed for clarity. Showing the numbering of principal atoms.

According to X-ray diffraction data, crystal **I** is formed by cations  $[\text{Ar}_3\text{SbOH}]^+$  and perchlorate anions  $\text{ClO}_4^-$ , forming ion pairs. The coordination of antimony atoms in the cations is close to tetrahedral. The crystalline structure is additionally stabilized by the formation of weak hydrogen bond  $\text{O}-\text{H}\cdots\text{O}$  interactions.

## References

[1] *J. Organomet. Chem.* **1996**, 507, 53

## SYNTHESIS OF NITROGEN-CONTAINING DERIVATIVES OF 2,1,3-BENZOTELLURADIAZOLE

*Ponomorev I.S.*<sup>1,2</sup>, *Yunusova P.R.*<sup>2</sup>, *Ivanenko T.Y.*<sup>1</sup>, *Rubaylo A.I.*<sup>1</sup>, *Lutoshkin M. A.*<sup>1</sup>

<sup>1</sup> Institute of Chemistry and Chemical Technology SB RAS, Krasnoyarsk, Russia

<sup>2</sup> Siberian Federal University, Krasnoyarsk, Russia

Graduate student

[il.ponomarew@yandex.ru](mailto:il.ponomarew@yandex.ru)

Derivatives of various 2,1,3-benzohalcoygenediazoles and betadiketonate esters, such as ethyl-3-oxobutanoate, are among the most promising compounds for the synthesis of polydentate ligands, which contain coordination centers of various natures, for example, heterocycles. Due to their electronic properties, their derivatives can be used to produce luminescent materials [1], molecular conductors [2], biologically active substances [3] and precursors to catalysts [4]. However, despite the fact that many different methods of synthesis and modification of one of the chalcogenediazoles, 2,1,3-benzothiadiazole, are currently known, the coordination chemistry of tellurium containing benzodiazoles has not been adequately studied. Although the introduction of tellurium in place of sulfur in the cycle could give previously unknown properties or enhance existing ones.

In this regard, the aim of the work is to develop effective methods for the synthesis of 2.1.3-benzotellurodiazoles, as well as ketoimines containing acetoacetic ether.

Substituted tellurium benzotriazoles were obtained using the following procedure. Diaminobenzene was introduced into a cycle closure reaction with tellurium (IV) oxide. With further nitration and reduction of the resulting benzodiazole. The resulting triaminobenzene was reintroduced into a cycle closure reaction with tellurium(IV) oxide.

The resulting 4-amino-2,1,3-benzotelluradiazole reacts with substituted acetoacetic ether to produce ketoimines. All the compounds obtained were characterized by NMR spectroscopy and mass spectrometry.

Compounds:

1. NMR<sup>1</sup>H(CHCl<sub>3</sub>, 600 MHz): 8.11 m. (H, BTD), 7.95 m. (H, BTD), 7.43 m. (H, BTD); Agilent 7000A (HP-5ms): 279(100)[M]<sup>+</sup>, 277(93,42), 275(57.49), 271(7.62); Yield 80%.

2. NMR<sup>1</sup>H(CHCl<sub>3</sub>, 600 MHz): 7.46 m.(H, BTD), 7.24 m.(H, BTD), 6.88 m.(H, BTD), 5.47 c.(2H, NH<sub>2</sub>); Agilent 7000A (HP-5ms): 249(100)[M]<sup>+</sup>, 247(93,55), 245(57.49), 241(7.62); Yield 62%.

3. NMR<sup>1</sup>H(CHCl<sub>3</sub>, 600 MHz): 8.26 d.(2H, Ph), 7.97 d.(2H, Ph), 7.74 c. (H, NH), 7.56 m. (H, BTD), 7,36 m. (H, BTD) 7.19 m.(H, BTD), 5.69c. (H, CH), 4.15 m.(2H, CH<sub>2</sub>), 1.27 d.(3H, CH<sub>3</sub>); Agilent 7000A (HP-5ms): 468.01 (100.0) [M]<sup>+</sup>, 466.01 (92.4), 464.00 (54.3), 463.01 (22.9), 469.01 (18.4); Yield 72%.

4. NMR<sup>1</sup>H(CHCl<sub>3</sub>, 600 MHz): 7.67 c. (H, NH), 7.56 m. (H, BTD), 7.46 d.(2H, Ph), 7,36 m. (H, BTD) 7.16 d.(2H, Ph), 7.19 m.(H, BTD), 5.65 c. (H, CH), 4.18 m.(2H, CH<sub>2</sub>), 2.33 c.(3H, CH<sub>3</sub>,Ph) 1.29 d.(3H, CH<sub>3</sub>); Agilent 7000A (HP-5ms): 437.04 (100.0) [M]<sup>+</sup>, 435.04 (92.4), 433.04 (58.4), 438.04 (20.5), 436.04 (18.0); Yield 74%.

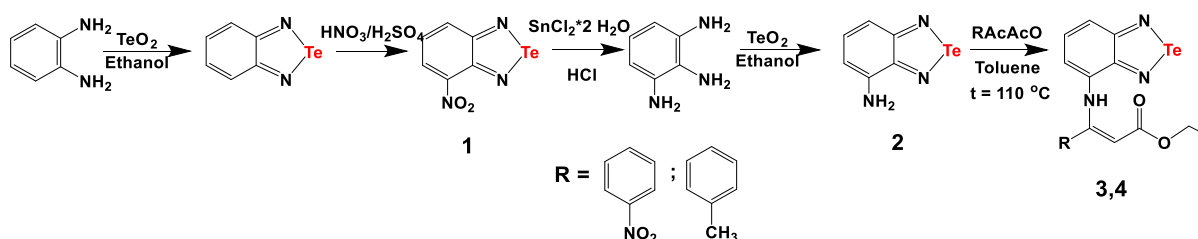

**Scheme 1.** Synthesis of chalcogenediazoles by stages.

### References

- [1] *RSC Adv.* **2016**, 6, 43901-43910  
 [2] *Synthesis* **2006**, 23, 3945-3947  
 [3] *The Urals. Unita*, **2014**, 204  
 [4] *J. Am. Chem. Soc.* **1970**, 92, 5118-5126

### Acknowledgements

The study was carried out within the framework of the state task FRS-2021-0012.

## COORDINATION COMPLEXES OF THE ORGANIC DYE VIOLANTHRONE WITH VARIOUS TRANSITION METAL COMPOUNDS

*Romanenko N.R.<sup>1</sup>, Faraonov M.A.<sup>1</sup>, Konarev D.V.<sup>1</sup>*

<sup>1</sup> FRC PCP MC RAS, Chernogolovka, Russia

Postgraduate student

[Nikita.romanov796@mail.ru](mailto:Nikita.romanov796@mail.ru)

Organic dyes (such as indigo, thioindigo, etc.) are currently used not only as industrial dyes, but also as components for the creation of functional materials (for example, photo- and semiconductors). The molecules of these substances are capable of redox transitions, due to which it is possible to introduce unpaired electrons, capable of participating in the implementation of conductivity or magnetic ordering of spins, into their structure. Moreover, dyes that have heteroatoms in their structure (for example, oxygen of the carbonyl group) are able to coordinate atoms of various metals. However, the number of organic dyes studied in reduction and coordination complexes with transition metals is still very limited. Mostly, they are limited to indigo-type dyes or chemically modified molecules based on them (the so-called "N-indigo derivatives").

In the course of this work, a number of coordination complexes based on the reduced form of violanthrone were synthesized and obtained in the form of single crystals for the first time. The resulting compounds were studied and characterized by X-ray diffraction analysis, IR and electron spectroscopy, and SQUID magnetometry.

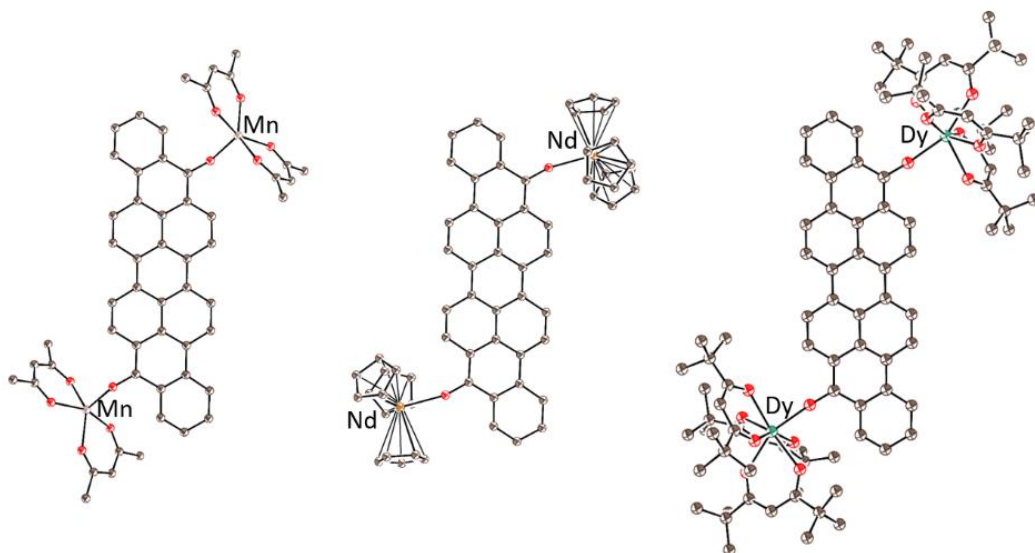

**Scheme 1.** Molecular structures of coordination dianion complexes of violanthrone: (a)  $\{\text{Violanthrone} \cdot [\text{Mn}^{\text{II}}(\text{acac})_2]_2\}^{2-}$ ; (b)  $\{\text{Violanthrone} \cdot [\text{Dy}^{\text{III}}(\text{TMHD})_3]_2\}^{2-}$ ; (c)  $\{\text{Violanthrone} \cdot [\text{Cp}_3\text{Nd}^{\text{III}}]_2\}^{2-}$ .

#### Acknowledgements

This work was supported by the Russian Science Foundation (project No 24-13-00060).



## DESIGN OF FERROELECTRIC METAL-ORGANIC FRAMEWORKS BY REPLACING SYMMETRIC LIGANDS WITH POLAR ONES

Shmelev A.A.<sup>1</sup>, Shaikhutdinov I.K.<sup>1</sup>, Sokolov A.V.<sup>1</sup>, Alexandrov E.V.<sup>1</sup>

<sup>1</sup> Samara State Medical University, Samara, Russia

PhD

[shmelsasha@yandex.ru](mailto:shmelsasha@yandex.ru)

Ferroelectrics induce spontaneous polarization in a crystal, capable of reorientation under the influence of external fields. More than 300 ferroelectrics are known, including inorganic materials, organic compounds, liquid crystals and polymers. Polar metal-organic coordination polymers (MOCPs) occupy a place between inorganic and organic materials [1,2]. As hybrid systems, they benefit from structural diversity and self-assembly capabilities from inorganic and structural blocks such as metal ions, ligands, clusters, templating molecules and solvents. The introduction of movable polar components that acquire mobility in an electric field, molecular rotors, makes it possible to configure reoriented electric polarization in the MOCP structure. We demonstrated the replacement of components in the crystalline structure of UiO-66 MOCP without disrupting its topological bond order. Thus, the terephthalate ligand was replaced with a 2,5-pyridinedicarboxylate ligand in various proportions. This complication and polarization of the framework leads to the development of a set of physical and chemical properties: the changing of adsorption activity (with the application of N<sub>2</sub>, CO<sub>2</sub>, metronidazole) and the emergence of a response to a constant and alternating electric field. Such a strategy of responsive vehicles design is promising for targeted drug delivery.

Furthermore, the structural diversity of potentially polar perovskite-like MOCPs from the Cambridge Structural Database has been analyzed.

#### References

[1] *CrystEngComm.* **2022**, *24*, 2505

[2] *Chem. Eur. J.* **2021**, *27*, 9180

#### Acknowledgements

This work was supported by the Russian Science Foundation (project No 24-23-00162).

## REGULATION OF A HIGHLY CONSERVED PROTOONCOGEN USING microRNA

*Sivoplyas E.A.*<sup>1,2</sup>, *Kulikov A.M.*<sup>1</sup>

<sup>1</sup> Koltzov Institute of Developmental Biology of Russian Academy of Sciences, Moscow, Russia

<sup>2</sup> Moscow Pedagogical State University (MPGU), Moscow, Russia

PhD student

[sivoplyas-ekater@mail.ru](mailto:sivoplyas-ekater@mail.ru)

The *Ras85D* gene is the most well known proto-oncogene. Most research of carcinogenesis showed the participation of Ras family genes in the formation of malignant tumors. The *Ras85D* gene is an ortholog of human genes (*N-ras*, *K-ras* and *H-ras*) and belongs to the highly conservative gene: the nucleotide sequence is little variable from yeast to human. These genes were first discovered in rat sarcoma cells which led to the name of this group. RAS genes are involved in the regulation of cell division, normal and in pathologies. Mutation of these genes is found in nearly 15% of all cases of tumors of human tumor formation.

The *Ras85D* gene and the protein produced by it belongs to the *Ras* superfamily. Their participation in signal transmission from cell receptors to the MAP-kinase cascade is shown. In addition to this function, proteins in this family affect the state of the actin cytoskeleton, malignant transformation and other processes. However, data on the regulation of the gene's own transcriptional activity are very little known. The involvement of miRNAs in regulating gene expression activity of orthologous *Ras* gene has previously been shown to man. This process includes the participation of 17 microRNAs. For *Drosophila*, the influence of miRNAs on the expression of oncogenes previously was not shown. For invertebrates, data were obtained only for *Caenorhabditis elegans*.

1. Production of transgenic structures bearing the GFP reporter gene under the Heat Shock promoter, containing a 3'- untranslated region of the *Ras85D* gene with the presence / absence of the analyzed conservative sequence.

2. Getting transgenic flies.

3. Analysis of the degree of GFP reporter gene expression using a confocal laser microscope.

4. Expression score

**Results:** Were found sites of binding miRNA (mir-313, mir-92a, mir-312) with the investigated gene *Ras85D* in the region 3'-UTR.

Made transgenic construct containing the *GFP* gene and the 3'UTR of the *Ras85D* gene in *D. melanogaster* with the presence / absence of the analyzed conservative sequence.

Were obtained transgenic flies.

Was analyzed the degree of gene expression.

*Ras85D* is one of the most important housekeeping genes, functioning as a key component of the promitotic regulatory cascades. The gene product is involved in signal transduction from the receptor tyrosine kinases to transcription factors - the cell cycle regulators. Therefore, this gene is highly conserved, and most of non-neutral substitutions are discarded by selection leaving for analysis only neutral variability.

It is shown that the change of the transcription start site and the nucleotide sequence of the regulatory region of the gene in the early stages of the evolution of species from around the subgenus *Drosophila*.

### References

[1] *Genetica* **2006**, 128(1-3), 9-11

[2] *Drosophila Inform. Serv.* **1978**, 53, 79

[3] *Proc. Natl. Acad. Sci. U S A.* **2000**, 97(21), 42-11337

### Acknowledgements

This work was supported by the Russian Foundation for Basic Research (project No 16-34-00840 mol\_a).

INVESTIGATION OF THE STATE OF ASYMMETRIC MONO-HETERYL SUBSTITUTED PORPHYRINS CONTAINING RESIDUES OF BENZOXAZOLE, BENZOTHIAZOLE AND BENZIMIDAZOLE IN AQUEOUS SOLUTIONS. INTERACTION WITH ANIONIC SURFACTANT

*Skorobogatkina I.A.<sup>1,2</sup>, Lebedeva N.S.<sup>2</sup>, Syrbu S.A.<sup>1,2</sup>*

<sup>1</sup> Ivanovo State University of Chemistry and Technology, Ivanovo, Russia

<sup>2</sup> G.A. Krestov Institute of Solution Chemistry of the Russian Academy of Sciences, Ivanovo, Russia  
Student

[Irina.Sk.01@mail.ru](mailto:Irina.Sk.01@mail.ru)

Currently, porphyrins are used in various fields. Hydrophilic and amphiphilic porphyrin derivatives are used as photosensitizing drugs for PDT. The introduction of hydrophilic peripheral substituents (carboxyl, hydroxyl and sulfogroups) into the tetrapyrrole macrocycle provides solubility of compounds in aqueous solutions. However, porphyrins are prone to associate formation and aggregation, which limits the use of these compounds in the processes of photooxidation, photoinactivation and bio-visualization. Most of the research in this field has been conducted for symmetrical water-soluble porphyrins [1]. Asymmetric porphyrins may have higher selectivity in respect of pathogenic microflora. An important goal is to determine the conditions of existence of monomeric forms of asymmetric porphyrins in aqueous solutions under the influence of various environmental conditions, solubilizing and transport systems.

In this work, a study of the state of 5-[4'-(1",3"- benzothiazole-2"-yl)phenyl]-10,15,20-tris(4'-sulfophenyl)porphine, 5-[4'-(1",3"- benzoxazole-2"-il)phenyl]-10,15,20-tris(4'-sulfophenyl)porphine, 5-[4'-(N-methyl-1",3"-benzimidazole-2"-yl)phenyl]-10,15,20-tris(4'-sulfophenyl)porphine in aqueous solutions under changing environmental conditions, and also in the presence of anionic surfactant - sodium dodecyl sulfate (SDS). The study of the state of porphyrins was carried out using spectral analysis methods.

Previously, we showed [2] that in aqueous solutions, the studied sulfonated monoheteryl-substituted porphyrins predominantly form acid-base type associates. To shift the associative equilibria of porphyrin – porphyrin self-association towards the monomeric form of porphyrin, SDS of various concentrations was introduced into the analyzed solutions. It was found that porphyrin remains self-associated in the pre-micellar region (SDS concentration up to 0.002 mol/L). An increase in the concentration of SDS in porphyrin solutions contributes to an increase in the number of monomeric forms of porphyrin due to the deconstruction of porphyrin aggregates by surfactant molecules. It was revealed that the studied porphyrins are localized in SDS micelles. The studied porphyrins contribute to the formation of SDS micelles, reducing the CMC of SDS from  $8 \cdot 10^{-3}$  to  $2 \cdot 10^{-3}$  mol/L. The results of the work can be further used in the development of antimicrobial photodynamic inactivation techniques.

### References

[1] *Int. J. Mol. Sci.* **2021**, 22(2), 797

[2] *J. Mol. Liq.* **2023**, 383, 122181

### Acknowledgements

This work was supported by the Russian Science Foundation (project No 21-73-20140).

EFFECT OF POSITION B METAL SUBSTITUTION ON THE ACTIVITY OF  $\text{Yb}_x\text{B}_y\text{O}_z$  COMPLEX-OXIDE SYSTEMS IN CATALYTIC CRACKING OF PROPANE

*Smirnova S.S.<sup>1</sup>, Selivanova M.M.<sup>1</sup>, Seromlyanova K.A.<sup>1</sup>, Zaytseva M.M.<sup>1</sup>, Markova E.B.<sup>1</sup>*

<sup>1</sup> Peoples' Friendship University of Russia (RUDN), Moscow, Russia

Student, bachelor

[1132296964@pfur.ru](mailto:1132296964@pfur.ru)

The process of catalytic dehydrogenation of propane is one of the effective ways to reduce the greenhouse effect, and in addition to its environmental importance, it also has industrial importance, since catalytic dehydrogenation of light alkanes is by definition considered an alternative petrochemical method for obtaining olefins from simple and affordable raw materials [2]. The product of dehydrogenation – propylene is extremely often used in polymerization reactions in order to obtain the main component of most plastics – polypropylene. Along with this, propylene is oxidized to convert into unsaturated aldehyde – acrolein, unsaturated acrylic acid and its nitrile, which are also fundamental for the synthesis of polymers [3]. In addition, propene is used as a fundamental link for the production of large-scale precursors for the further production of phenol and acetone: isopropanol and cumene. The annual production of propene amounted to about 130 megatons in 2019 [4] and, according to analysts, will increase to 191 megatons by 2030.

It is known that in the process of thermal cracking of  $\text{C}_3\text{H}_8$ , the formation of products starts at temperatures above  $700^\circ\text{C}$ , and at  $750^\circ\text{C}$  the conversion rate is 2%, and when the temperature rises to  $800^\circ\text{C}$ , it reaches 20%. The main reaction products under these conditions mainly  $\text{CH}_4$  and  $\text{C}_2\text{H}_6$ . As a result of the studies, it was shown that when using catalysts based on synthesized  $\text{Yb}_x\text{B}_y\text{O}_z$  systems, propane conversion also significantly depends on the cracking temperature. In the presence of the studied complex-oxide catalysts, an increase in the degree of conversion of  $\text{C}_3\text{H}_8$  up to 99% at  $700^\circ\text{C}$  for  $\text{YbCrO}_3$  was observed (Fig. 1).

In addition to the reduction in conversion temperature, there is also a change in selectivity towards propylene compared to thermal cracking. (Fig. 1).

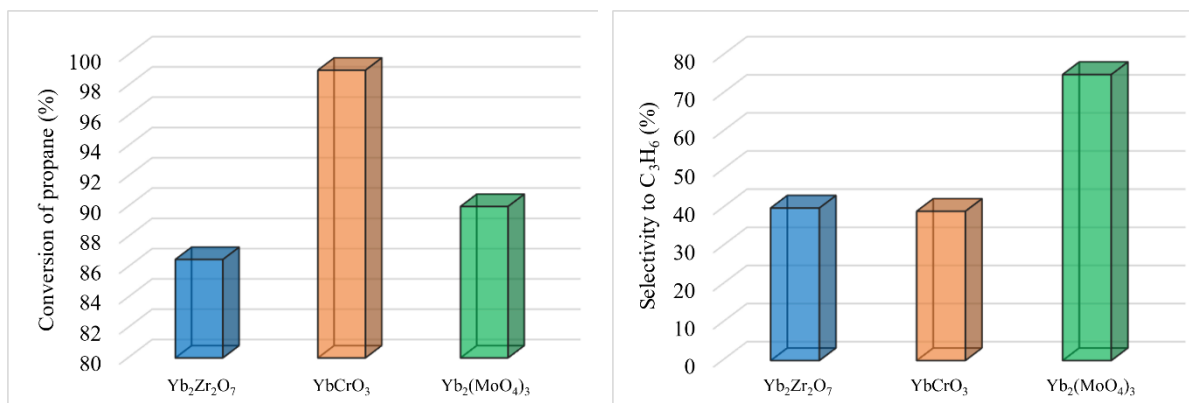

**Figure 1.** The degree of conversion of  $\text{C}_3\text{H}_8$  and the selectivity to  $\text{C}_3\text{H}_6$  at the optimal cracking temperature.

Thus, the maximum yield of  $\text{C}_3\text{H}_6$  belongs to the catalyst  $\text{Yb}_2(\text{Mo}_3\text{O}_4)_3$ . The selectivity for  $\text{C}_3\text{H}_6$  is 75% at a temperature of  $700^\circ\text{C}$ . Based on this, it can be concluded that complex oxides with such a crystalline structure as orthorhombic  $\beta'$ -phase are optimal for use in the dehydrogenation of propane in order to obtain propylene.

### References

- [1] *Chemical SOCIETY reviews* **2021**, 50, 3315  
 [2] *Aspects of Homogeneous Catalysis: A Series of Advances* **1984**, 75  
 [3] *Energy & Environmental Science* **2023**, 16, 2879

SUPPRESSION OF THE C<sub>60</sub><sup>•-</sup> DIMERIZATION BY  $\pi$ -STACKINGSobov P.A.<sup>1</sup>, Faraonov M.A.<sup>1</sup>, Konarev D.V.<sup>1</sup>

<sup>1</sup> Federal Research Center of Problems of Chemical Physics and Medicinal Chemistry RAS,  
Chernogolovka, Moscow region, Russia  
[pavelsobov479@gmail.com](mailto:pavelsobov479@gmail.com)

Radical anion salts of fullerenes have been obtained through the reaction of Cs·C<sub>60</sub> and Cs·C<sub>70</sub> with cationic dye (astrophloxine<sup>+</sup>)(I<sup>-</sup>) yielding crystalline salts (astrophloxine<sup>+</sup>)<sub>2</sub>(C<sub>60</sub><sup>•-</sup>)<sub>2</sub>·C<sub>6</sub>H<sub>4</sub>Cl<sub>2</sub>·C<sub>6</sub>H<sub>14</sub> (**1**) and (astrophloxine<sup>+</sup>)<sub>2</sub>(C<sub>70</sub><sup>•-</sup>)<sub>2</sub> (**2**). Salt **1** contains C<sub>60</sub><sup>•-</sup> radical anions arranged in 3D packing among which pairs of types I and II can be outlined. Strong antiferromagnetic coupling of spins is observed in the monomeric phase with Weiss temperature of -28 K. Partial dimerization of C<sub>60</sub><sup>•-</sup> is observed in the pairs of type I at 210-150K yielding a mixture of diamagnetic singly-bonded (C<sub>60</sub><sup>•-</sup>)<sub>2</sub> dimers and pairs of C<sub>60</sub><sup>•-</sup>. The reaction is accompanied by a decrease in the magnetic moment. Pairs of C<sub>60</sub><sup>•-</sup> of both types show no dimerization due to  $\pi$ -stacking. Monomeric C<sub>60</sub><sup>•-</sup> radical anions in the pairs are also separated by cations which form short H(astrophloxine<sup>+</sup>)...C(C<sub>60</sub><sup>•-</sup>) contacts and can hinder dimerization. Thus, despite close distances between C<sub>60</sub><sup>•-</sup>, they can dimerize only partially in **1**. Strong antiferromagnetic coupling between C<sub>60</sub><sup>•-</sup> is observed below 140 K, estimated exchange interaction ( $J/k_B$ ) is -24 K. Below 40 K antiparallel alignment of  $S = 1/2$  spins in the pairs. Phase containing mixture of monomers and dimers demonstrate a lower Weiss temperature of -11 K. The C<sub>70</sub><sup>•-</sup> radical anions form singly bonded (C<sub>70</sub><sup>•-</sup>)<sub>2</sub> dimers in **2**. The astrophloxine dye absorbs light in the visible range with maxima at 516 and 553 nm, and these bands are red-shifted to 530 and 556 nm. Low-energy absorption at about 3300 cm<sup>-1</sup> manifested by salt **1** is attributed to charge transfer within the  $\pi$ -stacking pairs [1].

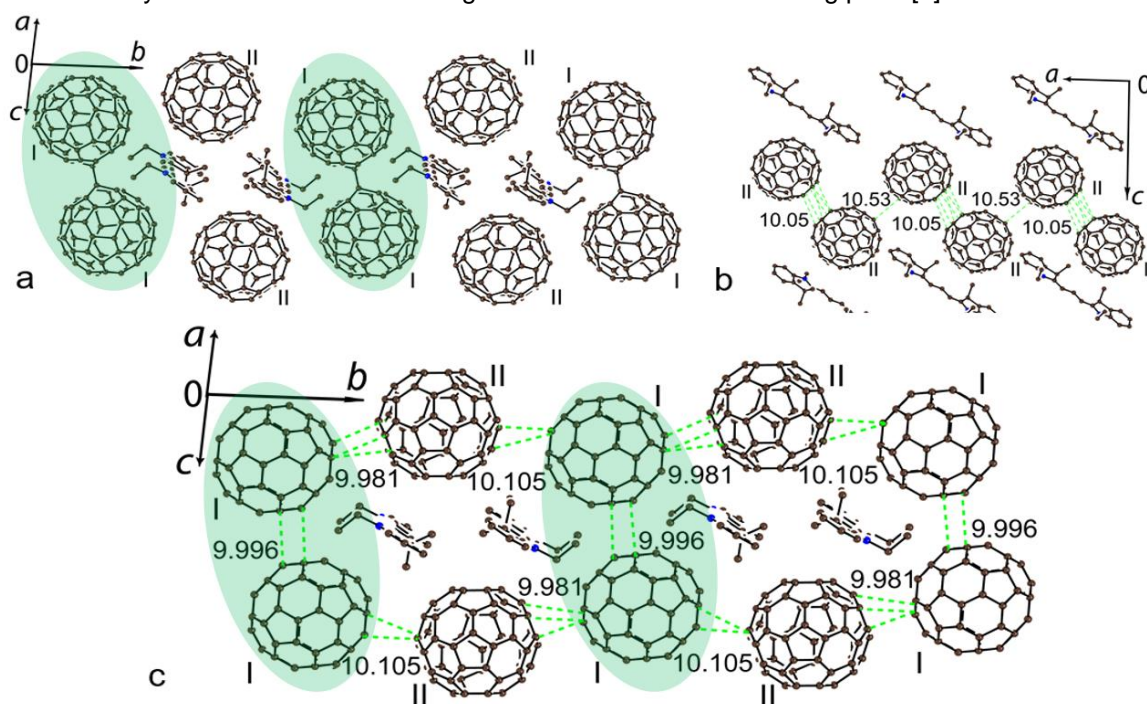

**Scheme 1.** Views on the packing of C<sub>60</sub><sup>•-</sup>, singly bonded (C<sub>60</sub><sup>•-</sup>)<sub>2</sub> dimers and the astrophloxine cations in (astrophloxine<sup>+</sup>)<sub>4</sub>(C<sub>60</sub><sup>•-</sup>)<sub>2</sub>(C<sub>60</sub><sup>-</sup>)<sub>2</sub> (**1**) at 103(1) K: at the positions for type I C<sub>60</sub> molecules (a) depicts dimeric (C<sub>60</sub><sup>•-</sup>)<sub>2</sub> with the 0.58 occupancy and (c) shows monomeric C<sub>60</sub><sup>•-</sup>s with the 0.42 occupancy; (b) the chains formed by the C<sub>60</sub><sup>•-</sup> pairs of type II.

## References

[1] *New J. Chem.* **2024**, Advance Article

## Acknowledgements

This work was financially supported by the Russian Science Foundation №24-13-00060.

DETERMINATION OF FLUOROQUINOL ANTIBIOTICS (NORFLOXACIN, OFLOXACIN, CIPROFLOXACIN) IN BLOOD SAMPLES BY UV SPECTROSCOPY

*Sokolova L.I., Chudovskaia E.M., Kolycheva V.B.*

Far Eastern Federal University, FEFU, Russky Island, Vladivostok, Russia

[sokolova.li@dvfu.ru](mailto:sokolova.li@dvfu.ru)

Fluoroquinolone antibiotics being effective drugs of a new generation are successfully applied to prevent and treat a range of microbial infections in surgical and medical treatment practice. In addition to medicine this group of antibiotics is used as farm animal feed premixes in veterinary.

A method for determining fluoroquinolone antibiotics (norfloxacin, ofloxacin, ciprofloxacin) in blood samples by UV spectrophotometry has been proposed.

Pig blood being similar in biochemical properties to human blood was taken as a model system.

The following absorption maximums of antibiotic solutions were found: 270nm for ciprofloxacin, 287nm for ofloxacin and 272nm for norfloxacin.

A sorbent based on natural zeolite from the Chuguevsky deposit of Primorsky Krai was used to purify blood samples and plasma obtained.

Zeolite was pre-washed with ethanol until non-UV absorbing elutriations were obtained.

The degree of extraction of the studied antibiotics from blood was found by the spike-recovery studies, it amounted to:  $85 \pm 4\%$  for ciprofloxacin,  $74 \pm 4\%$  norfloxacin,  $71 \pm 3\%$  for ofloxacin.

The antibiotic content was measured by differential spectrophotometry; blood plasma was used as a comparison solution.

The range of detectable concentrations of antibiotics has been found; for all drugs under the study is 0.001–0.1 mg/ml.

## RECENT ADVANCES IN THE SYNTHESIS AND FUNCTIONALIZATION OF 4-AZIDOFUROXANES TOWARDS 1,2,3-TRIAZOLES

Stebletsova I.A.<sup>1,2</sup>, Larin A.A.<sup>1</sup>, Fershtat L.L.<sup>1</sup><sup>1</sup> N.D. Zelinsky Institute of Organic Chemistry,<sup>2</sup> Mendeleev University of Chemical Technology of Russia

Student, laboratory assistant

[irinasteb@icloud.com](mailto:irinasteb@icloud.com)

Widely known that polyheterocyclic derivatives of 1,2,5-oxadiazole 2-oxide (furoxan) are highly enthalpy and thermally stable heterocycles with an increased content of nitrogen and oxygen in the structure, which allows them to be used as a valuable structural element for the design of promising high-energy materials of a new generation.

In order to improve the functional properties of these materials, it is often necessary to fine-tune their molecular structure. The combination of furoxan frameworks with fragments of 1,2,3-triazoles in one structure is a powerful tool for synthesis an optimal balance between the thermal stability of the target compound, its physicochemical characteristics and sensitivity to mechanical stress, which determine the possibilities of practical application of the material.

In this work, simple and effective modifications of 4-azidofuroxans were proposed for the assembly of the 4- and 5-nitro-1,2,3-triazole fragment, as well as the 5-amino-4-cyano-1,2,3-triazole. It is believed that the described transformation proceeds through an eliminative azide-olefin cycloaddition, leading to its complete regioselectivity. The proposed protocol allows the introduction of a wide substrate range into the reaction and makes it easy to assemble the 1,2,3-triazole motif on both furoxan and other heteroaromatic substrates. Also in this work, a new unusual chemical reaction was discovered, where in the presence of monovalent copper the C—C bond of the ethyl fragment of the amine base DIPEA is broken (scheme 1).

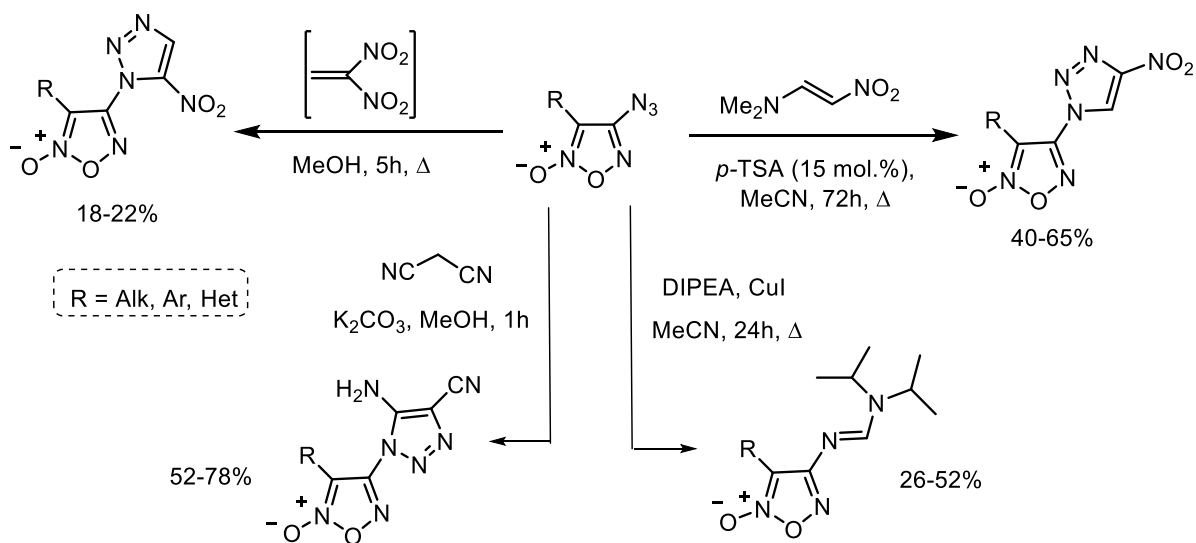

**Scheme 1.** Plausible synthetic ways to heterocyclization of 4-azidofuroxans.

### Acknowledgements

This work was supported by the Russian Science Foundation (project No 19-73-20074).

## RESEARCH OF DIHYDROQUERCETIN ISOMERIZATION BY POLARIMETRY

Terekhov R.P., Savina A.D., Pankov D.I., Selivanova I.A.

<sup>1</sup> Sechenov First Moscow State Medical University, Moscow, Russia

Associate professor, PhD

[terekhov\\_r\\_p@staff.sechenov.ru](mailto:terekhov_r_p@staff.sechenov.ru)

Dihydroquercetin (DHQ) is a natural chiral flavonoid compound (Fig. 1). The structure of this compound is characterized by two chiral centers in positions 2 and 3 of benzopyran cycle, which results in possible diastereomers: *trans*- and *cis*-isomer [1]. (2*R*,3*R*)-DHQ is registered as an active pharmaceutical ingredient in Russia, and other stereoisomers may be classified as biologically active impurities [2].

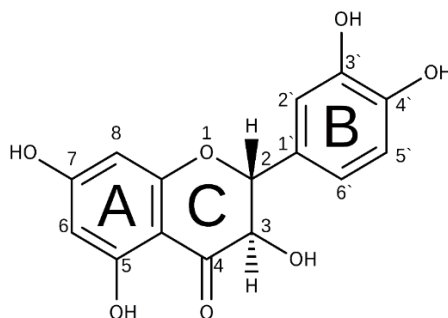

**Figure 1.** The progress of the increase in  $[\alpha_D^{20}]$  of DHQ water-alcohol solutions (1:1, vol.) at different concentrations of alkali and flavonoid.

DHQ has shown isomerization ability in water-alcohol solutions, which was associated with an increase in the specific angle of optical rotation value ( $[\alpha_D^{20}]$ ). This was discovered using an automatic digital polarimeter UniPol 2020 (Schmidt + Haensch, Berlin, Germany). The addition of alkali resulted in intensification of chemical reaction rate. The diastereoisomerization did not occur without water. The increase in  $[\alpha_D^{20}]$  followed the linear relationship equation and then steeped with a plateau (Fig. 2), which corresponds to zero order reaction.

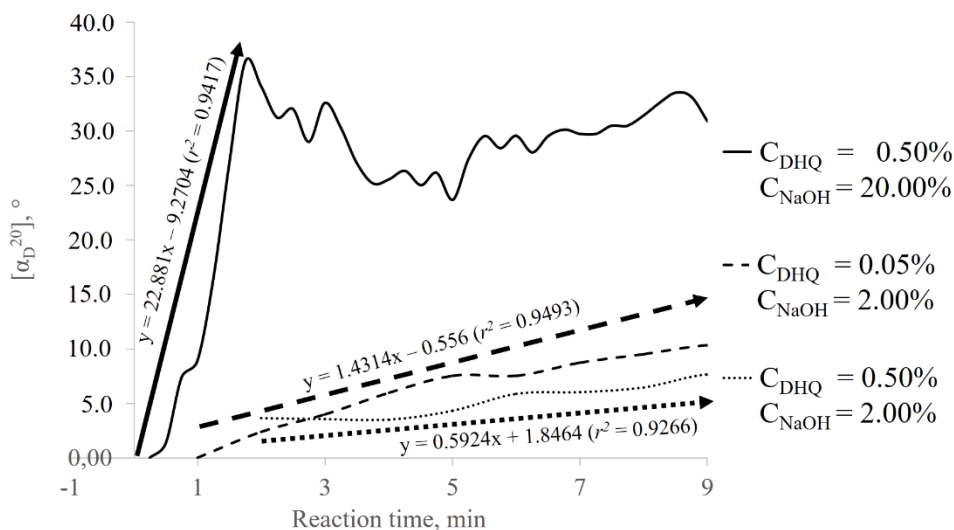

**Figure 2.** The progress of the increase in  $[\alpha_D^{20}]$  of DHQ water-alcohol solutions (1:1, vol.) at different concentrations of alkali and flavonoid.

## References

- [1] *Sci. Pharm.* **2024**, 92(1), 5  
 [2] *Farmatsiya* **2024**, 73(2), 5-12

## Acknowledgements

This work was supported by the Russian Science Foundation (project No 23-75-01130).



## BIOHYBRID VASCULAR ENDOTHELIAL GROWTH FACTOR INHIBITORS

*Udalova V.E., Petrova A.L., Tennikova T.B., Guryanov I.A., Silonov S.A.*

St. Petersburg State University, St. Petersburg, Russia

Student

[st097760@student.spbu.ru](mailto:st097760@student.spbu.ru)

Vascular endothelial growth factor (VEGF) – is a protein that is the main regulator of angiogenesis in organisms. In case of pathological angiogenesis, uncontrolled expression of this protein is triggered, which leads to a number of diseases. In addition, pathological angiogenesis is often observed in the development of oncological diseases and contributes to the growth of tumors and their metastases [1-3].

A number of modern publications show that modified cells can be used as highly specific delivery systems for pharmaceuticals.

Our laboratory has proposed a method for the synthesis of biohybrids based on the strain-promoted azide-alkyne cycloaddition, which is carried out by the incorporation of an alkyne into a stressed cyclooctyne system.

To carry out this reaction, anti-VEGF peptide conjugates with dibenzocyclooctyne (DBCO) were first synthesized. N-azidoacetylmannosamine was used for cell surface modification. Thus, the obtained DBCO-peptide conjugate was used to create biohybrids by click-reaction (Scheme 1).

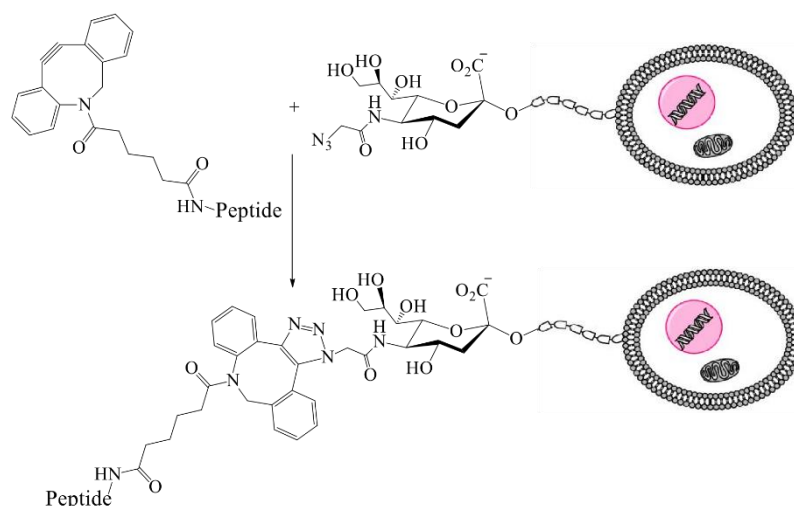

**Scheme 1.** Strategy for creating biohybrids.

In this study, we synthesized biohybrids based on VEGF-binding peptides Aib2 (VUPNc[CDIHV<sup>n</sup>LWEWEC]FERL-NH<sub>2</sub>), kv114\* (KUKKc[CDIHV<sup>n</sup>LWEWEC]FERL-NH<sub>2</sub>) and v114\* (VEPNc[CDIHV<sup>n</sup>LWEWEC]FERL-NH<sub>2</sub>). The antiproliferative effect of biohybrids was evaluated using an MTT test with human lung adenocarcinoma cells (A549), a human embryonic kidney cell line (HEK-293) was used as a control cell line.

### References

- [1] *Nat. Med.* **2003**, 9(6), 653–660
- [2] *Ann. Pharmacother.* **2004**, 38, 1258–1264
- [3] *J. Med. Chem.* **2000**, 43, 2310–2323

### Acknowledgements

The study was performed with the financial support of the Megagrant of the Government of the Russian Federation: "Biohybrid technologies for modern medicine" No. 14.W03.31.0025.

SYNTHESIS OF ASYMMETRIC TRI-*p*-TOLYLANTIMONY DICARBOXYLATES BY THE TRANSACYLATION REACTION*Vakhitov V.R.*<sup>1</sup>, *Gushchin A.V.*<sup>1</sup><sup>1</sup> Lobachevsky State University of Nizhny Novgorod, Nizhny Novgorod, Russia

Student

[cj2001@mail.ru](mailto:cj2001@mail.ru)

Triarylantimony dicarboxylates have been well studied in terms of their manifestation of antileishmanial activity, their use in organic synthesis in cross-coupling reactions and their use in polymerization to produce organometallic polymers [1]. There is very little information available in the scientific literature about asymmetric triarylantimony derivatives, despite their practical significance.

We have studied the possibility of obtaining compounds of the Ar<sub>3</sub>SbXY type (where X and Y are different carboxylate ligands) by the transacylation reaction. The presence of asymmetric tri-*p*-tolylantimony crotonate-chloroacetate in the mixture with the initial organometallic compounds was confirmed using NMR spectroscopy. Two products (in a 3:1 ratio) were detected by the interaction of "strong" dicarboxylate with weak acid, while the reaction between "weak" dicarboxylate and strong acid leads to three products (in a 2:3.5:1 ratio) in the resulting mixture.

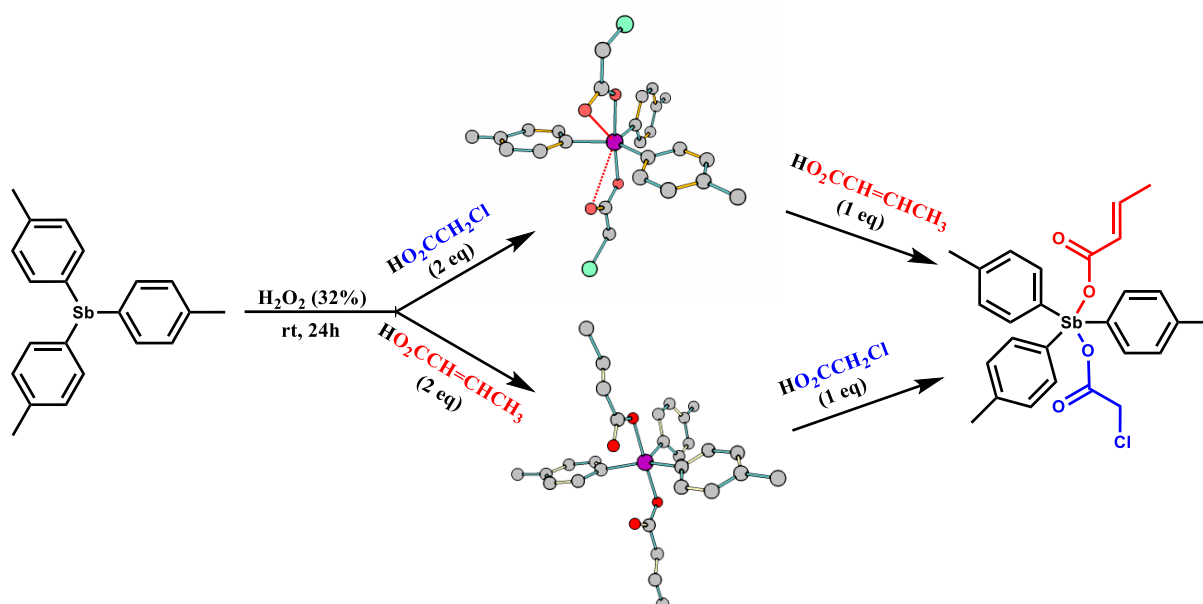

**Scheme 1.** Scheme of dicarboxylate synthesis with subsequent asymmetrization.

## References

[1] *Russ. J. Gen. Chem.* **2023**, 93, 292

## Acknowledgements

This work was financially supported by the Ministry of Education and Science of the Russian Federation in the framework of the basic part of the state contract (project no. FSWR-2023-0025)

## A NEW SYNTHETIC WAY FOR THE PREPARATION OF TEMPO DERIVATIVES

Valov N.R.<sup>1</sup>

<sup>1</sup> St. Petersburg State University, St. Petersburg, Russia  
 Bachelor  
[st075897@spbu.ru](mailto:st075897@spbu.ru)

TEMPO (2,2,6,6-tetramethylpiperidine-1-yl)-oxyl) is a stable aminoxyl radical capable of reversible redox reactions, which makes it possible to use TEMPO to create organic cathode materials. In the work [1], the possibility of creating organic batteries based on polymers modified by TEMPO was demonstrated. For a more detailed study of the relationship between the structure of TEMPO-modified polymers and their electrochemical properties in order to create materials with improved characteristics, it is necessary to develop a library of variously functionalized aminoxyl radicals, which poses the task of developing the synthesis of these compounds.

The research carried out includes the synthesis of new TEMPO derivatives potentially suitable for modification of conductive matrices. Thus, the **a-d** acids shown in Scheme 1 are potentially suitable for modification of carbon nanotubes, and oxime **e** and hydrazone **f** can be used to modify the graphene surface.

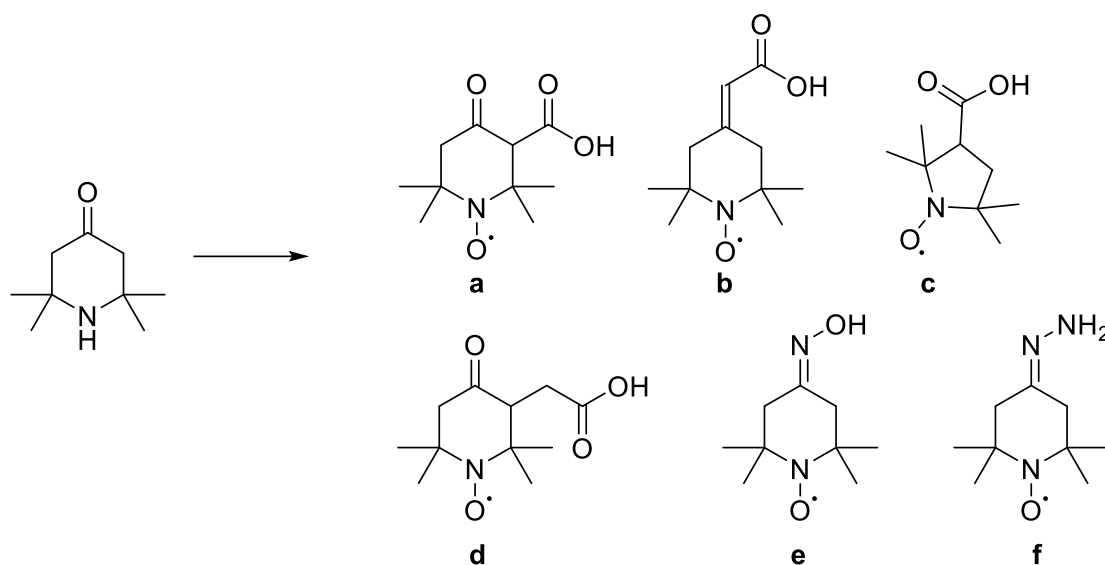

**Scheme 1.** A new TEMPO derivatives.

## References

[1] *Energies* **2022**, *15*(7), 915

## Acknowledgements

The work was supported by St Petersburg University, project 103921985 "Practice-oriented approach to the development of batteries based on organic materials".

## EPOXIDATION OF SUNFLOWER OIL USING AN INTERPHASE TRANSFER CATALYST

*Vasilyeva S.Y., Nasakin O.E., Koltsov N.I.*

I.N. Ulyanov Chuvash State University, Cheboksary, Russia  
[vasiljeva75@yandex.ru](mailto:vasiljeva75@yandex.ru)

Epoxidized vegetable oils (EVO) are an important renewable chemical raw material for the production of polymer composite materials. Usually, EVO are produced using the Prilezhaev reaction, which occurs by epoxidation of vegetable oils in the presence of percarboxylic acid formed in the presence of  $\text{H}_2\text{O}_2$  and  $\text{H}_2\text{SO}_4$  [1]. These reagents require special equipment and safety measures due to their corrosive and toxic nature. In addition, exothermic oxidation of percarboxylic acids makes it difficult to control temperature on an industrial scale and can lead to thermal release of the reaction mixture during production [2]. Moreover, the addition of inorganic acid as a co-catalyst to lower the pH leads to opening reactions of the formed epoxy groups, thereby limiting the selectivity of the reaction [3]. Therefore, there is a need to study safer, more economical and environmentally friendly production processes for the production of EVO. Hydrogen peroxide is an excellent oxidizer, which has received great attention in recent decades due to its non-toxic nature and low environmental impact [4]. In the oxidation of olefins, the weak oxidizing ability of hydrogen peroxide necessitates the search for catalysts with high performance [3]. Among the catalysts of the epoxidation process, peroxovolphram complexes are the most widely known [4]. Studies have shown that peroxolphram complexes are active for double bond epoxidation using hydrogen peroxide. To overcome the immiscibility of hydrogen peroxide with triglycerides, the active forms of peroxolphram complexes can be combined with cationic phase transfer agents [5]. This reaction system prevents the risk of overheating and provides higher selectivity and lower toxicity than the Prilezhaev system. However, such systems have been used to perform epoxidation of unsaturated compounds in organic solvents. It was of interest to test the process of epoxidation of vegetable oils in the absence of solvents.

In this regard, in this work, studies have been conducted on the epoxidation of sunflower oil with hydrogen peroxide in the presence of an interphase transfer catalyst, the role of which is played by benzyltriethanolammonium chloride.

The catalyst was obtained by mixing 50%  $\text{H}_2\text{O}_2$  with 1 mmol of phosphorous tungstic acid  $\text{H}_3\text{PW}_{12}\text{O}_{40} \cdot x\text{H}_2\text{O}$ , so that their ratio  $\text{H}_2\text{O}_2$ :  $\text{H}_3\text{PW}_{12}\text{O}_{40} \cdot x\text{H}_2\text{O}$  was equal to 12:1. The mixture was stirred for 1.5 hours at 40 °C. Then 3 mmol of benzyltriethanolammonium chloride was added in anhydrous ethanol and added to the mixture at room temperature, with constant stirring. In the resulting suspension solution, a white precipitate of the peroxolphram complex was isolated, the assumed structure of which is shown in **Scheme 1**.

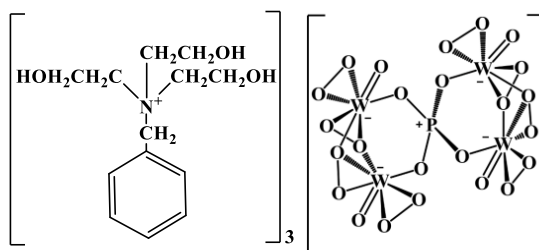

**Scheme 1.** The structure of the peroxovolphram complex.

The epoxidation process was carried out as follows: sunflower oil (30 g) was mixed with the resulting catalyst (0.3 g) and 50% hydrogen peroxide (12.24 g) was added drop by drop for 15 minutes while stirring for 4 hours. Studies of the iodine number and concentration of epoxy groups have shown that during the epoxidation reaction, the iodine number of epoxidated sunflower oil became 11.2 g/100g, and the concentration of epoxy groups was 10.1%.

### References

- [1] *Process Saf. Environ. Prot.* **2017**, 109, 529
- [2] *Process Saf Prog.* **2022**, 41:783
- [3] *Ind. Eng. Chem. Res.* **2018**, 57, 11517
- [4] *ChemSusChem* **2016**, 9, 3374
- [5] *J. Mol. Catal.* **1985**, 32, 107

## NEW POCOP-TYPE PINCER COMPLEXES WITH SIGMA-ALKYNYL LIGANDS: SYNTHESIS AND CHEMICAL PROPERTIES

Volkova D.S., Chudin O.S., Verpekin V.V.

Institute of Chemistry and Chemical Technology SB RAS, Krasnoyarsk, Russia

Graduate student

[2198vds@gmail.com](mailto:2198vds@gmail.com)

One of the general tasks of modern organometallic chemistry is the development of the compounds that can be applied in various fields of science and for practical using. In particular, such compounds are pincer complexes of transition metals exhibiting antitumor activity, and the complexes with sigma-alkynyl ligands exhibiting luminescent properties [1, 2]. However, compounds containing both types of the POCOP-type and sigma-alkynyl ligands are rare and poorly investigated.

Here we wish to report the results of studying methods for the synthesis of new POCOP<sup>Ph</sup>-type pincer complexes of Pt(II) and Ni(II) with sigma-alkynyl ligands (Scheme 1): (POCOP<sup>Ph</sup>)M-C≡C-R [M = Pt, R = COOMe (1), COOEt (2), CMe<sub>2</sub>OH (3), CPh<sub>2</sub>OH (4), CMePhOH (5); M = Ni, R = COOMe (6), COOEt (7), CMe<sub>2</sub>OH (8), CPh<sub>2</sub>OH (9), CMePhOH (10)], and the research of their chemical properties.

Platinum compounds 1-5 were synthesized by the Cu-catalyzed reaction of chloride pincer complex with corresponding acetylenes. At the same time, two alternative synthetic approaches have been explored to obtain complexes of nickel 6,7: Cu-catalyzed coupling and exchanging of a labile TFA-substituent at nickel atom of the initial compound (POCOP<sup>Ph</sup>)NiOC(O)CF<sub>3</sub>. It has been established that nickel complexes 8-10 can be obtained only by substitution reaction with the corresponding propargyl alcohol HC≡CC(OH)R<sup>1</sup>R<sup>2</sup>.

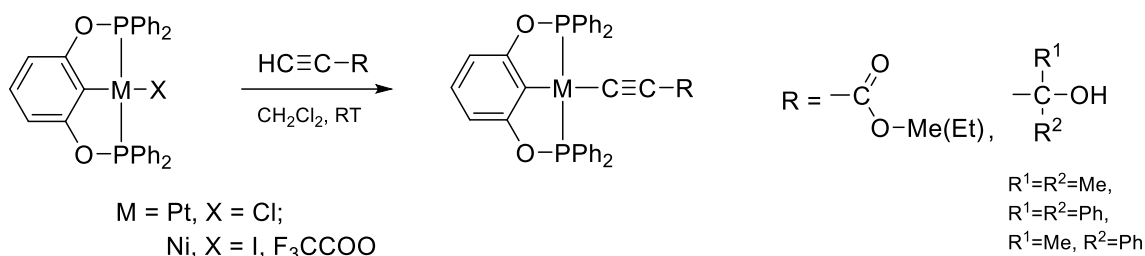

Reaction conditions	Initial reagents	t, h	Product	Yield, (%)
Cu-catalyzed coupling CuCl (0.3 eq.) + NEt <sub>3</sub> (2 eq.)	[Pt]-Cl	HC≡CCOOR	[Pt]-C≡CCOOR	R=Me (97) (1); R=Et (94) (2)
		HC≡CC(OH)R <sup>1</sup> R <sup>2</sup>	[Pt]-C≡CC(OH)R <sup>1</sup> R <sup>2</sup>	R <sup>1</sup> =R <sup>2</sup> =Me (86) (3); R <sup>1</sup> =R <sup>2</sup> =Ph (98) (4); R <sup>1</sup> =Me, R <sup>2</sup> =Ph (90) (5)
	[Ni]-I	HC≡CCOOR	[Ni]-C≡CCOOR	R=Me (97) (6); R=Et (90) (7)
		HC≡CC(OH)R <sup>1</sup> R <sup>2</sup>	<i>No reaction</i>	
Substitution of labile TFA substituent in the presence of NEt <sub>3</sub>	[Ni]-TFA	HC≡CCOOR	[Ni]-C≡CCOOR	R=Me (59) (6); R=Et (70) (7)
		HC≡CC(OH)R <sup>1</sup> R <sup>2</sup>	[Ni]-C≡CC(OH)R <sup>1</sup> R <sup>2</sup>	R <sup>1</sup> =R <sup>2</sup> =Me (95) (8); R <sup>1</sup> =R <sup>2</sup> =Ph (92) (9); R <sup>1</sup> =Me, R <sup>2</sup> =Ph (89) (10)

**Scheme 1.** Preparation of Pt(II) and Ni(II) POCOP<sup>Ph</sup>-type pincer complexes with sigma-alkynyl ligands.

The interaction of 1-10 with halide coordination compounds (Pd(CH<sub>3</sub>CN)<sub>2</sub>X<sub>2</sub> (X = Cl, Br), Pt(dmsO)<sub>2</sub>Cl<sub>2</sub>) has been studied. It has been established that in these reactions such Pt(II) and Ni(II) POCOP<sup>Ph</sup>-type pincer complexes with sigma-alkynyl ligands are exhibiting as transmetallic reagents.

## References

- [1] *Org. Biomol. Chem.* **2021**, 19, 5254-5273  
[2] *Angew. Chem. Int. Ed.* **2003**, 42, 2586-2617

## Acknowledgements

The study was conducted within the framework of the budget project FWES-2021-0012 Institute of Chemistry and Chemical Technology SB RAS using the equipment of Krasnoyarsk Regional Research Equipment Centre of SB RAS.

## SYNTHESIS OF NEW HETEROCYCLIC SYSTEMS: PYRIMIDO[4',5':4,5]FURO[2,3-c]-2,7-NAPHTHYRIDINES

*Yegoryan H.A.*<sup>1</sup>, *Yermalovyan L.V.*<sup>1</sup>, *Hakobyan E.K.*<sup>1</sup>, *Sirakanyan S.N.*<sup>1</sup>, *Geronikaki A.*<sup>2</sup>,  
*Hovakimyan A.A.*<sup>1</sup>

<sup>1</sup> Scientific Technological Center of Organic and Pharmaceutical Chemistry of National Academy of Sciences of Republic of Armenia, Institute of Fine Organic Chemistry

<sup>2</sup> Department of Pharmaceutical Chemistry, School of Pharmacy, Aristotle University, Thessaloniki, Greece

Yegoryan Hasmik, young scientist, master's degree

[hasmik.yegoryan@mail.ru](mailto:hasmik.yegoryan@mail.ru)

2,7-Naphthyridine derivatives are interesting compounds in the field of heterocyclic chemistry also due to their interesting biological activities, as evidenced by recent reviews [1, 2]. Our investigations revealed that bicyclic 1,3-dihydroxy-2,7-naphthyridines could show antiarrhythmic activity [3], while tricyclic pyrazolo[3,4-c]-2,7-naphthyridines [4] and triazolo[3,4-a]-, triazolo[5,1-a]-2,7-naphthyridines displayed high neurotropic activity [5]. Herein we report the synthesis of new tetracyclic heterocyclic systems: pyrimido[4',5':4,5]furo[2,3-c]-2,7-naphthyridines **4**. For the synthesis as starting compounds 1-amino-3-hydroxy-2,7-naphthyridines **1** [6] were used. Compounds **1** were alkylated by various alkyl halides under the basic conditions and the corresponding *O*-alkylated derivatives of 2,7-naphthyridine **2** were synthesized in high yields. In turn, the obtained alkoxyacetamides **2** were cyclized into aminoamides of furo[2,3-c]-2,7-naphthyridines **3** under the action of sodium ethoxide in ethanol. After compounds **3** by the cyclocondensation with triethyl orthoformate were converted into the aimed new heterocyclic systems: pyrimido[4',5':4,5]furo[2,3-c]-2,7-naphthyridines **4** (Scheme 1).

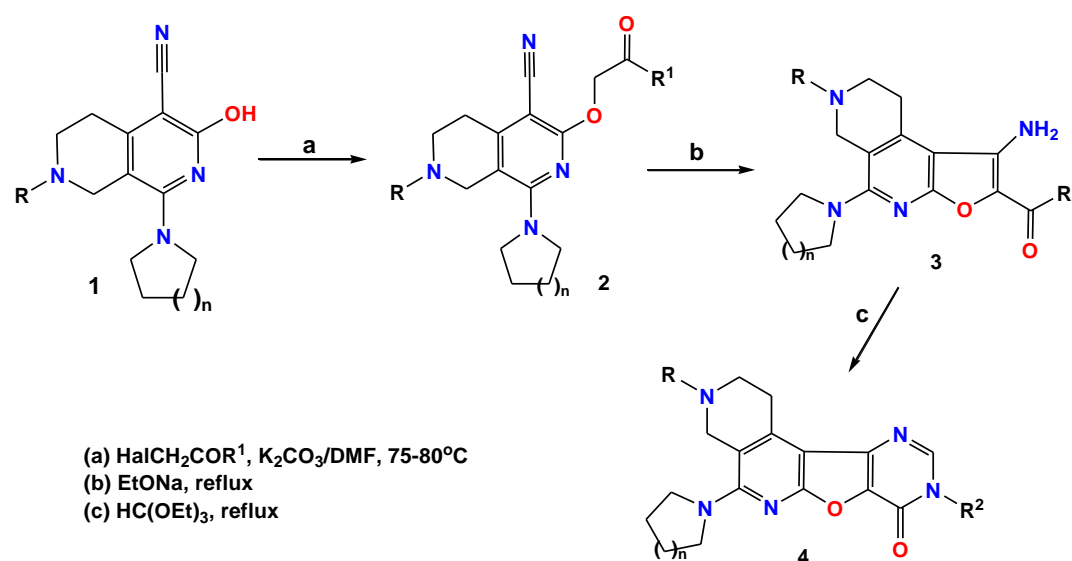

**1-4.** R = alkyl; n = 1–3; R<sup>1</sup> = OEt, amine; R<sup>2</sup> = H, aryl.

**Scheme 1.** Synthesis of new heterocyclic systems: pyrimido[4',5':4,5]furo[2,3-c]-2,7-naphthyridines **4**.

## References

- [1] *Curr. Org. Chem.* **2021**, 25, 2740  
 [2] *Adv. Heterocycl. Chem.* **2006**, 91, 189  
 [3] *Pharm. Chem. J.* **1996**, 30, 365  
 [4] *Pharm. Chem. J.* **2018**, 52, 108  
 [5] *Pharm. Chem. J.* **2014**, 48, 231  
 [6] *Inter. J. Mol. Sci.* **2022**, 23, 5904

## Acknowledgements

This work was supported by the Science Committee of RA, in the frames of the research project № 21AG-1D036.

## SYNTHESIS AND STUDY OF THE STRUCTURAL AND LUMINESCENT PROPERTIES OF KETOIMINES CONTAINING BENZOSELENODIAZOLE

P.R. Yunusova<sup>2</sup>, Ilya S. Ponomorev<sup>2</sup>, M. A. Lutoshkin<sup>1</sup><sup>1</sup> Institute of Chemistry and Chemical Technology SB RAS, Krasnoyarsk, Russia<sup>2</sup> Siberian Federal University, Krasnoyarsk, Russia

Student

[il.p0nomarew@yandex.ru](mailto:il.p0nomarew@yandex.ru)  
[yunusova.paulina@yandex.ru](mailto:yunusova.paulina@yandex.ru)

The study of various derivatives of 2,1,3-benzohalcoygenediazoles and betadiketonate esters, including, for example, ethoxy-3-oxobutanoate, is of considerable scientific interest for the creation of polydentate ligands with various coordination centers. Due to their electronic properties, these compounds have the potential for application in various fields, including the development of luminescent materials [1], active components for biological systems [2] and catalysts [3].

Therefore, the main purpose of this study is to develop effective methods for the synthesis of ketones containing benzoselenodiazole and to study their luminescent properties.

The following method was used to synthesize substituted benzodiazole using selenium. The initial stage was the cyclization reaction of diaminobenzene with selenium (IV) oxide, followed by nitration and subsequent reduction of the resulting product. The resulting triaminobenzene was then reused in a cyclization reaction with selenium (IV) oxide. The resulting 4-amino-2,1,3-benzoselenediazole was introduced into a condensation reaction with substituted acetoacetic ether, forming ketoimines. Previously unknown ketoimines containing selenodiazole were analyzed by NMR spectroscopy and mass spectrometry.

Compounds:

(Z)-ethyl 3-(benzo[c][1,2,5]selenodiazole-4-ylamino)-3-(p-tolyl)acrylate: NMR<sup>1</sup>H(CHCl<sub>3</sub>, 600 MHz): 8.50 c. (H, NH), 8.26 d. (2H, Ph), 7.97 d. (2H, Ph) 7.75 m.(H, BTD), 7.54 m.(H, BTD), 7.40(H, BTD), 5.69c. (H, CH), 4.18 d.(2H, CH<sub>2</sub>), 1.22 m.(3H, CH<sub>3</sub>); Agilent 7000A (HP-5ms): 418.02 (100.0%), 416.02 (50.9%), 420.02 (20.2%), 419.02 (20.1%), 415.02 (19.1%), 414.02 (18.8%); Yield 90%.

(Z)-ethyl-3-(benzo[c][1,2,5]selenodiazole-4-ylamino)-3-(4-nitrophenyl)acrylate: NMR<sup>1</sup>H (CHCl<sub>3</sub>, 600 MHz): 8.32 c. (H, NH), 7.79 m.(H, BTD), 7.46 m.(2H, Ph) 7.40 m.(H, BTD), 7.16 m.(2H, Ph), 5.65 c. (H, CH), 4.18 m.(2H, CH<sub>2</sub>), 2.31 c.(3H, CH<sub>3</sub>,Ph), 1.25 m.(3H, CH<sub>3</sub>); Agilent 7000A (HP-5ms): 387.05 (100.0%), 385.05 (48.0%), 388.05 (20.8%), 384.05 (19.2%), 383.05 (18.8%), 389.05 (18.2%), 386.05 (9.9%); Yield 92%.

It was found that the maxima of the luminescence spectra of aminosubstituted selenodiazole were shifted to the blue region by 100 nm relative to the initial ligand (Fig. 2. a- benzothiadiazole, b- benzoselenodiazole).

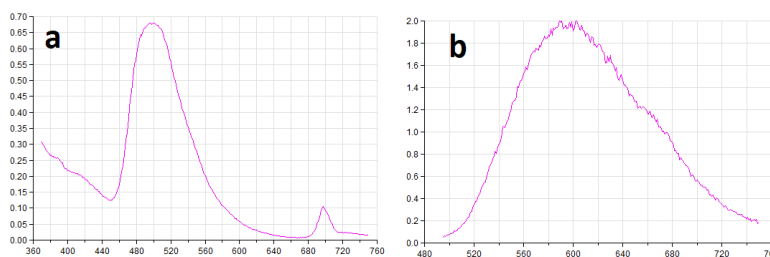

**Scheme 1.** Luminescence spectra of a-benzothiadiazole and b-benzoselenodiazole.

## References

- [1] *J. Mater. Chem. C*, **2018**, *6*, 1731-1737  
 [2] *Synthesis.*, **2006**, *23*, 3945-3947. *Inorg.Chimica Acta*, **2022**, *538*, 120973  
 [3] *Org. Lett.* **2019**, *21*, 18, 7213–7217

ADSORPTION OF A CHEMICAL IRRITANT, PYRIDINE ON A METAL-ORGANIC FRAMEWORK  
NiABDC

*Zaitseva Y.M.<sup>1</sup>, Mushatakov A.G.<sup>1</sup>, Smirnova S.S.<sup>1</sup>, Anistratov N.A.<sup>1</sup>, Selivanova M.M.<sup>1</sup>, Markova E.B.<sup>1</sup>*

<sup>1</sup> Peoples' Friendship University of Russia (RUDN), Moscow, Russia

Student

[yuliazaytseva22@gmail.com](mailto:yuliazaytseva22@gmail.com)

If the pyridine gets on the skin, there are signs of irritation: redness, increased skin temperature and thickness of the skin fold, when inhaling pyridine vapors, there is an effect on the central nervous system, up to clouding of consciousness [1]. For these reasons, it is necessary to develop low-toxic sorbents, which can be represented by Metal-Organic Frameworks (MOFs) – materials consisting of inorganic clusters of metals bounding to bridging organic ligand molecules. The practical application of MOFs is often motivated by their ultrahigh porosity [2].

In this study we obtained by solvothermal synthesis method a metal-organic framework based on nickel ions and linker of 2-aminoterephthalic acid ( $C_6H_3NH_2(COOH)_2$ ) – NiABDC.

The NiABDC sample has a crystalline structure, but it has not been described in the literature yet, so we calculated the cell parameters of this compound using FOX software [3]. (Table 1).

**Table 1.** Parameters of the unit cell of the NiABDC sample with indication of the profile ( $R_p$ ) and weight ( $R_w$ ) R-factors.

a, Å	b, Å	c, Å	$\alpha^\circ$	$\beta^\circ$	$\gamma^\circ$	$R_p, \%$	$R_w, \%$
9.99	10.99	11.99	95.77	101.47	107.16	1.70	1.42

An experiment on the absorption of pyridine was performed using adsorption spectroscopy (fig. 1a).

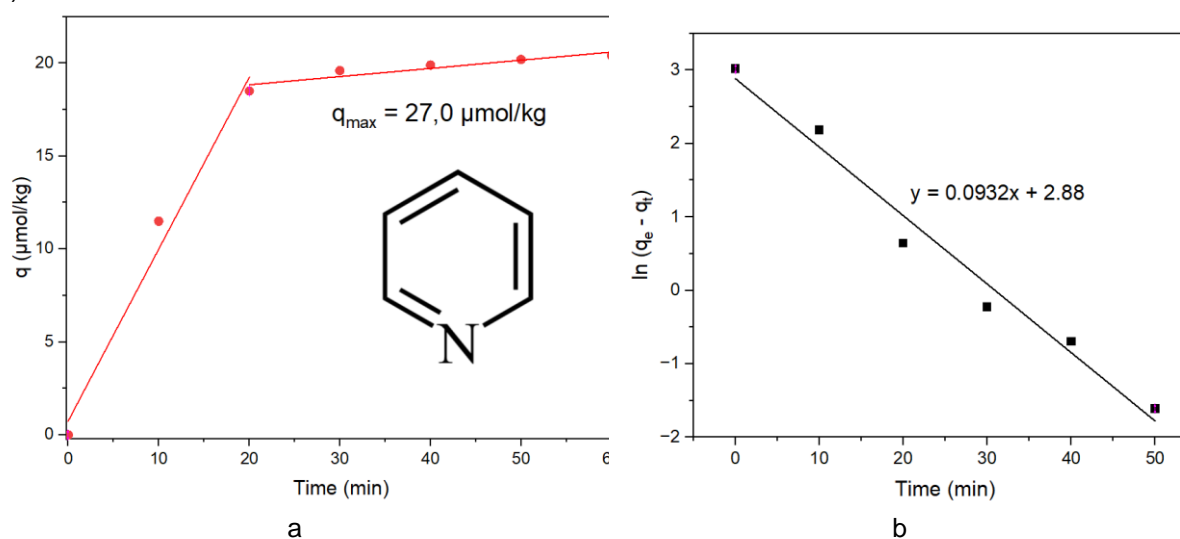

**Figure 1.** Pyridine's adsorption isotherm (a). The schedule for determining the reaction order (b).

The maximum adsorption was  $27.0 \mu\text{mol/kg}$ . According to kinetic calculations, the adsorption process obeys a pseudo-first order equation. The reaction rate constant calculated from the graph was  $0.093 \text{ min}^{-1}$  (1b).

In conclusion, we can mention, that the maximum adsorption value was  $27 \mu\text{mol/kg}$  we have adsorbed the chemical irritant pyridine on NiABDC, the graph shows that the process of fast and slow adsorption takes place, which means that pyridine is sorbed on two types of adsorption centers.

#### References

- [1] *Chemosphere* **1998**, 36, 2345  
 [2] *Chem. Rev.* **2021**, 121, 12278  
 [3] *J. Appl. Cryst. International Union of Crystallography* **2002**, 35, 734

#### Acknowledgements

The PXRD was supported by equipment of the RTU MIREA Central Research Center, which received the support of the Ministry of Science and Higher Education of the Russian Federation under the Agreement No. 075-15-2021-689 dated 09/01/2021.



## COMPARISON OF THE METHODS OF TRITERPENIC ACIDS EXTRACTION FROM SIBERIAN FIR

*Zakharkiva A.M.*<sup>1</sup>, *Kazantseva K.I.*<sup>1</sup>, *Kurzina I.A.*<sup>1</sup>

<sup>1</sup> Tomsk State University, Tomsk, Russia

PhD Student

[alex.zakharkiva@gmail.com](mailto:alex.zakharkiva@gmail.com)

Conifers, including *Abies sibirica* Ldb. (Siberian fir), are known as a large reservoir of biologically active substances, in particular terpenoids [1], as well as carotenoids, fatty acids and their derivatives, triterpenic acids (TTAs), phenolic compounds, vitamins, etc. Coniferous extracts are used in medicine when treating the respiratory system diseases (bronchitis, laryngitis, influenza); musculoskeletal system diseases (rheumatism, gout, arthritis); genitourinary system diseases (cystitis, prostate gland inflammation); skin diseases (eczema, psoriasis, inflammatory and neurohumoral rash) and in agriculture owing to their fungicidal, bactericidal and growth-promotion properties. Intensification of technological processes aimed at isolating extractive substances, integrated approach to raw material processing, application of new technologies, and detailed study of chemical composition and biological activity contribute all together to the expansion of the range of obtained products.

This work considers the methods of obtaining the samples based on plant extracts from the wood greens of Siberian fir conifers containing triterpenic acids as a main active ingredient and other related biologically active substances, the scheme of obtaining is presented (1). A method of the determination of the quantitative composition of the samples by high-performance liquid chromatography using the mass-spectrometric detection (HPLC-MS) of TTAs was developed.

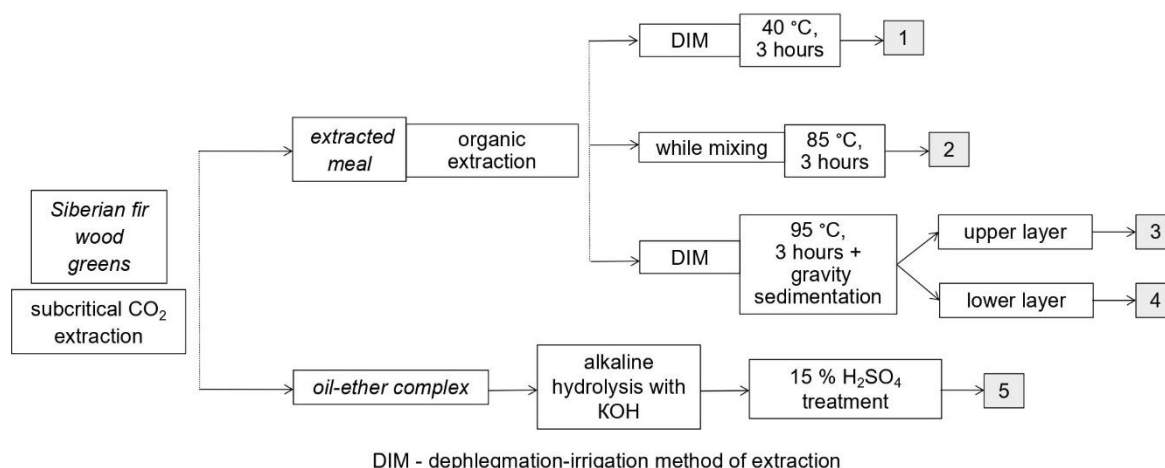

**Scheme 1.** Methods of obtaining the coniferous extracts containing TTAs.

The separation of triterpenic acids was carried out using the high-performance liquid chromatography with mass spectrometric detection (HPLC-MS) in the HILIC mode. Sample preparation included liquid extraction with ultrasonic processing, followed by filtration through PTFE syringe filters. The assessment of the total content of triterpenic acids was conducted using the external standard method. As an external standard, 3-hydroxy-23-oxolanostane acid was chosen. The content of triterpenic acids in the obtained samples was 44, 12, 67, 1 and 64 wt.%, respectively, for samples No. 1-5.

## References

[1] *Plant Journal* **2008**, 656–659

## Acknowledgements

The work was supported by the Federal project "Schools of Advanced Engineering Studies"/



# **ADVANCES IN COORDINATION AND INORGANIC CHEMISTRY**



# **KEYNOTE & INVITED SPEAKERS**



## KEYNOTE SPEAKER



**Dr. Sci., Prof. Irina Goryacheva**

*Head of the Department of General and Inorganic Chemistry,  
Director of the Institute of Chemistry, Saratov State University,  
Saratov, Russia*

**Semiconductor Quantum Dots for Bioanalysis**

## INVITED SPEAKERS

**Dr., Prof. Jefferson L. Ferrari**

*Institute of Chemistry, Federal University of Uberlândia,  
Uberlândia, Brazil*

**The Conversion of Energy into Inorganic Materials  
Containing Rare Earths for Possible Use in  
Photodynamic Therapy**



**Dr. Sci., Assoc. Prof. Andrey Mereshchenko**

*St Petersburg University, St. Petersburg, Russia*

**Luminescent Heterometallic Rare Earth Based  
Terephthalate MOFs**

## SEMICONDUCTOR QUANTUM DOTS FOR BIOANALYSIS

Goryacheva I.Y.

Saratov State University, Saratov, Russia  
Dr. Sci., Prof., Head of the Department of General and Inorganic Chemistry  
[goryachevaiy@mail.ru](mailto:goryachevaiy@mail.ru)

Quantum dots (QDs) are semiconductor nanoparticles with optical and electronic properties that differ from bulk semiconductor. Quantum dots have been widely used in solar cells, photovoltaic devices, light-emitting diodes, displays, photocatalytic processes and as photoluminescent label for biomedical research. Small size, photo- and colloidal stability, bright turnable emission, high surface area and possibility to create desired design give prospects of wide QD application in bioanalysis as labels and nanosensors. The toxicity of the starting materials, multistage character, and laboriousness of some approaches to the synthesis of QDs are the main difficulties in the application of QDs.

Despite considerable difficulties with the synthesis and hydrophilization, labels on the basis of semiconductor QDs are required in fluorescence analysis and visualization because of their high resistance to photobleaching and a possibility of the simultaneous excitation of several QDs by virtually any light source. Therefore, QDs development for application in chemical analysis is of special interest, and the detailed consideration of the factors affecting QD properties and also of particular stages of their synthesis and features of their use is required.

Luminescent QDs can be applied in two modes: as passive labels, usually conjugated with natural or artificial receptors or as active nanosensors. While for the label the high quantum yield, narrow emission spectrum and colloidal stability are the most important properties, for nanosensors sensitivity for analyte presence in microenvironment become the key property.

The presentation covers the main approaches to the synthesis, modification, and use of luminescence QDs in chemical analysis [1, 2]. Approaches to the sensitization and multiplicity of analysis and tools for regulating selectivity based on both the properties of QDs and, in addition, the receptors used are also described [3, 4].

### References

- [1] *J. Anal. Chem.* **2021**, 76, 273
- [2] *J. Anal. Chem.* **2022**, 77, 402
- [3] *Trends Anal. Chem.* **2020**, 127, 115897
- [4] *Trends Anal. Chem.* **2019**, 111, 197

### Acknowledgements

This work was supported by the Russian Science Foundation (project No 23-13-00380).

THE CONVERSION OF ENERGY INTO INORGANIC MATERIALS CONTAINING RARE EARTHS  
FOR POSSIBLE USE IN PHOTODYNAMIC THERAPYFerrari J.L.<sup>1</sup> Institute of Chemistry, Uberlândia Federal University, Av. João Naves de Avila, Uberlândia – Minas Gerais – Brazil, Development of Inorganic Materials with Rare Earths Laboratory - (DeMITer)[jeffersonferrari@ufu.br](mailto:jeffersonferrari@ufu.br) and [jeffersonferrari@gmail.com](mailto:jeffersonferrari@gmail.com)

The use of photodynamic therapy (PDT) is an alternative in combating many types of cancer, both as a therapeutic method and in diagnosis. PDT requires a sensitizing agent that binds tightly by chemical bonds to cells. By absorbing a specific wavelength, the sensitizing agent allows the transformation of triplet molecular oxygen ( $^3\text{O}_2$ ) to singlet molecular oxygen ( $^1\text{O}_2$ ). The presence of  $^1\text{O}_2$  in biological systems can cause cell death through apoptosis. One of the needs of having an effective sensitizing agent is its physical and chemical properties such as a crystalline structure that allows excellent light absorption, spectroscopic property that allows an improvement in quantum efficiency, electronic band structure, so that the sensitizer presents a band gap of higher energy than the emission energy so that there is no self-absorption. Another important point is the characteristic of absorbing light in the near infrared region, around 980 nm, and emitting it in the green or red region. One of the ways to achieve this is the use of inorganic materials containing Rare Earths that allow the upconversion phenomenon to appear. The red emission can contribute to the therapy of the disease locally and the green emission to obtain the image, for example, of the cell in which the sensitizer is chemically bound. The absorption of radiation at 980 nm by the material is very interesting because in this region the absorption by biological tissue is very low. Consequently, the penetration of radiation into biological tissue is greater, activating the photosensitizing material in a further location and within the cell. In most commercially used sensitizers, the excited state lifetime is on the order of nanoseconds. The molecules to which these sensitizers are chemically linked often exhibit photoluminescence and excited state lifetimes on the order of ns. Therefore, when generating the image, the emission of light from the sensitizer and the chemically labeled molecule are superimposed, generating an accumulation of signal from different sources, resulting in a low resolution of the generated image, often making more accurate diagnoses difficult. Therefore, this presentation aims to show some possible inorganic materials containing Rare Earths that can act in photodynamic therapy, trying to solve some problems observed to this day.

**References**

- [1] *Front. Chem.* **2022**, *10*, 1  
[2] *Progress in Optical Science and Photonics*, Springer-Nature **2013**, *24*, 369

**Acknowledgements**

This work was supported by the FAPEMIG, CAPES, CNPq and FINEP.

## LUMINESCENT HETEROMETALLIC RARE EARTH BASED TEREPHTHALATE MOFS

*Mereshchenko A.S., Butorlin O.S., Petrova A.S., Toikka Yu.N., Badikov A.R., Bogachev N.A., Skripkin M.Yu.*

St. Petersburg State University, St. Petersburg, Russia  
[a.mereshchenko@spbu.ru](mailto:a.mereshchenko@spbu.ru)

The effect of the joint presence of two rare earth ions on the optical properties in metal-organic frameworks (MOFs) possessing antenna effect will be discussed in this presentation [1-3]. The series of  $(M_xLn_{1-x})_2\text{bdc}_3 \cdot n\text{H}_2\text{O}$  heterometallic terephthalate MOFs ( $M = \text{Eu, Tb}$ ;  $Ln = \text{Lu, La, Gd, Y}$ ;  $x = 0-1$ ) were synthesized in the aqueous solution by the mixing of the  $\text{EuCl}_3/\text{TbCl}_3$  and  $\text{LnCl}_3$  taken in stoichiometric ratios with the excess of  $\text{Na}_2\text{bdc}$  ( $\text{bdc}^{2-} = 1,4\text{-benzene-1,4-dicarboxylic (terephthalate) ion}$ ). For the  $(M_xLn_{1-x})_2\text{bdc}_3 \cdot n\text{H}_2\text{O}$  ( $M = \text{Eu, Tb}$ ;  $Ln = \text{La, Gd, Y}$ ) series, we have found the formation of terephthalates tetrahydrates  $(M_xLn_{1-x})_2\text{bdc}_3 \cdot 4\text{H}_2\text{O}$  corresponding to the crystalline phase  $\text{Ln}_2(1,4\text{-bdc})_3 \cdot 4\text{H}_2\text{O}$  ( $Ln = \text{Ce-Yb}$ ) [4]. On the other hand, the crystalline phase of Lu-containing MOFs  $(M_x\text{Lu}_{1-x})_2\text{bdc}_3 \cdot 4\text{H}_2\text{O}$  ( $M = \text{Eu, Tb}$ ) depends on the lutetium content. At the lutetium concentration less than 70 at. % a single crystalline phase is formed,  $(M_x\text{Lu}_{1-x})_2\text{bdc}_3 \cdot 4\text{H}_2\text{O}$  ( $M = \text{Eu, Tb}$ ). At Lu content higher than 70 at. %, the numerous crystalline phases are formed depending on Lu content and the concentration of initial solutions,  $(M_x\text{Lu}_{1-x})_2\text{bdc}_3 \cdot n\text{H}_2\text{O}$  ( $n = 0, 2.5, 10$ ). All the synthesized samples containing  $\text{Eu(III)}$  demonstrate bright red emission corresponding to  ${}^5\text{D}_0 \rightarrow {}^7\text{F}_J$  ( $J = 0-4$ ) transitions of  $\text{Eu}^{3+}$  ion upon the 300-nm excitation into  ${}^1\pi\pi^*$  excited state of terephthalate ion. All the synthesized samples containing  $\text{Tb(III)}$  demonstrate bright green emission corresponding to  ${}^5\text{D}_4 \rightarrow {}^7\text{F}_J$  ( $J = 3-6$ ) transitions of  $\text{Tb}^{3+}$  ion upon the 300-nm excitation into  ${}^1\pi\pi^*$  excited state of terephthalate ion. For  $(M_x\text{Lu}_{1-x})_2\text{bdc}_3 \cdot n\text{H}_2\text{O}$  series luminescent properties significantly depend on the crystalline phase: excited state lifetimes of  $\text{Eu}^{3+}$  and  $\text{Tb}^{3+}$  are larger in  $\text{Ln}_2\text{bdc}_3$  crystalline phase than the corresponding values for  $\text{Eu}^{3+}$  and  $\text{Tb}^{3+}$  in  $\text{Ln}_2\text{bdc}_3 \cdot 4\text{H}_2\text{O}$ ,  $\text{Ln}_2\text{bdc}_3 \cdot 2.5\text{H}_2\text{O}$ , and  $\text{Ln}_2\text{bdc}_3 \cdot 10\text{H}_2\text{O}$  due to efficient luminescence quenching of  $\text{Eu}^{3+}/\text{Tb}^{3+}$  by coordinated water molecules in  $\text{Ln}_2\text{bdc}_3 \cdot n\text{H}_2\text{O}$  phases. In  $(M_x\text{Ln}_{1-x})_2\text{bdc}_3 \cdot 4\text{H}_2\text{O}$  ( $M = \text{Eu, Tb}$ ;  $Ln = \text{La, Gd, Y}$ ) series, photoluminescence quantum yields and excited state lifetimes in a much smaller degree depend on the concentration of optically-inert rare-earth ions ( $\text{La, Gd, Y}$ ). The substitution of  $\text{Eu}^{3+}$  and  $\text{Tb}^{3+}$  ions for  $\text{La}^{3+}$  or  $\text{Y}^{3+}$  do not affect optical properties until very high concentrations of these ions, whereas  $\text{Gd}^{3+}$  doping increases photoluminescence quantum yield upto 1.5 times.

## References

- [1] *Molecules* **2024**, *29*, 532  
 [2] *Molecules* **2023**, *28*, 2378  
 [3] *Molecules* **2022**, *27*, 5763  
 [4] *J. Am. Chem. Soc.* 1999, *121*, 1651

## Acknowledgements

This work was supported by the Russian Science Foundation (project No 22-73-10040 <https://rscf.ru/en/project/22-73-10040/>). The measurements were performed at the Research Park of Saint-Petersburg State University (“Magnetic Resonance Research Centre”, “SPbU Computing Centre”, “Cryogenic Department”, “Interdisciplinary Resource Centre for Nanotechnology”, “Centre for X-ray Diffraction Studies”, “Chemical Analysis and Materials Research Centre”, and “Centre for Optical and Laser Materials Research”).



# **ORAL & POSTER PRESENTATIONS**



# BIPYRIDINE-BASED PHOSPHINE OXIDES AS ANCILLARY LIGANDS FOR BIS-CYCLOMETALLATED IRIDIUM(III) COMPLEXES

*Abramova E.O.*<sup>1</sup>, *Grachova E.V.*<sup>1</sup>

<sup>1</sup> St Petersburg University, St. Petersburg, Russia

Young researcher

[st062014@student.spbu.ru](mailto:st062014@student.spbu.ru)

Usually, intramolecular charge transfer can be realized in organic compounds carrying a donor and an acceptor groups, which are connected to each other via pi-conjugated linker. Such compounds are known as 'push-pull chromophores' or 'donor- $\pi$ -linker-acceptor' ('D- $\pi$ -A') systems. Due to their properties, they find wide applications in fields related to energy conversion, in particular in optoelectronics or photovoltaics [1]. Such systems can also be used as ligands for transition metal complexes, which can lead to interesting photophysical properties of the organometallic luminophore [2].

Nowadays, cyclometallated iridium(III) complexes are widely studied due to their potential applications as phosphorescent materials for OLED devices. It is known that the diphenylphosphine oxide group can improve the electron injecting and transporting capabilities, which makes it attractive for modification of Ir(III) luminophores in host materials [3].

Herein we report the synthesis of two new bipyridine-based ligands decorated with phosphine oxide groups. It is expected that the presence of a donor bipyridine moiety and an acceptor phosphine oxide groups will contribute to the occurrence of intramolecular charge transfer. In the present work, bis-cyclometallated Ir(III) complexes based on these ligands were synthesized (Fig. 1) and their photophysical properties were investigated.

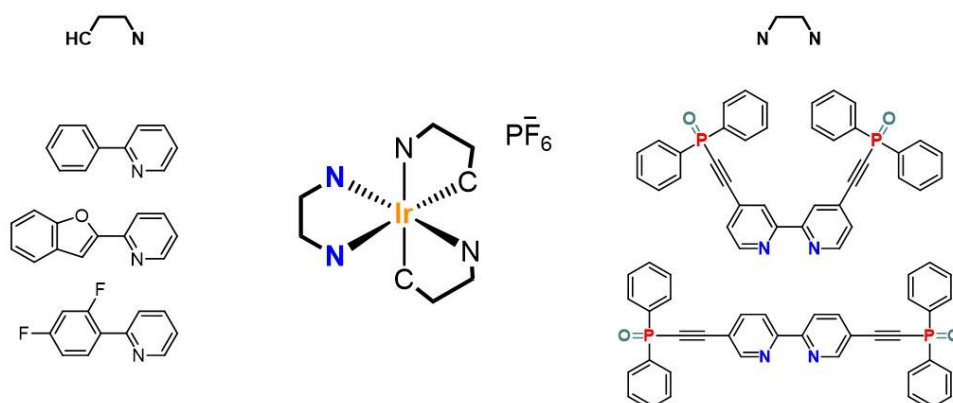

**Figure 1.** Ir(III) complexes synthesized in this work.

The compounds obtained were characterized by  $^1\text{H}$ ,  $^{31}\text{P}$ ,  $^1\text{H}$ - $^1\text{H}$  COSY NMR spectroscopy, ESI<sup>+</sup> mass spectrometry and IR spectroscopy.

## References

- [1] *RSC Adv.* **2014**, *4*, 58826
- [2] *Inorg. Chem.* **2023**, *62*, 5123
- [3] *J. Mater. Chem. C*, **2017**, *5*, 3519

## Acknowledgements

The work was carried out using equipment of Centres for Magnetic Resonance and for Chemical Analysis and Materials Research (Research Park of St. Petersburg State University).

SPECIFICITY OF COMPLEXATION AND PHOTOINDUCED RECOORDINATION OF BIS-AZA-18-CROWN-6-CONTAINING DIBENZYLIDENECYCLOPENTANONE WITH ALKALI AND ALKALINE-EARTH METAL

*Alatorsev O.A.*<sup>1</sup>, *Volchkov V.V.*<sup>2</sup>, *Khimich M.N.*<sup>2</sup>, *Melnikov M.Ya.*<sup>2</sup>, *Fomina M.V.*<sup>3</sup>, *Gromov S.P.*<sup>2,3</sup>

<sup>1</sup> Moscow Institute of Physics and Technology (MIPT), Dolgoprudny, Russia

<sup>2</sup> Moscow State University, Department of Chemistry, Moscow, Russia

<sup>3</sup> Photochemistry Center, KC "Crystallography and Photonics", Moscow, Russia

Student

[alatorcevoleg3@gmail.com](mailto:alatorcevoleg3@gmail.com)

Various derivatives of mono-aza-crown ethers are considered as prototypes of smart photoactive molecular devices, sensors for optical and electrochemical detection of metal cations [1].

In this work, the features of the complexation process and the specifics of the photoinduced recoordination in complexes of ditopic bis-aza-18-crown-6-containing dibenzylidenecyclopentanone (**1**) with alkali and alkaline earth metal cations of various stoichiometry  $1^*(M^{n+})$ ,  $1^*(M^{n+})_2$ ,  $(M^{n+})^* 1^*(M^{n+})_2$  were thoroughly studied. Spectral-kinetic features of investigated complexes (**1**) with metal cations were obtained in MeCN (Table 1).

**Table 1.** Spectral-kinetic features of investigated complexes (**1**) with alkali and alkali-earth cations

Cation	Log[Ks(dm <sup>3</sup> *mol <sup>-1</sup> )]			$\epsilon_a^{\max}/\text{dm}^3\cdot\text{mol}^{-1}\cdot\text{cm}^{-1}$			$\lambda_a^{\max}/\text{nm}$			Cation radius/Å
	(1:1)	(1:2)	(1:3)	(1:1)	(1:2)	(1:3)	(1:1)	(1:2)	(1:3)	
H <sup>+</sup>	3.65	3.60	–	36400	45500	–	448	341	–	–
Li <sup>+</sup>	2.10	–	1.30	63400	–	62600	463	–	500	0.68
Na <sup>+</sup>	3.00	–	–0.30	59800	–	73900	459	–	489	0.97
K <sup>+</sup>	3.08	2.70	–	55300	44800	–	459	452	–	1.33
Mg <sup>2+</sup>	3.03	–	1.90	49700	–	54800	456	–	525	0.66
Ca <sup>2+</sup>	3.90	3.05	–	49600	40400	–	453	422	–	0.99
Ba <sup>2+</sup>	4.40	4.10	–	49600	39100	–	447	371	–	1.34

In the process of investigation we found that the first stage of photoinduced recoordination takes place in complexes of (**1**) with Ba<sup>2+</sup>, Ca<sup>2+</sup>, K<sup>+</sup>. It was proved that the process of photoinduced recoordination could be effectively blocked in the PrCN cold matrix (at 77K condition). It was found that photoinduced recoordination occurs in range of no more than 100fs. Quantum-chemically calculated conformation curves that describe the process of recoordination in ground and excited state signifies that the process of photoinduced recoordination has potential barrier in both states. Moreover, it was established that the process of photoinduced recoordination is conjugated with the process of changing the solvate shell of metal cation that coordinated by aza-crown cavity (**1**) (Scheme 1).

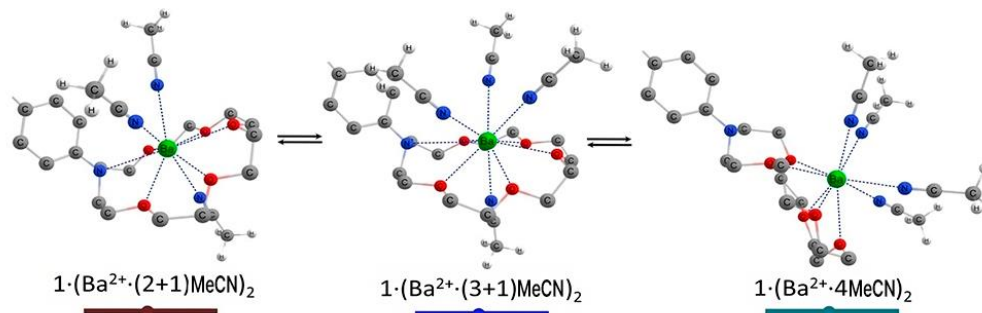

**Scheme 1.** The process of photoinduced recoordination that takes place in complex (**1**) with Ba<sup>2+</sup>. Axial conformation of complex (left) proceeds to equatorial (right) – the result of the process of photoinduced recoordination

## References

[1] *Dalton Trans.* **2012**, 41, 8767

## Acknowledgements

This work was supported by the Russian Science Foundation (Project Number 22-13-00064).

# STUDY OF THE KINETICS OF EXTRACTION OF EUROPIUM AND YTTRIUM IN CARBONATE AND NITRATE MEDIA BY THE IR ATR METHOD

*Aleksandrov T.S.<sup>1</sup>, Smirnov I.V.<sup>1</sup>, Brechalov A.A.<sup>1</sup>, Babitova E.S.<sup>1</sup>, Gorbunov P.E.<sup>1</sup>,*

<sup>1</sup> St. Petersburg State University, St. Petersburg, Russia

Student

[St077084@student.spbu.ru](mailto:St077084@student.spbu.ru)

The use of extraction methods for the separation and concentration of rare-earth elements and radionuclides is currently in high demand. Thus, europium is actively used in microelectronics and nuclear power as a neutron absorber, and knowledge about the extraction of yttrium and its separation from strontium is necessary for the development of a <sup>90</sup>Y isotope generator for use as a radiopharmaceutical.

The purpose of this work is to study the kinetics of extraction of europium nitrate and yttrium carbonate by various organic extractants (triethylphosphine oxide (TAPO), carbomoyl phosphine oxide (CMPO), 2,3-dihydroxynaphthalene and 8-hydroxyquinoline) [1,2] by infrared spectroscopy with attenuated total reflectance (IR ATR). It is shown that the IR ATR method makes it possible to study the kinetics of the extraction process using small volumes of the studied solutions and gives good convergence of the extraction rate constant with the diffusion cell method (for the Eu<sup>3+</sup> - TAPO system  $7.5 \cdot 10^{-4} \text{ cm}^{-1} \text{ s}^{-1}$  by the IR ATR method and  $4.3 \cdot 10^{-4} \text{ cm}^{-1} \text{ s}^{-1}$  by the Lewis cell method). It is also shown that in systems using chelating extractants, the presence of two jumps is observed on kinetic curves, which can be explained by the sequential addition of metal ions to the binding functional groups of extractants (Fig.1).

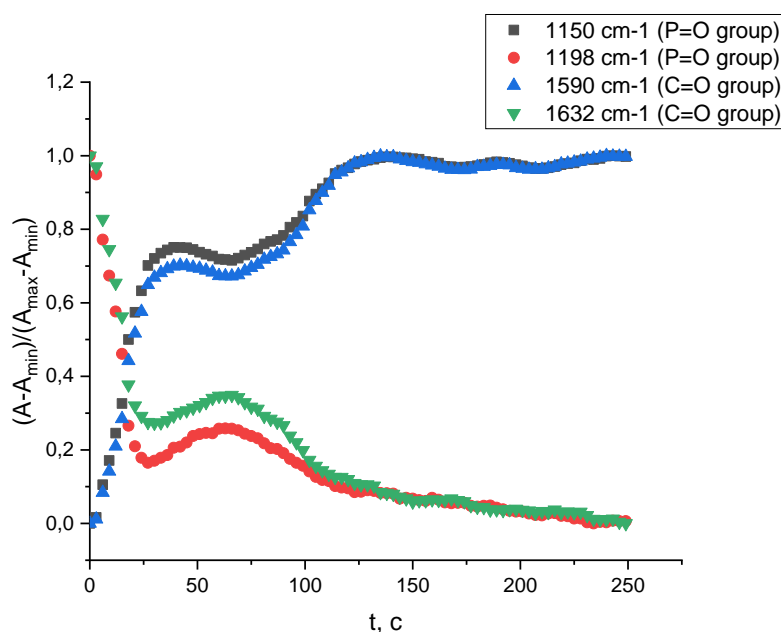

**Figure 1.** Kinetic curves constructed for a series of IR spectra during extraction of Eu<sup>3+</sup> with CMPO solution in 1,2-Dichloroethane

## References

- [1] Zhu Y. and Jiao R., Chinese Experience in the Removal of Actinides from Highly Active Waste by Trialkylphosphine-Oxide Extraction // Nucl. Technol, 1994, Vol. 108, N 3, P. 361– 369.
- [2] Tian M. et al. Applications of the binary mixture of sec-octylphenoxyacetic acid and 8-hydroxyquinoline to the extraction of rare earth elements // Hydrometallurgy. 2012. Vol. 111–112. P. 109–113.

## Acknowledgements

Scientific research were performed at the Research park of St.Petersburg State University «Center for Chemical Analysis and Materials Research».

This work was supported by the Russian Science Foundation (project № 24-63-00006), <https://rscf.ru/project/24-63-00006/>.

# PHOSPHINE OXIDES AS PROBES FOR STUDYING HYDROGEN BONDING

*Omar Alkhuder<sup>1</sup>, Mikhail A. Kostin<sup>1</sup>, Peter M. Tolstoy<sup>1</sup>*

<sup>1</sup> Institute of Chemistry, St. Petersburg State University, St. Petersburg, Russia  
Student PhD

[omar.alkhuder2016@gmail.com](mailto:omar.alkhuder2016@gmail.com)

The spectroscopic properties of the P=O acceptor group of phosphine oxides can be used to characterize intermolecular complexes with their participation. Phosphine oxides are used in <sup>31</sup>P NMR spectroscopy as probes to characterize the electron withdrawing properties of solvents and other compounds with Lewis acidity (so-called Gutmann-Beckett acceptor number scale) [1] and proton donating ability of compounds with Brønsted acidity [2]. Previously, calculated <sup>31</sup>P NMR chemical shifts of phosphine oxides were used to theoretically estimate the strength of non-covalent interactions, halogen bonds and hydrogen bonds [3, 4, 5].

In this work, hydrogen bonds between triphenylphosphine oxide and 24 substituted phenols were studied using liquid-state NMR spectroscopy in a polar aprotic solvent (liquefied freonic mixture CDF<sub>3</sub>/CDF<sub>2</sub>Cl) and in the crystalline solid state.

Two kinds of complexes were identified in low-temperature (100 K) <sup>1</sup>H and <sup>31</sup>P NMR spectra: 1:1 complexes, and 1:2 complexes. For example, **Scheme 1a** shows the corresponding signals of 1:1 and 1:2 complexes of triphenylphosphine oxide and 4-chlorophenol.

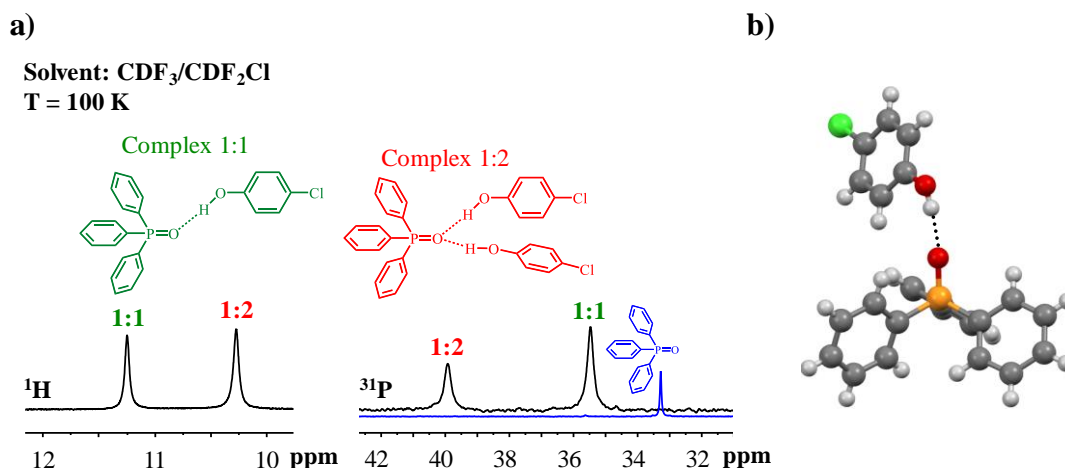

**Scheme 1.** <sup>1</sup>H and <sup>31</sup>P NMR spectra of Ph<sub>3</sub>P=O complexes with 4-chlorophenol in solution in CDF<sub>3</sub>/CDF<sub>2</sub>Cl at 100 K.

Using previously established correlation linking the <sup>1</sup>H NMR chemical shift changes upon complexation,  $\Delta\delta_H$ , with the enthalpy of complexation,  $\Delta H$ , we were able to estimate the enthalpy of complexation and thus to establish an empirical power relationship between the enthalpy of complexation with the change in the chemical shift of phosphorus  $\Delta\delta_P$ :

$$\Delta H(\text{in kJ/mol}) \approx 17 \cdot \Delta\delta_P(\text{in ppm})^{0.5}$$

Using X-ray diffraction analysis, we were able to study the complexes formed in the solid state (see example in **Scheme 1b**) and build experimental correlations between the hydrogen bond length and the change in the chemical shift of phosphorus  $\Delta\delta_P$  upon complexation in the solid state.

## References

- [1] J. A. McCune et al., *Phys. Chem. Chem. Phys.*, **2014**, *16*, 23233–23243.
- [2] E. Pires and et al., *Phys. Chem. Chem. Phys.*, **2020**, *22*, 24351–24358.
- [3] A.S. Ostras' et al., *Molecules.*, **2020**, *25*, 1406.
- [4] E.R. Chakalov et al., *Molecules.*, **2022**, *27*, 4848.
- [5] M.A. Kostin et al., *Phys. Chem. Chem. Phys.*, **2022**, *24*, 7121.

## Acknowledgements

This work is supported by the RSF grant 23-13-00095. The NMR spectra were recorded at the Center for Magnetic Resonance of SPbU Research Park.

# SOLID STATE CONTROL OF THE PHOSPHORESCENCE OF PLATINUM(II) COMPLEXES BY INTERMOLECULAR INTERACTIONS

*Antonova E.V.<sup>1</sup>, Kinzhalov M.A.<sup>1</sup>*

<sup>1</sup>St. Petersburg State University, St. Petersburg, Russia

Student

st055686@student.spbu.ru

The optical properties of C<sup>N</sup>-cyclometallated platinum(II) complexes [Pt(C<sup>N</sup>)(L,L')]<sup>2</sup> depend on the molecular structure of the compounds and supramolecular aggregation, causing polymorphs of the same compound to have different photophysical properties. It is a challenging goal to control the formation of polymorphic forms of platinum(II) complexes due to the multiple complex-complex and complex-solvent interactions during crystallization.

A series of previously uncharacterized cyclometallated platinum(II) complexes with isocyanide ligands [(ppy)PtCl(CNR)] (R = C<sub>6</sub>H<sub>4</sub>-2-I **1**, C<sub>6</sub>H<sub>4</sub>-4-I **2**, C<sub>6</sub>H<sub>3</sub>-2-F-4-I **3**, C<sub>6</sub>H<sub>3</sub>-2,4-I<sub>2</sub> **4**, C<sub>6</sub>H<sub>4</sub>-C≡C-Ph **5**) were studied [1, 2]. Crystallization of **1-4** under different conditions resulted in a number of polymorphic crystals and solvates (**1**<sup>1</sup>/**1**<sup>II</sup>, **2**<sup>1</sup>/**2**<sup>II</sup>, **3**<sup>1</sup>/**3**<sup>II</sup> и **4**/**4**·CHCl<sub>3</sub>), with different photophysical characteristics. Crystallization of the **2** from the solution of CH<sub>2</sub>Cl<sub>2</sub> leads to the formation of yellow needle crystals **2**<sup>1</sup>, which are luminescent in the green region of the visible light. At the same time, crystallization of the **2** from the hot EtCN solution leads to the formation of orange prisms **2**<sup>II</sup>, which exhibit a shift of the luminescence maximum to the red region. While **2**<sup>1</sup> is a weak emitter (0.5%), the **2**<sup>II</sup> polymorph has a 24-fold higher luminescence quantum yield (12%). The adduct **5**·½(1,4-DITFB) was obtained by crystallization of **5** with 1,4-diodotetrafluorobenzene (1,4-DITFB) and exhibits higher luminescence quantum yield compared to the complex **5** without changing the spectral parameters. The difference in the luminescence efficiency can be associated with the absence or presence of intermolecular interactions: Pt···Pt and C-I···Cl-Pt interactions (**2**<sup>II</sup> crystals) and π-hole(isocyano group)···d<sub>z<sup>2</sup></sub>[Pt<sup>II</sup>] interaction (the adduct **5**·½(1,4-DITFB)) increase structure rigidity, decrease vibrational relaxation, and, consequently, increase photoluminescence quantum yield. The remaining crystals **1**<sup>1</sup>/**1**<sup>II</sup>, **3**<sup>1</sup>/**3**<sup>II</sup> and **4**/**4**·CHCl<sub>3</sub>, as well as samples **2**<sup>1</sup> and the adduct **5**·½(1,4-DITFB), are luminescent in the green region.

The report will summarize the results of the research on the impact of noncovalent interactions upon the luminescence efficiency of cyclometallated platinum(II) complexes with isocyanide ligands.

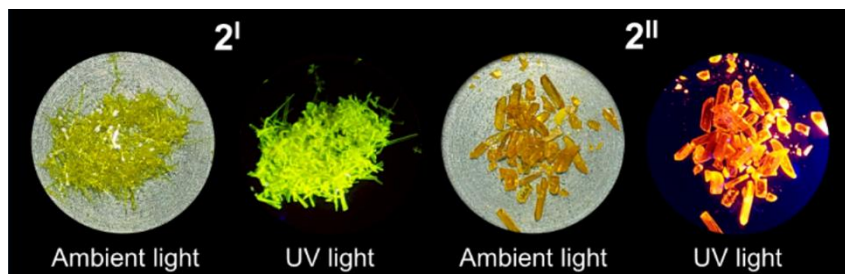

**Figure 1.** Images of crystals of **2**<sup>I</sup> and **2**<sup>II</sup> in visible light and under UV radiation.

## References

- [1] *ACS Omega* **2022**, 7, 38, 34454-34462
- [2] *Inorganics* **2023**, 11, 10, 403

## Acknowledgements

This work was supported by a grant from the Ministry of Science and Higher Education of the Russian Federation for large-scale research projects in high priority areas of scientific and technological development (grant number 075-15-2024-553). Measurements were performed in the Research Park at St. Petersburg University (the resource centres CMR, CXDS, CCAMR, CLMR, DCE and CC).

## NEW SYNTHESIS METHODS OF DEACARBONYL DITECHNETIUM-99

*Babitova E.S.<sup>1</sup>, Sakhonenkova A.P.<sup>1</sup>, Miroslavov A. Ye.<sup>1</sup>, Brechalov A.A.<sup>1</sup>*

<sup>1</sup> St. Petersburg State University, St. Petersburg, Russia

1<sup>st</sup> year master student

[st064214@student.spbu.ru](mailto:st064214@student.spbu.ru)

Also  $M_2(CO)_{10}$  ( $M = Re, Mn$ ) are precursors in many reactions, including the synthesis of metal cluster compounds, their analog,  $^{99}Tc_2(CO)_{10}$ , remains poorly studied. This is probably due to the complexity of its preparation: the synthesis of  $^{99}Tc_2(CO)_{10}$  requires so far high pressure of a carbon monoxide (up to 350 atm) and a temperature of 220°C [1]. It is known that, salts of technetium acid - pertechnetates, as well as technetium dioxide are used as starting compounds for preparing  $^{99}Tc_2(CO)_{10}$ . However, the yield of  $^{99}Tc_2(CO)_{10}$  prepared from these precursors is not high probably due to their low solubility in organic solvents.

In this work, we prepared ditechnetium decacarbonyl from a solution of  $HTcO_4$ , in 1,4-dioxane, 1,2-dimethoxyethane and tetrahydrofuran. The synthesis parameters (temperature, time) were optimized. The highest yield (70%) of  $^{99}Tc_2(CO)_{10}$  was obtained with 1,2-dimethoxyethane. The product was characterized by IR spectroscopy.

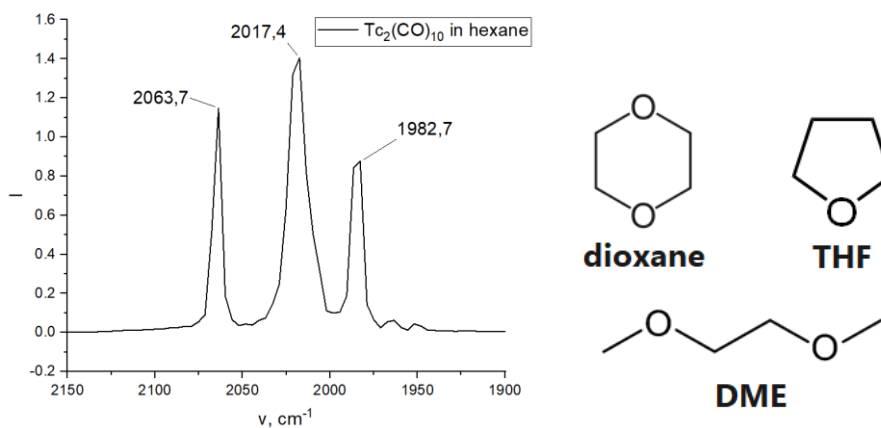

**Figure 1.** The IR spectrum of decacarbonyl ditechnetium in hexane and solvents used.

### References

[1] *J. Am. Chem. Soc.* **1961**, 83, 2953

## SYNTHESIS OF NANOCRYSTALLINE $\text{Bi}_2\text{Cr}_{0.5}\text{Co}_{0.5}\text{Nb}_2\text{O}_{9+\Delta}$ CERAMICS

*Badanina K.A.<sup>1</sup>, Korolev R.I.<sup>1</sup>, Makeev B.A.<sup>2</sup>, Zhuk N.A.<sup>1</sup>*

<sup>1</sup> Syktyvkar State University, Syktyvkar, Russia

<sup>2</sup> Institute of Geology of the Komi Science Center UB RAS, Syktyvkar, Russia  
Student

[Badanina-Ksenia@mail.ru](mailto:Badanina-Ksenia@mail.ru)

Bismuth-containing pyrochlores are characterized by a significant set of practically useful properties in demand, among which dielectric and photocatalytic properties are especially distinguished. Oxide bismuth-containing pyrochlores, having low dielectric loss tangent values and high dielectric constant, are promising as tunable microwave dielectric components and dielectric layer in multilayer ceramic capacitors.

It has been shown that the modified sol-gel method (Pechini method) successfully synthesizes multielement oxides based on bismuth niobate, crystallizing in the pyrochlore structure type (space group  $Fd\bar{3}m$ ). It has been established that for the synthesis of niobium-containing complex oxides by the Pechini method, the corresponding metal oxides can be used as precursors by wisely selecting an acid solvent for them. The synthesis temperature of a single-phase sample is 950 °C, which is one hundred degrees lower than the calcination temperature in the traditional ceramic synthesis method. The average crystallite size, determined by X-ray diffraction, varies from 39 (850 °C) to 48 nm (1050 °C) depending on the sintering temperature. According to X-ray phase analysis, the unit cell parameter is 10.4872(6) Å. The results of elemental mapping indicate a uniform distribution of metal atoms on the surface of the sample, and X-ray energy dispersive analysis showed that the chemical composition of the synthesized sample corresponded to the specified theoretical composition.

# FeLn<sub>2</sub>(SeO<sub>3</sub>)<sub>4</sub>X (Ln=La, Ce, Pr, Nd; X=Cl, Br) PHASES: SYNTHESIS, CRYSTAL STRUCTURE, MAGNETIC PROPERTIES

*Belareva M.A.*<sup>1</sup>, *Murtazoev A.F.*<sup>1,2</sup>, *Moskin A.V.*<sup>2</sup>, *Berdonosov P.S.*<sup>1</sup>, *Vasiliev A.N.*<sup>1,2</sup>

<sup>1</sup> Moscow State University, Moscow, Russia

<sup>2</sup> NUST MISIS, Moscow, Russia

Student

[miriam.belareva@chemistry.msu.ru](mailto:miriam.belareva@chemistry.msu.ru)

Nowadays compounds with low-dimensional magnetic properties are of increasing interest. These compounds exhibit magnetic properties due to the interactions between individual ions or clusters of ions. Heterometallic compounds containing magnetic 3d-cations and 4f-cations attract particular attention. Recently, new compound FeNd<sub>2</sub>(SeO<sub>3</sub>)<sub>4</sub>Cl was reported. In this compound Nd<sup>3+</sup> cations form a distorted Shastry-Sutherland lattice and Fe<sup>3+</sup> cations form a triangular lattice [1]. The temperature dependence of magnetic susceptibility indicates that there is no magnetic order down to 2K. However, a sharp peak at ~6.7 K on the temperature dependence of heat capacity was observed. Therefore, compound was supposed by authors to exhibit «hidden antiferromagnetic ordering».

The purpose of this work is to search chloride and bromide analogs of FeNd<sub>2</sub>(SeO<sub>3</sub>)<sub>4</sub>Cl phase with other rare-earth elements and to study magnetic and thermodynamic properties of these phases.

The samples were synthesized through hydrothermal and solid state methods. PXRD of samples showed that FeLn<sub>2</sub>(SeO<sub>3</sub>)<sub>4</sub>Cl phase was formed for Ln=La, Ce, Pr, Nd. FeLn<sub>2</sub>(SeO<sub>3</sub>)<sub>4</sub>Br phase was formed only for Ln=La.

The single crystals of FeLa<sub>2</sub>(SeO<sub>3</sub>)<sub>4</sub>Cl, FeLa<sub>2</sub>(SeO<sub>3</sub>)<sub>4</sub>Br, FeCe<sub>2</sub>(SeO<sub>3</sub>)<sub>4</sub>Cl, FePr<sub>2</sub>(SeO<sub>3</sub>)<sub>4</sub>Cl were investigated via single-crystal X-ray diffraction. The experiments show that these compounds are isostructural and crystallize in a monoclinic space group C2/c. The [LnO<sub>10</sub>]<sup>17-</sup> polyhedra are connected via selenite groups to form layers. The layers of iron polyhedra are formed by chains in which [FeO<sub>4</sub>Cl]<sup>6-</sup> tetragonal pyramids are connected via selenite groups.

The PXRD patterns of FeLn<sub>2</sub>(SeO<sub>3</sub>)<sub>4</sub>Cl (Ln = La, Ce, Pr, Nd) were indexed. In the La — Nd row the unit cell volume decreases in accordance with the lanthanide contraction. For this reason, bromide phase is formed only in the case of La<sup>3+</sup>, because this cation has the largest ionic radius.

The temperature dependence of magnetic susceptibility was measured for the compounds FeLn<sub>2</sub>(SeO<sub>3</sub>)<sub>4</sub>Cl, Ln=La, Ce, Pr. The temperature dependence of heat capacity was measured for FeLa<sub>2</sub>(SeO<sub>3</sub>)<sub>4</sub>Cl. These dependences show that lanthanum compound behaves differently than cerium and praseodymium compounds. Its properties may be described by the Heisenberg spin chain. This compound exhibits the magnetic order at 6.5 K.

## References

[1] *J Solid State Chem.* **2020**, 286, 121315

## Acknowledgements

This work was supported by the Russian Science Foundation (project No 23-23-00205).



## DIRECTED DESIGN OF BRIGHTLY LUMINESCENT MIXED-CARBOXYLATE BENZOATE-PENTAFLUOROBENZOATE LANTHANIDE COMPLEXES

*Bolotko A.E.*<sup>1,2</sup>, *Shmelev M.A.*<sup>2</sup>, *Chistyakov A.S.*<sup>2</sup>, *Taydakov I.V.*<sup>3</sup>, *Varaksina E.A.*<sup>2,3</sup>, *Sidorov A.A.*<sup>2</sup>, *Eremenko I.L.*<sup>2</sup>

<sup>1</sup>Faculty of Chemistry of Higher School of Economics, Moscow, Russia

<sup>2</sup>N.S. Kurnakov Institute of General and Inorganic Chemistry of the Russian Academy of Sciences, Moscow, Russia

<sup>3</sup>P.N. Lebedev Physical Institute of the Russian Academy of Sciences, Moscow, Russia  
Student

[al.bolotko@gmail.com](mailto:al.bolotko@gmail.com)

The increase of the photoluminescence efficiency of lanthanide coordination compounds is one of the urgent tasks today. Coordination compounds of lanthanides attract much attention with a variety of their potential applications. They may be applied as sensors, diodes and lasers or in catalysis and biomedical imaging. The introduction of the d-block which consists of d10-metal ions and aromatic organic ligands may affect the photoluminescent properties of lanthanide complexes positively due to the antenna effect [1]. Using two types of anions of aromatic acids of different nature leads, on the one hand, to the stabilization of the crystal structure due to the occurrence of strong non-covalent interactions [2] and, on the other hand, to an improvement in their photoluminescent characteristics [3]. For instance, simultaneous coordination of benzoic and pentafluorobenzoic acid anions to a REE metal ion leads to the formation of supramolecular chains stabilized by  $\pi\cdots\pi$ , C-H...F, C-F... $\pi$  and other non-covalent interactions, which can have a significant effect on photoluminescent properties.

In this work mixed-carboxylate  $\{Zn_2Ln_2\}$  complexes  $[Zn_2Ln_2(bz)_x(pfb)_{10-x}(phen)_2]$  ( $Ln = Eu$ (**1Eu**),  $Tb$ (**1Tb**),  $Gd$ (**1Gd**);  $bz$  – benzoate anion;  $pfb$  – pentafluorobenzoate anion;  $phen$  – 1,10-phenanthroline;  $x=5,4; 1,2$ ) and their benzoate and pentafluorobenzoate analogues  $[Zn_2Ln_2(bz)_{10}(phen)_2]$  ( $Ln = Eu$ (**2Eu**),  $Tb$ (**2Tb**)) and  $[Zn_2Ln_2(pfb)_{10}(phen)_2]$  ( $Ln = Eu$ (**3Eu**),  $Tb$ (**3Tb**)) were obtained. The obtained compounds were characterized by XRD, CHN analysis and IR spectroscopy. In the structure of compounds **1** the occupancy of four anions is non-integer and  $bz$ - and  $pfb$ -anions occupy the same position. The occupancy of hydrogen and fluorine atoms may change with varying synthesis conditions. It has been shown that simultaneous coordination of  $bz$ - и  $pfb$ -anions to the REE ion ( $Eu$ ,  $Tb$ ,  $Gd$ ) with 1,10-phenanthroline leads to the emergence of non-covalent interactions which stabilize the crystal packaging of the complexes. In the case of compounds **1**, an increase in luminescence efficiency is observed to 50% and 54% for **1Eu** and **1Tb**, respectively, which is about 1,3 times more than for their benzoate and pentafluorobenzoate analogues **2** and **3**.

### References

- [1] *Russian Journal of Coordination Chemistry* **2016**, 42, 640
- [2] *Cryst. Eng. Comm.* **2018**, 20, 6677
- [3] *Inorganic Chemistry* **2016**, 58(5), 3265

### Acknowledgements

This work was supported by the Russian Science Foundation (project No 22-73-10192).

# RARE EARTH FLUOROTRIFLUOROACETATES: SYNTHESIS, STRUCTURE AND LUMINESCENCE PROPERTIES

*Boltkov E.D.*<sup>1</sup>, *Belousov Yu.A.*<sup>1</sup>, *Lermontova E.Kh.*<sup>2</sup>, *Goncharenko V.E.*<sup>3</sup>, *Glazunova T.Yu.*<sup>1</sup>

<sup>1</sup> Lomonosov Moscow State University, Moscow, Russia

<sup>2</sup> Kurnakov Institute of General and Inorganic Chemistry of the Russian Academy of Sciences (IGIC RAS), Moscow, Russia

<sup>3</sup> HSE University

Graduate student

[mr.boltkov@icloud.com](mailto:mr.boltkov@icloud.com)

Several series of REE fluorotrifluoroacetates have been synthesized and characterized. The crystal structure of each compound is based on a structural fragment studied in our laboratory, the rhombododecahedron  $\{Ln_6F_8\}$  [1]. Compounds containing this fragment are poorly illuminated in papers and are often synthesized by accident [2,3]. The metal ions in the rhombic dodecahedron are connected in pairs by twelve bidentate trifluoroacetate anions. These compounds are, firstly, of fundamental interest for crystal chemistry, and secondly, of practical interest - obtaining luminescent materials that are stable over a wide temperature range (up to 250–300°C) with outstanding characteristics (due to the rigidity of the structure and the absence of quenching bonds).

This work demonstrates the potential existence of the  $\{Ln_6F_8\}$  fragment for a wide range of lanthanides (Pr – Yb). The use of cations of various alkali metals makes it possible to control the dimensions of the resulting compounds (1D, 2D and 3D). It has been shown that the use of pyridinium cation leads to the formation of 0D crystal structures. The possibility of replacing axial molecules of trifluoroacetic acid and water with molecules of pyridine and dioxane has been demonstrated.

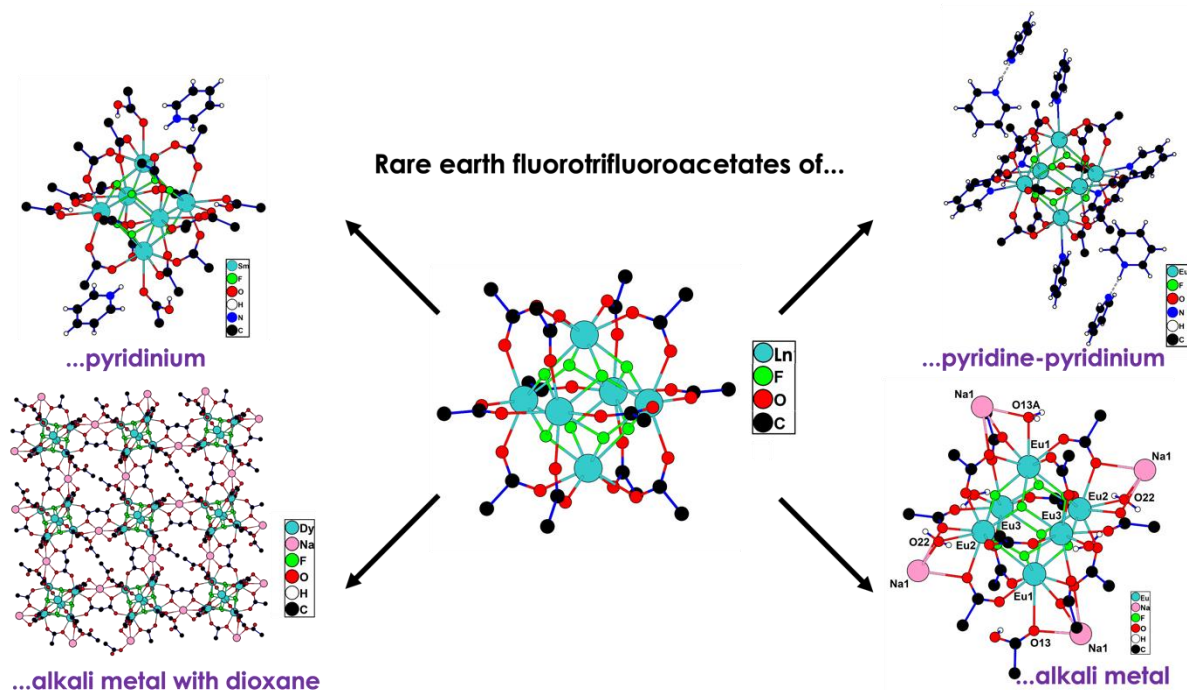

**Figure 1.** Connection between REE fluorotrifluoroacetates.

## References

- [1] *Collect. of abst. of the conf. "Crystallochem. aspects of the creation of new materials: theory and practice"* **2021**, 8, 36
- [2] *Chem. Comm.* **2020**, 56, 9130
- [3] *Dalt. Trans.* **2022**, 51, 4814

## Acknowledgements

This work was supported by the Russian Science Foundation (project No 22-72-10034).

## EXTRACTION SEPARATION OF YTTRIUM FROM STRONTIUM IN CARBONATE MEDIA

*Brechalov A.A.<sup>1</sup>, Babitova E.S.<sup>1</sup>, Aleksandrof T.S.<sup>1</sup>, Smirnov I.V.<sup>1</sup>*

<sup>1</sup> St. Petersburg State University, St. Petersburg, Russia  
Student

[st052691@student.spbu.ru](mailto:st052691@student.spbu.ru)

Yttrium, being a dispersed element, plays a significant role in industry, including nuclear medicine. To date, numerous methods have been developed for extracting yttrium from complex matrices, such as ion-exchange chromatography and liquid-liquid extraction. One of the most promising methods is membrane separation using a liquid membrane, which allows for the simultaneous extraction and stripping operations, effectively utilizing organic extractants. Such systems have also been proposed for use in yttrium-strontium generators [1].

Previous studies have shown that for the selective separation of trace amounts of yttrium from strontium in carbonate media, synergistic mixtures of methyltrioctylammonium carbonate (MTOAC) with aromatic alcohols such as 2,3-dihydroxynaphthalene (2,3-DHN) and 8-hydroxyquinoline (8-HQ) can be used as extractants [2].

In this study, liquid and membrane extraction of yttrium and strontium from carbonate media were investigated using solutions of synergistic mixtures of phenols with quaternary ammonium bases as the organic phase. It was shown that at a concentration of 0.005 M, both 8-HQ and 2,3-DHN exhibit distribution coefficients sufficient for membrane separation, as presented in Table 1.

**Table 1.** Extraction characteristics of the studied systems.

Extractants	Solvent	$D_Y$	Stripping degree in 0,05 M $HNO_3$
2,3-DHN	dibutyl phthalate	0,2	0,4
8-HQ	dibutyl phthalate	0,07	0,6
2,3-DHN	dibutyl phthalate with dichloroethane, 1:1	0,2	1
8-HQ	dibutyl phthalate with dichloroethane, 1:1	0,2	0,4

Furthermore, the selectivity coefficients of these extractants for the Y/Sr pair exceed  $10^4$ , making the studied systems applicable in Y/Sr generators.

### References

- [1] *Chem. Pap.* **2018**, 72, 1487  
[2] *Radiochemistry* **2023**, 65, 219

### Acknowledgements

This work was supported by the Russian Science Foundation (project No 24-63-00006), <https://rscf.ru/project/24-63-00006/>

Scientific research were performed at the Research park of St.Petersburg State University «Center for Chemical Analysis and Materials Research».

# SYNTHESIS AND STUDY OF POLYNUCLEAR REE HYDROXOTRIFLUOROACETATES

*Burlakova M.A.<sup>1</sup>, Tsymbarenko D.M.<sup>1</sup>, Grebenyuk D.I.<sup>2,3</sup>*

<sup>1</sup> Department of Chemistry, Lomonosov Moscow State University, Moscow, Russia

<sup>2</sup> Faculty of Materials Science, Lomonosov Moscow State University, Moscow, Russia.

<sup>3</sup> Faculty of Materials Science, MSU-BIT University, Shenzhen, China.

Postgraduate

[mariia.burlakova@chemistry.msu.ru](mailto:mariia.burlakova@chemistry.msu.ru)

Nowadays the lanthanide complexes possess structural flexibility and can be affected by structural or chemical transformations (e.g. hydrolysis) [1]. It is the fact that makes it difficult to stabilize the core of a certain shape, and it is the technique of self-controlled hydrolysis that provides the growth and stabilization of required core [2]. The chemical transformations of lanthanide carboxylates, including trifluoroacetates, in a presence of amines are being actively studied. Mono- and binuclear mixed-ligand complexes, polynuclear hydroxocomplexes and hydroxogels are known as products of these transformations reflecting the competition between complexation and hydrolysis processes. Other way to control the nuclearity of complexes is using polydentate organic ligands, such as polyatomic amines.

In the present work the effect of diethylenetriamine (deta) on crystallization of lanthanide trifluoroacetates was studied. The crystalline lanthanide *tetrakis*-trifluoroacetates  $[(\text{detaH}_2)[\text{Ln}_2(\text{tfa})_8](\text{Solv})_x]$  for Ln = La–Eu, polymeric complexes with cubane core  $[\text{Ln}_4(\text{OH})_4(\text{tfa})_8(\text{H}_2\text{O})_4]_n \cdot x \text{H}_2\text{O}$  for Ln = Pr–Lu, Y, tetranuclear and nonanuclear complexes with cubane core  $[\text{Ln}_4(\text{OH})_4(\text{tfa})_3(\text{deta})_4(\text{detadCH})_2](\text{tfa})_3 \cdot x \text{Solv}$ ,  $[\text{Ln}_4(\text{OH})_4(\text{tfa})_2(\text{deta})_4(\text{detadCH})_2](\text{tfa})_4 \cdot x \text{Solv}$ ,  $[\text{Ln}_9(\text{OH})_{12}(\text{tfa})_{11}(\text{deta})_6(\text{detadCH})_2](\text{tfa})_2 \cdot x \text{Solv}$  for Ln = La–Dy were isolated from gel-matrix in the deficiency of deta, while the excess of deta leads to viscous homogeneous gel-like solutions stable to spontaneous crystallization and suitable for preparation of inorganic materials. To study the processes occurring in solution during the formation of polynuclear rare earth clusters, the method of total X-ray scattering with analysis of the pair distribution function (PDF) was used.

The structure of metal-oxo cores for all types of complexes are presented in Figure 1.

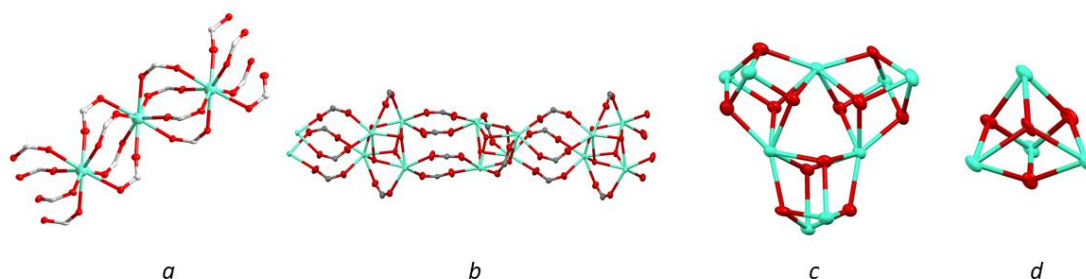

**Figure 1.** The structure of polynuclear core: *a* – anionic chain, *b* – polymer with cubane core, *c* – nonanuclear cluster with three cubane core, *d* – isolated cubane core.

## References

[1] *Nat. Chem.* **2014**, 6, 673.

[2] *Eur. J. Inorg. Chem.* **2019**, 26, 3103.

## Acknowledgements

This work was supported by the Russian Science Foundation (project No 22-73-10089).

# CHALCOGEN BONDING INVOLVING SQUARE PLANAR PLATINUM(II) COMPLEXES BEARING CHELATING LIGANDS

*Busygina A.A.<sup>1</sup>, Eliseeva A.A.<sup>1</sup>, Rozhkov A.V.<sup>1</sup>*

<sup>1</sup> St. Petersburg State University, St. Petersburg, Russia

Student

[st077081@student.spbu.ru](mailto:st077081@student.spbu.ru)

Noncovalent interactions play an important role in many advanced areas of modern science ranging from polymer chemistry to molecular biology. While amount of studies on hydrogen bonding, halogen bonding, and metallophilic interactions involving metal centers is gradually increased, many novel types of noncovalent forces including, e.g., metal-involving chalcogen bonding were recognized only recently thus providing a new tool for crystal engineering [1].

Square-planar transition metal complexes bearing sterically available  $d_z^2$ -orbitals are the most suitable objects for constructing supramolecular systems via noncovalent interactions involving metal centers [2,3]. In this work, two new platinum(II) complexes with chelating ligands, viz. [Pt(PPy)(S<sub>2</sub>CN(CH<sub>2</sub>)<sub>n</sub>)] (PPy – 2-phenylpyridine; n = 4 (1), 6 (2)), were synthesized. The complexes were co-crystallized with chalcogen bond donors, namely bis(perfluoropyridyl) telluride (FPy)<sub>2</sub>Te and bis(perfluorotolyl) telluride (FTol)<sub>2</sub>Te, to give three new cocrystals – 1·(FPy)<sub>2</sub>Te, 2·(FPy)<sub>2</sub>Te, and 2·(FTol)<sub>2</sub>Te, respectively. The structures of the obtained adducts were studied by single-crystal X-ray diffraction (XRD; Fig. 1).

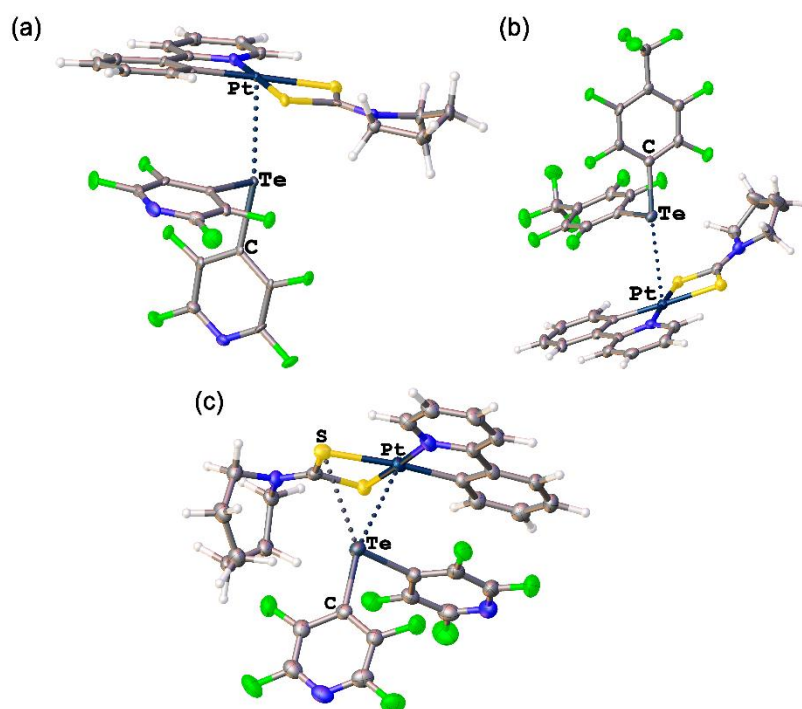

**Figure 1.** Metal-involving chalcogen bonds in cocrystals: (a) 2·(FPy)<sub>2</sub>Te, (b) 2·(FTol)<sub>2</sub>Te, and (c) 1·(FPy)<sub>2</sub>Te.

Upon analysis of noncovalent interactions in the XRD structures of the cocrystals, we identified various types of intermolecular contacts. In addition to previously known  $\pi$ - $\pi$  stacking, LP(F)··· $\pi$ , and Te···S interactions, we found rare metal-involving Te···Pt<sup>II</sup> chalcogen bonds (Fig. 1a and 1b) and recognized hitherto unknown bifurcated ( $\mu_2$ -Te)···[Pt<sup>II</sup>,S] contacts (Fig. 1c). The noncovalent nature of the revealed interactions was confirmed theoretically by DFT calculations via several computational tools.

## References

- [1] *J. Am. Chem. Soc.* **2021**, 143(38), 15701
- [2] *Inorg. Chem. Front.* **2022**, 9, 2869
- [3] *Inorg. Chem. Front.* **2021**, 8(10), 2505

# NOVEL STABLE YTTERBIUM ACETYLACETONATE–QUINALDINATE COMPLEXES AS SINGLE-MOLECULE MAGNETS AND SURPRISINGLY EFFICIENT LUMINOPHORES

*Buzoverov M.E.<sup>1</sup>, Gavrikov A.V.<sup>1</sup>, Ilyukhin A.B.<sup>1</sup>, Efimov N.N.<sup>1</sup>*

<sup>1</sup>Kurnakov Institute of General and Inorganic Chemistry of the Russian Academy of Sciences,  
Moscow, Russia  
PhD student  
[agentneopentan@gmail.com](mailto:agentneopentan@gmail.com)

This work reports the preparation and study of two ytterbium complexes based on quinaldine-2-carboxylate ions (Q). The first compound has 1D-polynuclear nature and have formula  $[\text{Yb}(\text{acac})_2(\text{Q})]_n$  (**1**,  $\text{acac}^-$  = acetylacetonate anion,  $\text{Q}^-$  = quinaldinate anion). Structure of this compound is formed by  $\{\text{Yb}(\text{acac})_2\}^+$  moieties connected into chains *via* bridging Q-anions (Fig.1a). The addition of 1,10-phenanthroline (Phen) as a bulky chelating ligand leads to the formation of a mononuclear 8-coordinated complex  $[\text{Yb}(\text{acac})_2(\text{Q})(\text{Phen})]$  (**2**, Fig. 1c). The coordination polyhedron of the ytterbium ion in **1** and **2** is, respectively, a capped octahedron and a square antiprism.

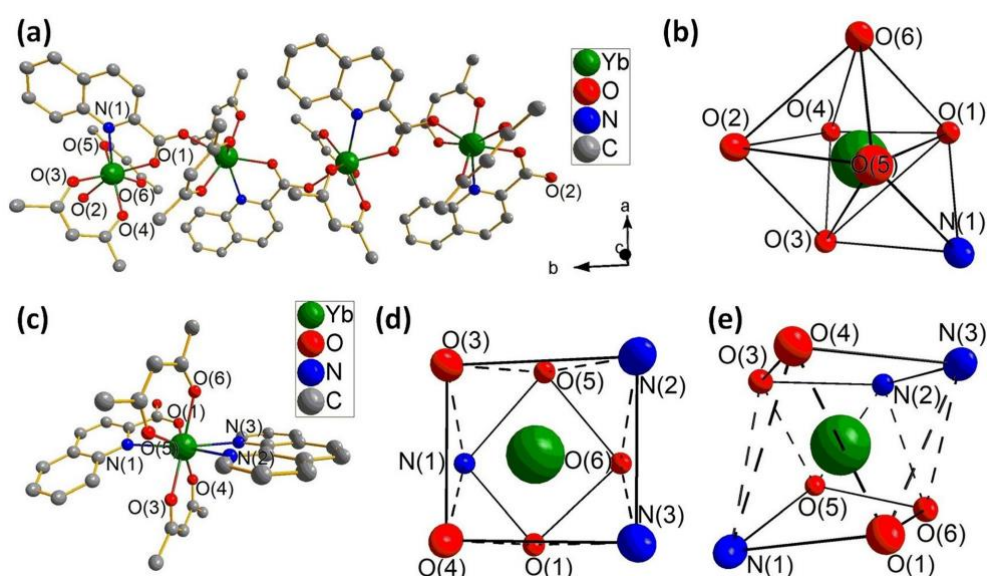

**Picture 1.** Fragment of the molecular structure of compounds **1** (a) and **2** (c). Coordination environment of the Yb<sup>3+</sup> ion in **1** (b) and **2** (d,e). Hydrogen atoms are omitted for clarity.

Investigation of the dynamic magnetic properties of **1** and **2** reveals presence of the single molecule magnets (SMM) properties. The experimental data fitting showed that relaxation proceeds *via* Raman and QT mechanisms. Although Orbach mechanism is typically not the case for complexes based on Yb<sup>3+</sup> ions [1], it was involved in the fitting to compare SMM performance of **1** and **2** with that of reported Yb-based SMMs. The higher demagnetization barrier,  $U_{\text{eff}}$ , for compound **1** is due to the more favorable geometry of the coordination environment, which positively affects the magnetic anisotropy of the Yb<sup>3+</sup> ion.

IR luminescence properties of complexes **1** and **2** also was studied. As a result of studying the kinetics of luminescence decay, the quantum yields were determined to be 2 and 4% for **1** and **2**, respectively. Interestingly, **2** shows one of the highest quantum yields among ytterbium  $\beta$ -diketonate complexes despite on many C-H quenchers. This is probably due to the lower number of C-O-oscillators in the first coordination sphere of Yb<sup>3+</sup> compared to **1** and reported *tris*-diketonates) coordinating Yb<sup>3+</sup> and contributing to nonradiative luminescence quenching. Another advantage of compound **2** over **1** is its mononuclear structure with distant 10.13 Å between Yb<sup>3+</sup> ions. This feature prevents cross-relaxation processes between neighboring Yb<sup>3+</sup> ions.

## References

[1] *Inorg. Chem.* **2015**, *54*, 7600

## Acknowledgements

This work was supported by the Russian Science Foundation (project No 22-73-10189).

# TUNING OF CRYSTAL STRUCTURES OF ORGANIC-INORGANIC METAL HALIDES FOR REDUCING THE BANDGAP FOR LEAD-FREE PEROVSKITE PHOTOVOLTAICS

*Bykov A.V.<sup>1</sup>, Shestimerova T.A.<sup>1</sup>, Gontcharenko V.E.<sup>2,3</sup>, Shevelkov A.V.<sup>1</sup>*

<sup>1</sup> Department of Chemistry, Moscow State University, Moscow, Russia

<sup>2</sup> Faculty of Chemistry, Higher School of Economics, Moscow, Russia

<sup>3</sup> Lebedev Physical Institute, Russian Academy of Sciences, Moscow, Russia

PhD Student

[bykov.andrey.sw@gmail.com](mailto:bykov.andrey.sw@gmail.com)

In recent decades, the efficiency of solar cells based on hybrid lead halide perovskites (26.1%) has become equal to that of a single-crystalline silicon photovoltaic cell. [1] Nevertheless, there are two insurmountable problems for practical usage of halogenoplumbates(II) in photovoltaics: high toxicity of lead(II) and low stability of compounds. The most promising analogues without these disadvantages are the organic-inorganic halide complexes of antimony(III) and bismuth(III). [2] However, unlike lead compounds, hybrid metal(III) halides have significantly larger band gaps due to the smaller dimensions of the anionic substructures. This, in turn, determines lower values of the maximum theoretical efficiency of solar cells based on Bi(III) and Sb(III). [3] Therefore, the main challenge of lead-free photovoltaics today is the development of approaches to tuning the crystal structure to reduce the bandgap values.

For hybrid antimony(III) and bismuth(III) halides, we have proposed the incorporation of polyhalide fragments into the crystal structure as a way to the bandgap narrowing. In this case,  $X_2$  molecules ( $X = I, Br$ ) or  $(I)_n^-$  anions, due to the formation of halogen bonds, combine discrete metal halide anions into substructures of the higher dimension.  $np-X$  polyhalide states build minima of the conduction band or maxima of the valence band, depending on the nature of a metal, which leads to a decrease of the bandgap of metal(III) polyhalides.

In this work, we apply diprotonated cyclic aliphatic amines – homopiperazinium ( $HpipeH_2^{2+}$ ) and piperazinium ( $PipeH_2^{2+}$ ), – as organic cations, which form  $N-H \cdots X$  hydrogen bonds and serve as “structure-directing agents.” By varying the synthesis conditions, it was shown that both in acidic aqueous solutions and in non-aqueous media, the selected cations form a number of characteristic metal(III) halide anions: discrete mononuclear  $[MX_6]^{3-}$  and binuclear  $[M_2X_{10}]^{4-}$ , as well as 1D polymer  $\{Ml_4\}^-$  ( $M = Sb, Bi$ ). A decrease in the organic cation/ $MX_3$  ratio and/or a decrease in the concentration of an aqueous solution of  $HX$  leads to an increase in the degree of condensation of  $MX_6$  octahedra in complex anions, which is accompanied by a decrease in the bandgap from 2.3 to 2.0 eV in the case of metal(III) iodides. The use of cation polyiodides as precursors or an addition of  $X_2$  to the reaction mixture made it possible to specifically incorporate polyhalide fragments into the structure. Along with the formation of discrete  $[Ml_6]^{3-}$  octahedra, the formation of isolated  $(I_3)^-$  anions is observed. In the case of discrete  $[M_2X_{10}]^{4-}$  anions, bridging  $X_2$  molecules link them into the  $\{[M_2X_{10}](X_2)\}^{4-}$  pseudochain due to the formation of weak  $X \cdots X$  bonds (figure 1). It leads to the decrease in the bandgap of  $(Hpipe)_2\{[Sb_2I_{10}](I_2)\}$  down to 1.41 eV [4].

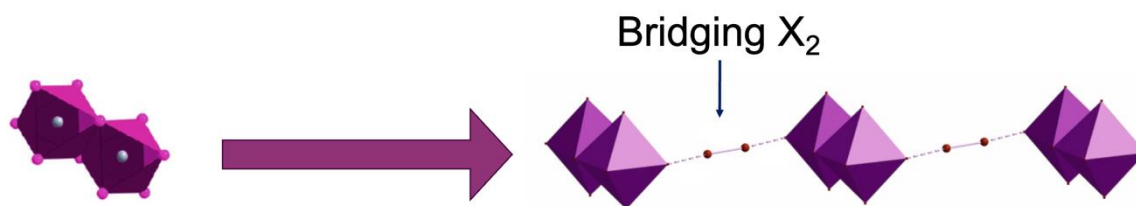

**Figure 1.** Formation of  $\{[M_2X_{10}](X_2)\}^{4-}$  pseudochain in  $(Hpipe)_2\{[M_2X_{10}](X_2)\}$ .

## References

- [1] *NREL* **2024**, URL: <https://www.nrel.gov/pv/cell-efficiency.html>
- [2] *Adv. Sci.* **2020**, 7(13), 1903143
- [3] *ChemSusChem* **2019**, 12(8), 1612-1630
- [4] *Int. J. Mol. Sci.* **2023**, 24(3), 2201

## Acknowledgements

This work was funded by the Russian Foundation for Basic Research (grant No. 21-53-50007).

# EVALUATION OF THE FLiNAK MELT STRUCTURE BASED ON ELECTRONIC ABSORPTION SPECTRA

Chernyshev S.V.<sup>1</sup>, Vlasov M.I.<sup>1</sup>

<sup>1</sup> Institute of High Temperature Electrochemistry, Yekaterinburg, Russia

Postgraduate student

[chernishov@ihte.ru](mailto:chernishov@ihte.ru)

One of the most crucial aspects of nuclear energy advancement involves the design and creation of a molten salt reactor [1] and the pyrochemical processing of spent nuclear fuel [2]. In both these endeavors, high-temperature melts of alkali and alkaline earth halides are used.

The electronic molar absorption spectra of Nd(III) and Ce(III) ions in mixtures of FLiNaK–(2 mol.%)NdF<sub>3</sub>–(2, 32 mol.%)CeF<sub>3</sub> and FLiNaK–(2 mol.%)NdF<sub>3</sub>–(2, 32 mol.%)LaF<sub>3</sub> by transmittance-reflectance setup in the spectral range of 330–950 nm at 1140 and 1300 K were obtained (Fig. 1, a). A cylindrical platinum crucible was used as the container for melting the salts, while a polished platinum-rhodium plate served as the reflector. Salt samples were loaded into the crucible in a glove box, followed by heating in an induction furnace in an argon atmosphere (the moisture and oxygen content did not exceed 0,1 ppm). The thickness of the molten layer above the reflector did not exceed 2,1 mm.

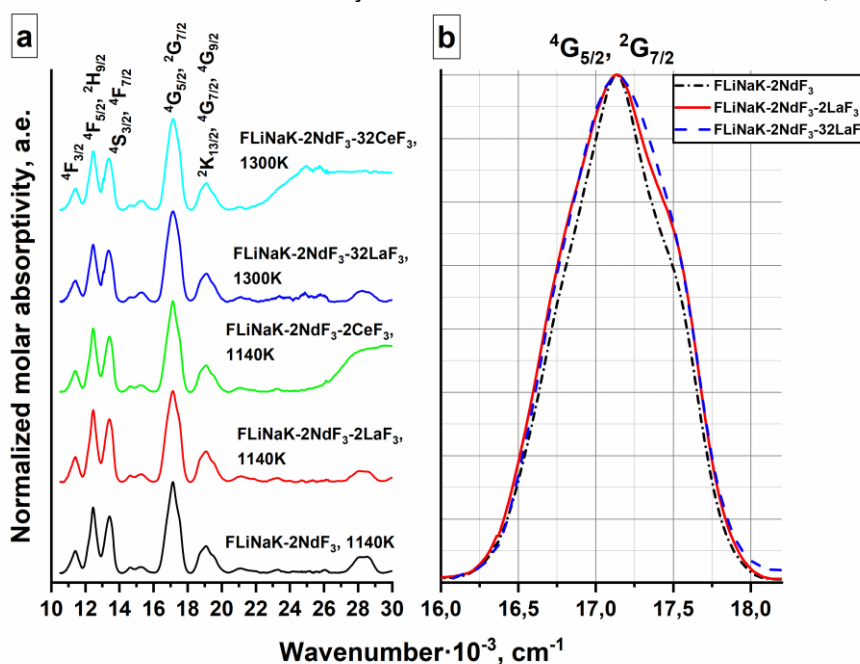

**Figure 1.** a is electronic molar absorption spectra of rare earth ions in the FLiNaK melt at 1140 and 1300 K, b is the region of the  $^4G_{5/2}$  hypersensitive transition for FLiNaK-2NdF<sub>3</sub>-(2,32)LaF<sub>3</sub> mixtures.

The predominant contribution to all the observed absorption bands of neodymium ions arises from the induced electric dipole transitions from excited states to the ground state  $^4I_{9/2}$ , except for the bands  $^2H_{9/2}$  and  $^4G_{9/2}$  with minor contributions from magnetic dipole transitions. The highest intensity of molar absorption of Nd<sup>3+</sup> ions in the FLiNaK melt corresponds to the hypersensitive transition  $^4G_{5/2}$  [3]. A broadening of this band is observed as the content of both LaF<sub>3</sub> (Fig. 1, b) and CeF<sub>3</sub> increases. The intensity of the transitions  $^4F_{5/2}$ ,  $^2H_{9/2}$  and  $^4S_{3/2}$ ,  $^4F_{7/2}$  is comparable to the intensity of the hypersensitive transition, which is not typical for chloride melts [4, 5].

An assessment of the structural features of the FLiNaK melt was made based on the calculated oscillator strengths of hypersensitive transitions, as well as the Judd-Ofelt parameters.

## References

- [1] *Annals of Nuclear Energy*. **2022**, 169, 108924
- [2] *Energy Procedia*. **2011**, 7, 431
- [3] *Organometallics of the f-Elements*. **1979**, 44, 281
- [4] *Journal of Molecular Structure*. **2006**, 782, 130
- [5] *Radiochimica Acta*. **1997**, 78, 91



# ALKYNYL GOLD(I) COMPLEXES WITH D- $\pi$ -A LIGANDS: SYNTHESIS AND PHOTOPHYSICAL PROPERTIES

*Ekaterina Dracheva, Paderina A.V., Luginin M.E., Snetkov D.A.*

St. Petersburg State University, St. Petersburg, Russia

Student

[st097976@student.spbu.ru](mailto:st097976@student.spbu.ru)

Alkynyl complexes of Au(I) are of great interest to researchers due to their photophysical properties, which find applications in a wide variety of research areas, namely: in optoelectronics[1], catalysis, bioimaging, as anticancer agents and chemosensors [2]. The luminescent properties of Au(I) complexes depend on the nature of the ligand environment.

In the present work, two series of Au(I) complexes were synthesized on the basis of D- $\pi$ -A alkynyl ligands: heteroleptic phosphine alkynyl complexes[3] and homoleptic bis-alkynyl compounds[4]. The C $\equiv$ C triple bond acts as the donor group of the alkynyl ligand, while phosphine oxide possesses the acceptor properties. The coordination of alkynyl ligands to a metal results in a system with intramolecular charge transfer.

It was found that the luminescent properties of all the obtained complexes are sensitive to the nature of the alkynyl ligand, i.e., to the linker length between the donor and acceptor sites. At the same time, the photophysical properties of the complexes do not change by varying the phosphine ligand in heteroleptic compounds. Homoleptic complexes show brighter photophysical properties in contrast to heteroleptic ones. At the same time, complexes from both series show brighter photophysical properties in the solid phase compared to solution.

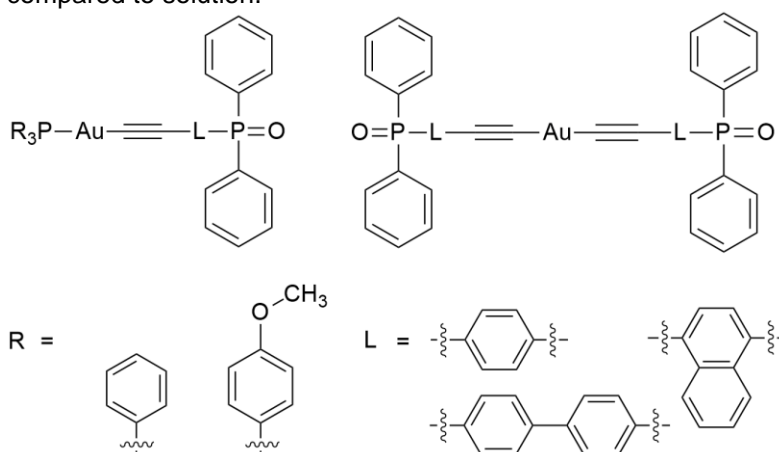

**Scheme 1.** Schematic structures of Au(I) complexes

## References

- [1] *Coordination Chemistry Reviews*, **2020**, 408.
- [2] *Coordination Chemistry Reviews*, **2020**, 423.
- [3] *Mol. Syst. Des. Eng.*, **2022**, 7, 1249-1262.
- [4] *Inorg. Chem.* **2023**, 62, 5123–5133.

## Acknowledgments

This work was supported by the Russian Science Foundation (project No 24-13-00024). The work was carried out using equipment of St Petersburg University Research Park (Centres of Magnetic Resonance, Chemical Analysis and Materials Research, Optical and Laser Materials Research and X-ray Diffraction Centre).

# HETEROANIONIC COMPLEXES OF REE'S WITH PENTAFLUOROBENZOIC AND 2,4,6-TRIMETHYLBENZOIC ACIDS AND AROMATIC N-DONOR LIGANDS

*L.M. Efremeev*<sup>1,2</sup>, *M.A. Shmelev*<sup>3</sup>, *S.S. Shapovalov*<sup>4</sup>, *E.A. Varaksina*<sup>5</sup>, *I.V. Taidakov*<sup>5</sup>, *A.A. Sidorov*<sup>1</sup>,  
*I.L. Eremanko*<sup>1</sup>

<sup>1</sup> Laboratory of Coordination Polymeric Compounds Chemistry, IGIC RAS

<sup>2</sup> HSE University, Faculty of Chemistry, Moscow, Russia

<sup>3</sup> Laboratory of Nanobiomaterials and Bioeffectors for Theranostics of Socially Significant Diseases, IGIC RAS

<sup>4</sup> Laboratory of Exchange Cluster Chemistry, IGIC RAS

<sup>5</sup> Lebedev Physical Institute, RAS

Student

[lmefremeev@edu.hse.ru](mailto:lmefremeev@edu.hse.ru)

The variation of non-covalent interactions allows for directed influence on the structure, chemical, and physical properties of substances and materials. This is particularly critical in the formation of polymeric structures of coordination compounds with aromatic ligands [1].

This study investigates the structure and photoluminescent properties of heteroanionic europium complexes with anions of pentafluorobenzoic acid (H<sub>pfb</sub>) and 2,4,6-trimethylbenzoic acid (H<sub>tMebz</sub>), with 1,10-phenanthroline (Phen) and 2,2'-bipyridine (2,2'-bipy) in methanol (MeOH), ethanol (EtOH), or a mixture of methanol with benzene (C<sub>6</sub>H<sub>6</sub>). A series of compounds with varying compositions were obtained:

- [Eu<sub>2</sub>(tMebz)<sub>2</sub>(pfb)<sub>4</sub>(Phen)<sub>2</sub>](MeOH)<sub>2</sub>
- [Eu<sub>2</sub>(tMebz)<sub>1</sub>(pfb)<sub>5</sub>(Phen)<sub>2</sub>](MeOH)<sub>2</sub>
- [Eu<sub>2</sub>(tMebz)<sub>0.8</sub>(pfb)<sub>5.2</sub>(Phen)<sub>2</sub>](MeOH)<sub>2</sub>
- [Eu<sub>2</sub>(tMebz)<sub>2</sub>(pfb)<sub>4</sub>(Phen)<sub>2</sub>](C<sub>6</sub>H<sub>6</sub>)<sub>2</sub>
- [Eu<sub>2</sub>(tMebz)<sub>1</sub>(pfb)<sub>5</sub>(2,2'-bipy)<sub>2</sub>]
- [Eu<sub>2</sub>(pfb)<sub>6</sub>(Phen)<sub>2</sub>](EtOH)<sub>2</sub>

The main structural motifs for all compounds are arene-perfluoroarene overlap systems and numerous H-F hydrogen bonds.

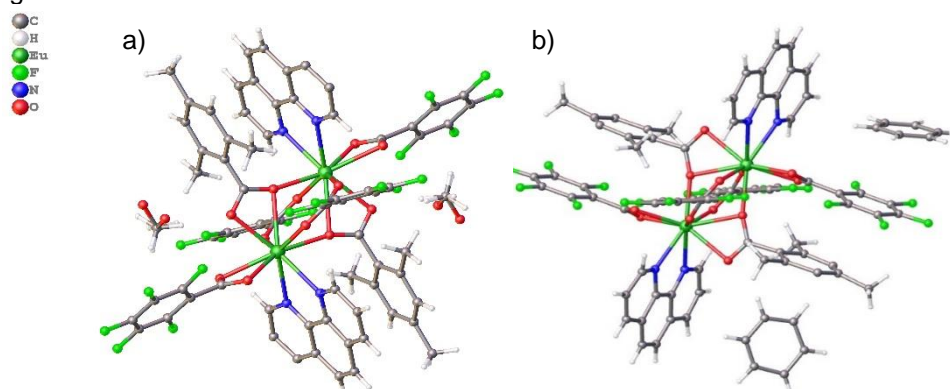

**Scheme 1:** Structure of compounds [Eu<sub>2</sub>(3Mebz)<sub>2</sub>(pfb)<sub>4</sub>(Phen)<sub>2</sub>](MeOH)<sub>2</sub> (a)  
[Eu<sub>2</sub>(3Mebz)<sub>2</sub>(pfb)<sub>4</sub>(Phen)<sub>2</sub>](C<sub>6</sub>H<sub>6</sub>)<sub>2</sub> (b).

Notably, using benzene changes the complex's geometry, resulting in triple-deck  $\pi \dots \pi$  interactions. Conversely, using the chelating 1,10-phenanthroline results in complexes where 3Mebz<sup>-</sup> anions are oriented relative to the 1,10-phenanthroline. The photoluminescent properties of the obtained REE complexes were studied, with the highest quantum yield observed for the molecular complex [Eu<sub>2</sub>(3Mebz)<sub>2</sub>(pfb)<sub>4</sub>(Phen)<sub>2</sub>](C<sub>6</sub>H<sub>6</sub>)<sub>2</sub>, which amounted to 38%, indicating a significant influence of crystalline packing stabilization due to  $\pi \dots \pi$  interactions.

## References

[1] *Materials*. **2020**, 13, 5689.

## Acknowledgements

This work was financially supported by the Russian Science Foundation (project number 22-73-10192).

# FLUORESCENT ACTIVITY AND BEHAVIOUR ESPECIALITIES OF SUBSTITUTED PHTHALOCYANINE COMPLEXES

*Erzunov D.A., Vashurin A.S.*

Kurnakov Institute of General and Inorganic Chemistry of RAS, Moscow, Russia  
[erzunov@igic.ras.ru](mailto:erzunov@igic.ras.ru)

Present days, the usage of intense fluorescence of molecules as a tool for visualization and improvement of optical properties is gaining increasing interest [1]. Such materials can be used as intensive lasers, in the field of solar energy, bioimaging, etc. Metal complexes of various nature have proven to be one of the promising types of compounds for these purposes. The presence of certain ligands in the composition of the compound can lead to a strong flare-up of the fluorescent properties [2]. Complexes of macrocyclic compounds are of particular interest in this regard [3]. Thus, the presence of a luminescent active metal ion and a structurally appropriate ligand in the complexes of macrocyclic compounds simultaneously leads to the partial removal of some forbidden transitions, providing extremely high yields of fluorescence quantum yields.

This paper summarizes the data on obtaining and studying the spectroscopic and fluorescent characteristics of substituted phthalocyanine metal complexes. Cyanophenoxy-, nitrophenoxy-, phenoxy- and phenylthia-, alkyloxy- and other fragments were used as substituents (Fig. 1). For all phthalocyanine derivatives, the values of fluorescence quantum yields in organic media were determined. The patterns of changes in spectroscopic properties and photophysical characteristics are shown when substituents of various natures are introduced, as well as when the nature of the bridge spacer fragment is replaced.

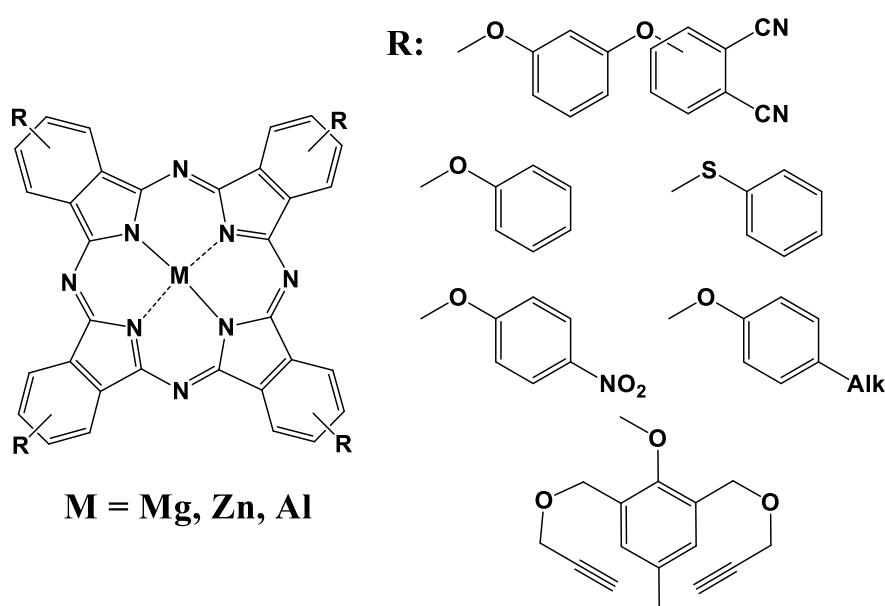

**Figure 1.** The structures of metal phthalocyanines studied.

## References

- [1] *Chem. Soc. Rev.* **2007**, 36, 993
- [2] *Chem. Rev.* **2007**, 107, 1831
- [3] *Chem. Rev.* **2011**, 111, 7941

## Acknowledgements

This work was supported by the Russian Science Foundation (project No 22-73-10158).

## SULFUR QUANTUM DOTS STABILIZED BY CATIONIC SUPRAMOLECULAR STRUCTURES

*Gaifullina E.T.<sup>1</sup>, Zarafutdinova Z.R.<sup>1</sup>, Gataullina R.M.<sup>1</sup>, Shmelev A.G.<sup>1</sup>, Kornev T.A.<sup>1,2</sup>, Nizameeva G.R.<sup>2</sup>, Ziyatdinova A.B.<sup>1</sup>, Amirov R.R.<sup>1</sup>*

<sup>1</sup> Kazan Federal University, Kazan, Russia

<sup>2</sup> Kazan Arbuzov's Institute, Kazan, Russia

Student

[annette\\_zb@mail.ru](mailto:annette_zb@mail.ru)

Nowadays quantum dots (QDs) arouse an increasing interest of scientists due to the ability to control the wavelength of emitted light. The search for new effective methods for producing quantum dots is an important task both for fundamental chemistry and from a practical point of view.

Particular attention is drawn to QDs based on nonmetals, including sulfur, which do not contain toxic heavy metal ions. The high antifungal and antibacterial activity and lack of cytotoxicity of sulfur nanoparticles gives promise for use in bioluminescent imaging and theranostics. In addition, the high sensitivity of sulfur QDs (SQDs) to the presence of d-metal ions enables the detection of trace amounts allowing their use in analytical purposes.

The capabilities of cationic amphiphilic compounds capable of forming supramolecular structures with regions of different polarity in aqueous solutions were tested as stabilizers of SQDs. The positive charge in such organized media additionally electrostatically retains negatively charged sulfur nanoparticles to obtain stable transparent solutions.

Preliminary experiments determined the sizes of sulfur particles (TEM, DLS) in micellar solutions of surfactants and polyelectrolytes. The following were tested as stabilizers for the synthesis of SQDs: tetradecyltrimethylammonium chloride (MTAB), polyethylenimine (PEI), and polydiallyldimethylammonium chloride (PDDC). The effectiveness of using different stabilizers was assessed based on measuring the photoluminescence intensity of SQDs. PEI and MTAB were found to be effective stabilizers for the preparation of SQDs.

In this work, SQDs were synthesized using two methods: using elemental sulfur and sodium thiosulfate as starting reagents. Both syntheses occur when heated to 70°C in an alkaline medium. When using elemental sulfur as a reagent, the synthesis takes 10-12 hours. When using sodium thiosulfate, the synthesis time is reduced to 4 hours. During the experiment, optimal conditions for obtaining QDs with high stable emission were found. The resulting compositions have prospects for use in medicine, cosmetology, and also as an antifungal agent for building materials.

It is known that SQDs are able to effectively bind d-metal ions, so it was of interest to test the effect of additions of cobalt(II) and copper(II) ions on the photoluminescent characteristics of SQDs. It was found that the addition of metal ions leads to photoluminescence quenching. In the case of PEI, a process of complexation with d-metal ions was observed, which competed with the process of binding of metal ions to SQDs.

### **Acknowledgements**

This work was supported by the Strategic Academic Leadership Program of the Kazan (Volga Region) Federal University ("Priority-2030").

# LACTATES AND PROPIONATES OF RARE EARTH ELEMENTS – SYNTHESIS, STRUCTURE AND APPLICATION FOR RARE EARTH NICKELATES FILMS DEPOSITION

*Gashigullin R.A.<sup>1</sup>, Kendin M.P.<sup>1,2</sup>, Tsybarenko D.M.<sup>2</sup>*

<sup>1</sup> Department of Material Sciences, Lomonosov Moscow State University, Moscow, Russia.

<sup>2</sup> Department of Chemistry, Lomonosov Moscow State University, Moscow, Russia.

PhD Student

[tsybarenko@gmail.com](mailto:tsybarenko@gmail.com)

Rare earth orthonickelates ( $\text{LnNiO}_3$ ) have a distorted perovskite structure and, due to oxygen nonstoichiometry and the content of trivalent nickel, are promising for use in catalysis, sensors, as conductive layers, etc. One of the main properties of rare earth nickelates is the metal-semiconductor transition while temperature decreasing and vice versa - with pronounced hysteresis - explained by the charge transfer. The critical transition temperature primarily depends on the average radius of the cation in the Ln position. However, these features also cause the synthetic problems: the presence of trivalent nickel makes orthonickelates unstable at high ( $\sim 1100$  K) temperatures, oxygen nonstoichiometry leads to a great influence of the electrical resistance-temperature curve on the prehistory and morphology of the sample. Stabilization of the phase of rare earth orthonickelates is possible in the form of an epitaxial thin film on a coherent inert substrate. In this work, we develop a technique for chemical depositing thin films of rare earth nickelates from solutions. As starting materials, we used salts of propionic ( $\text{CH}_3\text{CH}_2\text{COOH}$ ) [1] and lactic ( $\alpha$ -hydroxypropionic) [2] acids. Ln and nickel coordination compounds were synthesized, and their composition, structure, and thermal behavior were studied. Rare earth lactates have the general formula  $\text{LnLact}_3 \cdot n\text{H}_2\text{O}$  ( $\text{Ln} = \text{La, Ce-Nd, Sm-Lu, Y}$ ;  $n = 2-3$ ) and several structural types of chain and molecular di- and monomer structure. It has been revealed that heating hydrates of the composition  $\text{LnLact}_3 \cdot 3\text{H}_2\text{O}$  (for  $\text{Ln} = \text{La-Nd}$ ) leads to the complete elimination of water molecules in one stage and the formation of amorphous anhydrous compounds. At the same time, for  $\text{Ln} = \text{Sm-Lu}$  and Y, dehydration occurs in two stages with the formation of an intermediate crystalline dihydrate  $\text{LnLact}_3 \cdot 2\text{H}_2\text{O}$  of orthorhombic symmetry. Moreover, some  $\text{LnLact}_3 \cdot 2\text{H}_2\text{O}$  phases occur at elevated temperatures or from non-water solutions. For  $\text{Ln} = \text{La-Sm}$ , rare earth lactates and propionates (with the general formula  $\text{LnProp}_3 \cdot x\text{H}_2\text{O} \cdot y\text{HProp}$ ) were used to form gels with amines (mostly diethylenetriamine) and anhydrous nickel lactate. From the gels solutions in isopropanol,  $\text{LnNiO}_{3-\delta}$  films were deposited onto single-crystal substrates (001) $\text{LaAlO}_3$ , (001) $\text{SrTiO}_3$  and substrate tapes  $\text{LaMnO}_3/\text{MgO}/\text{HC276}$  (nickel alloy). The films were characterized by atomic force microscopy, X-ray diffraction and the temperature dependence of electrical resistance.

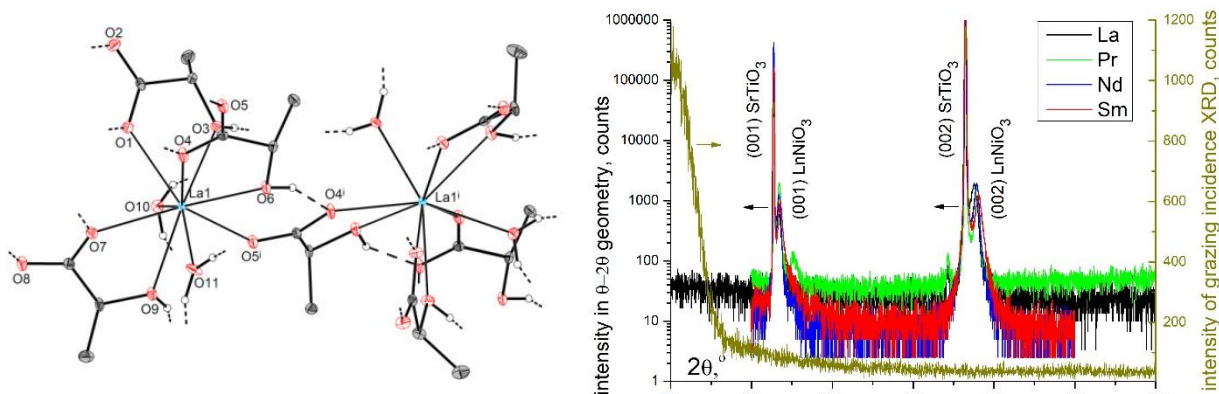

**Scheme 1.** A fragment of  $\text{La}_2\text{Lact}_6(\text{H}_2\text{O})_5 \cdot \text{H}_2\text{O}$  structure (left); XRDs of  $\text{LnNiO}_3/\text{SrTiO}_3$  films (right).

## References

- [1] *Russ. J. Inorg. Chem.* **2023**, *68*, 1263–1272
- [2] *Molecules.* **2023**, *28*, 5896.

## Acknowledgements

This work was supported by the Russian Science Foundation (project №22-73-10089).

# RATIONAL DESIGN OF NEW HETEROMETALLIC YTTRIUM-BASED COMPLEXES AS PROSPECTIVE ANTIPROIFERATIVE AGENTS

Gavrikov A.V.<sup>1</sup>

<sup>1</sup> Kurnakov Institute of General and Inorganic Chemistry of the Russian Academy of Sciences, Moscow, Russia

PhD

[penguin1990@yandex.ru](mailto:penguin1990@yandex.ru)

Currently, cancers provide considerable contributions to the people's mortality all over the world. Such a situation arises from many factors such as steady progression of these deceases, and acquired drug resistance of tumors. Thus, the continuous elaboration of new agents with a selective effect on tumor cells is of obvious necessity. As such agents, coordination compounds are of interest because of the capability to tune their bioactivity by combining bioactive  $M^{n+}$  cations with appropriate core-forming and auxiliary ligands. In these cases, a certain synergism of anticancer activity along with selective toxicity can be achieved for resulting compound [1]. Moreover, these features can be further enhanced if several types of cations are involved. However, the ongoing elaboration of heterometallic complexes is accompanied by considerable difficulties because of crucial requirement to solubility in living systems based on  $H_2O$ . This results in a general scarcity of studies involving complexes formed by rare earth elements (including yttrium) and d-metals. The second hindrance in this field is associated with the necessity of establishing components formed in diluted aqueous solutions in order to reveal components and interactions responsible for anticancer activity.

With this in mind, we prepared a series of simple ionic complexes, namely  $[M(L)_3][Y(NO_3)_5]$  with  $L = 2,2'$ -bipyridine/bpy (**1-3**), and 1,10-phenanthroline/phen (**4-6**), and  $M = Co$  (**1, 4**),  $Ni$  (**2, 5**),  $Zn$  (**3, 6**). The structures of complexes are shown on Figure 1. The sufficient solubility of **1-6** in water allowed to perform comparative *in vitro* study of their anticancer activity on several cancer cell lines, namely glioblastoma (*T98G*), renal cancer (*Проч-1-KK*), cutaneous melanoma (*Me1 IS*), breast cancer (*HBL-100*) and its doxorubicin-resistant subline (*HBL-100/Dox*). As a reference, normal skin fibroblasts (*PBK*) line was involved in this study. Mechanisms of cell death were revealed. The unequal toxicity of complexes **1-6** is discussed in the light of their transformations in diluted (0.5-4  $\mu g/ml$ ) aqueous solutions studied by  $^1H$  NMR, ionometry and ion chromatography. As a result of such study,  $M/L/Y$  combinations were revealed which show high and selective toxicity thereby being prospective for further *in vivo* investigations. Noteworthy, **1-6** represent the first series of yttrium-containing complexes with unambiguously demonstrated anticancer activity.

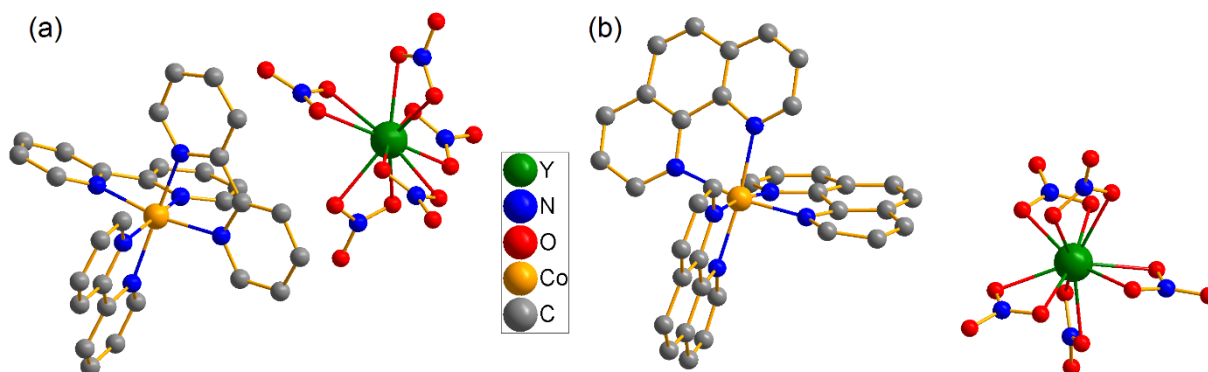

**Figure 1.** Structure of the formula unit of **1** (a) and **2** (b). Hydrogen atoms are omitted for clarity.

## References

[1] *Coord. Chem. Rev.* **2021**, *445*, 214088

## Acknowledgements

This work was supported by the Russian Science Foundation (project No 23-23-00601).

# INTERACTION OF $E(C_6F_5)_3 \cdot Et_2O$ ( $E=Al-In$ ) with $ICl$ : COMPETITION OF COMPLEXATION AND DECOMPOSITION.

*Glukhovich E.V., Kazakov I.V.*<sup>1</sup>

<sup>1</sup> St. Petersburg State University, St. Petersburg, Russia

Student

[e7188@mail.ru](mailto:e7188@mail.ru)

Tris(pentafluorophenyl) derivatives of group 13 elements exhibit strong Lewis acid properties, enabling them to interact with bases of varying strengths. For instance, complexes of  $E(C_6F_5)_3$  ( $E=B-In$ ) with pyridine [1], acetonitrile [2], and diethyl ether [3] have been structurally characterized. The interaction of interhalogens, known as weak Lewis bases, with these strong Lewis acids has garnered significant interest in the field of synthetic chemistry.

In this study, we synthesized complexes of group 13 element tris(pentafluorophenyl) derivatives  $E(C_6F_5)_3$  ( $E=Al-In$ ) with diethyl ether, followed by their reaction with  $ICl$ . The adducts  $E(C_6F_5)_3 \cdot Et_2O$  ( $E=Al-In$ ) were obtained by reacting  $C_6F_5MgBr$  Grignard reagent in  $Et_2O$  with a toluene solution of  $ECl_3$  ( $E=Al-In$ ). The compounds were purified through recrystallization. Subsequent interactions of  $E(C_6F_5)_3 \cdot Et_2O$  ( $E=Al-In$ ) with  $ICl$  were carried out in  $CCl_4$ , resulting in a color change from dark to light pink. Characterization of the products was performed using NMR spectroscopy and mass spectrometry.

The liquid reaction mixture was subjected to mass spectrometry, where evaporation in the temperature range of 50-300 °C revealed the presence of  $C_6F_5I^+$  and  $E(C_6F_5)_2Cl^+$  ( $E=Al-In$ ) ions in the mass spectrum. This suggests the existence of  $E(C_6F_5)_2Cl \cdot Et_2O$  ( $E=Al-In$ ) and  $C_6F_5I$  in the analyzed solutions. NMR spectroscopy was conducted on the initial adduct with diethyl ether, the solution post-interaction with  $ICl$ , and the solution after evaporation of volatile components and dissolution of residue in  $CCl_4$ . Changes in the  $^{19}F\{H\}$  NMR spectra (Figure 1) in the latter two cases indicate successful reactions, with the absence of the  $C_6F_5I$  peak in the spectrum after evaporation, signifying its removal.

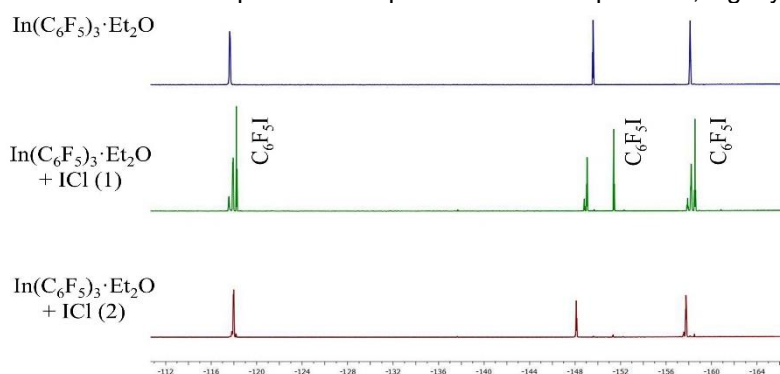

**Figure 1.**  $^{19}F\{H\}$  NMR spectra of solutions in  $CCl_4$  ( $d_8$ -toluene as internal standard):  $In(C_6F_5)_3 \cdot Et_2O$  (top), reaction mixture  $In(C_6F_5)_3 \cdot Et_2O + ICl$  (middle), reaction mixture  $In(C_6F_5)_3 \cdot Et_2O + ICl$  after removing volatiles (bottom).

Based on experimental observations, it can be concluded that interaction of  $E(C_6F_5)_3 \cdot Et_2O$  ( $E=Al-In$ ) with  $ICl$  in  $CCl_4$  at room temperatures results in formation of the  $C_6F_5I$  and  $E(C_6F_5)_2Cl \cdot Et_2O$  ( $E=Al-In$ ). In our opinion, reaction can be given by equation:

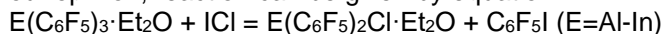

Thus, the reaction of  $E(C_6F_5)_3$  ( $E=B-In$ ) derivatives with interhalogens can be a convenient method for the synthesis of  $E(C_6F_5)_2X$  ( $E=B-In$ ) halogen derivatives, which can be useful starting materials for the preparation of new unsymmetrical Lewis acids based on bispentafluorophenyl derivatives of group 13 elements.

## References

- [1] *J. Organomet. Chem.*, **2021**, 948
- [2] *Z. Anorg. Allg. Chem.*, **2020**, 646, 13
- [3] *Eur. J. Inorg. Chem.*, **2020**, 2020, 47

## Acknowledgements

This work was financially supported by the Russian Science Foundation grant 23-13-00314. The work was carried out using equipment of the resource centers of St. Petersburg State University "Centre for Magnetic Resonance".

NEW IODATE FLUORIDES WITH GENERAL COMPOSITION  $M^I\text{Ce}(\text{IO}_3)_{6-x}\text{F}_x$   
( $M^I$  = alkali metal,  $x = 0 - 3$ ).

*Grigorieva O.P.*<sup>1</sup>,

<sup>1</sup> Moscow State University, Moscow, Russia

Postgraduate Student

[oksankagrigorevaa@mail.ru](mailto:oksankagrigorevaa@mail.ru)

In the recent decades, metal iodates receive increasing attention due to both their unique structures and the promise of their use as nonlinear optical crystals to expand the ranges of solid-state lasers from infrared (IR) to ultraviolet (UV) regions [1, 2]. The iodate anions exhibit strongly stereochemically active lone electron pairs which are believed to underpin the formation of non-centrosymmetric structures, a necessary condition for the occurrence of nonlinear optical properties, including second optical harmonic (SHG) generation. The easily polarizable I - O bonds contribute to the strong SHG response and do not exhibit absorption in a wide IR range, including the two important atmospheric windows (3-5 and 8-12  $\mu\text{m}$ ) [3]. It is also established that some of the oxygen atoms in these phases can be replaced by fluorine atoms with the formation of mixed-anionic metal fluoriodates, as well as fluoride iodates. This enhances formation of essentially more diverse set of structural elements, and expands the range of optical transparency. On the other hand, this results in compounds with wider band gap, a necessary for the high resistance to laser radiation, as expected for e.g. rare earth iodates. The main contribution to the final SHG signal of the phases under consideration is made by the iodate groups,  $\text{IO}_3$ , while that of the irregular metal polyhedra is smaller. It can be enhanced by formation of polycationic metal sublattices.

In this work, we searched for new iodate fluorides of the general composition  $M^I\text{Ce}(\text{IO}_3)_{6-x}\text{F}_x$  ( $M^I$  = alkali metal,  $x = 0 - 3$ ). A single compound of the like,  $\text{Li}_2\text{Ce}(\text{IO}_3)_4\text{F}_2$ , has been hitherto reported [4]. In our studies, rubidium and cesium compounds were targeted, which so far resulted in successful synthesis of two new target compounds,  $\text{Rb}_2\text{Ce}(\text{IO}_3)_5\text{F}$  (**1**) [5] and  $\text{Cs}_2\text{Ce}(\text{IO}_3)_6$  (**2**).

Preparations were made by a hydrothermal method in 18 ml autoclaves with a Teflon or parapolyphephenol liner, using MF ( $M = \text{Rb}, \text{Cs}$ ),  $\text{CeO}_2$ ,  $\text{H}_5\text{IO}_6$ ,  $\text{HIO}_3$ ,  $\text{H}_2\text{O}$  as starting components. The process was carried out at a temperature of 230 °C for 120 hours, followed by slow cooling to 207 °C, then to room temperature. The final solid products, which included transparent and colored (orange, green, light yellow) crystals, were filtered, washed with distilled water and air dried under mild heating. According to the XRD results, **1** crystallizes in the space group  $Cmc2_1$  with unit cell parameters  $a = 11.1518(6)$  Å,  $b = 8.1187(4)$  Å and  $c = 17.1581(10)$  Å, while **2**, in space group  $C2/c$ , with  $a = 14.0762(10)$  Å,  $b = 8.1868(5)$  Å,  $c = 17.7177(12)$  Å,  $\beta = 103.642(7)^\circ$ . In the structure of both new compounds,  $\text{Ce}^{4+}$  cations center eight-vertex polyhedra, comprised of only oxygen atoms (a distorted tetragonal antiprism) in **2**, and a mixed-anionic antiprisms  $\text{CeO}_7\text{F}$  in **1**. The  $\text{CeO}_8$  oxide polyhedra in **1**, share edges and vertices with the iodate groups to form layers parallel to the ( $ab$ ) plane. The  $\text{VCs}^+$  cations reside in the interplanar space. Their polyhedra (CN = 12) share faces forming layers parallel to ( $ac$ ) completing the framework. There are two types of crystallographically independent rubidium atoms in **1** which are characterized by CN = 7; one is "purely oxygen",  $\text{Rb}(1)\text{O}_7$ , while the other is mixed-anionic,  $\text{Rb}(2)\text{O}_6\text{F}$ . Sharing edges, these polyhedra form chains which share other edges and vertices with the  $\text{CeO}_7\text{F}$  polyhedra, forming layers further linked by the iodate groups into a three-dimensional framework. **1** is SHG active, with the signal comparable to the  $\text{KH}_2\text{PO}_4$  reference. According to DFT calculations, **1** is a semiconductor with a band gap of 2.33 eV. The new compounds are thermally stable in air up to 400 °C.

Our results, together with the reference data on  $\text{Li}_2\text{Ce}(\text{IO}_3)_4\text{F}_2$ , permit to suggest existence of a wider family of compounds with the general formula  $M^I\text{Ce}(\text{IO}_3)_{6-x}\text{F}_x$ .

## References

- [1] *J. Am. Chem. Soc.* **2018**, 140, 8868–8876
- [2] *Angew. Chem. Int. Ed.* **2019**, 58 11666–11669
- [3] *Chin. J. Struct. Chem.* **2023**, 42, 100014
- [4] *Cryst. Growth Des.* **2020**, 20, 4, 2135–2140
- [5] *Dalton Trans.* **2024**



# TETREL INTERACTIONS IN IRIDIUM(III) XYLYLISOCYANIDE COMPLEXES

Gusak M. Yu.<sup>1</sup>, Kinzhalov M.A.<sup>1</sup>

<sup>1</sup>St Petersburg University, St. Petersburg, Russia  
Student  
[st094961@student.spbu.ru](mailto:st094961@student.spbu.ru)

Tetrel bonds (TC), a non-covalent interaction, occur between group 14 elements and nucleophilic particles. These interactions are relatively poorly studied compared to other types of non-covalent bonds.[1] The interest in studying these bonds with CH<sub>3</sub> groups stems from their abundance in biological systems and their involvement in the initial stages of organic reactions that proceed according to the S<sub>N</sub>2 mechanism.[2]

In this work Iridium(III) complexes with the formula [IrX<sub>3</sub>(CNXyl)<sub>2</sub>(THT)] (X = Cl, Br; THT = tetrahydrothiophene; Xyl = C<sub>6</sub>H<sub>3</sub>-2,6-Me<sub>2</sub>) have been synthesized. In the crystal structures of these complexes, shortened interatomic distances were observed between the carbon atoms of the CH<sub>3</sub> group and the halogen atoms. The geometry of these intermolecular contacts corresponds to TC (Nc = d/∑<sub>vdW</sub> = 0.99–1.00, ∠(C–CH<sub>3</sub>···X) = 171.6–175.2)

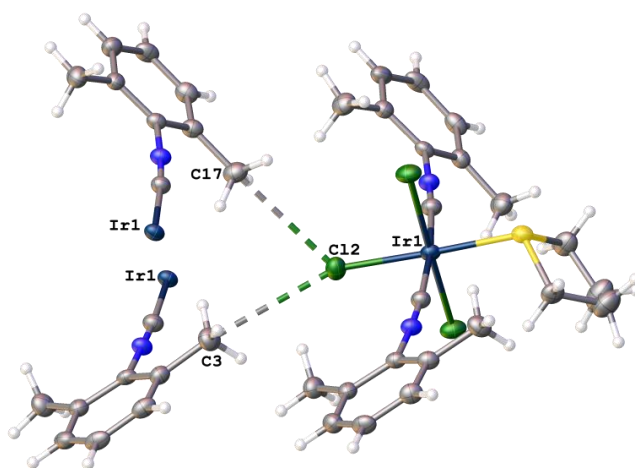

**Figure 1.** Supramolecular structure of [IrCl<sub>3</sub>(CNXyl)<sub>2</sub>(THT)] according to the X-ray diffraction analysis, the contacts of C<sub>Me</sub>···Cl are highlighted with a dotted line. Only one of the three molecules is shown [IrCl<sub>3</sub>(CNXyl)<sub>2</sub>(THT)] (on the right), and for the other two molecules, only [Ir]–CNXyl fragments are shown (on the left).

The results of the work were used to publish the preprint ([doi.org/10.26434/chemrxiv-2023-c118j](https://doi.org/10.26434/chemrxiv-2023-c118j)).

## References

- [1] *Angew. Chem. In. Ed.*, **2013**, 52, 12317.  
[2] *Phys. Chem. Chem. Phys.*, **2014**, 16, 1824.

## Acknowledgements

This work was supported by a grant from the Ministry of Science and Higher Education of the Russian Federation for large-scale research projects in high priority areas of scientific and technological development (grant number 075-15-2024-553). Measurements were performed in the Research Park at St. Petersburg University (the resource centers CMR, CXDS, CCAMR and CC).

## INTERMOLECULAR PNICTOGEN BONDING WITH METALS

*Ivanov D.M.*<sup>1</sup>

<sup>1</sup> St. Petersburg State University, Institute of Chemistry, St. Petersburg, Russia  
PhD, Senior Researcher  
[d.m.ivanov@spbu.ru](mailto:d.m.ivanov@spbu.ru)

Pnictogen bonding (PnB) is analog of halogen bonds with pnictogen electrophilic sites, which was recently defined by IUPAC [1]. In most cases, PnBs involve nonmetallic nucleophiles. Nevertheless, a number of intramolecular [2] and interionic [3] metal-involving PnBs were recently described. In this work, we present the examples of intermolecular the intermolecular X–Sb⋯Pt (X = Cl, Br, I) PnBs (Fig. 1, A), which were found cocrystals of *trans*-[PtX<sub>2</sub>(NCNR<sub>2</sub>)<sub>2</sub>] (R<sub>2</sub> = Me<sub>2</sub>, X = Cl, Br, I; R<sub>2</sub> = (CH<sub>2</sub>)<sub>5</sub>, X = I) with SbCl<sub>3</sub>, SbBr<sub>3</sub>, and SbI<sub>3</sub> by single-crystal XRD experiments and further confirmed by DFT calculations.

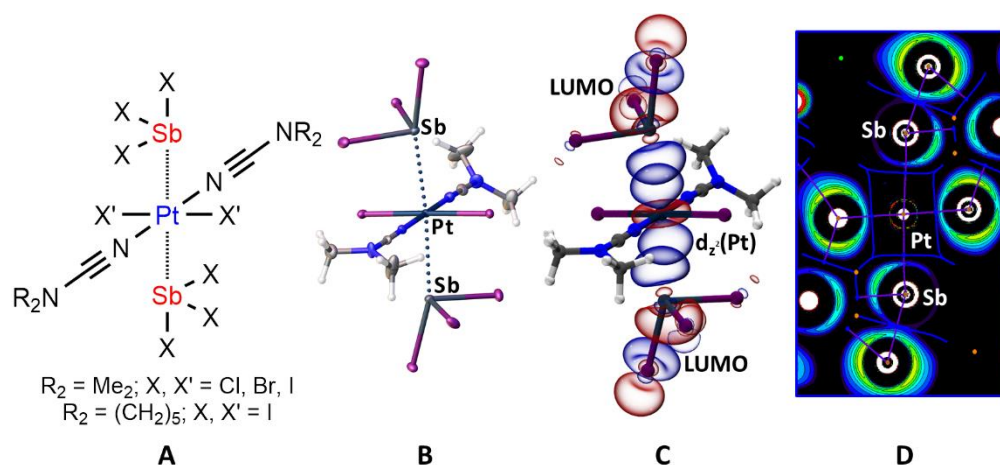

**Fig. 1.** Common view of X–Sb⋯Pt pnictogen bonds (A), the I–Sb⋯Pt pnictogen bonds in *trans*-[PtI<sub>2</sub>(NCNMe<sub>2</sub>)<sub>2</sub>]·2SbI<sub>3</sub> (B), superimposition of frontier orbitals on heterotrimer with the same bonds (C), and one-electron potential projection for the same bonds with QTAIM topological analysis in crystal model with periodic boundary conditions (D).

### References

- [1] *Pure Appl. Chem.* **2024**, *96*, 135
- [2] *Angew. Chem. Int. Ed.* **2014**, *53*, 2633
- [3] *Inorganics* **2023**, *11*, 80

### Acknowledgements

The work was supported by the Russian Science Foundation (project 22-73-10021).

## CRYSTAL STRUCTURES AND THERMAL PROPERTIES OF POTASSIUM ACETATE AND SORBATE

*Kalle P.<sup>1</sup>, Churakov A.V.<sup>1</sup>, Kuzmina L.G.<sup>1</sup>, Bezzubov S.I.<sup>1</sup>*

<sup>1</sup>Institute of General and Inorganic Chemistry, Moscow, Russia

Junior researcher

[kalle@igic.ras.ru](mailto:kalle@igic.ras.ru)

Many potassium salts are important industrial compounds. Potassium salts of sorbic and acetic acids are used in food processing, industry, and medicine. Despite their widespread use, there is no data on the solid-phase structure of these simple compounds. Moreover, without knowledge of the crystal structure, it is impossible to understand the mechanisms of phase transitions, information about which is inconsistent in the case of acetate, and for sorbate was obtained only few years ago.

Using X-ray diffraction analysis, the crystal structures of potassium sorbate and acetate were studied for the first time (Scheme 1). It was shown that both compounds are 2D coordination polymers that form layered packings with alternating aliphatic and metal-oxygen regions. X-ray powder analysis at different temperatures in combination with differential scanning calorimetry and thermomicroscopy made it possible to unambiguously determine the number of polymorphs and the ranges of their existence.

Potassium sorbate at 156°C undergoes a phase transition associated with the disappearance of the interaction between the potassium cation and the double bond of the sorbic fragment. This leads to a destruction of translational symmetry perpendicular to the layers and a sharp increase in the distance between layers in the aliphatic region.

Potassium acetate forms three polymorphs. The high-temperature orthorhombic modification transforms into a monoclinic modification when the temperature drops to 156°C, and below 59°C, with the loss of the inversion center, the volume of the monoclinic cell increases eightfold. The reduction in symmetry is determined by the tilt angle of the acetate groups. In addition, the hydration-dehydration processes involving potassium acetate were investigated by DSC and X-ray technics. Three stable hydrates – the hemihydrate, sesquihydrate, and dihydrate – were structurally characterized by X-ray diffraction.

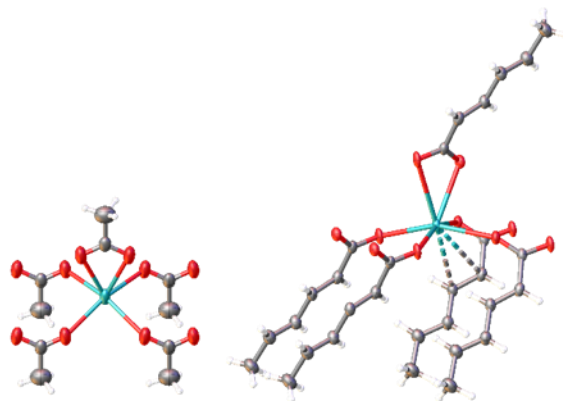

**Scheme 1.** Fragments of crystal structures of potassium acetate and sorbate.

In summary, this study reveals the structures and explains the thermal behavior of sorbate and potassium acetate including its hydrates.

### **Acknowledgements**

This work was supported by the Russian Science Foundation (project No 23-23-00208).

## SELF-REINFORCEMENT EFFECT IN THE PROCESS OF SYNTHESIS OF GYPSUM COMPOSITES BASED ON FLY ASH WITH A HIGH CONTENT OF FREE CALCIUM OXIDE

*Petropavlovskii K.S.<sup>1</sup>, Novicenkova T.B.<sup>1</sup>, Kalyaskin P.A.<sup>1</sup>, Sulman M.G.<sup>1</sup>, Petropavlovskaya V.B.<sup>1</sup>*

<sup>1</sup>Tver State Technical University  
Postgraduate  
[kaliaskinp@gmail.com](mailto:kaliaskinp@gmail.com)

The studies described in the work are devoted to the self-reinforcement of gypsum in the process of structure formation of the binder matrix. The development of the theory of hardening of gypsum composites provides a scientific basis for increasing performance characteristics and expanding the scope of their application. For example, in the field of 3D printing [1].

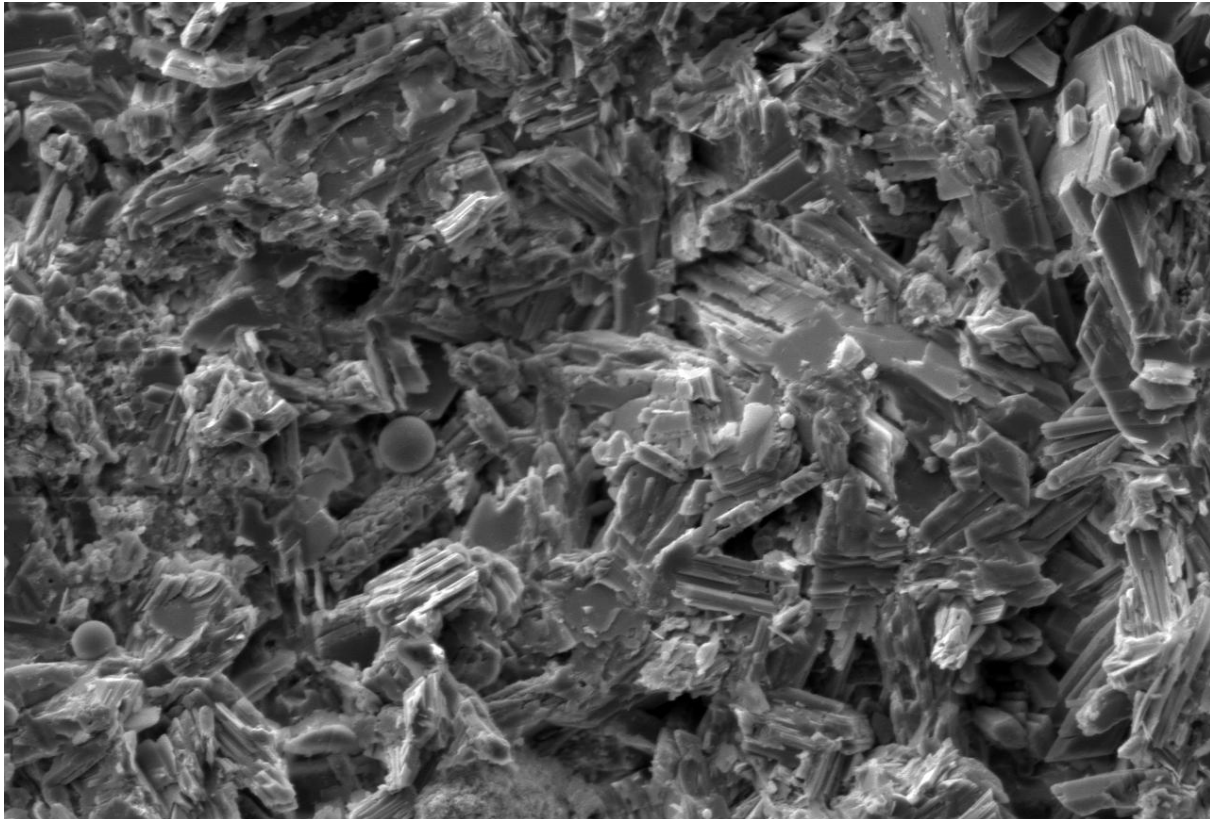

**Figure 1.** Structure of self-reinforced gypsum fly ash composite

The gypsum matrix, strengthened with crystals as a reinforcing element, is also the basis of structural materials. The use of fly ash with a high content of free calcium oxide increases the efficiency of the synthesis of composites [2].

### References

- [1] *The 8th Asian Symposium On Advanced Materials*, **2023**, 386-387
- [2] *Chemical Engineering Transactions* **2023**, 103, 769-774

### Acknowledgements

This work was supported by the Russian Science Foundation (project No. 21-79-30004).

# GREEN- AND BLUE-LIGHT HYDROSILYLATION PHOTOCATALYSIS WITH PLATINUM(II) METALLA-N-HETEROCYCLIC CARBENE COMPLEXES

*Kashina M.V.*<sup>1</sup>, *Luzyanin K.V.*<sup>2</sup>, *Kinzhalov M.A.*<sup>1</sup>

<sup>1</sup> St Petersburg University, St. Petersburg, Russia

<sup>2</sup> University of Liverpool, Liverpool, United Kingdom

PhD Student

[st040562.student@spbu.ru](mailto:st040562.student@spbu.ru)

Visible light-induced photocatalysis with the help of transition metal complexes has become a mainstay in organic synthesis.[1] Most of known catalytic systems of this type require blue light sources (400–450 nm) to initiate the photocatalytic reaction, which can lead to substrate destruction or undesirable secondary transformations. Photocatalytic systems operating under milder green irradiation demonstrated successful applications with Ir(III), Ru(II), and Cu(I) catalysts, but green-light Pt catalysis have never been reported. Recently, our group has described Pt complex incorporating metalla-*N*-heterocyclic carbene (MNHC, MNHCs – NHCs containing a metal atom within the NHC skeleton) ligands working as self-photosensitising photocatalyst of the hydrosilylation of alkynes under blue light.[2] Modification of the structure of this new Pt-MNHC catalytic species may impact on its light absorption properties to develop hydrosilylation photocatalytic systems working under green light.

A series of new Pt<sup>II</sup>-MNHC complexes was prepared *via* the nucleophilic addition of 2-aminoazines **7**–**10** to metal-bound isocyanides in *cis*-[MCl<sub>2</sub>(CNR)<sub>2</sub>] (**1**–**4**, M = Pd, Pt) (**Figure 1**).[3] The reaction proceeds under mild conditions in CH<sub>2</sub>Cl<sub>2</sub> at RT for *ca.* 1 d leading to binuclear Pt-MNHC species **12**–**23** in good isolated yields (84–95%). The **12**–**23**, **22** are yellow or yellowish solids, so they demonstrate light absorption up to 450 nm which are in visible light range. According to the TD DFT calculations and FMO analysis, the absorption nature is assigned to <sup>1</sup>L'LCT/<sup>1</sup>ILCT transitions, and are governed by the type of the azaheterocycle in MNHC fragment. The spectra of dark red compounds **21** and **23** show a broad absorption band extending to 510 nm in the green region of the visible spectrum. The results of IFCT method for **21** and **23** evidenced <sup>1</sup>L'LCT/<sup>1</sup>LMCT character of its long wavelength absorption.

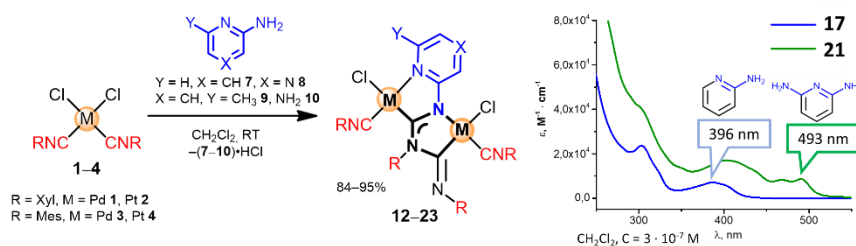

**Figure 1.** Synthetic route to **12**–**23** and UV-Vis absorption spectra for **17**, **21** (right).

Pt-MNHCs species (**13**, **15**, **17**, **19**, **20**, **23**) were examined as potential hydrosilylation photocatalysts in the reaction of diphenylacetylene with Et<sub>3</sub>SiH. Under blue irradiation ( $\lambda_{\text{max}} = 450$  nm) for 6–12 h. with a 0.1 mol% catalyst loading the highest catalytic efficiency was achieved with photocatalyst **17** (R = Mes, X = CH, 98%), indicating the effect of R substituent and azaheterocycle on the catalytic process. With green-light ( $\lambda_{\text{max}} = 500$  nm), yellow complexes exhibited no noticeable activity, while red diaminopyridine derivatives **21** and **23** led to 97–99% yield of *E*-1,2-(diphenylvinyl)triethylsilane. Ten-fold reduction of the catalyst loading for **23** (0.01 mol%) produced a negligible drop in activity (93%). Thus, we described the first photocatalytic system for hydrosilylation of alkynes based on Pt(II)-MNHC complexes operating under mild green light.

## References

- [1] *Enabling Catalytic Applications of Aminocarbene Ligands through Rational Design*, **2024**, 3.
- [2] *Chem. Commun.* **2018**, 54, 9450.
- [3] *Dalton Trans.* **2022**, 51, 6718

## Acknowledgements

This work was supported by the Russian Science Foundation (project No 24-23-00367). Measurements were performed in the Research Park at St. Petersburg University (the resource centres CMR, CXDS, CCAMR, CLMR, DCE and CC).

# INTRIGUING LATTICE DYNAMICS IN ALIPHATIC METAL CARBOXYLATES: PHASE TRANSITIONS AND ANOMALOUS THERMAL EXPANSION

*Kendin M.P.<sup>1</sup>, Shaulskaya M.D.<sup>1</sup>, Tsybarenko D.M.<sup>1</sup>*

<sup>1</sup> Moscow State University, Moscow, Russia

PhD Student

[kendin@inorg.chem.msu.ru](mailto:kendin@inorg.chem.msu.ru)

Crystalline solids exhibiting anomalous lattice dynamics—e.g., anisotropic or negative thermal expansion—represent significant interest as a versatile playground for the design of “smart” stimuli-responsive materials. In particular, metal propionates (Prop<sup>-</sup>) were reported to exhibit structural phase transitions, which are primarily driven by the thermally activated rotation of aliphatic groups. The present work reports an extensive crystallographic study of polynuclear and polymeric metal propionates with a primary focus on their thermally-driven lattice dynamics.

Within the rare-earth (RE, Ln) propionate system, a family of 2D-layered coordination polymers [Ln<sub>2</sub>(H<sub>2</sub>O)<sub>2</sub>Prop<sub>6</sub>]<sub>n</sub>, which consists of two distinct structural types (I – Ln=Ce, II – Ln=Ho–Lu, Y) has been revealed. As evidenced by powder- and single-crystal XRD, [Ce<sub>2</sub>(H<sub>2</sub>O)<sub>2</sub>Prop<sub>6</sub>] exists in the form of two polytypes ( $\alpha$  and  $\beta$ ), which differ from each other in the supramolecular arrangement of polymeric layers, the structure of these being identical for both structures. Given the pronounced crystallographic anisotropy of ( $\alpha,\beta$ )-[Ce<sub>2</sub>(H<sub>2</sub>O)<sub>2</sub>Prop<sub>6</sub>], both polytypes exhibit a highly anisotropic thermal expansion, which additionally proved to be strongly packing-dependent. Indeed,  $\alpha$ -[Ce<sub>2</sub>(H<sub>2</sub>O)<sub>2</sub>Prop<sub>6</sub>] demonstrate a non-monotonic temperature dependence of unit cell parameters with colossal positive (+899 MK<sup>-1</sup>) and negative (–427 MK<sup>-1</sup>) linear CTEs in the 190–210 K region (Fig. 1). On the contrary,  $\beta$ -[Ce<sub>2</sub>(H<sub>2</sub>O)<sub>2</sub>Prop<sub>6</sub>] exhibits a moderate positively defined thermal expansion with no pronounced anomalies in the 100–300 K range. Experimental data on the thermal expansion of ( $\alpha,\beta$ )-[Ce<sub>2</sub>(H<sub>2</sub>O)<sub>2</sub>Prop<sub>6</sub>] are discussed in terms of supramolecular interactions based on periodic DFT calculations [1]. Similarly, [Ln<sub>2</sub>(H<sub>2</sub>O)<sub>2</sub>Prop<sub>6</sub>] of type II (Ln = Ho–Lu, Y) were also shown to form two distinct polytypes, which proved to be interconvertible upon thermal and mechanical treatment [2].

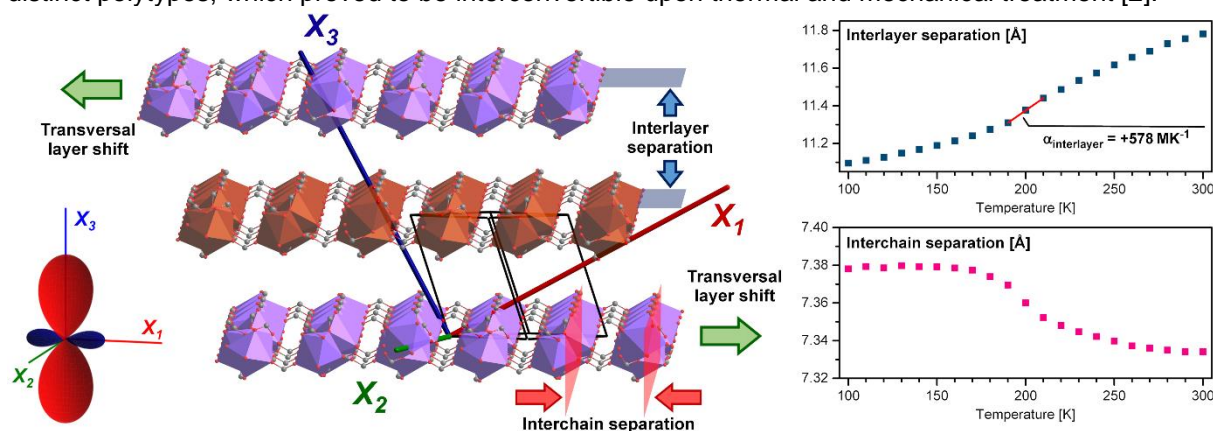

**Figure 1.** Colossal thermal expansion of  $\alpha$ -[Ce<sub>2</sub>(H<sub>2</sub>O)<sub>2</sub>Prop<sub>6</sub>] [1].

Among heterometallic propionates, a 3D-coordination polymer [HKCu<sub>2</sub>Prop<sub>6</sub>] has been characterized. As revealed from the variable-temperature powder and single-crystal XRD experiments, [HKCu<sub>2</sub>Prop<sub>6</sub>] undergoes a martensitic phase transition, which, however, makes no impact on the magnetic exchange magnitude within discrete [Cu<sub>2</sub>Prop<sub>4</sub>] “paddlewheels” ( $2J = -333(4) \text{ cm}^{-1}$ ) [3].

In summary, the present work reports a large family of structurally flexible crystalline solids that might shed light on the peculiar structure-property correlations among metal-organic systems.

## References

- [1] *Cryst. Growth Des.* **2024**, *24*, 1474
- [2] *Cryst. Growth Des.* **2020**, *20*, 3316
- [3] *Cryst. Growth Des.* **2021**, *21*, 6183

## Acknowledgements

This work was supported by the Russian Science Foundation (project No 22-73-10089). The authors acknowledge support from the M.V. Lomonosov Moscow State University Program of Development.

# EFFECT OF CRYSTAL PACKING ON THE OPTICAL PROPERTIES OF CYCLOMETALATED RHODIUM(III) AND IRIIDIUM(III) COMPLEXES WITH 1,3-DIKETONES

*Kiseleva M.A.<sup>1</sup>, Bezzubov S.I.<sup>1</sup>*

<sup>1</sup>Kurnakov Institute of General and Inorganic Chemistry, Russian Academy of Sciences, Russia  
Student

[marina.kiseleva@chemistry.msu.ru](mailto:marina.kiseleva@chemistry.msu.ru)

Bright luminophores and dyes based on iridium(III) complexes are highly valued by developers of modern high-tech devices such as organic light-emitting diodes (OLEDs) and solar cells due to their unique optical and electrochemical properties. Considering the fact that in optoelectronic and photovoltaic devices such complexes are in a solid (aggregated) state, it is necessary to establish relationships between the optical characteristics of compounds and the features of their organization in a solid. Moreover, it is of interest to study the influence of the central ion on the molecular packing features of cyclometalated complexes and, as a consequence, on the optical properties in solid form under the same ligand environment.

In line with this, the aim of the work was to disclose how weak intermolecular interactions affect the optical properties of iridium(III) and rhodium(III) complexes.

For this purpose, two similar sets of cyclometalated rhodium(III) and iridium(III) complexes with 2-phenylpyridine and various aromatic  $\beta$ -diketones were synthesized. The resulting compounds were characterized by <sup>1</sup>H NMR, high-resolution mass spectrometry, powder and single-crystal XRD. It was shown that 1,3-diketonate complexes form different crystal packings depending on the coordinated diketonate, while metal replacement does not significantly affect the packing. The  $\pi$ - $\pi$  stacking interactions between the pyridyl rings favor the formation of an emissive metal-to-ligand–ligand charge transfer state, resulting in the enhanced emission of the corresponding solid iridium(III) complexes compared with that in solution. In contrast, the isomorphous rhodium(III) complexes do not show detectable photoluminescence, which is very likely the result of the thermal population of the non-emissive d–d states. Moreover, the enhancement of the solid state emission of rhodium(III) cyclometalates can be achieved by assembling the molecules through  $\pi$ - $\pi$  stacking interactions between the metalated phenyl and pyridyl rings, as evidenced by the case of a rhodium(III) complex with ancillary benzoyltrifluoroacetone, which is the first example of a cyclometalated rhodium(III) complex exhibiting aggregation-induced emission [1]. Surprisingly, the observed solid-state emission of this rhodium(III) complex is caused by the same crystal packing peculiarities, resulting in the luminescence quenching of an isomorphous iridium(III) complex. The addition of water to the acetonitrile solutions of the complexes leads to suspensions demonstrating almost the same emission properties as the solid complexes. The rapid sedimentation of the suspensions and analysis of the SEM images of the precipitates suggest that the observed aggregates are formed by the same intermolecular interactions as the corresponding crystalline complexes.

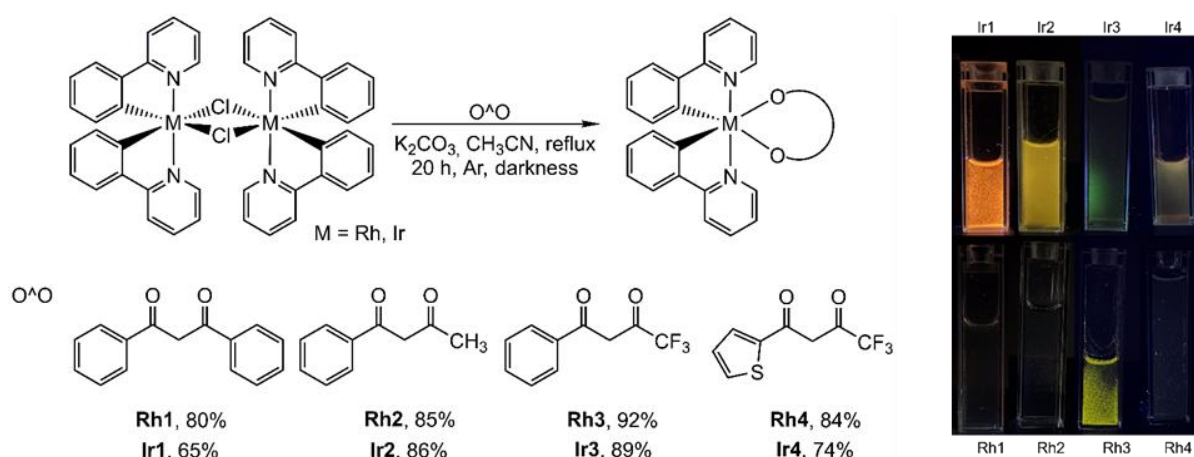

**Fig. 1.** Synthesis of cyclometalated complexes of rhodium(III) and iridium(III) (left) and luminescence photographs of the complexes in  $CH_3CN/H_2O$  (1/3) solution at 298 K ( $\lambda_{ex} = 365$  nm).

## References

[1] *Dalton Trans.* **2023**, 52(47), 17861–17872.

# SYNTHESIS AND PHYSICOCHEMICAL PROPERTIES OF O-BORYLATED CARBOXONIUM IONS

*Kolbunova A.V.*<sup>1,2</sup>, *Klyukin I.N.*<sup>1</sup>, *Zhizhin K.Yu.*<sup>1</sup>

<sup>1</sup> Kurnakov Institute of General and Inorganic Chemistry of the Russian Academy of Sciences, Moscow, Russia

<sup>2</sup> Moscow Institute of Physics and Technology (National Research University), Phystech School of Electronics, Photonics and Molecular Physics, Moscow Region, Dolgoprudny, Russia

Master's student

[zdimchi391@mail.ru](mailto:zdimchi391@mail.ru)

Carbocations are important intermediates in many reactions. The structure of carbocations defines the possible reaction pathways and the structure of products formed. Determination of their structure is often difficult due to their high reactivity, and they can be observed or isolated only in a non-nucleophilic medium. However, the reactivity of carbocations can be lowered by resonance stabilization of the cationic centre with one or several heteroatoms. One type of these cations is carboxonium ions which are resonance-stabilized by two oxygen atoms. These ions are often considered as intermediates in acid-catalyzed processes in carbonyl compounds.

In the present work, a novel type of stable carboxonium ions was obtained. The formation of borylated carboxonium ions is based on electrophile-induced nucleophilic substitution in polyhedral boron anions (we used  $[B_{12}H_{12}]^{2-}$  and  $[B_{10}H_{10}]^{2-}$ ). In case of *closo*-dodecaborate anion, we started with  $[B_{12}H_{12}]^{2-}$  and boron trifluoride etherate was used as the electrophilic inducer. For *closo*-decaborate anion, the starting reagent was  $[B_{10}H_{11}]^{-}$  (in fact, it is a complex of the cluster and the electrophilic inducer in a ratio of 1:1). In the studied processes carboxylic acids or its esters act as nucleophiles.

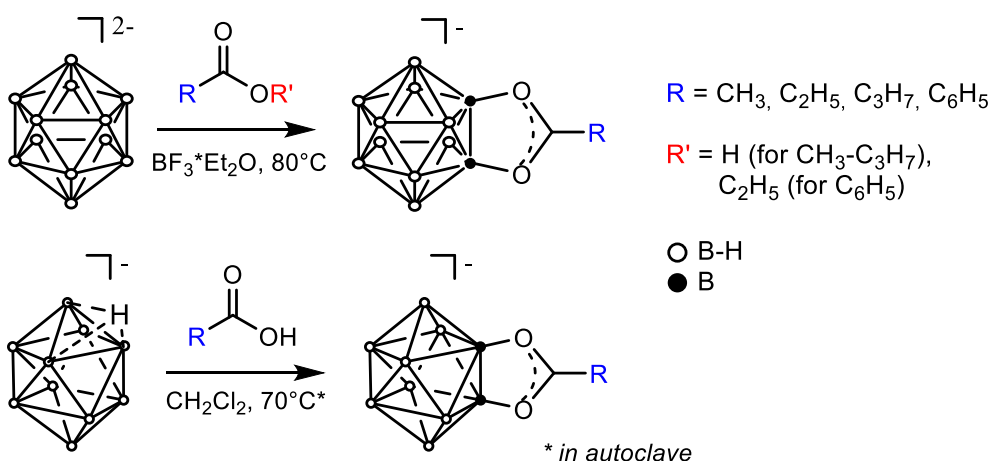

**Scheme 1.** Preparation of carboxonium derivatives based on *closo*-dodecaborate (top) and *closo*-decaborate (bottom)

The obtained compounds were characterized by NMR spectroscopy ( $^1H$ ,  $^{11}B$  and  $^{13}C$ ), IR spectroscopy, mass spectrometry and X-ray structural analysis.

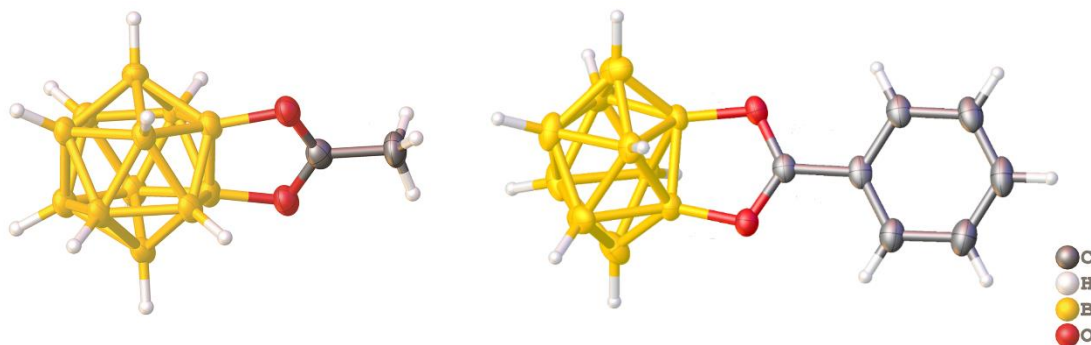

**Figure 1.** X-ray structures of  $[1,2-B_{12}H_{10}O_2CCH_3]^{-}$  (left) and  $[2,6-B_{10}H_8O_2CC_6H_5]^{-}$  (right)



# NON-COVALENT INTERACTIONS IN ADDUCTS OF PLATINUM(II) AND PALLADIUM(II) ISOCYANIDE COMPLEXES WITH MOLECULAR IODINE

*Komova P.V.<sup>1</sup>, Kinzhalov M.A.<sup>1</sup>*

<sup>1</sup>St. Petersburg State University, St. Petersburg, Russia

Student

st106277@student.spbu.ru

Supramolecular chemistry is a fast-growing discipline that studies chemical systems formed from molecules that are linked together by non-covalent interactions.

The palladium(II) and platinum(II) complexes with halogenated phenylisocyanides  $[MX^1_2(CNC_6H_4-4-X)_2L]$  ( $M = Pd, Pt$ ;  $X^{1,2} = Cl, Br, I$ ) have been proposed in our recent research as a new class of organometallic synthons for crystal-chemical design involving halogen bonds [1], [2]. In this work presented, the adducts of  $trans-[PtI_2(CNC_6H_4-Cl-4)_2] \cdot I_2$ ,  $trans-[PdI_2(CNC_6H_4-Cl-4)_2] \cdot I_2$  complexes of  $trans-[MI_2(CNC_6H_4-4-Cl)_2]$  ( $M = Pd, Pt$ ) and molecular iodine obtained by co-crystallization of the complex and  $I_2$  (molar ratio 1: 1, 20-25 °C) solution in  $CH_2Cl_2$ . The formation of brown crystals of the composition  $trans-[PdI_2(CNC_6H_4-Cl-4)_2] \cdot I_2$  and  $trans-[PtI_2(CNC_6H_4-Cl-4)_2] \cdot I_2$  was the result. The complexes were characterized by X-ray diffraction. There was found the adducts are isostructural and there are short contacts of the following types: halogen bond between the iodine molecules and the coordinated iodide ligand,  $NCN \cdots M$  contact between two neighboring complexes of the molecules and  $H \cdots I-I$  hydrogen bond. In the both cases, the  $I-I \cdots I-M$  contact is 87% of the doubled of van der Waals radius of iodine according to Bondi, so the corresponding angle  $\angle I-I \cdots I$  (about  $172^\circ$ ) is close to  $180^\circ$ . The bond lengths  $N_{CN} \cdots M$  for  $M = Pd, Pt$  are 3.454 and 3.491 Å. This value shorter than the sum of van der Waals radii and the values of angles  $\angle C \equiv N \cdots M$  are close to  $90^\circ$  (equal to  $88.4$  and  $89.7^\circ$  respectively). The described structure-oriented interactions forming parallel heterolayers of noncovalently bound by molecules of the complexes.

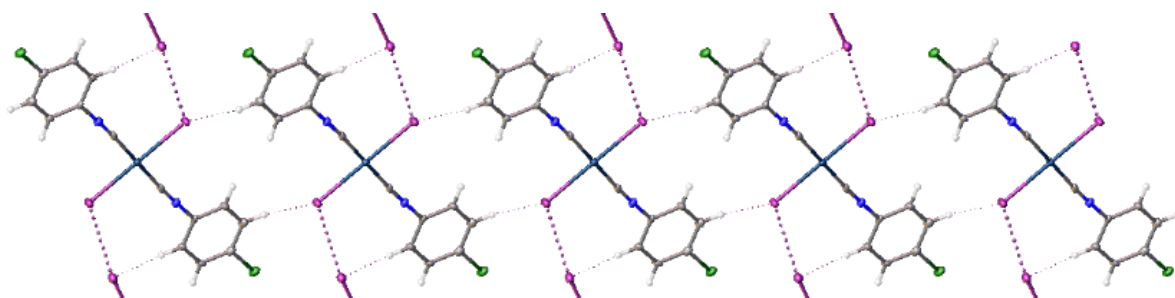

**Scheme 1.** The adduct of platinum(II) with molecular iodine  $trans-[PtI_2(CNC_6H_4-Cl-4)_2] \cdot I_2$ .  $trans-[PdI_2(CNC_6H_4-Cl-4)_2] \cdot I_2$  is arranged in a similar way.

## References

- [1] *Angew. Chem. Int. Ed.* **2018**, 57, 12785
- [2] *Chem. Asian J.* **2019**, 14, 3915

## Acknowledgements

This work was supported by a grant from the Ministry of Science and Higher Education of the Russian Federation for large-scale research projects in high priority areas of scientific and technological development (grant number [075-15-2024-553](#)). Measurements were performed at Center for Magnetic Resonance, Center for X-ray Diffraction Studies, Center for Chemical Analysis and Materials Research, and Computing Centre (all belong to St Petersburg University).

# ELECTROPHILIC-NUCLEOPHILIC DUALISM OF IODIDES IN Pt(IV) DIALKYL CYANAMIDE COMPLEXES

*Kostareva M.B.<sup>1</sup>, Ivanov D.M.<sup>1</sup>*

<sup>1</sup>St. Petersburg State University, St. Petersburg, Russia

Student

[st097945@student.spbu.ru](mailto:st097945@student.spbu.ru)

Organic iodine-based species [1], especially those with electron-withdrawing substituents, are well-known as  $\sigma$ -hole donors or halogen bond (XB) [2,3] donors. Conversely, moieties possessing lone pairs or electron-rich  $\pi$ -systems serve as XB acceptors. In our research, we investigate whether the coordination to a metal can make iodide electrophilic enough to participate in halogen bonding interactions.

Cocrystallizations of trans-[PtI<sub>2</sub>(NCNR<sub>2</sub>)<sub>2</sub>] (R<sub>2</sub> = (CH<sub>2</sub>)<sub>4</sub>, Et<sub>2</sub>) with diiodine lead to oxidative addition (Fig. 1, A, B). Alongside conventional I–I⋯I–Pt XBs, where iodide atoms bound to platinum are XB acceptors, reversed Pt–I⋯I–I interactions occur, where the electrophilic iodide in the coordination sphere of Pt(IV) forms halogen bonds with iodine molecules. The presence of non-covalent interactions and the philicity of participants are confirmed through DFT calculations.

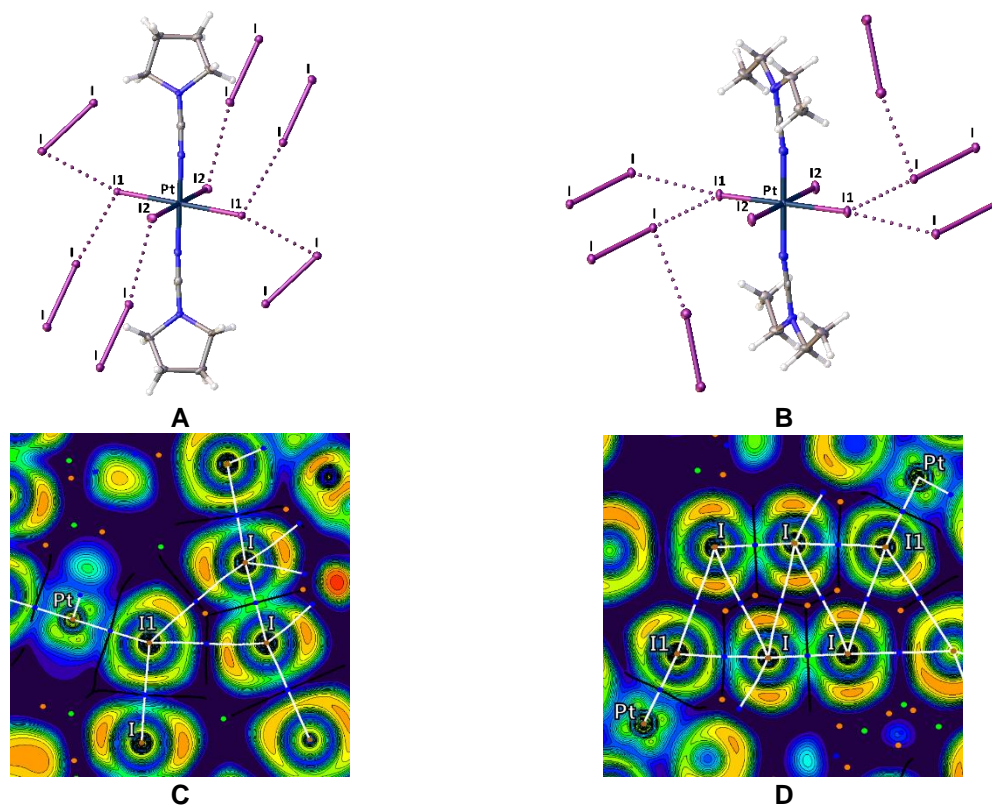

**Figure 1.** View of Pt–I⋯I–I halogen bonds in [PtI<sub>4</sub>(NCN(CH<sub>2</sub>)<sub>4</sub>)<sub>2</sub>]·2I<sub>2</sub> (A) and [PtI<sub>4</sub>(NCNEt<sub>2</sub>)<sub>2</sub>]·4I<sub>2</sub> (B) and corresponding electron localization function projection for the XB in crystal model with periodic boundary conditions (C and D).

## References

- [1] *Polyhedron* **2019**, 166, 137–140
- [2] *Pure Appl. Chem.* **2013**, 85, 1711–1713
- [3] *Chem. Rev.* **2016**, 116, 2478–2601

## Acknowledgements

The work was supported by the Russian Science Foundation (project 22-73-10021). Scientific research was performed using the equipment of the Research Park of St. Petersburg State University (Centre for X-ray Diffraction Studies, Chemical Analysis and Materials Research Centre).

# SPECTROSCOPIC INVESTIGATION OF Np(V) COMPLEXES WITH N,O-DONOR LIGAND IN ORGANIC PHASE

*Krot A.D.<sup>1</sup>, Matveev P.I.<sup>1</sup>*

<sup>1</sup> Moscow State University, Moscow, Russia Student  
[anna.d.krot@gmail.com](mailto:anna.d.krot@gmail.com)

Nuclear power industry, being one of the most robust “green” energy sources, is constantly developing to meet the most recent efficiency, non-proliferation and safety requirements. To satisfy these criteria, new types of fuel, reactors and related technological processes are continuously investigated. For spent nuclear fuel (SNF) reprocessing, only PUREX process is currently applied in industry, and numerous modifications (GANEX, Euro-GANEX etc) with advanced extraction systems are proposed to achieve better separation or avoid redox stages. An extensive research is focused on the development of more effective and selective systems for separation of minor actinides (Np, Am, Cm) and lanthanides. However, little is known about Neptunium chemistry even under the conditions of the most common and the only industrially used PUREX process. Initially, Np is present in SNF as neptunoyl-ion  $\text{NpO}_2^+$ , which is thought to be an unextractable form [1]. Due to high redox sensitivity of Np, it can easily be transformed to  $\text{Np}^{4+}$  and  $\text{NpO}^{2+}$ , which are considered extractable in limited systems investigated [2]. Np chemistry is further complicated by its affinity to form heterovalent structures with cation-cation interactions (CCI) involved, which are hardly identified in solution. Assumptions of Np oxidation state in organic phase are generally made based on the expected regularities of the extraction efficiency of different valence states in experiments made at tracer scale Np concentrations, lacking a direct spectroscopic evidence and structural information. Here we report an extensive investigation of Np oxidation state and complexation in solvent extraction systems of 3 M  $\text{HNO}_3$  and N,N-diethyl-N,N-di(4-ethyl-phenyl)-diamide in the organic phase, which have previously shown a good enough actinides/lanthanides separation factors [3]. Experiments were made at millimolar concentrations of Np at specified oxidation state (Np(IV), Np(V) and Np(VI)), and its redox behaviour and structural characteristics in organic solution were probed using a combination of advanced spectroscopic techniques (XANES, NMR, EPR) supplemented by theoretical calculations. Data on Np complexes in liquid phase were compared to the obtained solid-state crystal structures with analogous extractants. The results show that despite the high tendency of Np to undergo redox reactions and generally accepted unextractability of Np(V), it can be stabilized in the organic phase with an N,O-donor diamide of 2,2-bipyridine-6,6-dicarboxylic acid.

## References

- [1] *Radiochimica Acta* **2020**, 110, 527–548
- [2] *Radiochemistry* **2012**, 54, 315–323
- [3] *Inorganic Chemistry* **2024**, 63, 2109-2121

## Acknowledgements

This work was supported by the Russian Science Foundation (project No 23-73-30006).

WHITE IS THE NEW BLACK. COORDINATION COMPOUNDS DERIVED FROM WHITE PHOSPHORUS ACTIVATION AS ELECTROCATALYSTS FOR HYDROGEN PRODUCTION

*Kuchkaev Airat M.<sup>1</sup>, Kuchkaev Aidar M.<sup>1</sup>, Sukhov A.V.<sup>1</sup>, Zueva E.M.<sup>1</sup>, Yakhvarov D.G.<sup>1</sup>*

<sup>1</sup>Arbuzov Institute of Organic and Physical Chemistry, FRC Kazan Scientific Center of RAS, Kazan, Russia

Junior researcher, Ph.D.

[95ka@bk.ru](mailto:95ka@bk.ru)

Transition-metal mediated white phosphorus activation and transformation have attracted increasing attention as an ecological alternative to P<sub>4</sub> chlorination route to the important phosphorus products [1,2]. However, the properties of the complexes obtained this way are little studied.

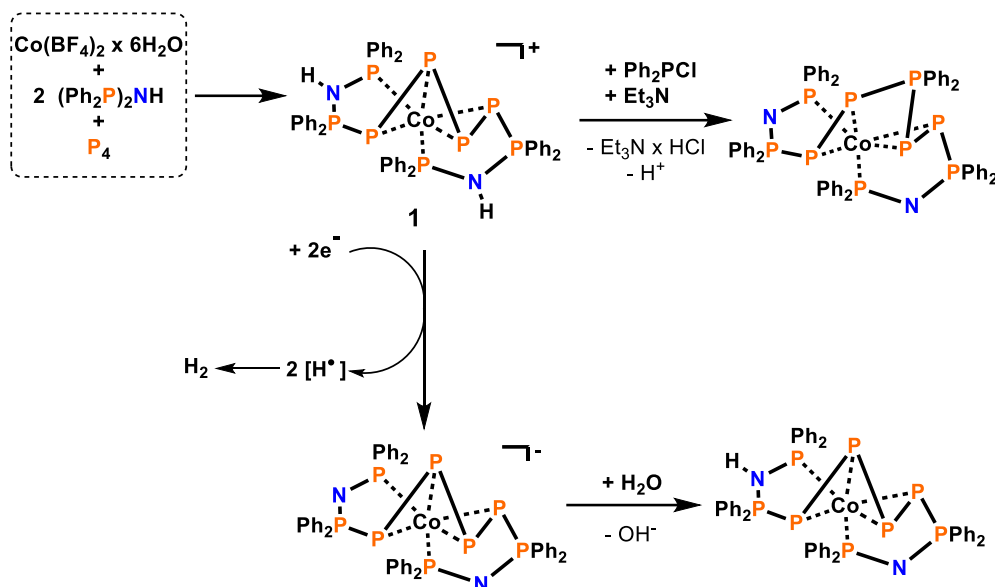

**Scheme 1.** Synthesis, reactivity, and electrochemical properties of cobalt complexes bearing polyphosphorus ligands

We report a facile approach for P<sub>4</sub> activation and transformation using cobalt complexes bearing PNP ligands.[3] The use of *N,N*-bis(diphenylphosphino)amine as a ligand allows one to transform P<sub>4</sub> tetrahedron into a zig-zag chain with the formation of complex  $[\text{Co}(\text{Ph}_2\text{PNHP}(\text{Ph}_2)\text{PPPPP}(\text{Ph}_2)\text{NHPPH}_2)]\text{BF}_4$  (**1**). This complex can readily be functionalized by means of the reaction with Ph<sub>2</sub>PCl leading to the formation of a new complex bearing unique P<sub>9</sub>-ligand. Moreover, complex **1** exhibits catalytic activity in hydrogen evolution reaction under the conditions of homogeneous electrocatalysis.

## References

- [1] *Coord. Chem. Rev.* **2021**, *441*, 213927  
 [2] *Chem. Eur. J.* **2021**, *27*, 1886-1902  
 [3] *Angew. Chem. Int. Ed.*, **2022**, *61*, e202210973

## Acknowledgements

This work was supported by the Russian Science Foundation (project No 23-13-00427).

## BIDENTATE LEWIS ACIDS FOR SMALL MOLECULE ACTIVATION.

*Kudina P.I., Kazakov I.V.*<sup>1</sup>

<sup>1</sup> St. Petersburg State University, St. Petersburg, Russia  
Student  
[st094704@student.spbu.ru](mailto:st094704@student.spbu.ru)

Approximately 15 years ago, the concept of Frustrated Lewis Pairs (FLPs) emerged in the field of chemistry [1]. The first example was an FLP formed by trispentafluorophenylborane  $B(C_6F_5)_3$  and tritertbutylphosphine  $tBu_3P$  [1]. FLPs are unique mixtures of a potent acid and a robust Lewis base that do not form traditional adducts due to steric hindrances. This distinctive property allows FLPs to exhibit exceptional abilities in activating small molecules and chemical bonds, such as  $H_2$ ,  $CO_2$ , p-block oxides, alkenes, and alkynes as metal-free catalysts.

The reversible absorption and release of hydrogen at varying temperatures using FLPs have proven valuable, particularly in processes like the hydrogenation of olefins [2]. While FLPs based on monodentate acids have been extensively researched, those based on bidentate acids remain relatively unexplored. Bidentate Lewis acids offer the advantage of being able to coordinate two Lewis bases simultaneously, enabling reactions that were previously unattainable with monodentate acids [3].

In this study, we present a straightforward synthetic method for producing potent bidentate Lewis acids featuring the  $-OB(C_6F_5)_2$  group. Diols undergo quantitative reaction with  $B(C_6F_5)_3$  to yield the desired products through the elimination of pentafluorobenzene (Scheme 1). The reaction products of  $B(C_6F_5)_3$  with benzene-1,4-diol, benzene-1,3-diol, and ethane-1,2-diol were thoroughly characterized using NMR, IR, and mass-spectroscopy techniques. Bidentate Lewis acids structures were confirmed by single crystal X-ray diffraction.

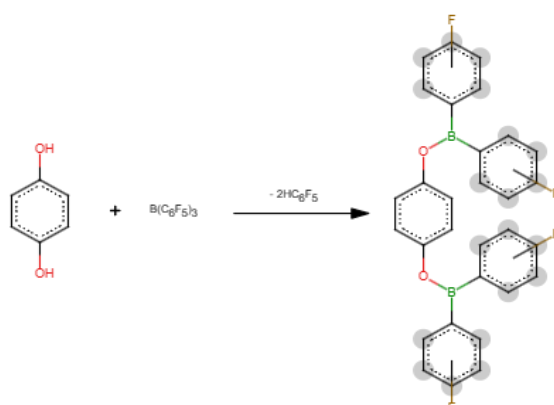

**Scheme 1.** Synthesis of bidentate Lewis acid by interaction of benzene-1,4-diol with trispentafluorophenylborane.

Testing was conducted to evaluate the activity of bidentate Lewis acids as a component of the frustrated Lewis pair (FLP). This was achieved through their reaction with tritertbutylphosphine  $tBu_3P$  in the presence of molecular hydrogen. Notable changes were observed in the  $^1H$  and  $^{19}F$  NMR spectra, indicating the activation of  $H_2$ . This study presents a unique example of an FLP incorporating a bidentate Lewis acid.

### References

- [1] *Science* **2006**, 314, 1124–1126.
- [2] *Angew. Chem. Int. Ed.* **2012**, 51(40), 10164–10168.
- [3] *Synlett.* **2012**, 23(5), 699–705.

### Acknowledgements

This work was financially supported by the Russian Science Foundation grant 23-23-00597. The work was carried out using equipment of the resource centers of St. Petersburg State University “Centre for Magnetic Resonance” and “Centre for X-ray Diffraction Studies”.

FORMATION OF METASTABLE SOLID SOLUTIONS  $\text{Rh}_x\text{Cu}_{1-x}$  AND  $\text{Ir}_x\text{Cu}_{1-x}$   
DURING THERMAL DECOMPOSITION OF COMPLEX PRECURSORS

*Lagunova V.I.<sup>1</sup>, Filatov E.Yu.<sup>1</sup>, Korenev S.V.<sup>1</sup>*

<sup>1</sup> Nikolaev Institute of Inorganic Chemistry SB RAS, Novosibirsk, Russia

PhD student

[varvara@niic.nsc.ru](mailto:varvara@niic.nsc.ru)

Metal solid solutions have found many applications in various fields and can be used as catalytic materials, to create electrodes, and to control and enhance the physicochemical properties of materials (e.g., increasing stability and strength). The creation of metastable solid solutions, i.e. such systems that should not exist in equilibrium conditions, leads to significant changes (improvements) in the physicochemical properties of the resulting bimetallic particles. Such systems can exhibit enhanced catalytic activity, which may be associated with excess surface energy in metastable solid solutions. Among the existing methods for the synthesis of solid solutions, the method of thermal decomposition of coordination precursors can be highlighted. This method allows to vary both the composition of the initial complex compounds and the conditions of their thermal decomposition (atmosphere, heating rate, final decomposition temperature), which opens a wide range of possibilities to obtain a variety of metallic nanoscale products.

A series of complex precursors  $[\text{M}(\text{NH}_3)_5\text{Cl}][\text{Cu}(\text{C}_2\text{O}_4)_2\text{H}_2\text{O}]$  and  $[\text{M}(\text{NH}_3)_6]_2[\text{Cu}(\text{C}_2\text{O}_4)_2]_3 \cdot 6\text{H}_2\text{O}$  ( $\text{M} = \text{Rh}, \text{Ir}$ ) were obtained and characterized (PXR, X-ray crystallography, IR spectroscopy, elemental analysis). The thermal decomposition process of the obtained compounds was studied in detail in reducing and inert atmospheres with the determination of the composition of intermediate and final products. Using *in situ* and *ex situ* PXR methods, it was shown that during thermal decomposition in a reducing atmosphere all complex compounds decompose with the formation of the metastable solid solutions (Scheme 1). The composition of metastable solid solutions was determined by X-ray diffraction using a calibration curve plotted as a function of atomic volume and solid solution composition. In the case of the Rh-Cu system, it was possible to obtain a solid solution with a maximum copper content of 28 at.%. And for the Ir-Cu system, a series of single-phase solid solutions were obtained with the ratio of metals given by the ratio of metals in the precursor compounds (2:3, 1:1).

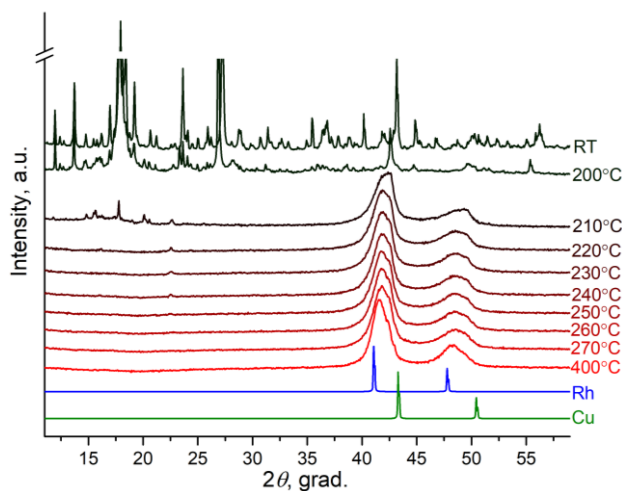

**Scheme 1.** *In situ* X-ray diffraction pattern of  $[\text{Rh}(\text{NH}_3)_5\text{Cl}][\text{Cu}(\text{C}_2\text{O}_4)_2\text{H}_2\text{O}]$  at different temperatures in a hydrogen atmosphere.

# CYCLOMETALATED RUTHENIUM(II) COMPLEXES WITH VARIOUS ARYLAZOLES: FINE TUNING OF ELECTRONIC STRUCTURE

*Lavrova M.A.*<sup>1</sup>, *Mishurinskii S.A.*<sup>1</sup>, *Verzun S.A.*<sup>1</sup>, *Sirotin M.A.*<sup>1,2</sup>, *Korshunov V.M.*<sup>3</sup>, *Dolzhenko V.D.*<sup>1</sup>

<sup>1</sup>Chemistry Department, M.V. Lomonosov Moscow State University, Moscow, Russia

<sup>2</sup>N.N. Semenov Federal Research Center for Chemical Physics, Moscow, Russia

<sup>3</sup>P.N. Lebedev Physical Institute of the Russian Academy of Sciences, Moscow, Russia

PhD student

[mariia.lavrova@chemistry.msu.ru](mailto:mariia.lavrova@chemistry.msu.ru)

Ruthenium(II) polypyridine complexes have a wide range of applications. A great research interest in these compounds was aroused by their record efficiency in dye sensitized solar cells (DSSCs). Standard dyes for these cells use isothiocyanates as antenna ligands, making the complexes unstable.

The introduction of a cyclometalated fragment at one time both increases the kinetic and thermodynamic stability of the complexes and introduces large changes in the electronic structure of the dye, which dramatically affects its properties.

Due to the intense absorption of sunlight in the entire visible range, such complexes can be used in many processes that require photosensitization of semiconductor nanoparticles - in photooxidation and photoreduction of water, in the photocatalysis of various organic reactions. Therefore, an important task remains the development of approaches to the design of complex compounds for the directed change of the electronic structure of the dye.

Ligands of the arylazole class are ideal from the point of view of studying electronic effects due to their synthetic availability, a large choice of introduced substituents in different fragments of the ligand, access to the extension of the conjugated system and introduction of various heteroatoms into it.

In our work, we focused specifically on the modification of the antenna ligand. Such complexes typically utilize 4,4'-dicarboxy-2,2'-bipyridine as the anchoring ligand. In our work the dimethyl ester of 4,4'-dicarboxy-2,2'-bipyridine was chosen rather than an acid, since this simplifies the study of the properties of the complexes in solution, and at the same time leaves the possibility of hydrolysis of ester groups (as a result of which the properties of the complexes do not change significantly) and application to the surface of the semiconductor.

In this work, compounds of various modified 2-arylbenzimidazoles, 2-arylphenanthroimidazoles, 2-aryloxazoles and 1-arylpyrazoles have been investigated [1,2].

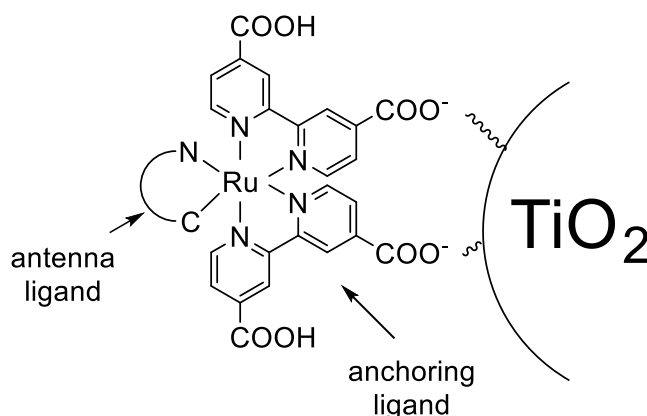

**Scheme 1.** Scheme of the dye.

## References

[1] *Dalton Transactions* **2020**, 49(46), 16935-16945.

[2] *Molecules* **2023**, 28(18), 6541.

# TRANSFORMATIONS OF CeO<sub>2</sub> NANOPARTICLES IN SODIUM-PHOSPHATE BUFFER SOLUTIONS: INVESTIGATING THE STRUCTURE AND PROPERTIES OF THE RESULTING PRODUCTS

*Listova A. L.*<sup>1</sup>, *Plakhova T. V.*<sup>1</sup>, *Kuzenkova A. S.*<sup>1</sup>, *Shaulskaya M. D.*<sup>1</sup>, *Tsybarenko D. M.*<sup>1</sup>,  
*Gerasimov M.A.*<sup>1</sup>, *Novichkov D. A.*<sup>1</sup>, *Romanchuk A. Yu.*<sup>1</sup> and *Kalmykov S. N.*<sup>1</sup>

<sup>1</sup> Lomonosov Moscow State University, Department of Chemistry, Moscow, Russia  
Student

[alvovna@yandex.ru](mailto:alvovna@yandex.ru)

The cerium dioxide (CeO<sub>2</sub>) is of great interest among the cerium compounds. CeO<sub>2</sub> nanoparticles (NPs) are greatly useful for a wide variety of applications, such as medicine, catalysis, abrasive materials, fuel cells, glasses, UV filters etc. It was estimated that the global release of CeO<sub>2</sub>-NPs in the environment will be 1000 t per year, which may have a negative impact on nature [1]. In the research devoted to the environmental fate of CeO<sub>2</sub> NPs, the transformations of CeO<sub>2</sub> under the influence of phosphates are noted [2]. However, there is still a lack of information about the structures, morphology, and properties of the resulting substances. On the other hand, Ce(IV) is a non-radioactive analogue of the dangerous Pu(IV) because of the similarity of their ionic radii and hydrolysis constants. Also, cerium and plutonium dioxides crystallize into the structural type of fluorite and have close lattice parameters. Therefore, the data on cerium transformations in phosphate-containing solutions may be helpful for reliable modelling Pu(IV) speciation in the environment and predicting radionuclides migration pathways.

Thus, the present work aims to investigate the structure and properties of phases obtained after CeO<sub>2</sub> NPs interaction with sodium phosphate buffer solutions under different conditions. The analysis of the phase transformation mechanism is also conducted in the present study.

First, the synthesis of CeO<sub>2</sub> NPs was carried out using a chemical precipitation method from Ce(IV) ammonium nitrate as a cerium source. The obtained CeO<sub>2</sub> NPs were subjected to hydrothermal (HT) treatment at 150°, 170° and 200°C in 1M sodium phosphate buffer solutions at pH=4,4 and 7,7. The resulting products were characterized by X-ray powder diffraction (XRD) with pair distribution function analysis (PDF), scanning electron microscopy (SEM), transmission electron microscopy (TEM), energy dispersive X-ray spectroscopy (EDX) and X-ray absorption near L<sub>3</sub> edge Ce spectroscopy (XANES). The solubility of resulting Ce phosphate phases in 0.01M NaClO<sub>4</sub> at different pH values was investigated by inductively coupled plasma mass spectrometry (ICP-MS).

According to XRD data of samples obtained after hydrothermal treatment in sodium phosphate buffers, new phases have formed. Two completely different phases were obtained after treatment at various pH values, while the synthesis temperature's influence on the samples' structure and morphology was not detected. The structure of the sample obtained at pH=7.7 is close to the Na<sub>2</sub>Ce(PO<sub>4</sub>)<sub>2</sub>·xH<sub>2</sub>O phase known from literature data [3].

In the case of HT synthesis at pH 4.4, a double cerium-sodium phosphate with a structure previously unknown in the literature was formed. According to XANES data, cerium in the structure of a new phase is predominantly in tetravalent form. EDX data confirmed the presence of sodium and cerium in the phosphate structure. SEM and TEM data showed that the morphology of the samples obtained at pH=4.4 are aggregated crystalline nanorods around 15 nm in width. PDF analysis revealed that the structures of the new Na-Ce(IV) phosphates have a framework motif similar to NaTh<sub>2</sub>(PO<sub>4</sub>)<sub>3</sub> [4], formed by cerium atoms and phosphate groups with channels occupied by sodium ions in the ab plane.

The solubility of double Na-Ce(IV) phosphates of different structures in 0.01M NaClO<sub>4</sub> at pH 2-10 was determined. As can be seen from the ICP-MS data, increasing the pH value from 2 to 4 leads to a decrease in cerium concentration in solution from 3\*10<sup>-6</sup> to 8\*10<sup>-8</sup> M. The solubility of Na-Ce(IV) phosphate is lower than the solubility of original CeO<sub>2</sub> NPs in solutions of similar composition [5]. Based on this, we can assume that the CeO<sub>2</sub> transportation to double Na-Ce(IV) phosphates occurs because of the phosphate's greater thermodynamic stability.

## References

- [1] *Sci. Rep.* **2018**, 8(1), 1565.
- [2] *Chemosphere*, 119, 1365
- [3] *ChemistrySelect.* **2024**, 9, 17
- [4] *Inorganica Chim Acta.* **1970**, 4, 571
- [5] *The Journal of Physical Chemistry.* **2016**, 120(39), 22615

## Acknowledgements

This work was supported by the Russian Science Foundation (grant no. 22-73-10056)



# SYNTHESIS AND PHOTOPHYSICAL PROPERTIES OF ANTHRACYL AND ETHYNYLANTHRACENE BIS-CYCLOMETALLATED GOLD(III) COMPLEXES BEARING A ETHYNYLDIPHENYLPHOSPHORYL GROUP

*Luginin M.E.<sup>1</sup>, Grachova E.V.<sup>1</sup>*

<sup>1</sup>St Petersburg University, St. Petersburg, Russia  
Postgraduate student  
[st085893@student.spbu.ru](mailto:st085893@student.spbu.ru)

Anthracene-based conjugated systems are widely studied due to their high luminescence quantum yields.[1] There are numerous examples of the use of anthracene derivatives to obtain luminescent platinum(II) [2] and gold(I) [3] complexes, while comparatively little attention has been paid to gold(III) complexes.

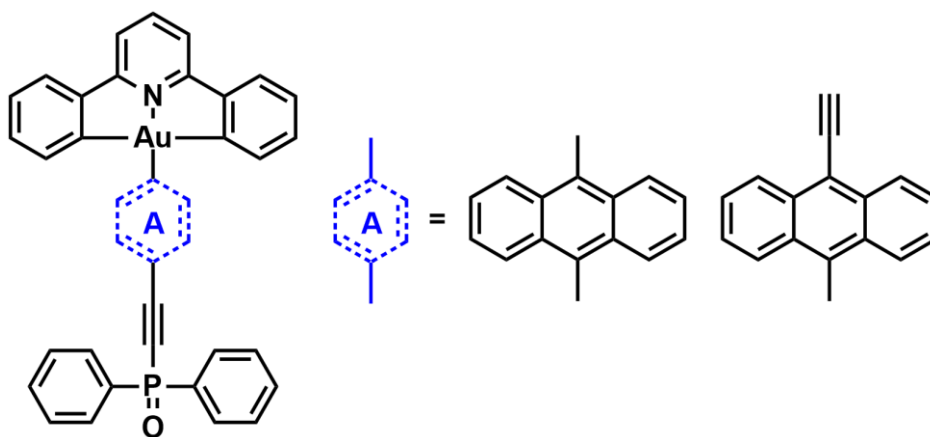

**Figure 1.** Structures of the obtained gold(III) complexes bearing anthracene moieties

The use of phosphine oxide groups is a promising area of research due to their function as electron acceptor groups, which can trigger a charge transfer mechanism affecting the luminescence of the system. Additionally, they can act as Lewis bases that can lead to the formation of intermolecular contacts and influence the photoluminescence of complexes in the solid state.

In this work, we present the synthesis of gold(III) complexes bearing a bis-cyclometallated C<sup>N</sup>C ligand as well as a ethynyldiphenylphosphoryl group on the periphery of the ligand environment connected with the metal centre using an anthracyl or ethynylantracene linker. We also discuss the photophysical properties of these systems.

## References

- [1] *J. Chem. Soc. Perkin Trans.* **1992**, 7, 755
- [2] *Polym. Chem.* **2016**, 7, 1070
- [3] *New J. Chem.* **2019**, 43, 13741

## Acknowledgements

This work is supported by the Russian Science Foundation (project No 24-13-00024). The studies were performed using the equipment of Centres for Magnetic Resonance, for Chemical Analysis and Materials Research (Research Park of St. Petersburg State University).

# SYNTHESIS OF NEW ORGANOMETALLIC COMPLEXES Re(I) WITH DIIMINE LIGANDS APPLICATION IN PHOTOACOUSTIC IMAGING

*Madieva S.G.<sup>1</sup>, Shakirova J.R.<sup>1</sup>, Tunik S.P<sup>1</sup>*

<sup>1</sup> St. Petersburg State University, St. Petersburg, Russia  
Student

[svetamadieva@gmail.com](mailto:svetamadieva@gmail.com)

Photoacoustic imaging (PAI) is a modern imaging method that can provide a high-resolution picture of absorption zones inside an object. The method also has a greater penetration depth compared to optical imaging [1].

The optical properties of bis(diimine) Re(I) complexes and the intensity of the photoacoustic signal depend on the pH of the medium, which allows them to be used for contrasting acidified areas and tissues using the PAI method. [2] In addition, the introduction of oligoethylene glycol fragments makes the complexes water-soluble. Thus, in this work, a series of complexes of the [(NN)Re(CO)<sub>2</sub>(NN\*)]<sup>+</sup> type was obtained, where NN is neocuproine and NN\* is a variable ligand.

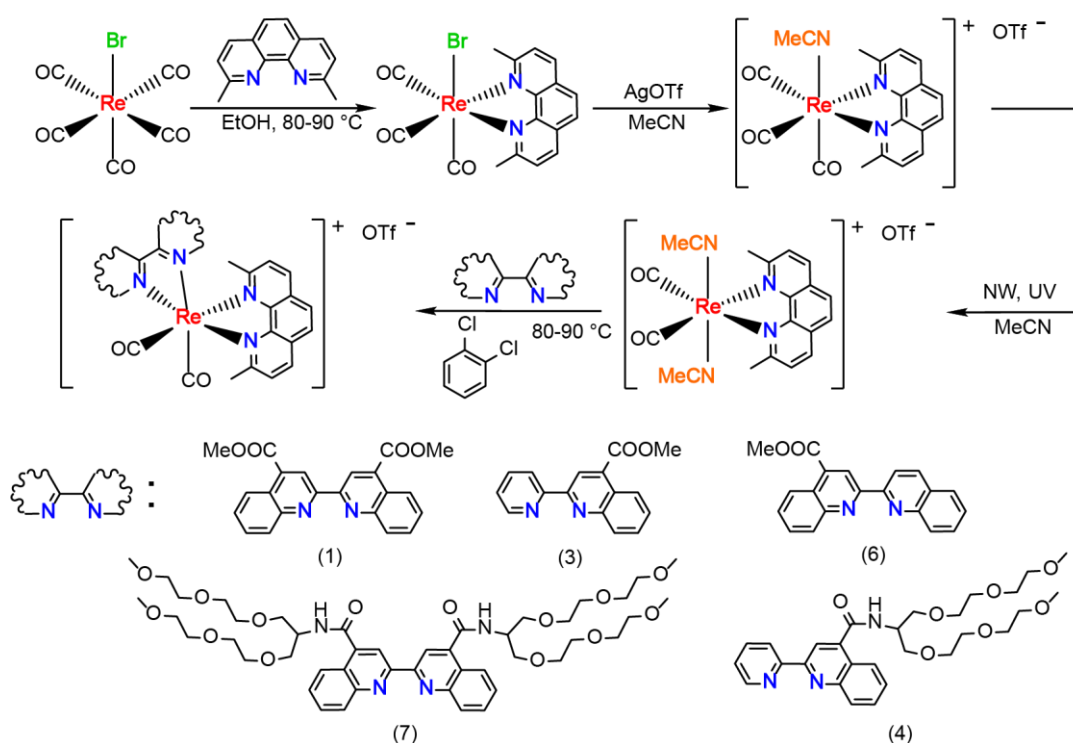

**Scheme 1.** Scheme of synthesis.

The synthesized Re(I) complexes were characterized by 1D (<sup>1</sup>H) and 2D (<sup>1</sup>H-<sup>1</sup>H COSY, NOESY) NMR spectroscopy and ESI<sup>+</sup> mass spectrometry. In addition, absorption spectra of solutions of the complexes were recorded and data from photoacoustic imaging experiments were obtained.

## References

- [1] *Nanomaterials*. **2022**, 12(3)
- [2] *Chempluschem*. **2020**, 85(11)

## Acknowledgements

This work was supported by the Russian Science Foundation (project No 19-73-20055-П) and was carried out using the equipment of the St. Petersburg State University Science Park (centers for magnetic resonance, optical and laser research, chemical analysis and materials research, research centre for X-ray diffraction studies).

## IMPLEMENTATION OF BALL-MILL AND SINTERING ADDITIVES FOR GRAIN BOUNDARIES ENGINEERING IN GARNET-TYPE LLZO SOLID ELECTROLYTE

*Markopolskii R.G.<sup>1</sup>, Timusheva N.B.<sup>1</sup>, Golubnichiy A.A.<sup>1</sup>, Morozov A.V.<sup>1</sup>, Savina A.A.<sup>1</sup>, Abakumov A.M.<sup>1</sup>*

<sup>1</sup> Skolkovo Institute of Science and Technology, Moscow, Russia  
Student, 1st year of Master's degree program  
[Roman.Markopolskii@skoltech.ru](mailto:Roman.Markopolskii@skoltech.ru)

All solid-state batteries (ASSBs) based on ceramic solid electrolytes are considered as the promising alternatives to conventional liquid organic electrolytes because of their potentially high specific gravimetric and volumetric energy density and increased safety [1]. One of the main features of ASSBs is the absence of flammable components, which increases the safety and the ability to accommodate high power density electrodes, such as Li-metal as an anode and Li-rich NMC cathodes, which results in a boost of specific energy density. However, the formation of Li dendrites remains a significant obstacle to the advancement of ASSB, as it invariably leads to short circuit and battery failure. Solid electrolytes are usually polycrystalline ceramic materials containing a substantial amount of grains and grain boundaries. The promising approach for suppressing lithium dendrite growth and propagation along the grain boundaries is their modification via mechanoactivation techniques and/or sintering additives. In turn,  $\text{Li}_{6.4}\text{Ga}_{0.2}\text{La}_3\text{Zr}_2\text{O}_{12}$  (Ga-LLZO) is considered as promising solid electrolyte for ASSBs due to its high Li-ion conductivity ( $\sim 10^{-3}$  -  $10^{-4}$  S/cm at 25 °C), wide electrochemical stability window (0.05 – 5 V vs. Li/Li<sup>+</sup>), and chemical stability against metallic lithium [2].

This work aims to study the influence of synthesis parameters and sintering additives on the microstructure and electrochemical properties of Ga-LLZO solid electrolyte with cubic garnet-type structure.  $\text{Li}_3\text{BO}_3$  (LBO) and PVDF were used as sintering additives because they promote liquid-phase sintering and increase the ohmic resistance of the Ga-LLZO grain boundaries [3]. In this work, single-phase Ga-LLZO solid electrolyte pellets at different LBO (0.25% wt. – 8% wt.) and PVDF (1% wt., 2% wt.) concentrations were synthesized by conventional solid-state synthesis using ball-milling and isostatic pressing. All samples exhibit high ionic conductivity and relative density > 90% relative to the crystallographic one. The influence of LBO and PVDF concentration on the microstructure organization of Ga-LLZO solid electrolyte membranes and their electrochemical properties were investigated.

### References

- [1] *Materials Futures* **2022**, 2, 013501
- [2] *Advanced Materials* **2021**, 33, 2002325
- [3] *Advanced Materials* **2023**, 35, 2208951

### Acknowledgements

This work was supported by the Russian Science Foundation (project No 23-73-30003).

# THERMAL EFFECTS OF DOUBLE SALTS DISSOLUTION IN THE SYSTEM LiCl-RbCl-H<sub>2</sub>O

*Medvedeva M.D.<sup>1</sup>, Pestova O.N.<sup>1</sup>,*

<sup>1</sup>St. Petersburg State University, St. Petersburg, Russia

Student

[st117539@student.sbpu.ru](mailto:st117539@student.sbpu.ru)

Alkali metals chlorides are necessary components of natural water, which are complex multicomponent equilibrium water-salt systems. Currently, there is a question of extraction of alkali metals from natural brines, seawater and subsequent separation of components. The most relevant question is the extraction of lithium salts, which are widely used in lithium-ion batteries [1]. Equally important is the isolation of rubidium and caesium salts contained in low concentrations in natural water. For the above reasons, it is important to study solution-solid phase transition, namely thermodynamic characteristics of salt dissolution processes.

The purpose of this research was to study the thermal effects of double salts dissolution in the LiCl-RbCl-H<sub>2</sub>O system using the calorimetric method. According to the literature [2], the solubility isotherm of the LiCl-RbCl-H<sub>2</sub>O system at 25°C was plotted (figure 1). In the system two joint compounds with different molar ratios of components are formed: Rb:2Li and 3Rb:Li. Both salts contain crystalline water, which is typical for compounds containing structure-making cations (such as Li<sup>+</sup>, Mg<sup>2+</sup>, Ca<sup>2+</sup>, etc.) and are formed by cations of different nature - structure-making Li<sup>+</sup> and structure-breaking Rb<sup>+</sup>.

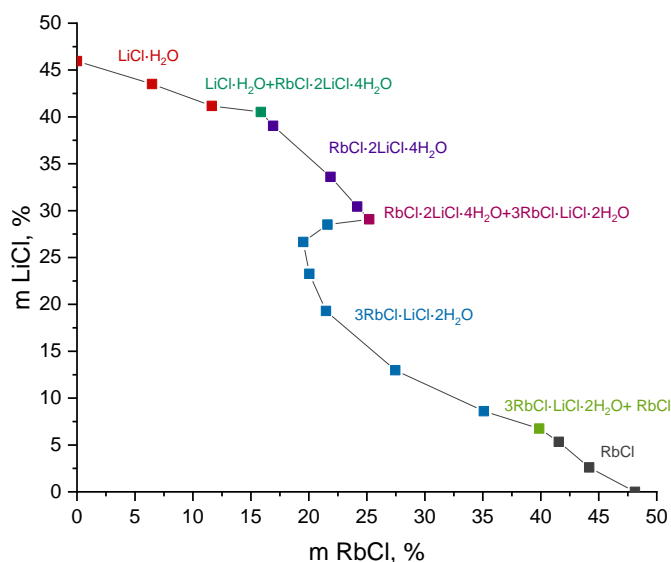

**Figure 1.** The solubility isotherm of the LiCl-RbCl-H<sub>2</sub>O system at 25°C

In this work, double salts RbCl·2LiCl·4H<sub>2</sub>O and 3RbCl·LiCl·2H<sub>2</sub>O were obtained from the ternary system LiCl-RbCl-H<sub>2</sub>O. The composition of the obtained salts was characterized by FTIR spectroscopy, argentometry, atomic emission spectrometry (ICP-AES). The enthalpy of dissolution of double salts was measured. Using the reference data and the experimental values obtained, the standard enthalpy of double salts formation and thermal effects of compounds formation from individual components were calculated. The results were compared with the previously obtained effects of double salts dissolution in the LiCl-CsCl-H<sub>2</sub>O system.

## References

- [1]. *Nat. Commun.*, **2020**, 11, 6279-6282
- [2]. *Pelsh A.D. Spravochnik po rastvorimosti solevykh sistem*, **1973**, 1, 50

## Acknowledgements

FTIR and ICP-AES measurements have been carried out in the Chemical Analysis and Materials Research Centre of Research Park of St. Petersburg State University.

DESIGN OF CYCLOMETALATED Ir (III) COMPLEXES WITH BENZOPHENAZINE AND BENZOQUINOXALINE MOIETIES FOR NIR EMISSION – EXPERIMENTAL AND THEORETICAL STUDY

*Meshcheriakova E.A.*<sup>1,2</sup>, *Tatarin S.V.*<sup>1</sup>, *Bezzubov S.I.*<sup>1</sup>

<sup>1</sup>Kurnakov Institute of General and Inorganic Chemistry RAS, Moscow, Russia

<sup>2</sup>Moscow State University, Moscow, Russia

Student

[elizaveta.meshcheriakova@chemistry.msu.ru](mailto:elizaveta.meshcheriakova@chemistry.msu.ru)

Cyclometalated Ir (III) complexes have attracted a widespread attention as effective luminophores, being thoroughly exploited as electrophosphorescent materials in organic light-emitting diodes, possessing ultimately high quantum yields along with excessive stability [1]. Still, complexes emitting in the NIR spectral region often suffer from low quantum yields due to ease of vibrational relaxation. In this work we aim to explore donor-acceptor aryl-quinoxaline moieties as cyclometalated ligands to yield low-energy emitting *bis*-cyclometalated iridium(III) complexes. Additional rigidity can be added to this ligand scaffold by construction of phenazine moieties.

Herein, we present a joint experimental and theoretical research (X-ray, NMR, MS, UV-Vis and luminescent spectroscopy, cyclic voltammetry, DFT/TDDFT) of several series of iridium (III) complexes with (di)benzophenazine and aryl-quinoxaline ligands (Scheme 1).

A methodological survey for quick and proper (MAD ~ 10 nm) prediction of phosphorescence maxima position is reported. The methodology is based on experiential data derived from luminescence spectroscopy for complexes of 4 types with different electronic structure. The influence of solvation effects, functionals and basis sets on the results of calculation is announced.

It is shown that dibenzophenazine *bis*-cyclometalated chloride dimer exhibits unexpected narrow (FWHM – 40 nm) and relatively intensive phosphorescence (30% quantum yield in toluene) at room temperature. Quantum chemical calculations (energy of frontier orbitals, distribution of electron and spin density) were done to explain the phenomenon. Spin density localization at organic part of metallacycle prevent phosphorescence for the most of Ir(III) dimeric compounds. The corresponding mononuclear *bis*-cyclometalated iridium(III) complex with an ancillary acetylacetonate ligand also demonstrate long-wavelength absorption and red-to-NIR emission.

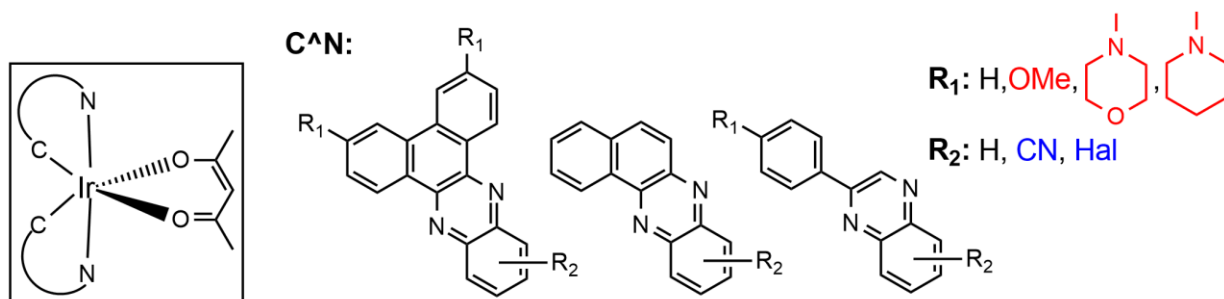

**Scheme 1.** The complexes presented in this work

## References

[1] *Chem. Eng.J.* **2023.** 452, 138956

PHOTOPHYSICAL AND PHOTOCHEMICAL PROPERTIES OF THE DIRHODIUM COMPLEX IN  
CONTEXT OF ITS POTENTIAL APPLICATION IN PHOTODYNAMIC THERAPY.

*Meshcheryakova V.A.*<sup>1,2</sup>, *Glebov E.M.*<sup>2</sup>

<sup>1</sup> Novosibirsk State University, Physics Faculty, Novosibirsk, Russia

<sup>2</sup> Voevodsky Institute of Chemical Kinetics and Combustion, Novosibirsk, Russia  
Student

[v.meshcheryakova@g.nsu.ru](mailto:v.meshcheryakova@g.nsu.ru)

Chemotherapy is currently one of the most common cancer treatment methods. However, drugs used in chemotherapy have their drawbacks, such as low specificity to tumor cells and a limited therapeutic index, which can lead to side effects. That is why alternative cancer treatment methods, such as photodynamic therapy (PDT), are actively being developed. This method is based on the use of photosensitizers that are activated by light and destroy cancer cells through photochemical processes. The mechanism of PDT involves reactions with reactive oxygen species. Given that many tumor tissues are hypoxic, there is interest in oxygen-independent methods, such as photochemotherapy (PCT).

Studies of platinum metal complexes have shown that during the photochemical reaction compounds are formed that have a mechanism of action similar to cisplatin [1]. Dirhodium complexes Rh(II,II)-polypyridyl, which have a double light-induced cytotoxic effect, both oxygen-dependent and independent. These complexes have shown the ability to exhibit anticancer properties and are potentially inhibitors of DNA transcription [2].

In this work the photophysics and photochemistry of the dppn ligand (benzo[*i*]dipyrido[3,2-*a*:2',3'-*h*]phenazine) and the dirhodium complex  $[\text{Rh}_2(\mu\text{-O}_2\text{CCH}_3)_2(\text{dppn})_2](\text{O}_2\text{CCH}_3)$  were studied, using stationary photolysis, laser flash photolysis, ultrafast laser spectroscopy. The photophysical characteristics of dppn solutions in acetonitrile were measured. For aqueous solutions of the complex it was shown that the primary photoreaction is the exchange of an acetate ligand for a water molecule.

#### References

- [1] *Bednarski P.J., et al. Anti-Cancer Agents in Medicinal Chemistry. 2007, 7, 75–93.*  
[2] *Coordination Chemistry Reviews. Elsevier, 2015, 282–283, 110–126.*

## SOLUTION-SOLID EQUILIBRIUM IN $\text{Co}(\text{NO}_3)_2 - 4,4'$ -BIPYRIDINE – EtOH – $\text{H}_2\text{O}$ SYSTEM

*Mikhaltsov A.E.<sup>1</sup>, Vesnovskii D.V.<sup>1</sup>, Mereshchenko A.S.<sup>1</sup>, Skripkin M. Yu.<sup>1</sup>*

<sup>1</sup> St. Petersburg State University, St. Petersburg, Russia

Student, bachelor

[st112377@student.spbu.ru](mailto:st112377@student.spbu.ru)

The study of phase equilibria is among the key topics on the agenda of chemical science, and is of interest not only for subtle theoretical studies of heterogeneous equilibrium solution – solid phase, but they are also a key aspect of studying both the effect of additives on the properties of solutions, traditional examples of which are cryoscopy and ebullioscopy methods, and the effect of the ratio of solution components on the composition of the crystallizing phase, starting from the already classical methods of studying phase equilibria in water-salt systems, including the young directions, such as, for instance, synthesis of organometallic skeleton structures, some of which are promising materials for electrodes in the case of the possibility of MOF formation both with oxidized and reducer forms of the metal cation, provided the stable half-reaction potential.

The purpose of this work is to attempt to reveal the effect of the ethanol-water ratio of the water-ethanol solvent used on the composition of the phase crystallizing from a 4-component solution (metal nitrate – 4,4'-bipyridine – ethanol – water) and to construct a phase diagram for these ratios in the form of a Gibbs triangle using the Roseboom method.

The study of the system was undertaken along several cross-sections of the composition prism in quasi-ternary systems containing 95 and 90 mol. % of alcohol. The result for 95 mol% is presented on the figure below.

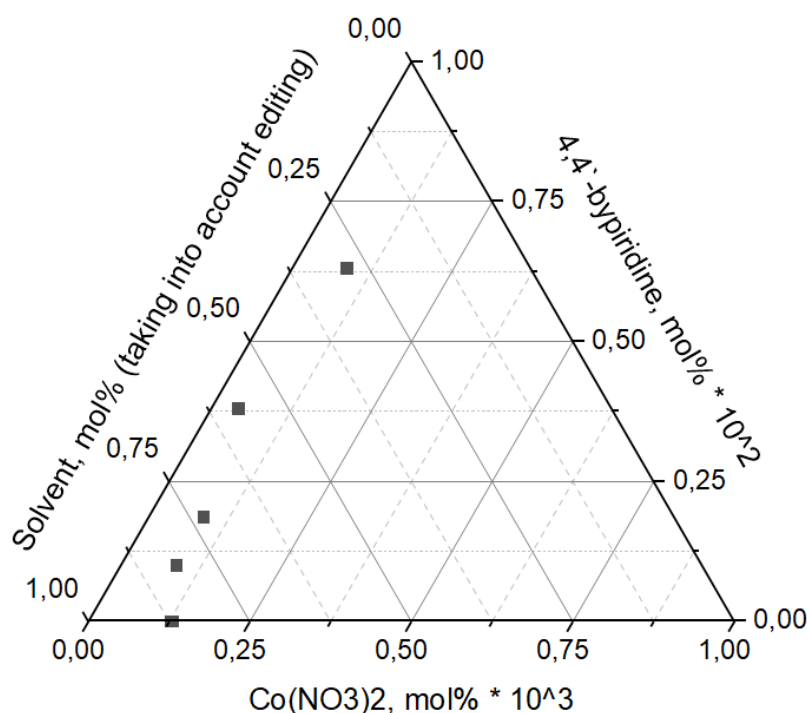

**Scheme 1.** Phase diagram for the system containing 95 mol. percent of alcohol.

For clarity, the mole fraction of cobalt nitrate is increased by 1000 times, the mole fraction of bipyridine is increased by 100 times.

### Acknowledgements

We express our sincere gratitude to the staff of the resource center "X-ray diffraction research methods" of St. Petersburg State University

# INFLUENCE OF P-ELEMENTS (P, S) ON THE PROPERTIES OF PALLADIUM CATALYSTS IN THE DIRECT SYNTHESIS OF HYDROGEN PEROXIDE

*Milenkaya E.A.<sup>1</sup>, Skripov N.I.<sup>1</sup>, Kornaukhova T.A.<sup>1</sup>, Belykh L.B.<sup>1</sup>, Schmidt F.K.<sup>1</sup>*

<sup>1</sup> Irkutsk State University, Irkutsk, Russia

Junior Researcher

[elencka.mil@gmail.com](mailto:elencka.mil@gmail.com)

The nature and properties of supported palladium catalysts modified with elemental phosphorus and elemental sulfur were studied in the direct synthesis of H<sub>2</sub>O<sub>2</sub> and side processes of direct synthesis: decomposition and "hydrogenation" of H<sub>2</sub>O<sub>2</sub> under mild conditions in ethanol and aqueous-ethanol media in the presence of various medium modifiers [1-2].

As a result of studying the influence of acid and halide modifiers on the properties of nanosized Pd-P catalysts supported on the Na- and H-form of ZSM-5 zeolite, in the direct synthesis of H<sub>2</sub>O<sub>2</sub>, the opposite effect of acid modifiers and salts on the yield of H<sub>2</sub>O<sub>2</sub> was discovered. It has been shown that, unlike HCl, potassium chloride, potassium sulfate, and sodium citrate have an inhibitory effect on the activity of the catalyst, partially suppressing the formation of H<sub>2</sub>O<sub>2</sub>. However, they have virtually no effect on the rate of H<sub>2</sub>O<sub>2</sub> hydrogenation. Moreover, in the presence of the Pd-P catalysts, an acid modifier (for example, H<sub>2</sub>SO<sub>4</sub>), even in the absence of halides, increases the yield of H<sub>2</sub>O<sub>2</sub> by 2 times. A hypothesis has been put forward about the different nature of the active centers responsible for the formation of H<sub>2</sub>O<sub>2</sub> in direct synthesis and in the hydrogenation of H<sub>2</sub>O<sub>2</sub>.

The main functions of the acid modifier are considered. It is assumed that Brønsted acid not only suppresses the deprotonation of H<sub>2</sub>O<sub>2</sub> to more reactive HO<sub>2</sub><sup>-</sup> ions, thereby increasing the selectivity of the process. It is probably also involved in the catalytic process itself, facilitating proton-electron transfer. In addition, HCl, promoting the corrosive dissolution of Pd<sup>0</sup>, causes partial deactivation of the catalyst during a long process at high acid concentration. Unlike hydrochloric acid, H<sub>2</sub>SO<sub>4</sub> does not have such an effect on the Pd-P/HZSM-5 catalyst.

Based on a combination of XPS, XRD, HRTEM and ICP-MS data, the main reasons for the promoting effect of phosphorus on the properties of the Pd-P/ZSM-5 palladium catalysts in the direct synthesis of H<sub>2</sub>O<sub>2</sub> from H<sub>2</sub> and O<sub>2</sub> under mild conditions are considered. It has been shown that the addition of phosphorus to the catalyst affects the dispersion, the electronic state of palladium in the surface layer and the surface concentration of phosphate and phosphite ions. An increase in the yield of H<sub>2</sub>O<sub>2</sub> is favored by an increase in the dispersion of the Pd-P catalysts, inhibition of the side process of H<sub>2</sub>O<sub>2</sub> decomposition by surface phosphate and phosphite ions, and a decrease in the solubility of hydrogen in solid solutions of phosphorus in palladium. It has been established that, along with phosphorus and acid modifiers, the use of a zeolite support in the H-form favors the inhibition of the side process of H<sub>2</sub>O<sub>2</sub> decomposition.

The interaction of Pd(acac)<sub>2</sub> with elemental sulfur in an inert atmosphere and in hydrogen under mild conditions was studied using UV spectrophotometry, HRTEM, EDS, and XRD. It has been shown that the composition of Pd-S containing nanoparticles formed in hydrogen, their size and degree of crystallinity depend on the ratio of the initial components. As the S:Pd ratio increases, the dispersion of the catalysts increases and a transition of Pd-S particles to an X-ray amorphous state is observed. The properties of Pd-nS/NaZSM-5 catalysts in the direct synthesis of H<sub>2</sub>O<sub>2</sub> were studied, and the influence of the S:Pd ratio on the activity, selectivity and yield of H<sub>2</sub>O<sub>2</sub> was examined. A comparative analysis of the influence of the nature of the p-element on the properties of palladium catalysts in direct synthesis was carried out.

## References

- [1] *Kinet. Catal.* **2023**, 64(6), 804
- [2] *Appl. Catal. A: Gen.* **2023**, 664, 119330

## Acknowledgements

This work was supported by the Government Assignment for Scientific Research from the Ministry of Science and Higher Education of the Russian Federation (FZZE-2024-0004).



# ANTENNA LIGAND NATURE EFFECTS ON ELECTRONIC STRUCTURE AND OPTICAL PROPERTIES OF DYES BASED ON CYCLOMETALLATED Ru(II) COMPLEXES WITH CONJUGATED 2-ARYLIMIDAZOLES

*Mishurinskii S.A.<sup>1</sup>, Elin A.D.<sup>1</sup>, Sirotin M.A.<sup>1,2</sup>, Korshunov V.M.<sup>3</sup>, Dolzhenko V.D.<sup>1</sup>, Lavrova M.A.<sup>1</sup>*

<sup>1</sup> Chemistry Department, M.V. Lomonosov Moscow State University, Moscow, Russia

<sup>2</sup> N.N. Semenov Federal Research Center for Chemical Physics, Moscow, Russia

<sup>3</sup> P.N. Lebedev Physical Institute of the Russian Academy of Sciences, Moscow, Russia  
Student

[sergei.mishurinskii@chemistry.msu.ru](mailto:sergei.mishurinskii@chemistry.msu.ru)

Ruthenium(II) complexes are used as sensitizers in the Grätzel solar cell and currently show record values of cell efficiency. The "champion" dyes use 4,4'-dicarboxy-2,2'-bipyridine as anchoring ligands and monodentate -NCS groups as donors, complexes with which are labile, leading to a rapid drop in cell efficiency. Replacement of isothiocyanate by bidentate cyclometalated ligand allows to increase the inertness of complexes, but at the same time leads to deterioration of optical and electrochemical properties of the dye, so the design of ligands remains an urgent task.

2-arylimidazoles are chosen as donor ligands in this work due to their synthetic availability and the ability to introduce various types of substituents. In order to increase light absorption of complexes we decided to enlarge conjugated system of antenna ligand and use 2-arylphenanthroimidazoles.

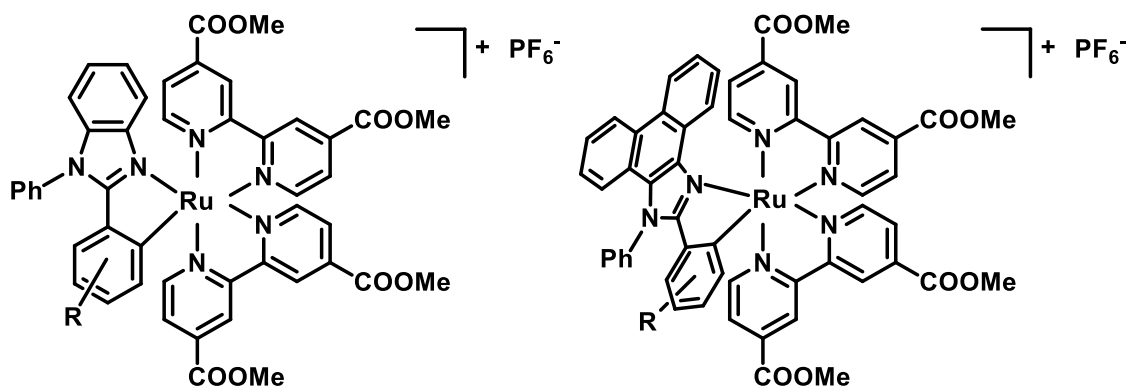

**Scheme 1.** Structures of complexes with 1-phenyl-2-arylbenzimidazoles (left) and 1-phenyl-2-arylphenanthroimidazoles (right).

A series of complexes of the composition  $\text{Ru}(\text{dmdcbp})_2(\text{L-X})\text{PF}_6$ , where X is various substituents in the aryl fragment of 1-phenyl-2-arylbenzimidazole (-H, -Me, -CF<sub>3</sub>, -F, -Cl, -NMe<sub>2</sub>, -CN, -NO<sub>2</sub>, -OMe), have been studied. The structure and composition of the obtained complexes were established by NMR, MALDI, and SC-XRD methods, and the optical and electrochemical properties were studied by CV, UV-vis spectra, and luminescence spectroscopy. Upon increasing the donor substituent, a bathochromic shift of the absorption and emission maxima and a decrease in the redox potential occur, with the  $\sigma$ -donor substituent -Me having a greater effect than the  $\pi$ -donor -OMe. The complexes exhibit phosphorescence in the near infrared region, and the excited state lifetime decreases upon increasing the donor substituent. Photoanodes sensitized with some compounds were tested in a Grätzel cell [1].

To study the influence of the conjugated ligand system on the properties of the dyes with different substituents in the aryl fragment of 1-phenyl-2-arylphenanthroimidazole (-H, -NO<sub>2</sub>, -OMe, -Me, -F) have been investigated. The increase of the conjugated system does not lead to an increase in the extinction coefficients of the compounds; however, it results in a slight shift of the absorption and emission bands, an increase in the redox potential by 0.04 V, and a twofold decrease in the excited state lifetimes.

## References

[1] *Dalton Transactions*. **2020**, 49(46), 16935-16945.

## Acknowledgements

The authors are grateful the N.D. Zelinsky Institute of Organic Chemistry, specifically Dr. Oleg Rakitin and Dr. Ekaterina Knyazeva for photovoltaics measurements

# NANOSIZED CeO<sub>2</sub>: SYTHESIS FROM POLYNUCLEAR COORDINATION COMPOUNDS AND STUDY OF ITS CATALYTIC PROPERTIES

*Nikandrov N.M.<sup>1</sup>, Spasskaya S.A.<sup>2</sup>, Tsybarenko D.M.<sup>2</sup>*

<sup>1</sup> Faculty of Materials Science, Moscow State University, Moscow, Russia

<sup>2</sup> Department of Chemistry, Moscow State University, Moscow, Russia  
Postgraduate

[Nikita\\_nikandrov@inbox.ru](mailto:Nikita_nikandrov@inbox.ru)

Cerium dioxide nanoparticles are of a great interest due to their unique physical and chemical properties. Due to the high concentration of oxygen vacancies in CeO<sub>2</sub> it can be used as a catalyst in oxidation reactions. Using nanoscale CeO<sub>2</sub> as a support for active phase, for example Pd, allows one to obtain catalysts for diverse applications. One of the most important challenges is the ability to control particle size distribution and specific surface area of the obtained nanoparticles. This problem can be solved using cerium pre-organized metal-organic compounds as precursors for CeO<sub>2</sub> nanoparticles synthesis. Polynuclear cerium carboxylates, namely Ce<sub>6</sub>O<sub>8</sub>(piv)<sub>8</sub>(deta)<sub>4</sub> and Ce<sub>6</sub>O<sub>4</sub>(OH)<sub>4</sub>(piv)<sub>12</sub>(deta)<sub>2</sub> (Hpiv = pivalic acid, deta = diethylenetriamine), are of the most interest due the fluorite-like structure of [Ce<sub>6</sub>O<sub>8</sub>]<sup>8+</sup> or [Ce<sub>6</sub>O<sub>4</sub>(OH)<sub>4</sub>]<sup>12+</sup> cores, which are isomorphous to CeO<sub>2</sub> [1]. One of the most promising methods of obtaining catalysts, supported on CeO<sub>2</sub>, is pyrolysis of metal-organic frameworks, impregnated with active phase precursors. It provides more uniform distribution of active phase on the surface of CeO<sub>2</sub>.

In this work nanodisperse CeO<sub>2</sub> was obtained in solvothermal conditions from Ce<sub>6</sub>O<sub>8</sub>(piv)<sub>8</sub>(deta)<sub>4</sub> and Ce<sub>6</sub>O<sub>4</sub>(OH)<sub>4</sub>(piv)<sub>12</sub>(deta)<sub>2</sub> precursors with S<sub>BET</sub> = 97 m<sup>2</sup>/g and particle size of ~2 nm. The process of Ce<sub>6</sub>O<sub>8</sub>(piv)<sub>8</sub>(deta)<sub>4</sub> hydrolysis was for the first time investigated *in situ* using laboratory equipment in an experiment of total X-ray scattering and pair distribution function (PDF) analysis [2]. It was found that heating the precursor up to 120 °C leads to gradual growth of a [Ce<sub>x</sub>O<sub>y</sub>] core size and crystallization of nanosized CeO<sub>2</sub> instead of thermal decomposition of the precursor.

Pd nanoparticles were deposited on the obtained nanoscale CeO<sub>2</sub> using incipient wetness impregnation using H<sub>2</sub>PdCl<sub>4</sub> solution. The obtained Pd/CeO<sub>2</sub> catalyst was tested in a reaction of selective phenylacetylene hydrogenation. Selectivity towards styrene was 92% at 66% conversion of phenylacetylene, which is higher than in Pd/CeO<sub>2</sub> catalysts, in which CeO<sub>2</sub> was obtained from Ce (III) and Ce (IV) inorganic salts.

CuO/CeO<sub>2</sub> and Fe<sub>2</sub>O<sub>3</sub>/CeO<sub>2</sub> catalysts were obtained from cerium anionic MOF, namely Ce-MOF ([[(CH<sub>3</sub>)<sub>2</sub>NH<sub>2</sub>]<sub>2</sub>[Ce<sub>2</sub>(BDC)<sub>4</sub>(DMF)<sub>2</sub>] (H<sub>2</sub>BDC = terephthalic acid, DMF = N,N-dimethylformamide [3])), impregnated with solutions of Cu(NO<sub>3</sub>)<sub>2</sub> and Fe(NO<sub>3</sub>)<sub>3</sub> in DMF. The presence of dimethylammonium cations in the MOF's voids allows conducting cation exchange reactions and absorb metal cations more effectively. According to the EDX data CuO and Fe<sub>2</sub>O<sub>3</sub> contents in the CuO/CeO<sub>2</sub> and Fe<sub>2</sub>O<sub>3</sub>/CeO<sub>2</sub> catalysts were 5,85 wt% and 5,81% respectively, which is close to the intended content of 6 wt% of active phase.

## References

- [1] Eur. J. Inorg. Chem. **2019**, 26, 3103
- [2] J. Appl. Crystallogr. **2022**, 55(4), 890
- [3] ACS Omega **2023**, 8(50), 4839

## Acknowledgements

This work was supported by the Russian Science Foundation (project No 22-73-10089).

## COPPER(II) COMPLEXES AS PRECURSORS OF EFFECTIVE HYDROGENATION CATALYSTS

*Novikov D.V.*<sup>1,2</sup>, *Koshenskova K.A.*<sup>2</sup>, *Nebykov D.N.*<sup>3</sup>, *Eremenko I.L.*<sup>2</sup>, *Lutsenko I.A.*<sup>2</sup>

<sup>1</sup> Mendeleev University of Chemical Technology of Russia, Moscow, Russia

<sup>2</sup> Institute of General and Inorganic Chemistry of the Russian Academy of Sciences, Moscow, Russia

<sup>3</sup> Volgograd State Technical University, Volgograd, Russia

Student

[dima.novikov.2004@mail.ru](mailto:dima.novikov.2004@mail.ru)

In the chemical industry catalysts based on platinum group metals with high activity, but at the same time high cost are mainly used for hydrogenation processes, therefore, the search for more affordable analogues, for example, based on d-metals such as Zn, Co, Cu, Fe [1,2], is an urgent task.

The purpose of this study was to develop approaches for the synthesis of copper(II) coordination compounds with furan (Hfur)- and thiophene (Htio)-carboxylic acid anions in combination with N-donor ligands (4-phenylpyridine (phpy), imidazole (Im)), to determine their structure and study their catalytic activity in hydrogenation processes bonds –C=C– using the example of dicyclopentadiene (DCPD).

In the case of using imidazole as an N-donor ligand, mononuclear complexes of the composition  $[\text{Cu}(\text{fur})_2(\text{Im})_2(\text{H}_2\text{O})] \cdot \text{solv}$  (fur- = 2fur- (**1**, **2**), 3fur- (**3**); solv = MeCN (**1**)) were obtained. When using 4-phenylpyridine in various synthetic variations, it is possible to form as a mononuclear  $[\text{Cu}(\text{L})_2(\text{phpy})_2\text{H}_2\text{O}] \cdot \text{solv}$  (L= 2fur- (**4**), 3fur- (**5**), tio- (**6**)); solv = phpy (**4**, **5**), binuclear  $[\text{Cu}_2(\text{L})_4(\text{phpy})_2]$  (L= 2fur- (**7**), 3fur- (**8**), tio- (**9**), and mixtures of both reaction products (Fig. 1). All compounds are isolated as single crystals, their structure is determined by the XRD method, purity is confirmed by the methods of elemental analysis and XRD. The catalytic activity of **1-3**, **5** was investigated during the restoration of the DCPD double bond.

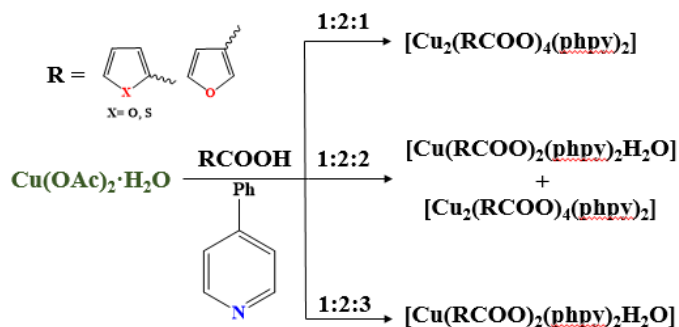

**Figure 1.** Scheme of synthesis of complexes **4-9**.

According to the results of the experiments, it was found that all the studied catalysts based on the obtained complexes exhibit high selectivity (up to 100%) under conditions of continuous hydrogenation, even at high conversion values (up to 96%) and an excess of hydrogen. It should be noted that for the  $\text{CuCl}_2$  comparison sample, the DCPD conversion did not exceed 7%.

This work was financially supported by the Russian science foundation (project 22-13-00175).

### References

- [1] *Polyhedron* **2023**, 230, 116208  
 [2] *Polyhedron* **2024**, 248, 116744

# STRUCTURE AND MAGNETIC PROPERTIES OF Co(II) AND Mn(II) POLYMERS WITH ANIONS OF UNSATURATED MALONIC ACIDS AND BRIDGING N-DONOR LIGANDS

*Novikova V.A.<sup>1,2</sup>, Zorina-Tikhonova E.N.<sup>1</sup>, Efimov N.N.<sup>1</sup>, Vologzhanina A.V.<sup>3</sup>, Eremenko I.L.<sup>1,3</sup>*

<sup>1</sup> N.S. Kurnakov Institute of General and Inorganic Chemistry RAS, Moscow, Russia

<sup>2</sup> Moscow State University, Moscow, Russia

<sup>3</sup> A.N. Nesmeyanov Institute of Organoelement Compounds RAS, Moscow, Russia  
Student

[veronikanovikova02@mail.ru](mailto:veronikanovikova02@mail.ru)

The chemistry of cobalt and manganese coordination compounds is interesting not only for the architectural variety of compounds, but also for the functional properties that these compounds exhibit, for example magnetic. Scientists are paying close attention to the switchable or tuned magnetic properties that appear as a result of external influence on the sample. For example, during UV irradiation, when the [2+2]-photocycloaddition reaction occurs between the unsaturated bonds of the ligands [1,2].

We obtained a series of cobalt(II) and manganese(II) coordination polymers:  $\{[\text{Co}(\text{H}_2\text{O})(\text{bpy})(\text{Cinam})] \cdot \text{H}_2\text{O} \cdot \text{DMF} \cdot \text{MeCN}\}_n$  (1),  $[\text{Co}(\text{H}_2\text{O})(\text{bpa})(\text{Cinam})]_n$  (2),  $[\text{Co}(\text{H}_2\text{O})(\text{bpe})(\text{Cinam})]_n$  (3),  $\{[\text{Co}_2(\text{H}_2\text{O})_4(\text{bpe})(\text{Cinam})_2] \cdot 2\text{H}_2\text{O}\}_n$  (4):  $\{[\text{Mn}(\text{CinAm})(\text{bpa})(\text{H}_2\text{O})] \cdot \text{DMF} \cdot 2\text{H}_2\text{O}\}_n$  (5) и  $\{[\text{Mn}_2(\text{H}_2\text{O})_4(\text{bpe})(\text{Cinam})_2] \cdot 2\text{H}_2\text{O}\}_n$  (6) with cinnamylidenemalonic acid anions ( $\text{H}_2\text{CinAm}$ ) and bridging N-donor ligands 4,4'-bipyridyl (bpy), 1,2-bis(4-pyridyl)ethane (bpa), 1,2-bis(4-pyridyl)ethylene (bpe).

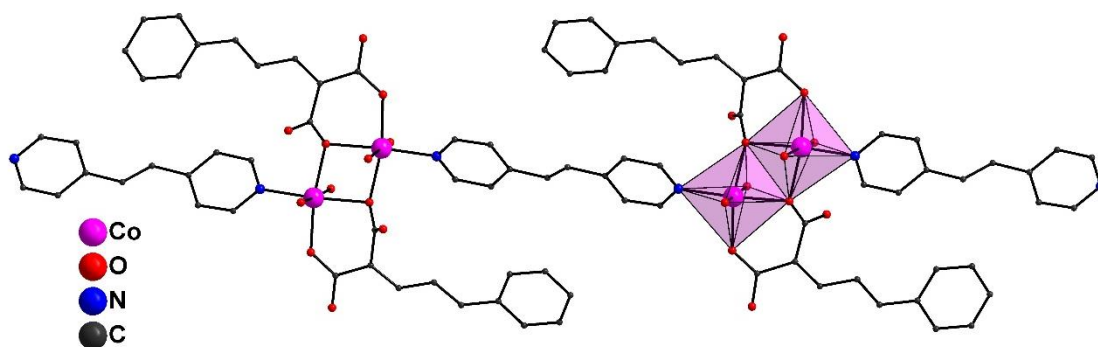

**Figure 1.** The fragment of  $\{[\text{Co}_2(\text{H}_2\text{O})_4(\text{bpe})(\text{Cinam})_2] \cdot 2\text{H}_2\text{O}\}_n$  (4)

Compound **4** was stepwise prepared from compound **3** by solvothermal synthesis by adding excess of acid and lithium hydroxide hydrate. The remaining compounds were synthesized by slow mixing at room temperature in air. It is interesting to note that despite the difference in synthesis procedures, compounds **4** and **6** are isostructural.

With anions of allylmalonic acid ( $\text{H}_2\text{Amal}$ ), the compounds of cobalt(II)  $[\text{Co}_2(\text{H}_2\text{O})_2(\text{Amal})_2(\text{bpy})]_n$  (**7**) and manganese(II)  $[\text{Mn}_2(\text{H}_2\text{O})_2(\text{Amal})_2(\text{bpe})]_n$  (**8**) were obtained.

For all the obtained compounds, studies were carried out to establish the possibility of the [2+2]-photocycloaddition reaction. The magnetic properties of compounds **1** and **8** were studied.

## References

- [1] *Inorg. Chem.* **2019**, *58*(21), 14440–14448
- [2] *Chem. Commun.* **2015**, *51*, 15358-15361

# DESIGN AND SYNTHESIS OF HIGHLY EMISSIVE, WATER-SOLUBLE CYCLOMETALATED IRIDIUM(III) COMPLEX

*Nykhrikova E.V.<sup>1,2</sup>, Bezzubov S.I.<sup>1</sup>*

<sup>1</sup>Kurnakov Institute of General and Inorganic Chemistry RAS, Moscow, Russia

<sup>2</sup>Moscow State University, Moscow, Russia

Student

[nykhrikova.kate@yandex.ru](mailto:nikhrikova.kate@yandex.ru)

In recent decades cyclometalated iridium(III) complexes have attracted interest of researchers due to their outstanding photophysical properties. In particular, such complexes can be widely applied as anticancer agents in medicine, as emitters in OLEDs, in sensor systems, as catalysts and as photosensitizers in solar cells.

In a previous work, cyclometalated benzimidazole complexes with different substituents were investigated [1]. It was shown that these ligands allow to vary photophysical properties through the rational selection of substituents. Selection of ligands makes it possible to obtain complexes with the desired solubility/absorption/emission properties.

In this work, a bis-cyclometalated iridium (III) complex containing 4 carboxyl groups that endow its relatively high solubility in water (compared to analogues) was synthesized (scheme 1). The complex was characterized by single-crystal and powder X-ray diffraction and <sup>1</sup>H NMR spectroscopy. The influence of acid and base on its absorption and emission properties was studied. In particular, addition of TBAOH results in a blue shift of absorption maxima by approx. 30 nm. The fully protonated form of the complex shows high luminescence efficiency (QY=37.8% rel. to Ru(bpy)<sub>3</sub>). Increased solubility in water along with its high sensitivity to acidity support the potential application of the complex in bioimaging.

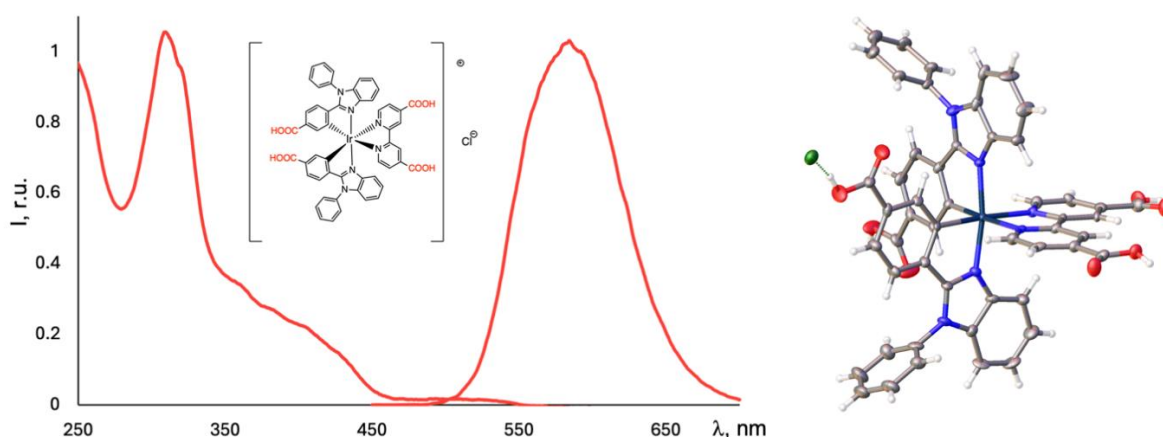

**Scheme 1.** Absorption and emission spectra and molecular structure of the studied complex.

## References

[1] *Dalton Trans.* **2023**, 52, 16261

# CATIONIC OR NEUTRAL: DEPENDANCE OF PHOTOPHYSICAL PROPERTIES OF BIS-ALKYNYLPHOSPHONIUM Pt(II) COMPLEXES ON ANCILLARY LIGAND

*Paderina A.V.*<sup>1</sup>, *Sizova A.A.*<sup>1</sup>, *Grachova E.V.*<sup>1</sup>

<sup>1</sup>St Petersburg University, St. Petersburg, Russia

PhD student

[a.paderina@spbu.ru](mailto:a.paderina@spbu.ru)

Pt(II) complexes are widely studied nowadays due to their rich photoluminescent properties. One of the ways to vary the luminescence is introduction of donor-linker-acceptor systems with intramolecular charge transfer as ligands for platinum(II) metalcenter. This approach was used in our previous work on bis-alkynylphosphonium complexes in cis-configuration, leading to stimuli-responsive and non-linear optical properties <sup>1</sup>.

According to the literature <sup>2-4</sup>, the *trans*- arrangement of alkynyl ligands in the bis-alkynyl Pt(II) systems is more favorable for  $\pi$ -conjugation along the molecular axis. In the case of alkynylphosphonium ligands  $P_i$ , that belong to the donor- $\pi$ -linker-acceptor (D- $\pi$ -A) systems, this can promote emission characteristics of corresponding Pt(II) complexes.

Herein we report the synthesis and photophysical properties of two Pt(II) complexes series of general formula *trans*-[Pt( $P_i$ )<sub>2</sub>(PPh<sub>3</sub>)<sub>2</sub>]OTf<sub>2</sub>, **1P-3P** and *trans*-[Pt( $P_i$ )<sub>2</sub>(CN)<sub>2</sub>], **1CN-3CN**.

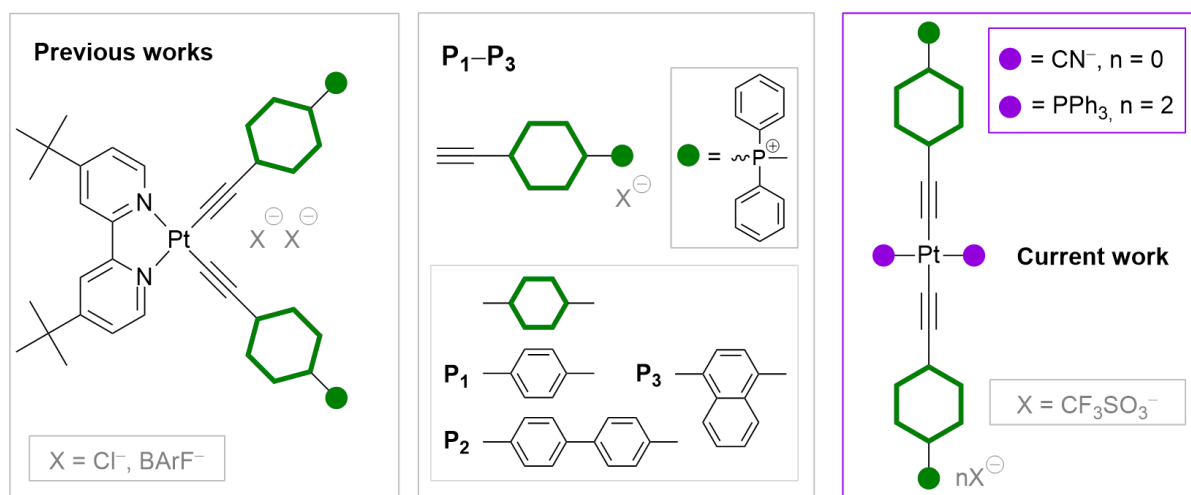

**Scheme 1.** Alkynylphosphonium salts and complexes based on them.

Introduction of neutral or negatively charged ancillary ligands lead to the different charge of the final complex. Moreover, together with strongly accepting phosphonium moiety they influence the photophysical properties of yielded compounds. Synthesis, crystal structures and luminescence both in solution and solid state are discussed.

## References

- [1] *Inorg. Chem.*, **2023**, 62, 18056
- [2] *Eur. J. Inorg. Chem.*, **2011**, 2011, 3248
- [3] *J. Phys. Chem. B*, **2004**, 108, 4969
- [4] *Dalt. Trans.*, **2005**, 2760

## Acknowledgements

This work was supported by the Russian Science Foundation (project No 24-13-00024). The work was carried out using equipment of Centres for Magnetic Resonance, for Chemical Analysis and Materials Research, and X-ray Diffraction Centres (Research Park of St.Petersburg State University)

FEATURES OF PHASE FORMATION, DIELECTRIC PROPERTIES, XPS SPECTROSCOPY STUDY  
OF PYROCHLORE-TYPE  $\text{Bi}_2\text{Cr}_{1/6}\text{Mn}_{1/6}\text{Fe}_{1/6}\text{Co}_{1/6}\text{Ni}_{1/6}\text{Cu}_{1/6}\text{Ta}_2\text{O}_{9+\Delta}$ .

*K.N. Parshukova*<sup>1</sup>, *B.A. Makeev*<sup>2</sup>, *N.A. Sekushin*<sup>3</sup>, *M.G. Krzhizhanovskaya*<sup>4</sup>, *A.V. Koroleva*<sup>4</sup>,  
*N.A. Zhuk*<sup>1</sup>

<sup>1</sup>Syktvykar State University, Syktvykar, Russia

<sup>2</sup>Institute of Geology of the Komi Science Center UB RAS, Syktvykar, Russia

<sup>3</sup>Institute of Chemistry of the Komi Science Center UB RAS, Syktvykar, Russia

<sup>4</sup>Saint Petersburg State University, St. Petersburg, Russia

Student

[Kristinaparshukova17@gmail.com](mailto:Kristinaparshukova17@gmail.com)

Bismuth-containing pyrochlores exhibit a wide range of practically useful properties, among which are dielectric properties (low dielectric losses and high dielectric constant, adjustable temperature coefficient of capacitance), catalytic properties in the UV and visible range. A useful addition is the relatively low synthesis temperature and thermal stability of bismuth pyrochlores. In the crystal structure of pyrochlore  $\text{A}_2\text{B}_2\text{O}_6\text{O}'$ , two interpenetrating and weakly interacting sublattices are distinguished. The cationic sublattice  $\text{A}_2\text{O}'$  is similar to the structure of anticitobalite, the second  $\text{B}_2\text{O}_6$  forms a three-dimensional framework of vertex-linked octahedrons. Octahedral positions B are occupied by relatively small cations ( $\text{Ta}^{+5}$ ,  $\text{Ru}^{+4}$ ,  $\text{Zr}^{+4}$ ,  $\text{Sb}^{+5}$ ), larger ions ( $\text{Bi}^{3+}$ ,  $\text{Sm}^{+3}$ ,  $\text{Pb}^{+2}$ ) are distributed in eight-coordinated positions A. The flexibility of the pyrochlore crystal structure to cation substitutions in the bismuth/tantalum sublattices and to oxygen vacancies in the  $\text{A}_2\text{O}'$  sublattice makes it possible to control their functional properties. Currently, pyrochlores based on bismuth tantalate and niobate are being actively studied due to their promising dielectric and catalytic properties. A feature of the pyrochlores under consideration is the unfilled bismuth sublattice due to the  $6s^2$  electron pair and the ability of transition element ions to simultaneously reside in the cationic sublattices of bismuth ( $\text{A}_2\text{O}'$ ) and tantalum (niobium) ( $\text{B}_2\text{O}_6$ ), causing relaxation processes in ceramics. Studies of pyrochlores based on bismuth tantalate containing 3d transition ions (Cu, Ni, Fe, Cr, Co, Zn) have shown that porous ceramics are formed with low dielectric losses and moderate values of dielectric permittivity.

It was established by XRD, that the ceramics of the nominal composition  $\text{Bi}_2\text{Cr}_{1/6}\text{Mn}_{1/6}\text{Fe}_{1/6}\text{Co}_{1/6}\text{Ni}_{1/6}\text{Cu}_{1/6}\text{Ta}_2\text{O}_{9+\Delta}$  contained trace amounts of bismuth orthotantalate impurity, regardless of the synthesis conditions. The phase-clean sample was obtained with a deficiency of bismuth atoms in the  $\text{Bi}_{2-x}\text{Cr}_{1/6}\text{Mn}_{1/6}\text{Fe}_{1/6}\text{Co}_{1/6}\text{Ni}_{1/6}\text{Cu}_{1/6}\text{Ta}_2\text{O}_{9+\Delta}$  bismuth sublattice. The complex oxide crystallizes in the pyrochlore structural type (sp. gr. Fd-3m,  $a=10.48106 \text{ \AA}$ ). The study of the process of phase formation of multicomponent pyrochlore in the course of solid-phase synthesis showed that the precursor of the pyrochlore phase is bismuth orthotantalate. Of all the precursors, cobalt and nickel oxides are the last to enter the chemical reaction (at 850-900 °C). Intermediate phases in the course of synthesis are complex oxides  $\text{Bi}_{16}\text{CrO}_{27}$ ,  $\text{Bi}_{25}\text{FeO}_{40}$ ,  $\text{BiTaO}_4$ ,  $\text{Bi}_3\text{TaO}_7$ ,  $\text{CoTa}_2\text{O}_6$ . During the evolution of the pyrochlore phase, a nonmonotonic change in the unit cell parameter is observed. Phase-clean pyrochlore is synthesized at a temperature of 1000-1050 °C. Ceramics is characterized by a porous, loose microstructure with an average grain size of 0.5-1 microns; the porosity of a sample calcined at 1050 °C is 19 percent. According to the XPS data, the transition element ions in pyrochlore are predominantly in the Cr(III), Fe(III), Mn(II), Co(II), Ni(II), Cu(II) states. At room temperature, the permittivity and dielectric loss tangent of  $\text{Bi}_{2-1/3}\text{Cr}_{1/6}\text{Mn}_{1/6}\text{Fe}_{1/6}\text{Co}_{1/6}\text{Ni}_{1/6}\text{Cu}_{1/6}\text{Ta}_2\text{O}_{9+\Delta}$  are ~46 and ~0.004 at 1 MHz, respectively. An equivalent circuit is proposed that simulates the electrical properties of the sample.

# STRUCTURAL TRANSFORMATIONS IN PYROCHLORE-LIKE SOLID SOLUTIONS BASED ON $Y_2FeTaO_7$

*Popova E.F.*<sup>1</sup>, *Egorysheva A.V.*<sup>1</sup>, *Ellert O.G.*<sup>1</sup>, *Kirdyankin D.I.*<sup>1</sup>, *Imshennik V.K.*<sup>2</sup>, *Kulikova E.S.*<sup>3</sup>,  
*Khramov E.V.*<sup>3</sup>

<sup>1</sup>Kurnakov Institute of General and Inorganic Chemistry of the Russian Academy of Sciences,  
Moscow, Russia

<sup>2</sup>N. N. Semenov Research Center for Chemical Physics, Russian Academy of Sciences, Moscow,  
Russia

<sup>3</sup>National Research Centre "Kurchatov Institute", Moscow, Russia

PhD student

[lenapopova11a@yandex.ru](mailto:lenapopova11a@yandex.ru)

In recent years, complex transition metal oxides have been interested due to its unusual magnetic properties [1-2]. Modification of such materials by iso- or heterovalent substitution can cause to structural transformations that can change the type of interaction in magnetic sublattices, lead to the appearance of competing exchange interactions and, as a result, to the emergence of important and non-trivial results. This work is devoted to the synthesis of solid solutions based on  $Y_2FeTaO_7$ , the study of their structural and magnetic properties.

A number of layered solid solutions of  $Y_{2-x}Fe_{1+x}TaO_7$  were synthesized by the co-precipitation method followed by annealing of the precipitate. It has been established that a solid solution of  $Y_{2-x}Fe_{1+x}TaO_7$  exists in the region  $x = 0-0.2$ . Previously it was shown that  $Y_{2-x}Fe_{1+x}TaO_7$  is a layered compound with a pyrochlore-like structure, sp. gr.  $R-3$ . Analysis of the synchrotron X-ray diffraction data showed that the entry of additional iron ions into  $Y_{2-x}Fe_{1+x}TaO_7$  leads to a structural transition of sp. gr.  $R-3 \rightarrow$  sp. gr.  $P3_121$  at  $x=0.1$  (fig. 1). Unlike structure with sp. gr.  $R-3$ , there are three nonequivalent positions in the Fe/Ta–O layer of polyhedra over which iron ions can be distributed in structure with sp. gr.  $P3_121$ . By the method of Mossbauer spectroscopy, it was found that the iron ions in  $Y_{2-x}Fe_{1+x}TaO_7$  enter only into the positions of the Fe/Ta–O polyhedron layer, and the vacant positions of  $Y^{3+}$  are occupied by  $Ta^{5+}$  ions.

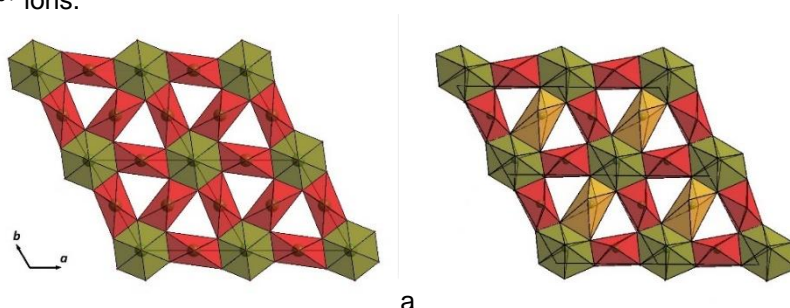

**Figure 1.** Layers of Fe/Ta–O polyhedra in  $Y_2FeTaO_7$  (a) and  $Y_{2-x}Fe_{1+x}TaO_7$  (b).

The synthesis of pyrochlore-like compounds in the Y-Mg-Fe-Ta-O system was carried out by the sol-gel method. It is shown that the solid solution exists in a wide range of compositions:  $Y_{2-x}Mg_xFeTaO_{7-\delta}$  ( $x=0-0.15$ ),  $Y_{2-x}Mg_xFe_{1-x/2}Ta_{1+x/2}O_{7-\delta}$  ( $x=0-0.15$ ),  $Y_2Fe_{1-x}Mg_xTaO_{7-\delta}$  ( $x=0-0.3$ ),  $Y_2Fe_{1-3/2x}Mg_xTa_{1+x/2}O_{7-\delta}$  ( $x=0-0.3$ ). The LeBel method established the affiliation of these compounds to the same sp. gr.  $P3_121$ . Analysis of X-ray diffraction data showed that despite the ionic radii difference,  $Mg^{2+}$  enters the octahedral positions of  $Fe^{3+}/Ta^{5+}$ .

The analysis of the Raman spectra confirmed the similarity of the structures of solid solutions with iso- and heterovalent substitution (sp. gr.  $P3_121$ ) and  $Y_2FeTaO_7$  (sp. gr.  $R-3$ ). The presence of  $Fe^{4+}$  along with  $Fe^{3+}$  in  $Y_2Fe_{1-x}Mg_xTaO_{7-\delta}$  and  $Y_{2-x}Fe_{1+x}TaO_7$  was confirmed by the XANES method. The study of XANES spectra at the  $L_{III}$ -edge of Ta has shown the presence of some fraction of  $Ta^{4+}$  along with  $Ta^{5+}$ .

The magnetic properties of solid solutions with a different deviation from the stoichiometric  $Y_2FeTaO_7$  have been studied. It was found that frustrated 2D-sublattices of kagome-type are formed in which in  $Fe^{3+}$  ions are coupled by short-range order antiferromagnetic interactions and a transition to spin glass state is observed at  $T_g > 5$  K. The existence of a ferrimagnetic transition above room temperature has been established.

## References

- [1] *Phys. Rev. B.* **2010**, *81*, 014417
- [2] *Magn. Magn. Mater.* **2020**, *513*, 167226



# SYNTHESIS OF POLYNUCLEAR MAGNETIC COPPER COMPLEXES BY CONTROLLED HYDROLYSIS

*Pushikhina O.S.<sup>1</sup>, Kozlyakova E.S.<sup>1</sup>, Karpova E.V.<sup>1</sup>*

<sup>1</sup>Moscow State University, Moscow, Russia

PhD Student

[pushikhina\\_chem@mail.ru](mailto:pushikhina_chem@mail.ru)

Polynuclear carboxylates of copper (II), in which copper ions are connected via bridge ligands, are of interest from the point of view of studying the phenomena of intramolecular magnetic exchange and obtaining magnetic structural correlations. Magnetic interaction in such complexes can be carried out in various ways and depends on the coordination geometry of copper ion, the distance Cu ... Cu, on the valence corners of the bridge atoms and bond lengths between them, the total length of the metal-ligand bridge. The combination of the coordination capabilities of copper (II) and ligands gives rise to high variability in structural terms. So, compounds both on the basis of insulated copper ions and 3D-extended structures can be obtained.

The structure of haloacetate complexes depends on the synthesis methodology. For example, the authors of [1] obtained  $\text{Cu}_2(\text{CCl}_3\text{COO})_4(\text{CCl}_3\text{COOH})_2$  – its structure consists of dinuclear «paddle wheel» fragments. In [2] was investigated the compound  $\text{Cu}(\text{CCl}_3\text{COO})_2(\text{H}_2\text{O})_3$ , which has a mononuclear molecular structure. An increase in the pH of the reaction mixture leads to partial hydrolysis of copper ions, as a result of which the formation of additional ways of the metal centers bonding. So, our work [3] describes the compound  $\text{Cu}_2(\text{CCl}_3\text{COO})_3(\text{OH})(\text{H}_2\text{O})_4 \cdot \text{H}_2\text{O}$ , which crystallizes in the absence of acid. The structure of this compound consists of molecular and chain fragments.

When the reaction mixture is dilute, the processes of hydrolysis prevails, then not solvation, and the new compound  $\text{Cu}_3(\text{CCl}_3\text{COO})_2(\text{OH})_4$  are formed. In its structure the copper (II) ions are connected into layers through  $\mu_3\text{-OH-}$  and  $\mu_2\text{-RCOO-}$  ligands (Fig. 1). The structure includes two crystallographically independent copper atoms – Cu1 and Cu2.

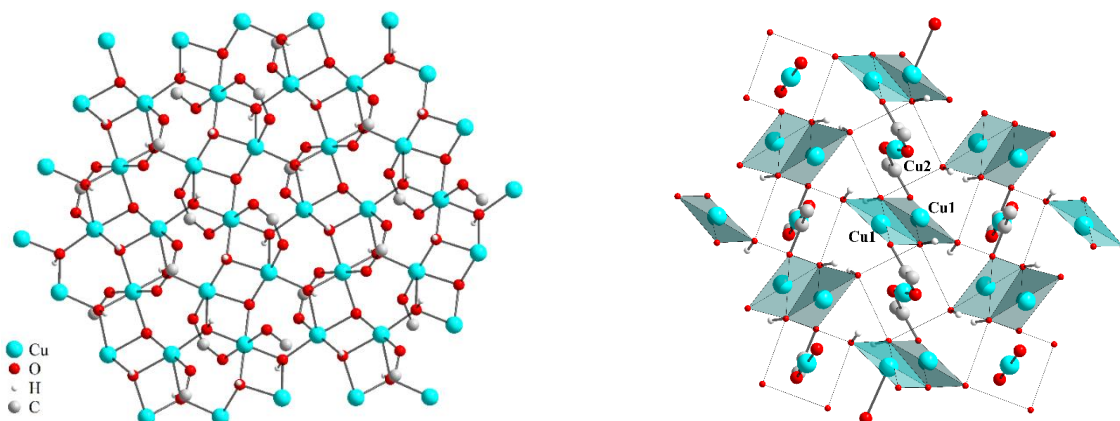

**Figure 1.** A fragment of the structure of  $\text{Cu}_3(\text{CCl}_3\text{COO})_2(\text{OH})_4$  (left) and  $[\text{Cu1Cu1}]$  «dimers» having a supposed magnetic exchange (right). Trichloromethyl groups are hidden.

Thus, we developed a methodology for obtaining a single phase polycrystalline sample of the new compound  $\text{Cu}_3(\text{CCl}_3\text{COO})_2(\text{OH})_4$ , its crystal structure was refined. The temperature dependencies of magnetic susceptibility were measured. The characterization using X-ray diffraction and spectral methods, as well as the analysis of the thermal stability, were carried out.

## References

- [1] *Dalton Trans.* **2000**, 13, 2067
- [2] *Bull. Chem. Soc. Jpn.* **1987**, 60, 2983
- [3] *Mend. Comm.* **2022**, 32(2), 208

## Acknowledgements

This work was supported by the Russian Science Foundation (project № 22-72-10034). Research was carried out under partial support of MSU Shared Research Equipment Center «Technologies for obtaining new nanostructured materials and their complex study», National Project «Science» and MSU Program of Development».

# CYANIDO-BRIDGED HETEROMETALLIC Pt(II)-Au(III) COMPLEXES: SYNTHESIS AND PHOTOPHYSICAL PROPERTIES

*Safronova S.D.<sup>1</sup>, Luginin M.E.<sup>1</sup>, Grachova E.V.<sup>1</sup>*

<sup>1</sup> St Petersburg University, St. Petersburg, Russia

Student

[st097764@student.spbu.ru](mailto:st097764@student.spbu.ru)

Supramolecular heterometallic systems with outstanding photophysical properties can be used as a substrate for the creation of new phosphorescent materials, which can find their application in OLED devices as organometallic emitters. Nowadays, there is a number of described heterometallic transition metal complexes[1,2]. However, cyanido-bridged Pt(II)-Au(III) compounds have not been described so far. Pt(II) and Au(III) are isoelectronic ions, compounds with  $d^8$  configuration are square planar and, in the case of platinum(II), have rich and tunable photophysical properties particularly because of the ability to participate in Pt-Pt and  $\pi$ - $\pi$ -stacking interactions. Au(III) is known for its poor photophysical properties, so it is interesting how the presence of such an important class of chromophores as square-planar platinum(II) complexes will affect the photophysical characteristics of Au(III) in heterometallic complexes. Such complexes can exhibit supramolecular aggregation due to metallophilic interactions and/or  $\pi$ -stacking, which helps to tune the photophysical properties of the aggregates in the solid phase. The aim of the present work is to develop a methodology and synthesis of a series of heterometallic cyanido-bridged complexes of Pt(II)- Au(III) with cyclometallating tridentate ligands and explore their photophysical properties.

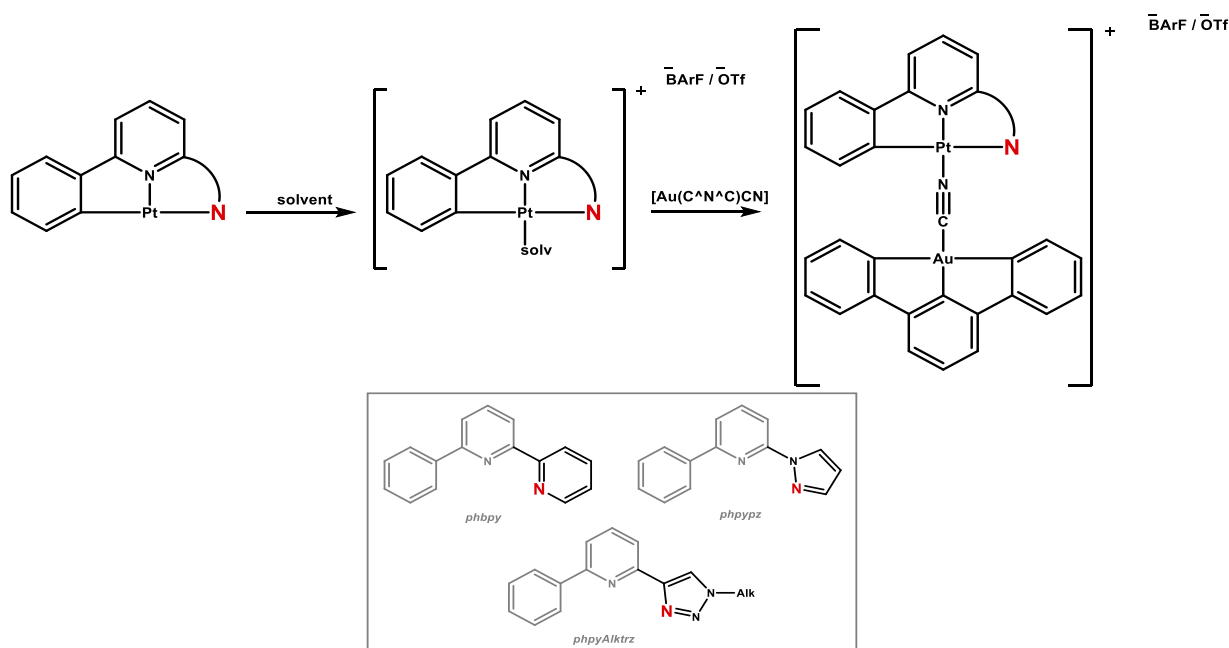

**Scheme 1.** General scheme of synthesis of heterometallic cyanido-bridged complexes with different tridentate ligands.

The research was carried out using the equipment of the resource centers of the St Petersburg University Research Park “Magnetic Resonance Research Methods” and “Methods of Analysis of Matter Composition”.

## References

- [1] *Inorg. Chem.* **2019**, *58*(3), 1988-2000
- [2] *Inorg. Chem.* **1999**, *38*, 606-612

## Acknowledgements

This work was supported by the Russian Science Foundation (project № 21-13-00052).

# SYNTHESIS AND CYTOTOXICITY STUDY OF FERROCENYLMETHYL-L-METHIONINE AND ITS 2,2'-BIPYRIDINE / 1,10-PHENANTHROLINE BASED COPPER(II) COMPLEXES

*Savinykh P.E.*<sup>1,3</sup>, *Golubeva Yu.A.*<sup>1,2</sup>, *Ermakova E.A.*<sup>1,2</sup>

<sup>1</sup> Nikolaev Institute of Inorganic Chemistry, Novosibirsk, Russia

<sup>2</sup> Institute of Molecular Biology and Biophysics, Federal Research Center of Fundamental and Translational Medicine, Novosibirsk, Russia

<sup>3</sup> Novosibirsk State University, Department of Natural Sciences, Novosibirsk, Russia

Student

[p.savinykh@ngsu.ru](mailto:p.savinykh@ngsu.ru)

The ferrocene  $\text{Fe}(\eta^5\text{-C}_5\text{H}_5)_2$  chemistry dates back more than six decades. Since its discovery, ferrocene has demonstrated great synthetic opportunities and turned out to be attractive for chemists, biologists and physicians due to its stable sandwich structure and the capacity for reversible oxidation at physiological pH values [1]. The ability of ferrocene to cause the formation of reactive oxygen species through its oxidation is the most important feature of ferrocene, which can be used in the development of drugs for the treatment of malignant neoplasms.

The investigation of metallocenes antineoplastic activity, especially of ferrocene-containing ones, is on top of its relevancy [2]. Inasmuch as metal-based clinically approved drugs (cisplatin and its derivatives) possess severe side effects and patients often become resistant to chemotherapy, the development of less toxic anticancer medications based on essential metals is of great interest. The ferrocene derivatives are of importance for their stability in a biological medium, lipophilicity, nontoxicity and are known to exhibit antitumor, antimalarial, antifungal properties [3]. Many reports by Goswami et al. have shown that ferrocene-conjugated copper(II) complexes are efficient photocleavers of DNA in red light [3-5]. However, safety profile (selectivity indexes for non-tumor cells) of these compounds is unknown.

In the present study, the ferrocene is modified to ferrocenylmethyl-L-methionine in two steps, with formyl-ferrocene being the product after the first step [6-7] (**Scheme 1**). The obtained molecule has been used as a secondary ligand in the synthesis of mixed-ligand copper(II) complexes with 1,10-phenanthroline or 2,2'-bipyridine derivatives, namely, 1,10-phenanthroline, 4,7-dimethyl-1,10-phenanthroline, 5-chloro-1,10-phenanthroline, 2,2'-bipyridine and 4,4'-dimethyl-2,2'-bipyridine. The complexes have been characterized by elemental, single-crystal and powder X-ray diffraction analyzes, IR spectroscopy. Cytotoxic activity of complexes and ligands has been evaluated on tumor and non-tumor cell lines by means of IN Cell Analyzer 2200 using dual staining with Hoechst 33342/propidium iodide.

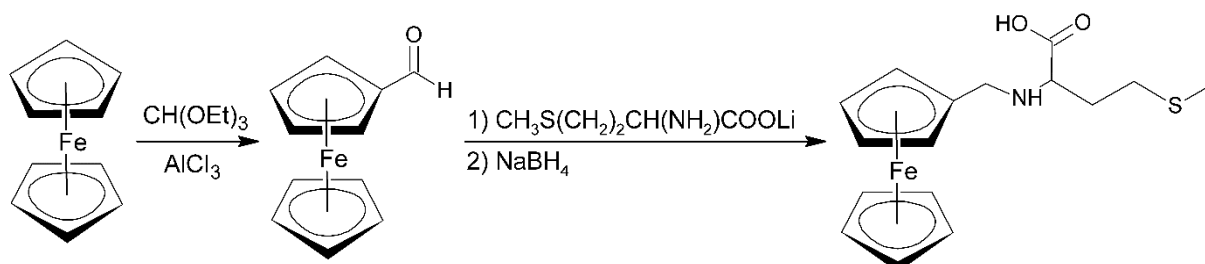

**Scheme 1.** Synthetic route of ferrocenylmethyl-L-methionine.

## References

- [1] *Izv. Akad. Nauk, Ser. Khim.* **2014**, 1
- [2] *Izv. Akad. Nauk, Ser. Khim.* **2010**, 12
- [3] *Organometallics* **2012**, 31, 3010–3021
- [4] *Inorg. Chem.* **2011**, 50, 8452–8464
- [5] *Dalton Trans.* **2014**, 43, 11988
- [6] *Synth. Commun.* **2000**, 30, 9
- [7] *Dalton Trans.* **2007**, 5148–5155

## Acknowledgements

This work has been supported by the Russian Science Foundation and the Government of the Novosibirsk region of the Russian Federation (project №24-23-20148).

## HYDRIDE CHEMISTRY AT ULTRA-HIGH PRESSURE

*Semenok D.V.<sup>1</sup>, Zhou D.<sup>1</sup>*

<sup>1</sup> Center for High Pressure Science & Technology Advanced Research  
Bldg. 8E, ZPark, 10 Xibeiwang East Rd, Haidian District, Beijing, 100193, P.R. China

PhD, post doc

[dmitrii.semenok@hpstar.ac.cn](mailto:dmitrii.semenok@hpstar.ac.cn)

Application of external pressure to a system serves as an additional degree of freedom, expanding our knowledge about stable chemical compounds and chemical reaction pathways under extreme conditions. In the presentation, I will review 10 years of research on the chemistry of polyhydride materials synthesized at high pressure from a few to hundreds GPa using diamond anvil cells.

During the 20th century, the formation of compounds between metals or nonmetals and hydrogen was thought to be limited to covalent and molecular-ionic compounds with a composition determined by the element's usual valence. For example, calcium forms the hydride  $\text{CaH}_2$  with a maximum hydrogen content of 2, and lanthanum forms  $\text{LaH}_3$ , with a maximum H-content of 3. The record for the maximum atomic hydrogen content was held by the  $\text{CH}_4$  molecule, which is critical for energy industry. Numerous attempts to build a hydrogen battery using lithium, magnesium, nickel etc. hydrides have still not reached the level of efficiency that the methane molecule has.

But at high pressure of hundreds of thousands and millions of atmospheres, the situation changes dramatically. Many metals react with hydrogen to form stable polyhydrides containing 4 ( $\text{ThH}_4$ ) [1], 6 ( $\text{YH}_6$ ) [2,3], 8 ( $\text{UH}_8$ ) [4], 9 ( $\text{PrH}_9$ ) [5], 10 ( $\text{CeH}_{10}$ ) [6], 12 ( $\text{BaH}_{12}$ ) [7], 22 ( $\text{SrH}_{22}$ ) [8] or even more hydrogen atoms per each metal atom. Of course, it is technically difficult to create and maintain such high pressure. But in recent years, there has been a tendency to reduce the stabilization pressure of these compounds, which makes it possible to see the prospects for practical applications of polyhydrides to improve the characteristics of known hydrogen batteries.

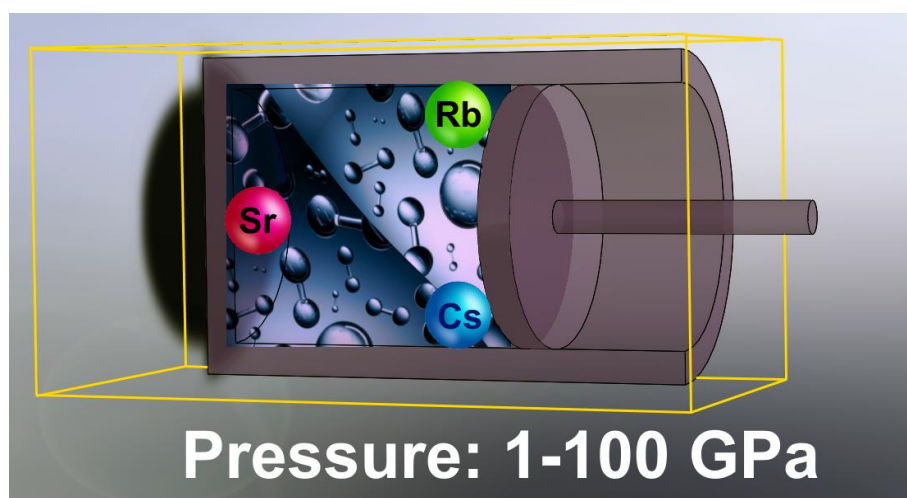

**Scheme 1.** Compression of hydrogen with alkali and alkaline earth elements (Sr, Cs, Rb etc.) leads to obtain molecular polyhydrides with extremely high H-content.

### References

- |   |  |
|---|--|
| [1] Mater. Today <b>2020</b> , 33, 36     | [5] Sci. Adv. <b>2020</b> , 6 eaax6849         |
| [2] Nat. Commun. <b>2021</b> , 12, 5075   | [6] Phys. Rev. Lett. <b>2021</b> , 127, 117001 |
| [3] Adv. Mater. <b>2021</b> , 33, 2006832 | [7] Nat. Commun. <b>2021</b> , 12, 273         |
| [4] Sci. Adv. <b>2018</b> , 4, eaat9776   | [8] Adv. Mater. <b>2022</b> , 34, 2200924      |

### Acknowledgements

D. S. and D. Z. thank National Natural Science Foundation of China (NSFC, grant No. 12350410354) and Beijing Natural Science Foundation (grant No. IS23017) for support of this research. D. Z. thanks China Postdoctoral Science Foundation (Certificate No. 2023M740204) and financial support from HPSTAR.

POLYNUCLEAR HETEROMETALLIC COMPLEXES  
OF LANTANIDES AND NICKEL WITH L-ALANINE

*Semeshkina D.D.<sup>1</sup>, Dolzhenko V.D.<sup>1</sup>*

<sup>1</sup>Moscow State University, Moscow, Russia

Student

[semeshkina.d@gmail.com](mailto:semeshkina.d@gmail.com)

Polynuclear heterometallic 3d-4f complexes may act as ion sensors, molecular magnets and precursors for creating 3d-4f mixed oxides. A series of 32 heterometallic ionic complexes  $[\text{CeNi}_6(\text{Ala})_{12}][(\text{Ln}_x\text{Ce}_{1-x})(\text{NO}_3)_3(\text{OH})_3(\text{H}_2\text{O})]$  ( $\text{Ln} = \text{Tb}, \text{Ho}, \text{Er}, \text{Tm}, \text{Yb}, \text{Lu}$ ) have been synthesized and characterized by XRD and ICP-MS [1]. The dependence of the degree of substitution of lanthanides in the anionic position on the nature of  $\text{Ln}^{3+}$  and precipitation conditions has been determined. The processes occurring during the formation of the complexes have been studied by UV-Vis, diffuse reflectance electronic spectroscopy, and ICP-MS. Based on these data, a model of equilibria in the system was proposed to explain the increase in the degree of substitution of Ln in the anionic position in the lanthanide series and with a decrease in the concentration of Ce and Ln in the solution from which precipitation is performed.

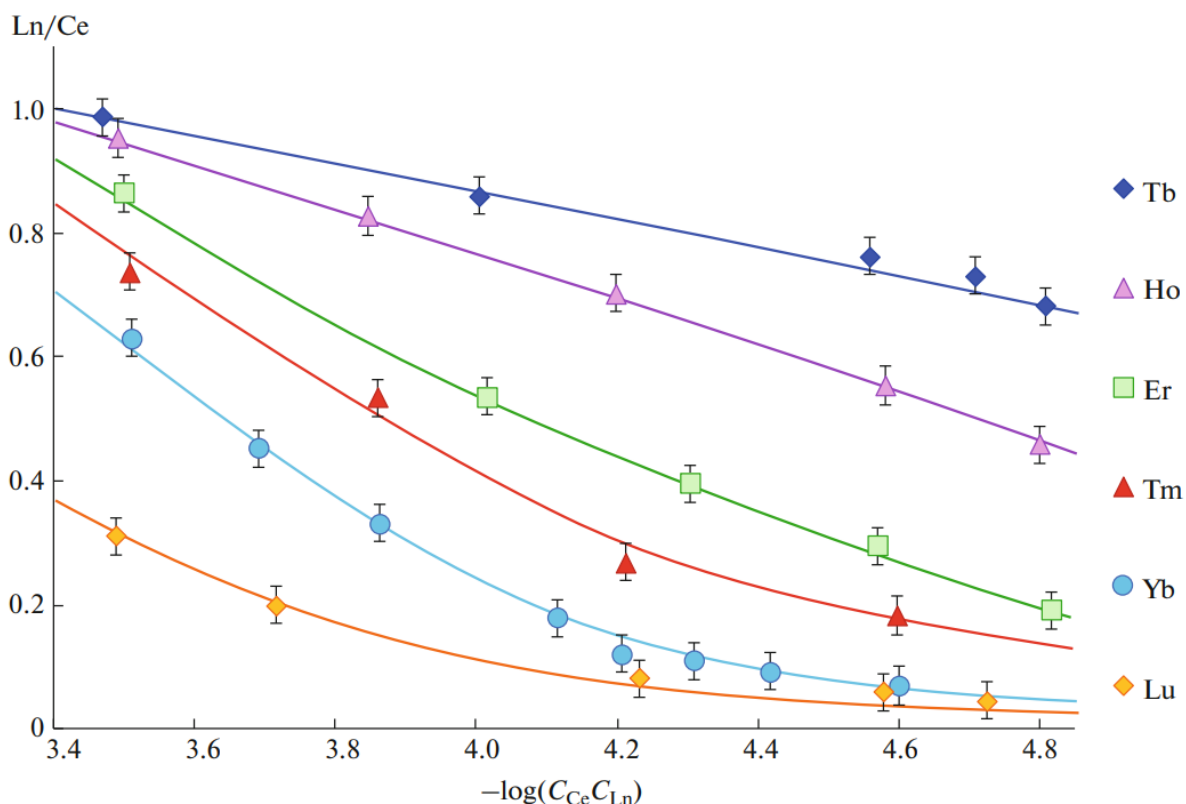

**Figure 1.** Dependence of the degree of substitution of  $\text{Ln}^{3+}$  in the anionic position on the nature of lanthanide and precipitation conditions.

**References**

[1] *Rus. J. of Inorg. Chem.* **2023**, 68, 1273

# ALL-INORGANIC SINGLE-ION MAGNET BASED ON HIGH-SPIN IRON (III) IN MAYENITE STRUCTURE

*Sharifullin T.Z.<sup>1</sup>, Kazin P.E.<sup>1</sup>, Vasiliev A.V.<sup>1</sup>*

<sup>1</sup> Lomonosov Moscow State University, Moscow, Russia

Student

[timsha.359@mail.ru](mailto:timsha.359@mail.ru)

Single molecule and single ion magnets (SMMs and SIMs, respectively) are atomic scale objects that show slow magnetization relaxation at low temperatures. Most modern SIMs are represented by metalorganic complexes of transition element ions and lanthanide ions with low coordination numbers providing strong axial anisotropy. Such molecular complexes are often unstable, so transition metal ions may be introduced into positions with crystal field anisotropy in crystal structure of inorganic solid forming magnetic centers with bistable ground states (inorganic SIMs or ISIMs) [1].

High-spin Fe<sup>3+</sup> free ion possesses a half-filled 3d-level without orbital momentum in its ground state. However slow relaxation of magnetization was observed in several compounds of iron(III) exhibiting low  $U_{eff}$  [2]. In addition, the reduced electron-phonon interaction of such electronic configuration may provide a longer spin coherence time required to create qubits for quantum computers [3].

In the present work imbedding of iron in an inorganic solid and possibility of forming the first Fe<sup>3+</sup> based ISIM are considered. Mayenite Ca<sub>12</sub>Al<sub>14</sub>O<sub>33</sub> was chosen as a crystalline host. It represents an anti-zeolite structure with positively charged cages partially filled with oxygen-based anions. Al atoms are found in two types of distorted tetrahedra of oxygen atoms (Al1 and Al2). Fe<sup>3+</sup> can partially substitute Al<sup>3+</sup> at the trigonally distorted tetrahedral site Al1 keeping its high-spin configuration. Such distortion may provide a crystal field anisotropy required to form a SIM unit [4].

Ceramic samples with nominal compositions Ca<sub>12</sub>Al<sub>14-x</sub>Fe<sub>x</sub>O<sub>33</sub>,  $x = 0, 0.05, \text{ and } 0.25$  (1, 2, and 3, respectively) were prepared via annealing of pellets in oxygen flow at 1400 °C. According to X-ray powder diffraction data samples represent cubic mayenite phase. The crystal structure was refined by Rietveld method. From 1 to 3 slight increasing of unit cell parameters is represented suggesting the replacement of a smaller Al<sup>3+</sup> by a large Fe<sup>3+</sup>.

According to dc magnetization measurements 2 and 3 show paramagnetic behavior down to 2 K. 1 also reveals weak paramagnetic response detectable at low temperatures. For the further analysis, magnetic response of 1 was subtracted from that of 2 and 3. It's worth noting, that paramagnetic behavior of 1 corresponds to that of a high-spin Fe<sup>3+</sup> with its content  $x=0.009$ .  $\chi^1(T)$  is fitted well with the Curie-Weiss equation, demonstrating  $\mu_{eff}$  of 5.64 and 5.73  $\mu_B$  and a very small  $\theta$  of 0.0 and -0.1 K for 2 and 3, respectively. These parameters also correspond to high-spin Fe<sup>3+</sup> ions diluted in a diamagnetic matrix with very small inter-ion interactions. For 2 and 3 temperature dependence of susceptibility-temperature product at 4 kOe and field dependence of magnetization at 2 K are in great agreement with model suggesting zero-field splitting axial parameter  $D = -0.67 \text{ cm}^{-1}$ .

Ac susceptibility measurements ( $\chi_{ac}$ ) under a dc magnetic field of 4 kOe reveal slow magnetization relaxation (SR) in all the samples. The undoped sample 1 also demonstrates similar SR. At low temperatures for 2 and 3, two maxima on  $\chi''(f)$  were observed corresponding to two relaxation processes. The lower frequency relaxation process (LSR) represents a minor fraction of slowly relaxing magnetic centers. The LSR fraction decreases with increasing temperature and disappears at 10 K. For the major SR process,  $\tau$  decreases fast with increasing Fe<sup>3+</sup> content. In 3 at temperatures above 5 K,  $\tau$  becomes too low to be estimated. For 1 and 2, relaxation time temperature dependences are obtained. For these samples practically the same values for  $U_{eff}$  are calculated. The refined  $U_{eff}$  is in good agreement with the energy gap  $6|D| = 4.2 \text{ cm}^{-1}$ , derived from the dc-magnetization data.

## References

- [1] *Chem. – Eur. J.* **2020**, *26*, 8834
- [2] *Chem. Commun.* **2019**, *55*, 13868
- [3] *Phys. Rev. Lett.* **2012**, *108*, 247213
- [4] *Inorg. Chem. Front.* **2024**, *11*, 2098

## Acknowledgements

This work was supported by the Russian Science Foundation (project № 21-13-00238).

# STRUCTURAL PECULIARITIES AND TRANSFORMATIONS OF THE METAL-ORGANIC FRAMEWORKS FAMILY BASED ON LANTHANIDE TEREPHTHALATES

*Shaulskaya M.D.<sup>1</sup>, Grebenyuk D.I.<sup>1</sup>, Voropaeva A.S.<sup>1</sup>, Tsybarenko D.M.<sup>1</sup>*

<sup>1</sup>Lomonosov Moscow State University, Moscow, Russia

Student

[shaulskaya.m@inbox.ru](mailto:shaulskaya.m@inbox.ru)

The study comprehensively investigated a new structural type of lanthanide-organic frameworks  $[(\text{CH}_3)_2\text{NH}_2]_2[\text{Ln}_2(\text{bdc})_4(\text{DMF})_2](\text{H}_2\text{O})_2$  called **LMSU-1** (Lomonosov Moscow State University). The existence of the **LMSU-1** structural type from La to Er has been established according to the low-temperature SCXRD experiment. The **Ln-LMSU-1** consists of binuclear centrosymmetric anionic structural blocks  $[\text{Ln}_2(\text{bdc})_4]^{2-}$ , connected by terephthalate linkers, the packaging voids contain guests such as water and dimethylformamide molecules, and dimethylammonium cations [1]. The lanthanide contraction has a noticeable impact on the linker structural function, leading to a division within the framework family into **La-type** ( $\text{CN}(\text{Ln}) = 9$ ) and **Dy-type** ( $\text{CN}(\text{Ln}) = 8$ ). To investigate structural stability of the **LMSU-1** family, we have performed a charge density analysis for all known **Ln-LMSU-1** according to Bader's "Atoms in Molecule" (AIM) theory.

Using VT-PXRD (Variable Temperature PXRD), we uncovered that even a subtle change in the structural function of the linker significantly influences the thermal behavior of the framework (Figure 1). For **La-type** frameworks, the elimination of guest molecules occurs in two successive isothermal stages, leading to the formation of stable intermediate forms. Conversely, the thermal behavior of **Dy-type** frameworks is entirely different, as the detachment of guest molecules is prolonged. For instance, for **Dy-LMSU-1**, the detachment process continues from 140 to 250°C. In addition, it was found that the greater the lanthanide compression, the lower the temperature at which large guest molecules are eliminated.

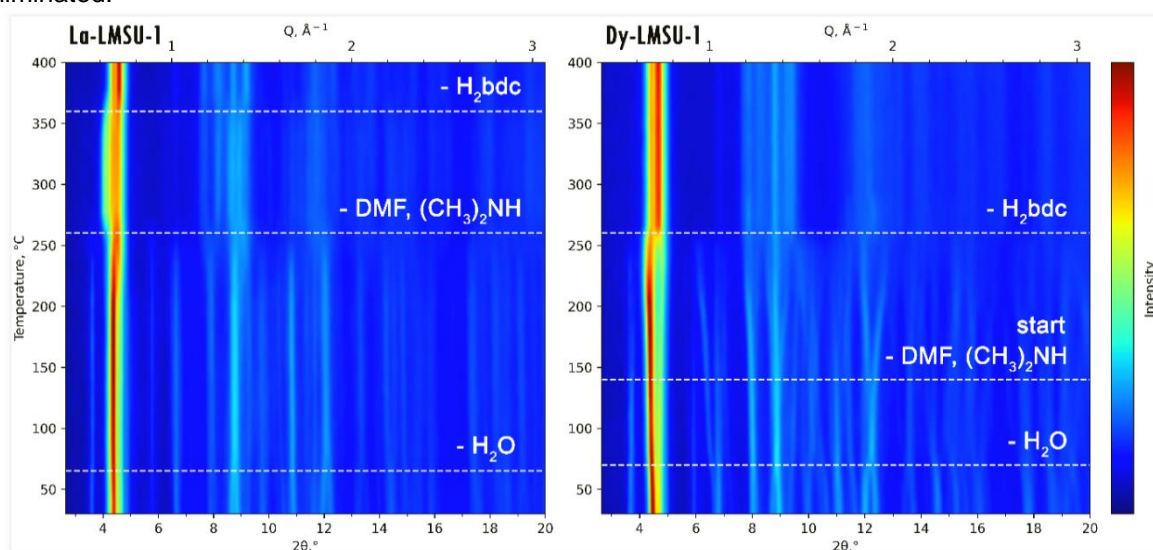

**Figure 1.** VT-PXRD patterns of **La-LMSU-1** (left picture) and **Dy-LMSU-1** (right picture) upon heating in capillary on air. Semi-transparent dashed lines divide the temperature range into several stages of the sample evolution (elimination of a water molecule, dimethylformamide and dimethylamine molecules, and a terminal terephthalic acid molecule),  $\lambda = 0.71073 \text{ \AA}$  (Mo K $\alpha$  radiation).

Furthermore, we researched the luminescent properties of the **Eu<sub>x</sub>Tb<sub>1-x</sub>-LMSU-1**. During the study, a remarkable change in the luminescence signal was observed as the framework underwent structural transformations upon heating, which could pave the way for using the luminescent signal in structural studies. Additionally, these frameworks show great potential for luminescent thermometry.

## References

[1] *ACS Omega* **2023**, 8 (50), 48394-48404

## Acknowledgements

This work was supported by the Russian Science Foundation (project No 22-73-10089).

# TENSIMETRIC STUDY OF I<sub>2</sub>-L SYSTEMS (L = PYRIDINE, PYRAZINE, 4,4'- BIPYRIDINE, 2-AMINOPYRIDINE)

*Shevchenko A.V.<sup>1</sup>, Doinikov D.A.<sup>1</sup>, Davydova E.I.<sup>1</sup>*

<sup>1</sup> St. Petersburg State University, St. Petersburg, Russia

Student

[st093562@spbu.ru](mailto:st093562@spbu.ru)

Molecular iodine forms  $\pi$ -donor-acceptor complexes with nitrogen-containing donors (L). The composition and structure of the complexes are determined by the donor nature and the synthesis conditions [1]. For instance, the reaction of ethanol solution of iodine with pyridine (py) in the 2:1 molar ratio leads to the formation of the ionic compound  $[I \cdot py_2]^+[I_3]^- \cdot 2I_2$  [2], whereas in the excess of ligand the molecular complex  $I_2 \cdot py$  is formed [3]. Pyrazine (pyz) forms with iodine the coordination polymer  $(I_2 \cdot pyz)_\infty$  synthesized by co-sublimation of equimolar quantities of reactants [4]. Recently in our laboratory the adduct  $2I_2 \cdot pyz$  was obtained by reaction of pyrazine with iodine in  $CH_2Cl_2$  solution. With stronger donor 4,4'-bipyridine (bipy) only  $2I_2 \cdot bipy$  [5] is formed both from solution and gaseous phase. Thermogravimetric studies of complexes show that the mass loss of  $(I_2 \cdot pyz)_\infty$  starts at the melting point of pyz (54-55 °C), whereas  $2I_2 \cdot bipy$  decomposes at much higher temperature (163 °C) with the evolution of gaseous iodine [5], but no thermodynamic data of the processes is specified.

In the present work the  $I_2$ -L (L = pyridine, 4,4'-bipyridine, pyrazine, 2-aminopyridine) systems were investigated using the static tensimetric method with membrane null-manometer [6]. This method allows to study both heterogeneous and homogeneous processes that involve gaseous phase. For reversible processes it is possible to estimate their equilibrium constants at different temperatures and their thermodynamical characteristics.

For the studied  $I_2$ -L systems it was shown that the ligand nature plays crucial role in their thermal behavior. It was found that in the  $I_2$ -py and  $I_2$ -bipy systems irreversible processes proceed at the elevated temperatures. We suggest that the result of them is the formation of iodinated ionic species. In the  $I_2$ -pyz system in the 1:1 molar ratio at the room temperature  $2I_2 \cdot pyz$  is formed. At 90°C it reacts with the excess of pyrazine to give polymeric  $(I_2 \cdot pyz)_\infty$  which further reversibly dissociates into gaseous components. With 2-apy we suggest the formation of the low volatile ionic complex due to the relatively low pressure measured in this system. For all reversible processes found in the systems we have estimated the values of  $\Delta_r H^\circ_T$  and  $\Delta_r S^\circ_T$  using the  $\ln K_{eq} = f(1/T)$  dependence.

## References

- [1] *J. Chem. Soc., Perkin Trans. 2* **1998**, 11, 2557
- [2] *Acta Chem. Scand.* **1961**, 15(2), 407
- [3] *Acta Cryst.* **2015**, E71, 463
- [4] *Acta Cryst.* **1992**, 48(12), 2259
- [5] *J. Chem. Soc. Perkin Trans. 2* **1997**, 12, 2773
- [6] *Russ. J. Gen. Chem.* **2019**, 89,1069

## Acknowledgements

This work was supported by the Russian Science Foundation (project No 23-13-00314).



# LUMINESCENT WATER SOLUBLE BLOCK COPOLYMERS OF CYCLOMETALATED PLATINUM (II) COMPLEXES AND POLYVINYLPIRROLIDONE: SYNTHESIS, STRUCTURE AND AGGREGATION INDUCED EMISSION EFFECT

*Shilov R.A.<sup>1</sup>, Shakirova J.R.<sup>1</sup>, Baigildin V.A.<sup>1</sup>*

<sup>1</sup> St. Petersburg State University, St. Petersburg, Russia  
Student  
[st075625@student.spbu.ru](mailto:st075625@student.spbu.ru)

Many platinum (II) complexes with pincer ligands are potentially applicable for the creation of highly effective sensors for bioimaging. However, in addition to adjusting the photophysical parameters of such compounds, an important task is to make the sensors water soluble and biocompatible, since bioimaging is impossible without those processes.

In this work, the approach of copolymerization of platinum complexes with a water soluble polymer (polyvinylpyrrolidone - pVP) was used. Thus, a vinyl group was introduced into the structure of the complex, and the group was then used to perform a polymerization reaction.

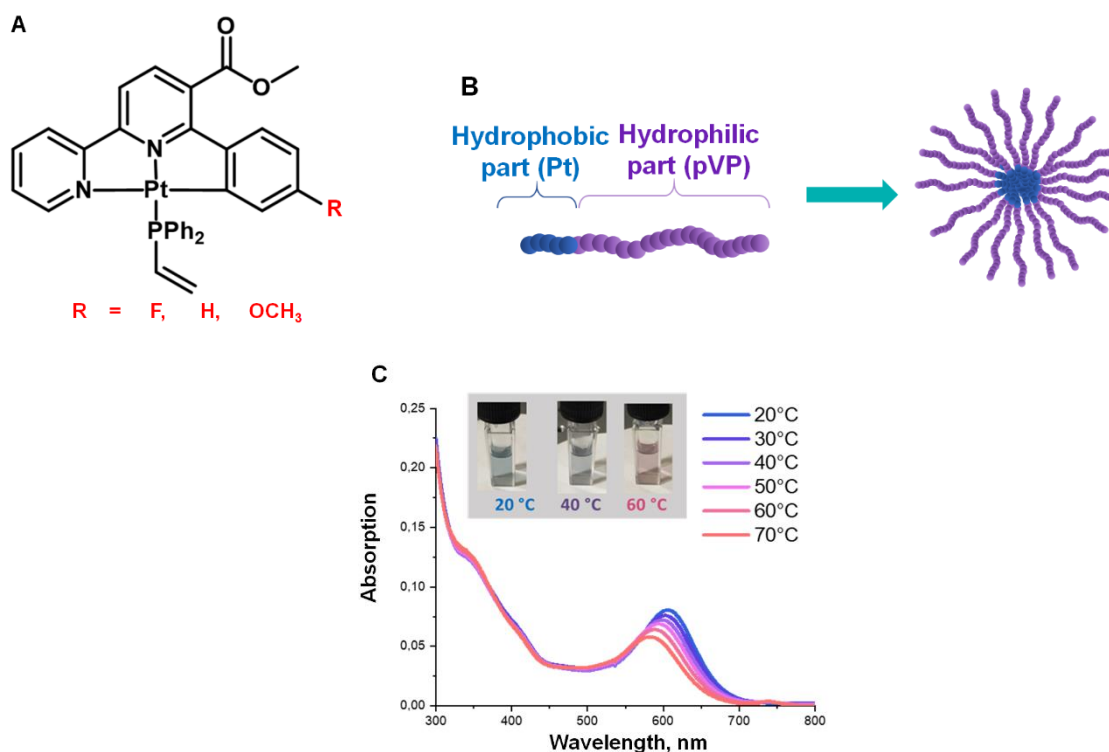

**Scheme 1.** **A.** Structure of the Pt (II) complexes. **B.** Illustration of the block copolymers aggregation. **C.** Temperature dependence of the copolymer's absorption spectra in 0,01 M NaCl solution (R = OCH<sub>3</sub>)

As a result, a series of products, which molecules are arranged as follows, was obtained. Those molecules consist of a hydrophobic block containing fragments of the Pt (II) complexes and a hydrophilic block containing polyvinylpyrrolidone. That structure leads to the ability of the obtained copolymers to form micelles in aqueous solutions, which leads to a change in the color of the solutions (i.e. the absorption spectra), depending on the solvent used, and on the concentration and temperature: a new absorption band at 600 nm appears as the solution is concentrated or cooled.

Also, it was found that aggregation shifts the emission of the compounds to the red and infrared region and increases the quantum yields of luminescence. This is a vivid example of the "Aggregation induced emission" effect.

## Acknowledgements

This work was supported by the Russian Science Foundation (project № 19-73-20055-П). The work was carried out using equipment of the Research Park of St. Petersburg State University (Centers for Magnetic Resonance, for Optical and Laser Materials Research, for Chemical Analysis and Materials Research, for X-ray Diffraction Studies, and Computing Center).

## DESIGN OF FERROELECTRIC METAL-ORGANIC FRAMEWORKS BY REPLACING SYMMETRIC LIGANDS WITH POLAR ONES

*Shmelev A.A.<sup>1</sup>, Shaikhutdinov I.K.<sup>1</sup>, Sokolov A.V.<sup>1</sup>, Alexandrov E.V.<sup>1</sup>*

<sup>1</sup>Samara State Medical University, Samara, Russia

PhD

[shmelsasha@yandex.ru](mailto:shmelsasha@yandex.ru)

Ferroelectrics induce spontaneous polarization in a crystal, capable of reorientation under the influence of external fields. More than 300 ferroelectrics are known, including inorganic materials, organic compounds, liquid crystals and polymers. Polar metal-organic coordination polymers (MOCPs) occupy a place between inorganic and organic materials [1,2]. As hybrid systems, they benefit from structural diversity and self-assembly capabilities from inorganic and structural blocks such as metal ions, ligands, clusters, templating molecules and solvents. The introduction of movable polar components that acquire mobility in an electric field, molecular rotors, makes it possible to configure reoriented electric polarization in the MOCP structure. We demonstrated the replacement of components in the crystalline structure of UiO-66 MOCP without disrupting its topological bond order. Thus, the terephthalate ligand was replaced with a 2,5-pyridinedicarboxylate ligand in various proportions. This complication and polarization of the framework leads to the development of a set of physical and chemical properties: the changing of adsorption activity (with the application of N<sub>2</sub>, CO<sub>2</sub>, metronidazole) and the emergence of a response to a constant and alternating electric field. Such a strategy of responsive vehicles design is promising for targeted drug delivery.

Furthermore, the structural diversity of potentially polar perovskite-like MOCPs from the Cambridge Structural Database has been analyzed.

### References

- [1] *Cryst. Eng. Comm.* **2022**. *24*, 2505
- [2] *Chem. Eur. J.* **2021**. *27*, 9180

### Acknowledgements

This work was supported by the Russian Science Foundation (project No 24-23-00162).

# OCTAHEDRAL HEXARHENIUM METHOXIDE CLUSTER COMPLEXES — NEW PRECURSORS FOR LIGAND EXCHANGE REACTIONS

*Sibiryakov M.S.*<sup>1,2</sup>, *Kashnik I.V.*<sup>2</sup>, *Brylev K.A.*<sup>2</sup>

<sup>1</sup> Novosibirsk State University, Novosibirsk, Russia

<sup>2</sup> Nikolaev Institute of Inorganic Chemistry SB RAS, Novosibirsk, Russia  
Student

[m.sibiryakov@g.nsu.ru](mailto:m.sibiryakov@g.nsu.ru)

Hexarhenium octahedral complexes with the cluster core  $\{\text{Re}_6\text{Q}_8\}^{2+/3+}$  (Q = S or Se) have attracted much attention during the last few decades. These compounds, which are phosphorescent in the red region of the spectrum, have potential applications in photodynamic therapy, in catalysis, and as components of various luminescent materials, bioimaging agents, and X-ray contrast agents. Their general formula is  $[\{\text{Re}_6\text{Q}_8\}\text{L}_6]^m$ , where L is the organic or inorganic external (apical) ligands. The cluster core is a relatively inert part of the complex, but the apical ligands can be substituted or modified during various chemical reactions. This feature allows not only to obtain new cluster compounds by ligand exchange reactions, but also to change their physicochemical properties, since the apical ligands significantly affect their luminescence properties.

To date, two precursors (and their modifications) were mainly used in ligand exchange reactions carried out in solutions: hexaacetonitrile  $[\{\text{Re}_6\text{Se}_8\}(\text{MeCN})_6]^{2+}$  [1] and hexahydroxo  $[\{\text{Re}_6\text{Q}_8\}(\text{OH})_6]^{4-}$  (Q = S or Se) [2,3] complexes. Despite their several advantages, they have synthetic limitations. For example, the hexaacetonitrile complex was obtained only for the  $\{\text{Re}_6\text{Se}_8\}^{2+}$  cluster core, and hexahydroxo ones are insoluble in classical organic solvents. Therefore, it seems to be an urgent task to obtain a precursor combining the positive aspects of these two compounds: the presence of labile apical ligands and solubility in organic solvents.

We found that the hexahydroxo complexes at room temperature slowly dissolve in methanol, and at the same time there is a substitution of  $\text{OH}^-$  ligands on  $\text{MeO}^-$ . A series of compounds  $[\{\text{Re}_6\text{Q}_8\}(\text{MeOH})_n(\text{MeO})_{6-n}]^{n-4}$  ( $n = 0, 2, 4, \text{ or } 6$  for Q = S;  $n = 0$  or 4 for Q = Se) were obtained. We also demonstrated that heating a methanol solution of  $[\{\text{Re}_6\text{Q}_8\}(\text{MeO})_6]^{4-}$  with  $\text{PPh}_3$  produced *cis*- and *trans*-isomers of the four-substituted forms of  $[\{\text{Re}_6\text{Q}_8\}(\text{PPh}_3)_4(\text{MeO})_2]$ . By further modification of the ligand environment of *trans*- $[\{\text{Re}_6\text{Q}_8\}(\text{PPh}_3)_4(\text{MeO})_2]$ , complexes of *trans*- $[\{\text{Re}_6\text{Q}_8\}(\text{PPh}_3)_4(\text{MeOH})_2]^{2+}$  and *trans*- $[\{\text{Re}_6\text{Se}_8\}(\text{PPh}_3)_4(\text{CF}_3\text{COO})_2]$  were obtained, which is the first example of a hexarhenium cluster complex with perfluorinated carboxylate apical ligand.

As a result of this work, 12 new hexarhenium cluster complexes were obtained, 11 of which were characterized by single crystal X-ray diffraction. Luminescence spectra were recorded for the compounds and quantum yields were determined. The possibility of  $\text{MeO}$ -ligand substitution was demonstrated, which makes it possible to use the methoxy complexes as precursors for solution reactions of ligand exchange in organic solvents.

## References

- [1] *Inorg. Chem.*, **1997**, 119, 2163.
- [2] *Inorg. Chem.*, **2007**, 47, 7414.
- [3] *Inorg. Chem.*, **2019**, 58, 15889.

## Acknowledgements

This work was supported by the Russian Science Foundation (project No 19-73-20196-P).

# EMITTERS BASED ON IRIIDIUM(III) COMPLEXES WITH C,N-CHELATE ACYCLIC DIAMINOCARBENE LIGANDS

*Skripnyak P.O.<sup>1</sup>, Luzianin K. V.<sup>2</sup>, Kinzhalov M. A.<sup>1</sup>*

<sup>1</sup>St. Petersburg State University, St. Petersburg, Russia

<sup>2</sup>University of Liverpool, Liverpool, United Kingdom

Student

[st095077@student.spbu.ru](mailto:st095077@student.spbu.ru)

Iridium cyclometalated complexes have received considerable attention in recent years owing to favourable photophysical properties such as good stability, high photoluminescence quantum yields, short triplet state lifetimes, and the ability to participate in outer sphere electron-transfer reactions [1, 2]. These complexes have been successfully applied for oxygen sensing, biological labelling, photosensitization, and emissive materials in electrochemiluminescent and organic light emitting diodes.

In this work, we report a detailed study of the cyclometalated iridium(III) complexes supported by acyclic diaminocarbene (ADC) ancillary ligands, which display phosphorescence in the green spectral region. A panel of new Ir<sup>III</sup>-ADC complexes was prepared *via* the metal-mediated coupling of various arylisocyanides with aminoheterocycles. Our investigation revealed that substituent changes on the aryl in the ADC ancillary ligand can affect emission quantum yields and excited state lifetimes without any significant changes of the emission energy and spectral profiles. It is suggested that the ancillary ligand has minimal orbital contribution to the lowest emitting excited state but can influence the excited state dynamics. Analysis of frontier molecular orbital character, energy gaps, and UV/vis spectra by density functional theory (DFT) and time-dependent DFT (TD-DFT) approaches provide insights into the character of these processes. In addition, the obtained results show that the phosphorescence quantum yields and the triplet state lifetimes are substantially higher in the PMMA film and in the solid state than those in solution. These observations are a manifestation of substantially reduced nonradiative decay rates in solid state and in polymeric matrix. A series of OLEDs have been fabricated using these phosphors that paves the avenue for further exploration of cyclometalated complexes bearing acyclic diaminocarbene ancillary ligands as efficient emitting components of OLED devices.

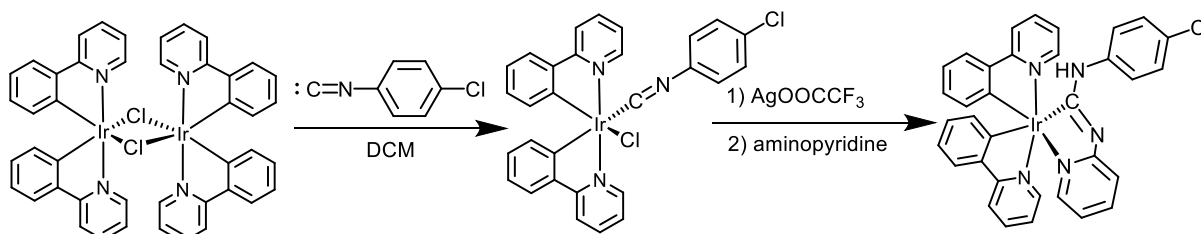

**Scheme 1.** Synthesis of Ir cyclometalated complexes with aminopyridine

## References

- [1] *Inorg. Chem. Front.*, 2022, 9(3), 417-439  
[2] *Inorg. Chem.*, 2020, 59(4), 2209-2222

## Acknowledgements

This work was supported by a grant from the Ministry of Science and Higher Education of the Russian Federation for large-scale research projects in high priority areas of scientific and technological development (grant number 075-15-2024-553). Measurements were performed at Center for Magnetic Resonance, Center for X-ray Diffraction Studies, Center for Chemical Analysis and Materials Research, and Computing Centre (all belong to St Petersburg University).

# IODONIUM OCTAMOLYBDATE: NEW EDGE IN CHEMISTRY OF IODONIUM METALLATE

*Natalia S. Soldatova,<sup>1</sup> Daniil M. Ivanov,<sup>2</sup> Pavel A. Abramov,<sup>1,3</sup> Pavel S. Postnikov<sup>1</sup>*

<sup>1</sup>Tomsk Polytechnic University, Tomsk, Russia

<sup>2</sup>St. Petersburg State University, St. Petersburg, Russia

<sup>3</sup>Nikolaev Institute of Inorganic Chemistry SB RAS, Novosibirsk, Russian Federation

Young scientist

[SoldatovaNS@tpu.ru](mailto:SoldatovaNS@tpu.ru)

Iodonium polyoxometalates are relatively new types of compounds, but already find application in polymer chemistry and synthesis of new material. [1,2] Previously structure of idonium polyoxometalates was poorly studied and do not include analysis of noncovalent interaction. Analysis of halogen bonding between idonium cations and polyoxometalate anions are essential for follow application in chemical engineering.

In this work, we prepared several examples of idonium beta-octamolybdate and study of their crystalline structure. We found that idonium cation preferably interact with lacune of octamolybdate anion with the formation of tetrahedral pyramidal assembly. Analysis of halogen bonding show that this assembly is the result of a combination of three types of halogen bonding: regular two-centered XB and bifurcated XB that in agreeing with the IUPAC definition of XB, and unconventional "orthogonal" XB. The "orthogonal" XB is not related to interaction with  $\sigma^*(C-I)$  orbital and determined only by the geometry of molecules. Nevertheless, similar interactions can be found in large numbers of idonium salts.

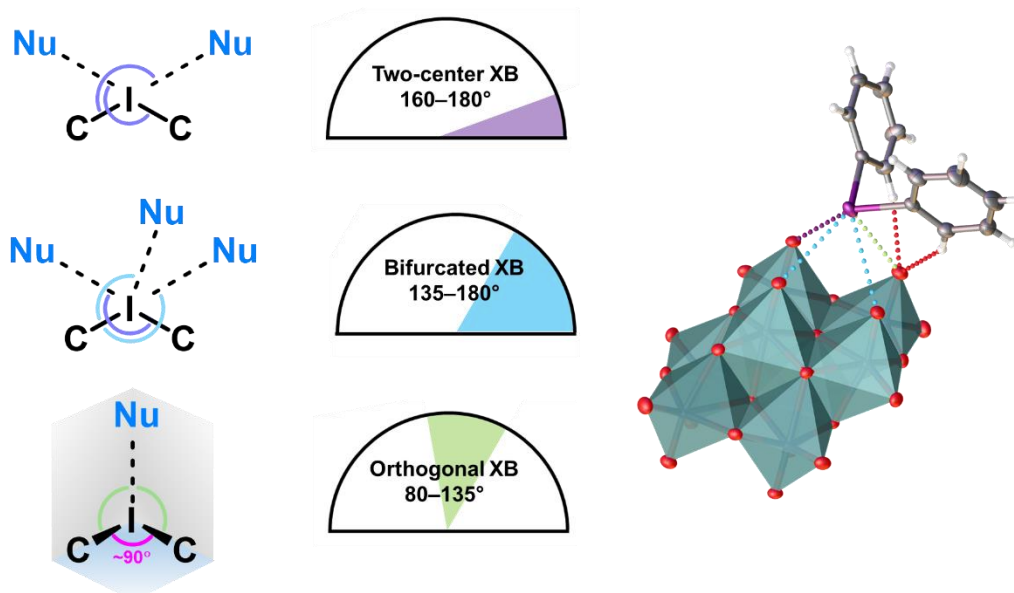

**Scheme 1.** Classification of halogen bonding in idonium beta-octamolybdate.

## References

- [1] *Eur. Polym. J.*, 2023, 195, 112193.  
[2] *J. Clust. Sci.*, 2022, **33**, 2375–2381

## Acknowledgements

This work was supported by the Russian Science Foundation (project No 23-73-10091).

## HALOGEN BONDING IN DIPHENYLIODONIUM DICHROMATE

*Stozharova M.A.*<sup>1</sup>, *Eliseeva A.A.*<sup>1</sup>, *Ivanov D.M.*<sup>1</sup>, *Soldatova N.S.*<sup>2</sup>

<sup>1</sup> St. Petersburg State University, St. Petersburg, Russia

<sup>2</sup> Tomsk Polytechnic University, Tomsk, Russia

Bachelor student

[st116585@student.spbu.ru](mailto:st116585@student.spbu.ru)

Halogen bonding (XB) — together with other types of noncovalent interactions — has exponentially emerged as an important concept in polymer science, supramolecular design, and crystal engineering. Modern XB-based crystal engineering mainly utilizes monovalent halogen organic compounds, exhibiting one  $\sigma$ -hole per one halogen(I) site. In the vast majority of cases, these atoms form two-center XBs. A suitable alternative to the polyhalogenated compounds is a diaryliodonium salt bearing I(III) site as a double  $\sigma$ -hole donor. A suitable XB-accepting synthon for these species should provide a number of nucleophilic sites. In this work, we chose the dichromate anion as such XB-accepting building block.

Complex  $[\text{Ph}_2\text{I}]_2[\text{Cr}_2\text{O}_7]$  (Ph =  $\text{C}_6\text{H}_5$ ) was obtained by ion exchange reaction between water solutions of potassium dichromate and diphenyliodonium triflate. Single crystals of the complex suitable for X-ray diffraction (XRD) were released from the water by slow evaporation of the solvent at room temperature in air. Inspection of the XRD data of the obtained crystals revealed the presence of interionic  $\text{C}-\text{I}\cdots\text{O}$  XBs between iodine atoms of the cations and nucleophilic oxygen atoms of  $[\text{Cr}_2\text{O}_7]^{2-}$  anion, where the latter acts as XB-accepting synthon forming XBs by two O-centers (Fig. 1a). The distances between the iodine and oxygen atoms are shorter than the appropriate sum of the van der Waals radii, and the angles  $\angle(\text{C}-\text{I}\cdots\text{O})$  around I centers fulfill to the IUPAC criteria for XBs. Other noncovalent interactions are presented by  $\text{C}-\text{I}\cdots\text{C}$  XBs between the iodine centers and  $\text{C}^{\text{Ar}}$  atoms of the cations. The observed contacts together form 2D chains in the crystal structure of  $[\text{Ph}_2\text{I}]_2[\text{Cr}_2\text{O}_7]$  (Fig. 1b).

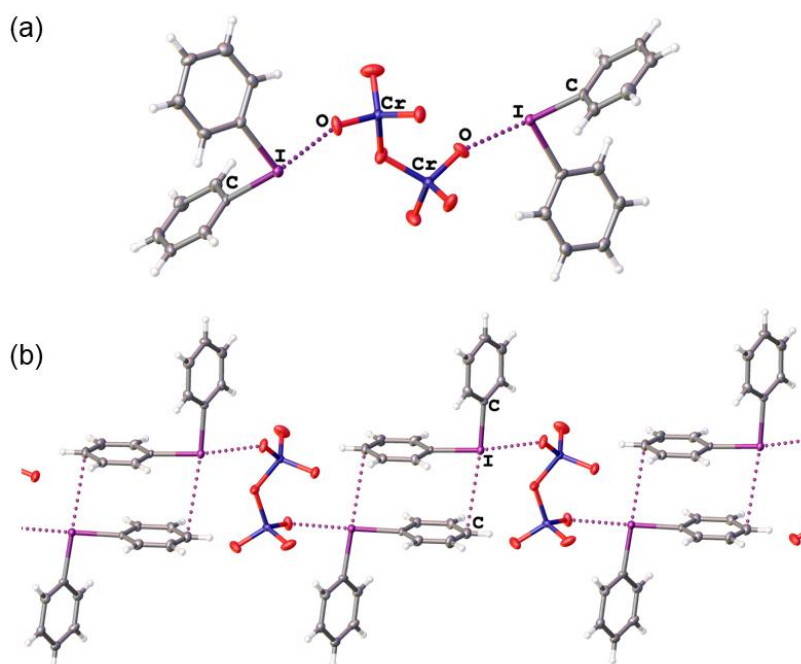

**Figure 1.** The  $\text{C}-\text{I}\cdots\text{O}$  XBs (a) and 2D chains (b) in the crystal structure of  $[\text{Ph}_2\text{I}]_2[\text{Cr}_2\text{O}_7]$ . The XBs are given by dotted lines and thermal ellipsoids are shown with the 50% probability.

We examined the geometric and energetic features of the detected contacts using the combined experimental and theoretical approaches. The noncovalent nature of the interactions was confirmed theoretically by the DFT calculations via several computational tools (QTAIM, DFT energies, NCI and EDD plots, MEP surfaces, ELF analysis). In this work, we found the first example of the XB that involves oxygen atoms of the dichromate anion acting as XB acceptor toward iodine(III) centers of the diphenyliodonium cations behave as  $\sigma$ -hole donors.

## HIGH-TEMPERATURE ORGANOMETALLIC SYNTHESIS OF LUMINESCENT CERIUM (IV) OXIDE NANOPARTICLES

*P.D. Strokin<sup>1</sup>, E.A Goryacheva<sup>1</sup>, O.A Goryacheva<sup>1</sup>, N.R. Popova<sup>2</sup>, I.Yu. Goryacheva<sup>1</sup>.*

<sup>1</sup> Saratov State University, Saratov, Russia

<sup>2</sup>Institute of Theoretical and Experimental Biophysics, Pushchino, Russia

Student

[stropa99@mail.ru](mailto:stropa99@mail.ru)

Fluorescent nanoparticles based on oxides of rare earth elements have low toxicity, and their surface is easily functionalized, which opens up prospects for the use of such structures in optics, energy and bioanalysis [1]. Nanoscale cerium dioxide is a well—researched system for various applications, but the luminescent properties of these particles have not been practically studied [2]. At the moment, many approaches to the production of cerium nanoparticles have been described, but for the most part they are complex, lengthy and time-consuming. High-temperature organometallic synthesis is a suitable alternative for the production of high-quality CeO<sub>2</sub> nanoparticles [3]. The use of rare earth elements such as samarium opens up prospects for the use of the resulting nanoparticles in MRI [4]. However, the methods of doping cerium nanoparticles obtained by the high-temperature method are currently practically not described.

The obtained images also allow us to confirm the dependence of the shape of the obtained nanocrystals on the synthesis conditions. With a ratio of calcium acetate: oleic acid of 1:2, we obtained nanoplates, and with a ratio of 1:4, nanorods (Scheme 1).

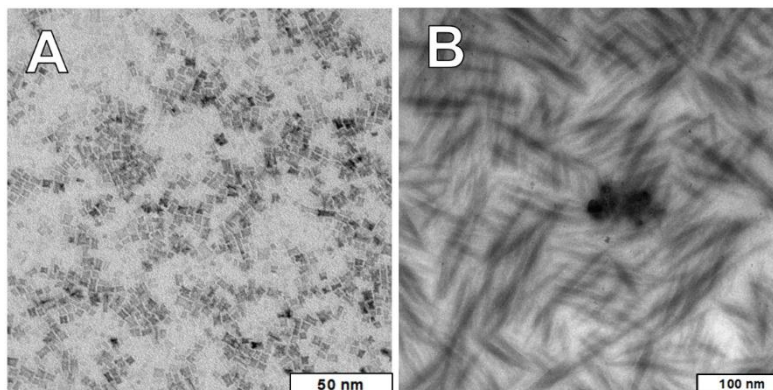

**Scheme 1.** TEM images of the obtained cerium oxide NPs: nanoplates (A) and nanorods (B)

The synthesized cerium nanoparticles have a maximum emission wavelength of approximately 500 nm, a photoluminescence quantum yield of 6% on average, a size of 4 nm, a hydrodynamic diameter of 35 nm, and a period of colloidal stability in nonpolar solvents of over 6 months. The low size dispersion of synthesized nanocrystals reveals the advantage of high-temperature organometallic synthesis. It is noted that the size of the obtained nanoparticles increases with an increase in the amount of added cerium precursor (while maintaining the amount of stabilizer). After purification of the obtained nanostructures, a decrease in the quantum yield of photoluminescence is noted.

### References

- [1] Brunner T. J. et al. In vitro cytotoxicity of oxide nanoparticles: comparison to asbestos, silica, and the effect of particle solubility //Environmental science & technology. – 2006. – T. 40. – №. 14. – C. 4374-4381.
- [2] Krishnan A. et al. One-pot synthesis of ultra-small cerium oxide nanodots exhibiting multi-colored fluorescence //Journal of colloid and interface science. – 2013. – T. 389. – №. 1. – C. 16-22.
- [3] Lin H. L., Wu C. Y., Chiang R. K. Facile synthesis of CeO<sub>2</sub> nanoplates and nanorods by [1 0 0] oriented growth //Journal of colloid and interface science. – 2010. – T. 341. – №. 1. – C. 12-17.
- [4] Eriksson P. et al. Cerium oxide nanoparticles with antioxidant capabilities and gadolinium integration for MRI contrast enhancement //Scientific reports. – 2018. – T. 8. – №. 1. – C. 6999.

### Acknowledgements

This work was supported by the Russian Science Foundation (project No 22–63–00082).

# POLYNUCLEAR TRANSITION METAL COMPLEXES BASED ON SUBSTITUTED HYDROBENZAMIDES

*Strunin D.D.,<sup>1,2</sup> Nikovsky I.A.,<sup>2</sup> Nelyubina Yu.V.<sup>2</sup>*

<sup>1</sup>Lomonosov Moscow State University, Chemistry Department, Moscow, Russia

<sup>2</sup>A.N. Nesmeyanov Institute of Organoelement Compounds of the Russian Academy of Sciences, Moscow, Russia

Student, 4th year of specialty

E-mail: [strunin02@yandex.ru](mailto:strunin02@yandex.ru)

The development of molecular systems capable of intramolecular electron transfer is a key idea of advanced concepts for the creation of ultra-dense information storage devices, molecular switches and other materials [1]. An example of such systems are transition metal complexes (including polynuclear ones) containing at least two redox centres that are connected by a bridge, which makes it possible to transfer the electron of the ligand to the metal. Such complexes are capable of exhibiting the properties of a molecular magnet, ferromagnetic/antiferromagnetic interactions [2]. Due to a possible spin transition, they can be used as molecular switches in the case of using 3d<sup>4</sup>-3d<sup>7</sup> metals ions. Such spin crossover will create several magnetic states in this system, between which it will be possible to switch [3].

In our work, a hydrobenzamide ligand (**L**) of the N<sub>2</sub>O<sub>3</sub> type was synthesized, capable of binding two transition metal ions (for example, Mn<sup>3+</sup> scheme 1), forming binuclear complexes with the implementation of propeller geometry (Scheme 1).

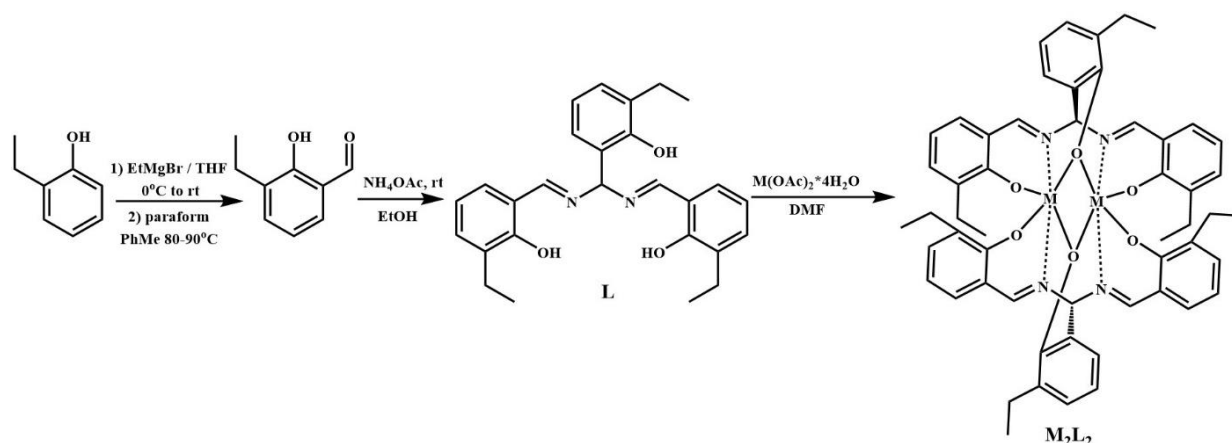

**Scheme 1.** Synthesis of a binuclear complex M<sub>2</sub>L<sub>2</sub>.

The obtained binuclear complexes were characterized by X-ray diffraction analysis, cyclic voltammetry and magnetometry. For the manganese complexes, the structure of the obtained crystals includes not only molecules of the Mn<sub>2</sub>L<sub>2</sub>, but also a cluster of manganese acetate (Mn<sub>6</sub>(μ-O)<sub>2</sub>(OAc)<sub>10</sub>(DMF)<sub>4</sub>) in a ratio of 2:1, which makes it possible to regulate the magnetic properties of the resulting crystalline material. A similar approach can be transferred on the complexes of related geometry.

## References

- [1] *Coord. Chem. Rev.* **2017**, *346*, 176–205.
- [2] *Coord. Chem. Rev.* **2014**, *268*, 23–40.
- [3] *Coord. Chem. Rev.* **2020**, *414*, 213–240.

## Acknowledgements

This research was supported by the Russian Science Foundation and Deutsche Forschungsgemeinschaft, a joint RSF-DFG project 22-43-04437.



SYNTHESIS AND CATALYTIC PROPERTIES OF CATIONIC PALLADIUM- AND NICKEL-  
ACETYLACETONATE COMPLEXES BEARING PYRIDINYLMINE LIGANDS

*Suchkova A.V.<sup>1</sup>, Bykov M.V.<sup>1</sup>, Pakhomova M.V.<sup>1</sup>, Suslov D.S.<sup>1</sup>*

<sup>1</sup> Irkutsk State University, Irkutsk, Russia

Junior researcher

[nasyaya27@gmail.com](mailto:nasyaya27@gmail.com)

Among metal-based catalysts, complexes with Schiff base ligands belong to a very important group because of their multifunctionality and versatility. Particular attention has been directed toward nitrogen-donor late transition metal complexes as a result of Brookhart's report on Pd(II) and Ni(II) diimine catalyst systems [1,2] for polymerization of olefins. Later, the discovery, made by Brookhart and Gibson, that iron and cobalt complexes bearing bis(imino) pyridine ligands are also effective catalyst for converting olefins to high molecular weight polymers [3–5] led to the development of a number of nitrogen-donor ligands belonging to the family of iminopyridines.

This report presents the results of the synthesis of new cationic acetylacetonate palladium and nickel complexes bearing pyridinylimine ligands. Palladium(II) complexes of the form [Pd(acac)(N<sup>^</sup>N<sup>^</sup>)]BF<sub>4</sub> were synthesized via nitrile displacement in [Pd(acac)(MeCN)<sub>2</sub>]BF<sub>4</sub> by the bidentate ligands L of type 2-C<sub>5</sub>H<sub>4</sub>N-CH=N-(CH<sub>2</sub>)<sub>n</sub>OMe or 2-C<sub>5</sub>H<sub>4</sub>N-CH=N-Ar, as depicted in Scheme 1. Nickel(II) complexes of the form [Ni(acac)(N<sup>^</sup>N<sup>^</sup>)]CF<sub>3</sub>SO<sub>3</sub> were synthesized by reacting waterless nickel acetylacetonate with trifluoromethanesulfonic acid in the presence of the bidentate iminopyridine ligands L, as depicted in Scheme 1.

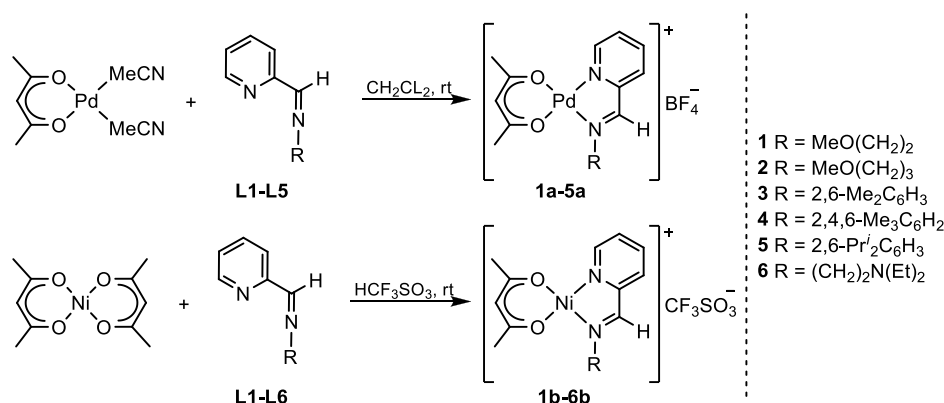

**Scheme 1.** Synthesis of acetylacetonate palladium (**1a-5a**) and nickel (**1b-6b**) complexes bearing pyridinylimine ligands (**L1-L6**).

The structures of palladium complexes were analyzed by X-ray crystallography, IR, NMR, DFT, ESI-MS, and elemental analysis. NMR spectroscopic studies showed that the chemical shift  $\delta$  values in <sup>1</sup>H and <sup>13</sup>C NMR spectra of complexes **1a-5a** are consistent with NMR data for the ligands presented in the literature. IR spectroscopic data proved the coordination of the imine and pyridine fragments of the corresponding ligands to the palladium atom. X-ray crystallography data for single crystals for **3a** and **5a** confirmed the formation of four-coordinate palladium(II) centre with a non-coordinating [BF<sub>4</sub>]<sup>-</sup> anion. The overall geometry around Pd in the complexes is approximately square planar. The complexes **1a-5a** catalyze hydroamination of phenylacetylene with aniline to give the Markovnikov imine product as well as polymerization of norbornene. In addition, the report contains the results of the synthesis of cationic nickel complexes and the results of their catalytic tests.

### References

- [1] *Journal of the American Chemical Society*. **1995**, *117*, 6414.
- [2] *Chemical Reviews*. **2000**, *100*, 1169.
- [3] *Chemical Reviews*. **2003**, *103*, 283.
- [4] *Chemistry—A European Journal*. **2000**, *6*, 2221.
- [5] *Chemical Reviews*. **2007**, *107*, 1745.

### Acknowledgements

This work was supported by the Government Assignment for Scientific Research from the Ministry of Science and Higher Education of the Russian Federation (FZZE-2023-0006).

# A SOLVENT-FREE SYNTHESIS OF COBALT-CONTAINING CATALYSTS FOR THE HYDROLYSIS OF SODIUM BOROHYDRIDE

*Sukhorukov D.A., Dmitruk K.A., Mukha S.A., Komova O.V., Simagina V.I., Netskina O.V.*

Boreskov Institute of Catalysis SB RAS, Novosibirsk, Russia

PhD student

[sukhorukov@catalysis.ru](mailto:sukhorukov@catalysis.ru)

Nowadays there is a necessity to create advanced technologies for compact hydrogen storage in portable energy devices based on fuel cells. Taking into account a high hydrogen capacity, a chemically-bonded form of hydrogen such as sodium borohydride is of primary interest [1]. Water addition to this hydride immediately leads to the H<sub>2</sub> generation according to the following reaction:

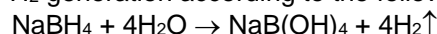

In the presence of catalysts this process can be carried out even at negative ambient temperatures, making the hydride interesting for H<sub>2</sub> production in Russian different climatic conditions. Among other catalysts, a specific attention is paid towards systems with Co<sub>3</sub>O<sub>4</sub>, as they possess high activity and stability in the hydrolysis of NaBH<sub>4</sub> [2]. Recently, we have noted [3] that the synthesis method influences the catalytic properties of cobalt oxide. Developing this tendency and taking into account the principles of Green Chemistry, we propose a new approach based on a solvent-free synthesis of cobalt catalysts by a solid-state combustion (SSC) of cobalt-organic complexes. The complex compounds contained energy-rich N-containing ligands (imidazole, pyrazole, and ethylenediamine) and nitrate- or perchlorate-anions as oxidizers. The formation of the complexes under study was confirmed by ATR-FTIR, XRD, etc.

The synthesized cobalt complexes were heated in the air above the critical temperature of the thermal explosion to initiate their gasification with the formation of highly-dispersed condensed phase, i.e. cobalt oxide particles [4]. The mechanism of SSC was described by thermal analysis.

The obtained samples were tested in the hydrolysis of NaBH<sub>4</sub>, the kinetics of the process was investigated with temperatures range of 20-60 °C. It was shown that initially there was an induction period with slow hydrogen generation. At this stage there was a cobalt reduction with the formation of active catalyst phase. The duration of this stage was defined by the cobalt state, depending on the gasification conditions and the composition of the initial complex. After the activation, the rate of hydrogen evolution sharply rose, and the kinetics of the reaction was described by the zero order equation. At the same time the calculated values of activation energy were similar for all samples tested, in spite of the different rate of H<sub>2</sub> generation (Fig. 1). It should be noted that all of the catalysts, synthesized by SSC, were characterized by a higher activity, compared to the commercial Co<sub>3</sub>O<sub>4</sub>.

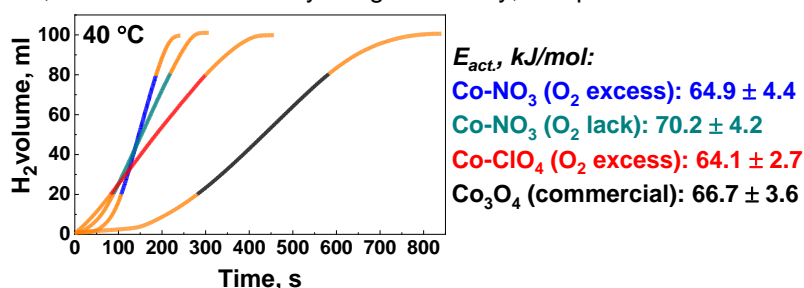

**Figure 1.** H<sub>2</sub> evolution rate per time at 40 °C for catalysts under study

Thus, we have demonstrated the perspective of this approach to the synthesis of Co-containing catalysts from energy-rich complexes to obtain hydrogen by the catalytic hydrolysis of NaBH<sub>4</sub>.

## References

- [1] *Int. J. Hydrogen Energy*. **2021**, 46, 726–765
- [2] *Appl. Catal. A Gen.* **2016**, 515, 1–9
- [3] *Catal. Today*. **2015**, 242, 221–229
- [4] *Nanomaterials*. **2021**, 11, 12, 3332

## Acknowledgements

The authors are deeply grateful to Bulavchenko O.A., Prosvirin I.P., Pochtar A.A., Shmakov A.G., Paletsky A.A. for the comprehensive assistance in this research. This work was supported by the Ministry of Science and Higher Education of the Russian Federation within the framework of the state assignment of the Boreskov Institute of Catalysis SB RAS (the project FWUR-2024-0034).

MANGANESE(II) COMPLEXES BASED ON PHOSPHINATAMIDES: SYNTHESIS, STRUCTURE, PHOTOLUMINESCENT PROPERTIES

*Taigina M. D.*<sup>1,2</sup>, *T.S. Sukhikh*<sup>2</sup>, *A.S. Berezin*<sup>2</sup>, *Nafikov*<sup>1,2</sup> *M.D.*, *Vinogradova K.A.*<sup>2</sup>

<sup>1</sup> Novosibirsk State University, Novosibirsk, Russia

<sup>2</sup> Nikolaev Institute of Inorganic Chemistry, Novosibirsk, Russia

Student

m.taigina@g.nsu.ru

Photo- and electroluminescent coordination compounds based on *d*-metals have been intensively studied in the recent years due to their application in OLED devices. The luminescence of Mn(II) compounds is sensitized by antenna ligands, and emission occurs from <sup>4</sup>T<sub>1</sub>→<sup>6</sup>A<sub>1</sub>. Phosphine oxides (P=O ligands) can be a promising class of such antennas for synthesis of highly luminescent Mn(II) compounds. Mn(II) complexes with P=O ligands usually show PL and can be alternative to common Ir(III)-based emitters. There is quite simple method for synthesis of polydentate P=O ligands, it is a reaction between amino derivatives R-NH<sub>2</sub> (R is a nitrogen-containing heterocycle) with P(Ph)<sub>2</sub>Cl under mild conditions and an oxidation reaction; compounds L<sup>1</sup>, L<sup>2</sup> and L<sup>3</sup> were prepared by this method (see scheme 1). Despite the fact that the synthesis is quite simple, only Cu<sup>2+</sup> and Co<sup>2+</sup> complexes with L<sup>2</sup> have been published, complexes based on L<sup>1</sup> and L<sup>3</sup> are unknown.

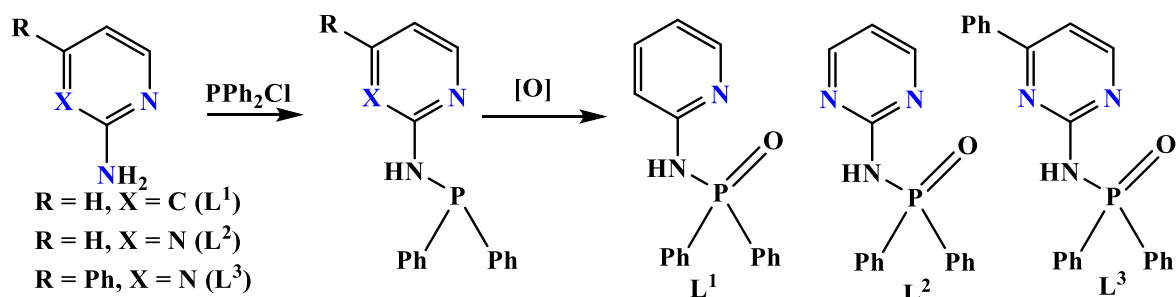

The aim of the current work is to synthesize manganese(II) complexes based on L<sup>1</sup>, L<sup>2</sup> and L<sup>3</sup> and to study the influence of different anions on structure formation and PL properties. Five new coordination compounds have been synthesized by a reaction of MnX<sub>2</sub>·4H<sub>2</sub>O (X = Cl, Br, Sal – salicylate-ion) and L<sup>n</sup> in organic solutions. The manganese(II) bromide complex with L<sup>2</sup>, manganese(II) chloride complex with L<sup>2</sup>, and manganese(II) salicylate complex with L<sup>1</sup> were structurally characterized by X-ray single crystal diffraction. The coordination polyhedron around the Mn atoms can be described as a strongly distorted octahedron. The ligands L<sup>1</sup> - L<sup>3</sup> are both ambidentally and bidentally coordinated to the manganese atoms by N atoms of a heterocycle and O atom of the P=O group. According to X-ray single crystal data, the manganese(II) chloride complex with L<sup>3</sup> has a polymeric structure. The manganese(II) bromide complex has a tetranuclear structure and the manganese(II) salicylate complex has a trinuclear structure.

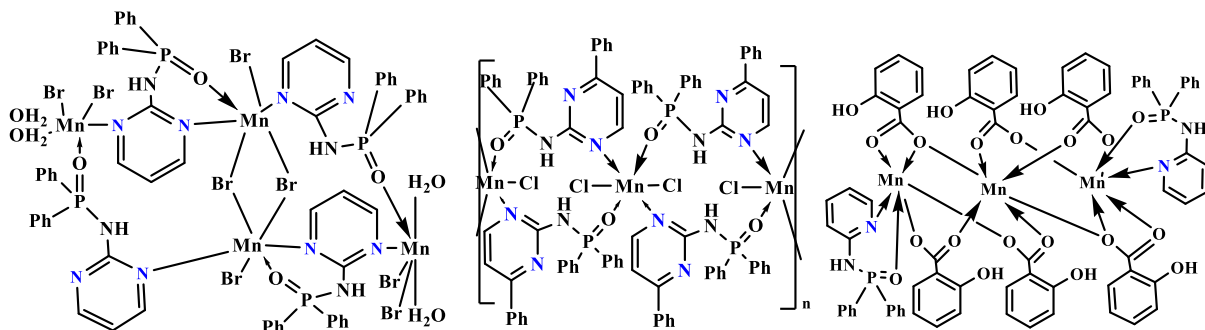

Fig.1. From left to right [Mn<sub>4</sub>Br<sub>8</sub>(H<sub>2</sub>O)<sub>4</sub>(L<sup>2</sup>)<sub>4</sub>]·EtOH·H<sub>2</sub>O, [Mn(L<sup>3</sup>)<sub>2</sub>Cl]<sub>n</sub>, [Mn<sub>3</sub>(L<sup>1</sup>)<sub>2</sub>(Sal)<sub>6</sub>]·MeCN.

The complex [Mn(L<sup>3</sup>)<sub>2</sub>Cl]<sub>n</sub> exhibits strong red phosphorescence in the solid state with a quantum yield of 15%. The PL properties of other complexes are being investigated.

# DEVELOPMENT OF APPROACHES TOWARDS ENHANCEMENT OF VISIBLE LIGHT-ABSORPTION IN CYCLOMETALATED IRIIDIUM(III) COMPLEXES

*Tatarin S.V.*<sup>1</sup>, *Meshcheriakova E.A.*<sup>1,2</sup>, *Zhuravlev I.S.*<sup>1,2</sup>, *Minin M.M.*<sup>1,2</sup>, *Bezzubov S.I.*<sup>1</sup>

<sup>1</sup> Kurnakov Institute of General and Inorganic Chemistry RAS, Moscow, Russia

<sup>2</sup> Moscow State University, Moscow, Russia

PhD student

[tatarin.sergei@yandex.ru](mailto:tatarin.sergei@yandex.ru)

Cyclometalated iridium(III) complexes comprise one of the most diverse classes of chromophoric molecules. Their efficient phosphorescence along with high stability predetermine their extensive exploration as emitters in organic light-emitting diodes and bioimaging agents. Still, one of their major drawbacks for their use as dyes in solar cells or as photocatalysts for hydrogen generation is relatively low light absorption in the visible and NIR spectral regions. The present work is devoted to the study of various approaches for obtaining intensively absorbing complexes for their subsequent application in photovoltaic devices and for various photoactivatable processes.

Firstly, it was shown that tailoring of the size and position of the  $\pi$ -conjugated system in cyclometalated benzimidazole ligands leads to formation of stable complexes with improved, but still limited to a region 400–600 nm, light absorption [1]. Fine-tuning of the electronic properties of substituents in both cyclometalated and ancillary ligands allowed us to increase the efficiency of the corresponding solar cells, yet the absorption of the studied complexes remained limited [2].

The use of rigid anthracene fragments in a cyclometalated benzimidazole ligand leads to formation of a non-trivial *mono*-cyclometalated complex, which turned out to be extremely labile for photovoltaic applications, though its absorption maxima were shifted bathochromically. Thus, classical approaches of ligands modifications were shown to have several limitations in terms of absorption wavelengths of the resulting complexes.

Therefore, we decided to explore a number of other ligands classes in order to further increase molar extinction coefficients and absorption wavelengths of the complexes. In particular, cyclometallation of a compact yet rigid polyaromatic monobenzophenazine ligand led to formation of an unexpected *bis*-cyclometalated acetate complex, which, however, demonstrated long-wavelength (600 nm+) absorption and can act as a precursor for red and near-infrared emitters. Finally, the use of redox-active catechol-like ancillary ligands led to formation of stable radical complexes with absorption bands tailing up to 800 nm.

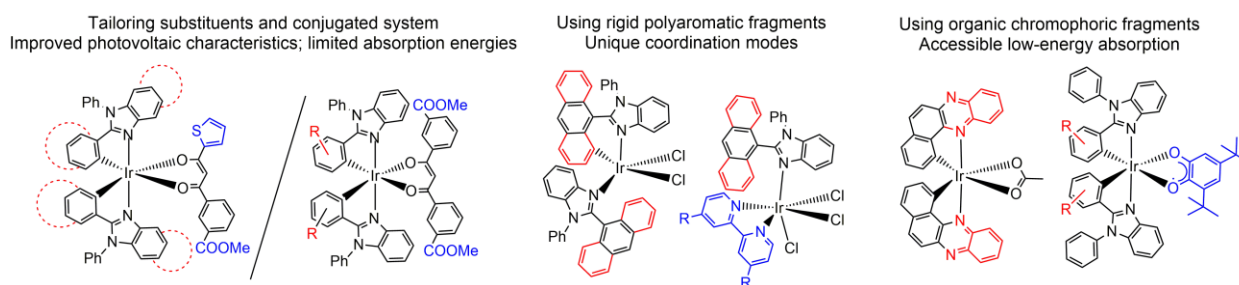

**Scheme 1.** Main strategies for tuning absorption in cyclometalated iridium(III) complexes probed in this work

## References

- [1] *Dalton Trans.* **2023**, 52, 6345
- [2] *Dalton Trans.* **2023**, 52, 16261

# COCRYSTALS OF $\text{Cu}_4\text{I}_4$ -CLUSTERS CONTAINING PERFLUOROARENE MOLECULES: STRUCTURAL AND LUMINESCENT STUDIES

*Toikka Y.N.<sup>1</sup>, Bokach N.A.<sup>1</sup>*

<sup>1</sup> St. Petersburg State University, St. Petersburg, Russia

PhD

[y.toikka@spbu.ru](mailto:y.toikka@spbu.ru)

Copper(I) halide cubane-like clusters  $\text{Cu}_4\text{I}_4\text{L}_4$  have received continuous research attention due to their significance as catalysts for organic reactions, development of new materials with photo- and electroluminescent, sorption, and sensor properties [1]. However, the features of  $\text{Cu}_4\text{I}_4$ -clusters with dialkylcyanamides (on example  $\text{NCNMe}_2$ ) [2] such as ability these clusters to form co-crystals with  $\sigma$ -/ $\pi$ -hole or halogen bond(HB) donors - perfluoroarenes, their crystalline structure that is determined by various types noncovalent interactions and luminescent properties that depend on kind of donor molecule, was poorly studied yet.

Cocrystals of cubane copper(I) clusters, namely  $[\text{Cu}_4\text{I}_4(\text{NCNMe}_2)_4]$  (**1**) with such combined  $\sigma$ -/ $\pi$ -hole donors as 1,4-diiidotetrafluorobenzene (1,4-FIB), 1,4-dibromotetrafluorobenzene (1,4-FBrB), iodoperfluorobenzene (IFB), 4,4'-diiiodoperfluorobiphenyl (4,4'-FIBP), 4-bromoperfluorobenzonitrile (4-BrFBN) and 4-iodotetrafluoropyridine (4-IFPy) were previously prepared and characterized by single-crystal X-ray diffractometry (XRD), IR and luminescent spectroscopy [3]. All cocrystals display different structural parameters expectedly in view of their different composition. In the all structures of cocrystals, we verified weak hydrogen intramolecular contacts  $\text{H}\cdots\text{I}$ ,  $\pi$ -stacking occurred between electron deficient aromatic systems and iodide ligand(s) (or the  $\text{Cu}_4\text{I}_4$  fragment) of the clusters and halogen bonds  $\text{I}(\text{Br})\cdots\text{I}(\text{Cu}_4\text{I}_4)$ . An interplay between these two types of noncovalent interactions along with other noncovalent forces, determine the crystal structure of the co-crystals. In addition, in **1**·2(IFB), **1**·4,4'-FIBP, **1**·4-BrFBN, arene  $\pi$ -hole $\cdots\text{I}$  contacts,  $\text{N}_{\text{C}=\text{N}}\cdots$  arene  $\pi$ -hole contacts were found and described.

The prepared clusters luminesce at room temperature in the solid state with an emission maximum in the range of 540-600 nm upon excitation at 330-365 nm. The lifetimes of this range of cocrystals changed little, but the quantum yields of cocrystals were significantly reduced compared to compound **1**.

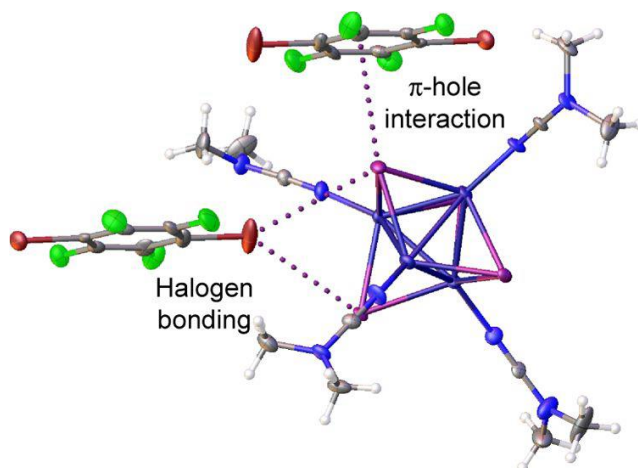

**Figure 1.** Different types of noncovalent bonding - halogen bond and  $\pi$ -hole interactions in compound **1**·1,4-FBrB.

## References

- [1] *Chem. Soc. Rev.* **2021**, 50, 4606
- [2] *Rus. J. Gen. Chem.* **2022**, 92, 1275
- [3] *Cryst. Growth & Design* **2023**, 7, 5194

## Acknowledgements

This work was supported by the Russian Science Foundation (project № 22-13-00078).

# METAL-ORGANIC FRAMEWORKS BASED ON $\{Zn_{12}\}$ AND $\{Zn_{10}\}$ CARBOXYLATE WHEELS AS POTENTIAL ADSORBENTS AND SENSORS

*Tomas M.A.*<sup>1</sup>

<sup>1</sup> Nikolaev Institute of Inorganic Chemistry, Novosibirsk, Russia

Student, no academic title

[m.tomas@g.nsu.ru](mailto:m.tomas@g.nsu.ru)

Metal-organic frameworks (MOFs) are an emerging class of microporous solids that, due to their structural and functional diversity, have been intensively studied over the past two decades, which subsequently led to their potential use as gas adsorbents, luminescent sensors, catalytic, optical and magnetic materials [1].

In the synthesis of MOFs, carboxylates are most often used as bridging ligands. A greater variety of structures can be achieved by introducing an additional N-donor bridging ligand. The use of a third bridging ligand in the synthesis of MOFs rarely leads to its inclusion in the coordination polymer due to the low probability of self-assembly of a complex polymer complex consisting of metal ions and three bridging ligands. Nevertheless, two series of new three-dimensional (3D) MOFs based on three types of bridging ligands (carboxylate, N-donor ligand and glycols: ethylene glycol, 1,2-propanediol, 1,2-butanediol, 1,2-pentanediol and glycerol) were recently obtained in our laboratory [2, 3]. This work is a continuation of these studies. Here, we have obtained two series of new 3D MOFs based on carboxylate rings  $\{Zn_{12}\}$  or  $\{Zn_{10}\}$  linked to each other by 2,5-furandicarboxylates ( $fdc^{2-}$ ), 1,4-diazabicyclo[2.2.2]octane (dabco) and deprotonated glycols  $GIO_2^{2-}$ .

The first series of compounds  $[Zn_{12}(fdc)_6(dabco)_3(GIO_2)_6] \cdot xDMF \cdot yH_2O$  (DMF = N,N-dimethylformamide,  $GIO_2^{2-}$  = 1,2-ethanediolate, 1,2-propanediolate, 1,2-butanediolate and 1,2-pentanediolate) is isostructural to compounds of the NiIC-20 series [3] and has mesopores with a size of 25 Å, the entrances to which are realized through carboxylate rings  $\{Zn_{12}\}$  functionalized by glycolate residues. The second series of compounds  $[Zn_{10}(fdc)_4(dabco)(GIO_2)_6] \cdot xDMF \cdot yH_2O$  ( $GIO_2^{2-}$  = 1,2-propanediolate, 1,2-butanediolate and 1,2-pentanediolate) is completely new, obtained with a high  $[Zn^{2+}]:[dabco]$  ratio and has elliptical cavities of size  $(14 \times 14 \times 18)$  Å<sup>3</sup> connected to each other.

The first series of the compounds has a sufficiently large pore volume (up to 0.562 cm<sup>3</sup>/g, CO<sub>2</sub>, 195 K), therefore, they showed high values of adsorption capacity for volatile organic compounds (up to 0.47g/g for benzene at r.t.), which makes these materials promising for air purification. It also demonstrated a luminescence response for some inorganic cations in solutions, which can be used for their luminescence detection.

## References

- [1] N. Stock, Sh. Biswas. Synthesis of Metal-Organic Frameworks (MOFs): Routes to Various MOF Topologies, Morphologies, and Composites. *Chem. Rev.*, 2012, 112 (2), 933-969.
- [2] A. A. Lysova, D. G. Samsonenko, P. V. Dorovatovskii, V. A. Lazarenko, V. N. Khurstalev, K. A. Kovalenko, D. N. Dybtsev, V. P. Fedin. *J. Am. Chem. Soc.*, 2019, 141, 17260-17269.
- [3] A. A. Lysova, D. G. Samsonenko, K. A. Kovalenko, A. S. Nizovtsev, D. N. Dybtsev, V. P. Fedin. *Angew. Chem. Intern. Ed.*, 2020, 59, 20561-20567.

## Acknowledgements

The work was supported by the Russian Science Foundation (project № 23-13-00310).

## A NEW DIMERIC THIOCARBAMIDE COMPLEX OF RUTHENIUM

Komarovskikh M.R., Tytmina N.D., Tereshina T.A., Dobrokhotova E.V., Rudnitskaya O.V., Kultyshkina E.K., Khrustalev V.N.

RUDN University, Moscow, Russia  
Student  
[dobrokhotova-ev@rudn.ru](mailto:dobrokhotova-ev@rudn.ru)

Despite the fact that the analytical reaction to ruthenium with thiocarbamide has been known for a long time, only very few structures of ruthenium thiocarbamide complexes have been characterized by x-ray structure analyses. Thiocarbamide is capable of breaking down in solutions to form sulfur, which probably contributed to the formation of a new thiocarbamide complex of ruthenium (II) with a disulfide bridge.

Yellow-green crystals (*Fig. 1*) of  $[(SC(NH_2)_2)_5Ru^{II}S-SRu^{II}(SC(NH_2)_2)_5]Cl_4$  were obtained by the reaction of «RuCl<sub>3</sub>» with SC(NH<sub>2</sub>)<sub>2</sub> in HCl<sub>aq</sub>. Structure was established by x-ray structure analyses: the compound crystallizes in triclinic syngony, space group  $P\bar{1}$ ,  $a = 8.4533(2)$ ,  $b = 11.4113(2)$ ,  $c = 11.5068(3)\text{\AA}$ ,  $V = 1062.19(4)\text{\AA}^3$ ,  $Z = 1$ .

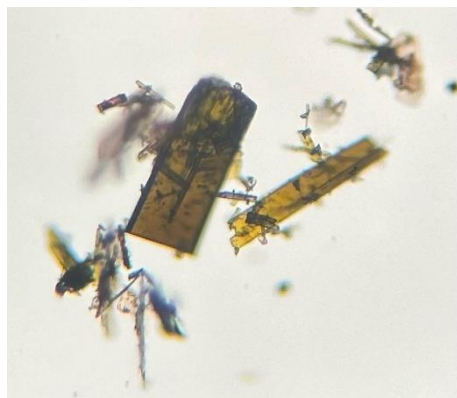

**Figure 1.** Photo of crystals

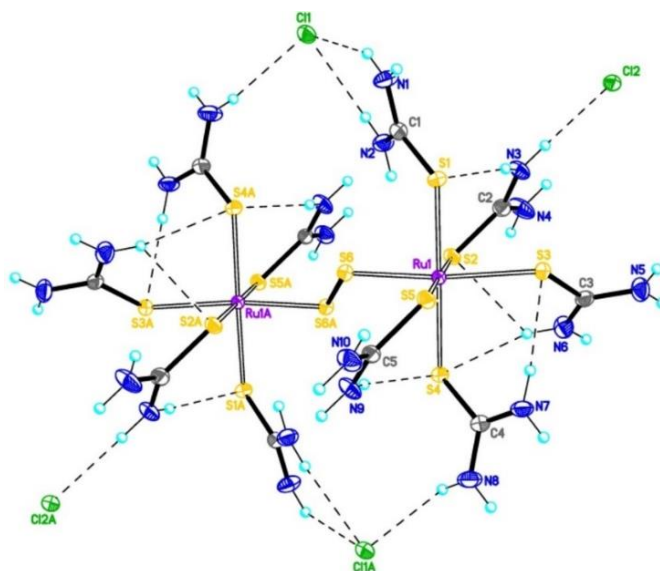

**Figure 2.** Structure of  $[(SC(NH_2)_2)_5RuS-SRu(SC(NH_2)_2)_5]Cl_4$

In the cation the S-S bond is single (2.0037(17)Å), Ru-S(6) distance is 2.2289(9)Å and Ru(1)-S(1-5) are amount to 2.4050(8)-2.445(1)Å, respectively. The cation adopts the most energetically advantageous gauche conformation, and the thiocarbamide fragments retain a flat structure. Protons of thiocarbamide molecules are involved in the formation of hydrogen bonds N-H...S with sulfur atoms inside the  $[(SC(NH_2)_2)_5RuS-SRu(SC(NH_2)_2)_5]^{4+}$  cation and N-H...Cl with Cl<sup>-</sup> anions in the outer sphere (*Fig.2*).

# PECULIARITIES OF COORDINATION OF WATER MOLECULES IN MIXTURES OF IONIC LIQUIDS AND WATER, CONTAINING $\text{Al}^{3+}$ CATION

*Ubovich M.<sup>1</sup>, Mukhin K.A.<sup>1</sup>, Mazur Ya.E.<sup>2</sup>*

<sup>1</sup> St. Petersburg State University, St. Petersburg, Russia

<sup>2</sup> Saint Petersburg State University of Industrial Technologies and Design, St. Petersburg, Russia  
PhD Student

[ubovich.milosh@yandex.ru](mailto:ubovich.milosh@yandex.ru)

Electrolytes based on solutions of aluminum salts in ionic liquids (ILs) can be used in metal-ion batteries. These salts exist usually in a form of the crystalline hydrates, i.e. contain sufficient amount of water. As a result, one has mixed "IL – water" solvents, and water cannot be removed from the aluminum solvation shell by standard dehydration procedures [1, 2]. Earlier the mixtures of IL [bmim]Cl (1-butyl-3-methylimidazolium chloride,  $\text{C}_8\text{H}_{15}\text{N}_2\text{Cl}$ ) and aluminum chloride ( $\text{AlCl}_3$ ) with different water amount were investigated [3]. The existence of different solvate complexes of  $\text{Al}^{3+}$  with  $\text{Cl}^-$  in considered systems was detected. In addition, the characteristic times of exchange processes were estimated according to NMR data. It was demonstrated that the  $\text{Al}^{3+}$  cation can strongly hold more than 6  $\text{H}_2\text{O}$  molecules in its nearest surroundings.

This work is an extension of the study of the state of water molecules in triple systems "aluminum salt/IL/water", namely:  $\text{Al}(\text{NO}_3)_3 \cdot n\text{H}_2\text{O}$  in EAN (ethylammonium nitrate) and  $\text{AlCl}_3 \cdot n\text{H}_2\text{O}$  in EACl (ethylammonium chloride).

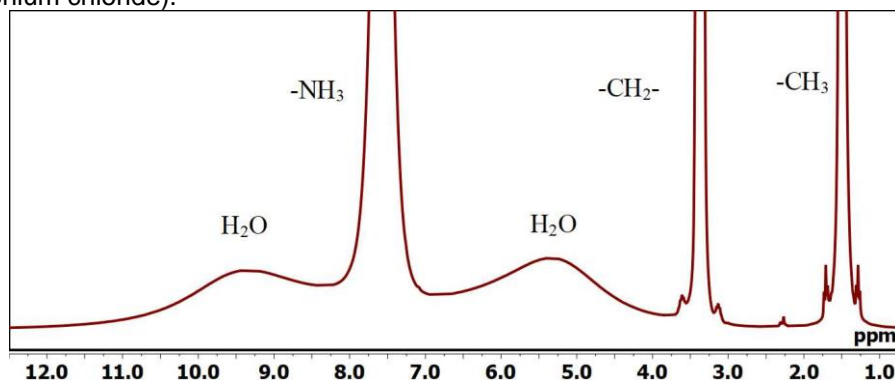

**Figure 1.** The  $^1\text{H}$  spectrum (300 MHz) for the " $\text{Al}(\text{NO}_3)_3 - \text{EAN} - \text{H}_2\text{O}$ " mixture at 298 K.

The samples were prepared by mass method using crystalline hydrates of aluminum chloride and aluminum nitrate. Due to low commercial availability, EAN and EACl ionic liquids have been synthesized. The composition and purity of the synthesized ILs were controlled by  $^1\text{H}$  and  $^{14}\text{N}$  NMR. Water content in the solutions was changed using a standard drying procedure under low pressure at  $80^\circ\text{C}$  and controlled by  $^1\text{H}$  spectra.

NMR measurements were carried out using Bruker Avance III 500 MHz Spectrometer at 500 MHz for  $^1\text{H}$  nuclei, 130 MHz for  $^{27}\text{Al}$  nuclei, and 36 MHz for  $^{14}\text{N}$  nuclei in the temperature range between 293 and 363 K (with increment 10 K). Some preliminary measurements of  $^1\text{H}$  spectra were also made by Bruker DPX 300 MHz Spectrometer at 300 MHz. In all studied solutions several water lines were recorded (see the example in Fig. 1). In order to interpret the obtained experimental data quantum chemical calculations were performed by Gaussian 09 Revision D.01 [4].

## References

- [1] *J. Mol. Liq.* **2019**, 278, 239.
- [2] *Magn. Reson. Chem.* **2021**, 60(2), 221.
- [3] *J. Phys. Chem. Lett.* **2023**, 14, 9324.
- [4] Gaussian 09, Revision D.01. Gaussian, Inc., Wallingford CT, **2013**.

## Acknowledgements

This work was supported by the Russian Science Foundation (project № 23-23-00049). All NMR measurements were carried out in the Resource Center "Magnetic Resonance Research Methods" of Research Park of Saint Petersburg State University.



# SYNTHESIS, OPTICAL AND ELECTROCHEMICAL PROPERTIES AND ELECTRONIC STRUCTURE OF CYCLOMETALATED RU(II) COMPLEXES WITH 1-BENZYL-2-ARYLBENZIMIDAZOLES WITH DONOR SUBSTITUENTS IN THE BENZIMIDAZOLE FRAGMENT

*Verzun S.A.<sup>1</sup>, Lavrova M.A.<sup>1</sup>, Mishurinskii S.A.<sup>1</sup>, Feoktistova A.V.<sup>1</sup>, Bytskevich Yu.M.<sup>1</sup>, Sirotnin M.A.<sup>1,2</sup>, Korshunov V.M.<sup>3</sup>, Dolzhenko V.D.<sup>1</sup>*

<sup>1</sup> Chemistry Department, M.V. Lomonosov Moscow State University, Moscow, Russia

<sup>2</sup>N.N. Semenov Federal Research Center for Chemical Physics, Moscow, Russia

<sup>3</sup>P.N. Lebedev Physical Institute of the Russian Academy of Sciences, Moscow, Russia  
Student

[stepan.verzun@mail.ru](mailto:stepan.verzun@mail.ru)

Ru(II) polypyridine complexes are used as photosensitizers in dye sensitized solar cells, and show excellent results. Standard dyes containing monodentate -NCS ligands are labile, so the operation time of the cells is not enough for their commercial use. To increase stability, cyclometalated complexes (containing a five-membered cycle with a covalent Ru-C bond) may be used. However, such a significant change in the structure of the complex entails a change in its characteristics and a loss of operating efficiency in the cell. Therefore, an urgent task remains to study the influence of the cyclometalated ligand on the properties of the complex.

Earlier, in the study of Ru(II) complexes with 1-phenyl-2-arylbenzimidazoles [1], we found that with an increase in the donor content of the substituent in the aryl fragment of benzimidazole, a large contribution of intra-ligand transfer from the aryl fragment to the acceptor benzimidazole fragment of the ligand appears. This process is parasitic, and as a way to solve this problem, we propose to introduce donor substituents (methyl and methoxy groups) into the benzimidazole fragment.

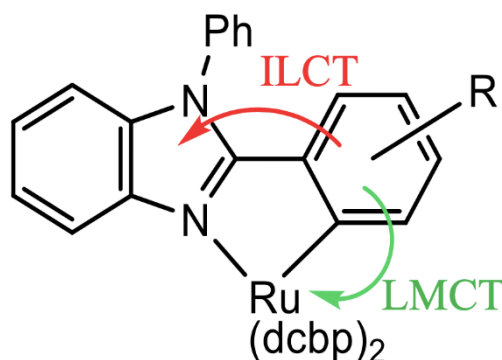

**Scheme 1.** The conflict between ILCT and LMCT in the donor ligand

The objects of this study are ruthenium(II) complexes of the composition  $[\text{Ru}(\text{dmdcbp})_2\text{L}]\text{PF}_6$ , where  $\text{dmdcbp}$  = dimethyl ester of 4,4'-dicarboxy-2,2'-bipyridine,  $\text{L}$  = 1-benzyl-2-(4-R-phenyl)-5-R'-benzimidazole ( $\text{R} = -\text{H}, -\text{NO}_2, -\text{NMe}_2, -\text{OMe}$ ,  $\text{R}' = 5-\text{CH}_3, 5-\text{OCH}_3, 5,6-(\text{OCH}_3)_2$ ). The ester of 4,4'-dicarboxy-2,2'-bipyridine was used as an anchoring ligand in standard dyes. We used ester instead of the acid in order to increase solubility of complexes for easier investigation in solutions.

The obtained ligands and complexes were characterized by NMR spectroscopy and mass spectrometry. Optical absorption and luminescence were studied, the redox-potentials of the obtained complexes were determined, and X-ray diffraction analysis of single crystals of some of the complexes was carried out. It was found that the introduction of donor substituents into the aryl fragment of the ligand results in a bathochromic shift in the absorption and emission maxima. All the obtained compounds exhibit phosphorescence in the near-infrared region (800-950 nm), as confirmed by recording luminescence decay curves at room temperature and at 77K [2].

## References

[1] *Dalton Transactions*, **2020**, 49(46), 16935-16945.

[2] *Molecules*, **2023**, 28(18), 6541.

# SYNTHESIS AND STRUCTURE OF MONONUCLEAR COPPER(I) COMPLEXES WITH ISOCYANIDES LIGANDS

*Vlassova V.V.<sup>1</sup>, Bokach N.A.<sup>1</sup>*

<sup>1</sup> St. Petersburg State University, Institute of Chemistry, St. Petersburg, Russia, Student [st081211@student.spbu.ru](mailto:st081211@student.spbu.ru)

Copper(I) complexes attract the constant attention of researchers and are widely used in various fields – in metal complex catalysis, crystal engineering, as new fluorescent materials. Copper isocyanide complexes are promising objects for studying their supramolecular organization and creating new materials. Copper(I) coordination compounds contain several centers capable of participating in the formation of non-covalent contacts (metal center, CN group of isocyanide ligand, additional functional groups in isocyanide ligands, anionic ligands), which opens up many possibilities for fine-tuning the properties of compounds.

We have obtained a series of  $[\text{CuX}(\text{CNR})_3]$  complexes ( $\text{X}=\text{Cl}, \text{Br}, \text{I}$ ;  $\text{R}=(\text{C}_6\text{H}_3\text{-}2,6\text{-Cl}_2, \text{C}_6\text{H}_3\text{-}2\text{-Cl-}6\text{-Me}, \text{C}_6\text{H}_3\text{-}2,6\text{-Br}_2, \text{C}_6\text{H}_3\text{-}2\text{-Br-}6\text{-Me})$ ). The compounds were characterized by  $^1\text{H}$  NMR and IR spectroscopies, mass spectrometry and atomic absorption analysis (Cu). The structures of the compounds in the solid phase were determined on the basis of XRD data (Figure 1).

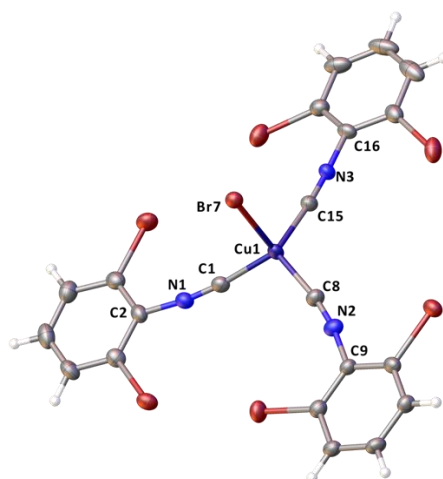

**Figure 1.** The molecular structure of the  $[\text{CuBr}(\text{CNC}_6\text{H}_3\text{-}2,6\text{-Br}_2)_3]$  complex.

## References

- [1] *Applied Organometallic Chemistry*. **2021**, 35, 6401
- [2] *Chemical Society Reviews*. **2020**, 49, 7730
- [3] *Journal of the American Chemical Society*. **2012**, 134, 8786

## Acknowledgements

This work was supported by the Russian Science Foundation (project No 22-13-00078).

## SYNTHESIS AND PROPERTIES OF PRASEODYMIUM-BARIUM COBALTITES

*Yagovitin R.E.*<sup>1</sup>, *Ivanov I.L.*<sup>1</sup>, *Tsvetkov D.S.*<sup>1</sup>, *Malyshkin D.A.*<sup>1</sup>, *Sereda V.V.*<sup>1</sup>, *Zuev A.Yu.*<sup>1</sup>

<sup>1</sup>Ural Federal University named after the first President of Russia B. N. Yeltsin, Ekaterinburg, Russia  
Graduate student  
[roman.iagovitin@urfu.ru](mailto:roman.iagovitin@urfu.ru)

Cobaltites of rare-earth and alkaline-earth metals have received great attention due to their properties such as high conductivity and cobalt atoms spin transitions. Mentioned properties determine usage of cobaltites in different electrochemical and magnetic devices. Nowadays double perovskite  $\text{PrBaCo}_2\text{O}_{6-\delta}$  is the most studied oxide in system Pr – Ba – Co – O. At the same time properties of other oxides in mentioned system are studied poorly. Present work is dedicated to synthesis and studying properties of praseodymium-barium cobaltites with general formula  $\text{Pr}_{1-x}\text{Ba}_x\text{CoO}_{3-\delta}$ .

Synthesis of complex oxides was carried out by using a standard ceramic technique.  $\text{Pr}_6\text{O}_{11}$ ,  $\text{BaCO}_3$  and  $\text{Co}_3\text{O}_4$  were used as starting materials. Phase composition of prepared samples was studied by using an X-ray diffraction method (diffractometer Equinox 3000). Thermal expansion of cobaltites was studied by using a high-temperature X-ray diffraction method (diffractometer XRD 7000) and dilatometry method (dilatometer DIL 402 C). Electrophysical properties of oxides were studied by using a four-probe method. Oxygen nonstoichiometry of praseodymium-barium cobaltites was studied by using a thermogravimetric analysis method (thermobalances STA 409PC Luxx).

It was shown that cobaltites  $\text{Pr}_{1-x}\text{Ba}_x\text{CoO}_{3-\delta}$  can be synthesized in air atmosphere at 1200 °C. Synthesis at lower temperatures leads to formation of  $\text{PrCoO}_{3-\delta}$  and  $\text{PrBaCo}_2\text{O}_{6-\delta}$  mixtures. Single-phase oxides can be synthesized only if  $x$  is no more than 1/3. If  $1/3 < x < 0.5$  mixture of  $\text{PrBaCo}_2\text{O}_{6-\delta}$  and  $\text{Pr}_{2/3}\text{Ba}_{1/3}\text{CoO}_{3-\delta}$  is formed. It didn't manage to synthesis oxides with  $0.5 < x < 1$ , mixture of  $\text{BaCoO}_{3-\delta}$  and  $\text{PrBaCo}_2\text{O}_{6-\delta}$  was formed. All single-phase samples have the similar structure with orthorhombic  $Pbnm$  elementary cell. All single-phase samples are stable in air atmosphere: decomposition of complex oxides wasn't detected after annealing at 1100 °C during a month. For samples with  $0.05 \leq x \leq 0.15$  additional high-temperature phase transitions were detected. Temperature of phase transition decreases with barium atoms concentration increasing. It was shown that for sample with composition  $\text{Pr}_{0.95}\text{Ba}_{0.05}\text{CoO}_{3-\delta}$  orthorhombic modification transforms in rhombohedral one.

All prepared samples can take part in reversible oxygen exchange process with atmosphere. Increasing of barium concentration in oxide leads to increasing of oxygen exchange intensity between oxide and atmosphere. Also, it was shown that for oxides with  $x < 0.3$  oxygen content is equal to three can be reached in air atmosphere.

For oxides with relatively low barium atoms concentration ( $x \leq 0.1$ ) spin transitions of cobalt atoms dramatically influence on properties of oxides. For example, that transitions lead to increasing of oxide's thermal expansion coefficient and conductivity activation energy. Effect of spin transitions decreases with barium atoms concentration increasing. For oxides with high barium atoms concentration ( $x > 0.1$ ) oxygen exchange process determines properties of oxides. As an example, oxygen exchange leads to increasing of oxide's chemical expansion at high temperatures. Reason of observed effect is change of cobalt atoms concentrations in different oxidation state with oxygen content change. It was shown that barium atoms concentration increasing leads to decreasing of oxide's thermal expansion coefficient in oxide's constant composition temperature range. In temperature range 25 – 1000 °C praseodymium-barium cobaltites have thermal expansion coefficient is about  $(20 - 25) \cdot 10^{-6} \text{ K}^{-1}$ . Increasing of barium atoms concentration in oxide leads to increasing of general conductivity at room temperature caused by hole's concentration increasing. Temperature dependences of conductivity for prepared oxides are characterized by maximum. Maximum temperature significantly decreases with barium atoms concentration increasing. Such behavior of oxides was explained by influence of two effects: increasing of charge carriers' mobility with temperature increasing and conductivity decreasing caused by oxygen exchange process with atmosphere. Seebeck coefficients measurements allowed to conclude that holes are dominating charge carriers in prepared oxides. Also, it was shown that conductivity activation energy decreases with barium atoms concentration increasing.

# NUCLEAR MAGNETIC RESONANCE IN LANTHANUM SUPERHYDRIDES

Zhou D.<sup>1</sup>, Semenov D.V.<sup>1</sup>

<sup>1</sup> Center for High Pressure Science & Technology Advanced Research  
Bldg. 8E, ZPark, 10 Xibeiwang East Rd, Haidian District, Beijing, 100193, P.R. China

PhD, post doc

[di.zhou@hpstar.ac.cn](mailto:di.zhou@hpstar.ac.cn)

Nuclear magnetic resonance (NMR) is one of the most powerful methods for determining the structure of chemical compounds. Its importance in organic chemistry is enormous, while in the study of solids the role of NMR is less due to broadening of NMR signals. Despite this, the solid-state NMR allows to obtain a lot of information about the physical processes occurring in a substance. An example of such a field, in which solid-state NMR plays a major role, is superconductivity (SC).

Lanthanum hydride LaH<sub>10</sub> is a SC polyhydride with the highest critical temperature ( $T_C \approx 250$  K) among known compounds [1,2]. For this reason, the La-H system is one of the most attractive objects for solid-state NMR research. In this work, the formation of La polyhydrides was studied in diamond anvil cells at pressures up to 165 GPa in a temperature range from 5 to 300 K. To detect nuclear induction signals from the hydrogen spin-system in our micros samples ( $d \approx 30 \mu\text{m}$ ,  $t \approx 5 \mu\text{m}$ ), we used a system of Lenz lenses [3,4] sputtered on pavilions of diamond anvils. La metal and LaH<sub>3</sub> were used as a starting material, while ammonia borane complex (NH<sub>3</sub>BH<sub>3</sub>, AB) served as a hydrogen source.

After high-temperature high-pressure synthesis of lanthanum polyhydrides, we observed a sharp weakening of the <sup>1</sup>H NMR signal below 227 K in a magnetic field of 7 T, corresponding to the screening of radiofrequency field by LaH<sub>10±1</sub> in the Meissner state. At the same temperature the NMR frequency shift, width of peaks and their intensity demonstrate a pronounced leap, whereas the spin-lattice relaxation time  $T_1$  exhibits the Hebel-Slichter peak, characteristic of the Bardeen–Cooper–Schrieffer superconductors. Finally, an exponential decrease in the relaxation rate  $1/T_1$  as the temperature decreases below  $T_C$ , allowed to estimate the superconducting gap in LaH<sub>10</sub> as  $\Delta(0) = 36.8 \pm 4$  meV, and  $R_\Delta = 2\Delta(0)/k_B T_C = 3.76 \pm 0.42$  which serves as strong arguments in favor of conventional electron-phonon superconductivity in LaH<sub>10</sub>.

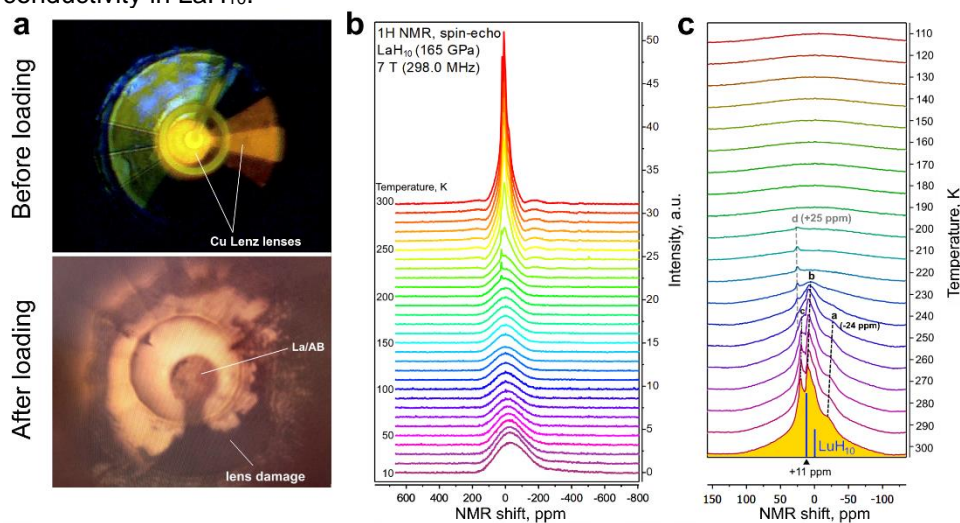

**Scheme 1.** <sup>1</sup>H NMR in La polyhydrides. (a) Photographs of the anvil culet with sputtered Lenz lenses before and after loading and compression to 165 GPa. (b) Stack of <sup>1</sup>H NMR spectra recorded in a cooling cycle from 300 K to 10 K in steps of 10 K. The curves correspond to the signal magnitude. (c) Zoom in of the <sup>1</sup>H NMR signal as a function of temperature.

## References

- [1] Nature **2019**, 569, 528  
[2] Phys. Rev. Lett. **2019**, 122, 027001  
[3] Sci. Adv. **2017**, 3, eaa05242  
[4] Matter and Radiation at Extremes **2021**, 6

## Acknowledgements

D. S. and D. Z. thank National Natural Science Foundation of China (NSFC, grant No. 12350410354) and Beijing Natural Science Foundation (grant No. IS23017) for support of this research. D. Z. thanks China Postdoctoral Science Foundation (Certificate No. 2023M740204) and financial support from HPSTAR.

# SYNTHESIS AND CRYSTAL STRUCTURE OF $\text{SrFe}_{12-x}\text{Cr}_x\text{O}_{19}$ WITH HIGH CHROMIUM SUBSTITUTION LEVEL ( $x = 0-6$ )

*Zykova A.R.*<sup>1</sup>, *Kovalev A.I.*<sup>1</sup>, *Sherstyuk D.P.*<sup>1</sup>, *Zhivulin V.E.*<sup>1</sup>, *Vinnik D.A.*<sup>1,2,3</sup>

<sup>1</sup>South Ural State University, Chelyabinsk, Russia

<sup>2</sup>St. Petersburg State University, St. Petersburg, Russia

<sup>3</sup>Moscow Institute of Physics and Technology, Dolgoprudny, Russia

PhD

[zykovaar@susu.ru](mailto:zykovaar@susu.ru)

Ferrites with a magnetoplumbite structure deserve special attention due to their unique properties and crystalline structure [1]. Of great interest is the replacement of iron with chromium ions, since chromium has a lower magnetisation and a radius close to iron, due to which it is possible to modify the structure and vary the magnetic properties [2]. However, it is difficult to obtain strontium hexaferrites with high degree of substitution. The problem is the controlled production of single-phase material with high degrees of substitution of iron for other ions.

Thus, our work aims to investigate synthesis, structural and morphological properties of Sr hexaferrites of M-type with wide range of Cr substitution  $\text{SrFe}_{(12-x)}\text{Cr}_x\text{O}_{19}$  ( $x = 0-6$ ) with a step  $x = 0.5$ .

Solid-state synthesis was chosen to achieve the aim of the work. Solid-state synthesis was lasted for 5 hours at the temperature of 1400°C. The phase composition and unit cell parameters of the obtained samples were determined through X-ray diffraction. Scheme 1 show the X-ray patterns of single-phase samples. When strontium hexaferrite is substituted by chromium, the values of the parameters  $a$ ,  $c$ ,  $V$  change monotonically (scheme 2). Since the ionic radius of  $\text{Cr}^{3+}$  (0.615 Å) is smaller than that of  $\text{Fe}^{3+}$  (0.645 Å), the unit cell and its parameters decreased with  $x$ .

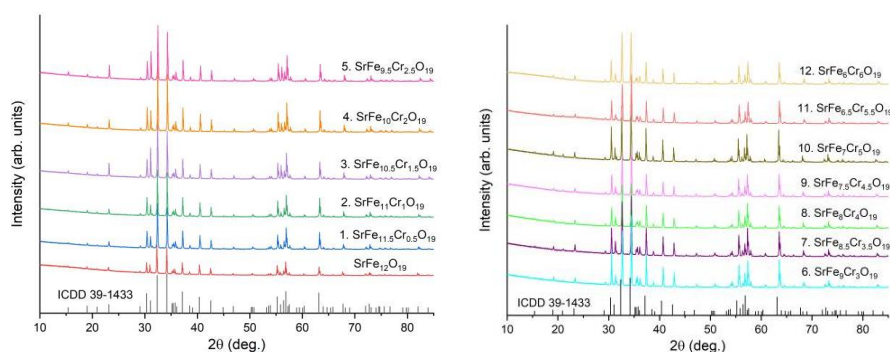

**Scheme 1.** XRD patterns of  $\text{SrFe}_{(12-x)}\text{Cr}_x\text{O}_{19}$

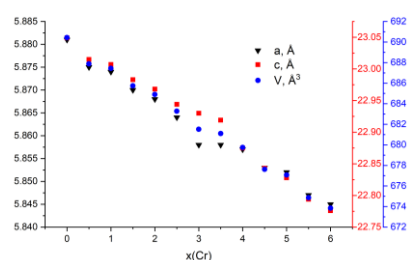

**Scheme 2.** Cell parameters  $a$ ,  $c$ ,  $V$  dependence on Cr concentration

Thus, single-phase samples of strontium hexaferrite doped with chromium with high degrees of iron substitution have been successfully synthesized by the solid-phase method with a promising study of their magnetic properties for application in modern technology.

## References

- [1] *Phys. B Condens. Matter* **2024**, *681*, 415840
- [2] *AIP Conf. Proc.* **2018**, *1942*, 130040

## Acknowledgements

The study was supported by the Russian Science Foundation grant No. 24-29-20187, <https://rscf.ru/project/24-29-20187/>

# SYNTHESIS AND STRUCTURE OF NOVEL MANGANESE CARBOXYLATE POLYMERS

Zykov S.I.<sup>1</sup>, Kuramshin B.K.<sup>1</sup>, Mironov V.A.<sup>1</sup>, Shtyrlin V.G.<sup>1</sup>

<sup>1</sup> Kazan Federal University, Kazan, Russia

Student

[marcusinform@mail.ru](mailto:marcusinform@mail.ru)

A detailed studies of manganese(II) and carboxylate ligands bonding have continued over the past several decades. Interest in the topic is primarily related to a bioinorganic aspect: manganese catalases, superoxide dismutase, Photosystem II contain coordination nodes including manganese coordinated with carboxylate groups. Coordination polymers are also a subject of particular structural interest. Lability of Mn(II) cations allows to synthesize a great variety of coordination polymers in similar conditions, what is actually demonstrated in this work: this factor facilitates the development of synthesis of manganese coordination polymers and makes it harder to choose the optimal conditions of synthesis.

Two acetate and one succinate anionic polymers, containing sodium and potassium cations, were synthesized:  $K_2Mn_3(CH_3COO)_8$ ,  $NaMn_2(CH_3COO)_5$ ,  $K_4Mn_8(C_4H_4O_4)_9(HC_4H_4O_4)_2$ . The first two are one-dimensional chained polymers containing manganese in an octahedral surrounding, the last one is two-dimensional layered polymer that may be considered as MOF (pic.1). The forming of polymers is mainly regulated by the size of alkali metal cation, what is consistent with literature information about synthesis of  $(N(C_4H_9)_4)_2Mn_3(CH_3COO)_8$  in similar conditions, The large  $N(C_4H_9)_4^+$  cations do not seem to allow polymer assembly, potassium cations contribute to polymer assembly with the same stoichiometry, and even smaller sodium cations allow smaller anionic circuits of different composition to be assembled. Succinate polymer is held not only by coordination and ion interactions, but also by hydrogen interlayer bonds. Succinate ions in the composition of the polymer are coordinated both as interlayer binding and as intralayer tri- and tetradent bridge ligands.

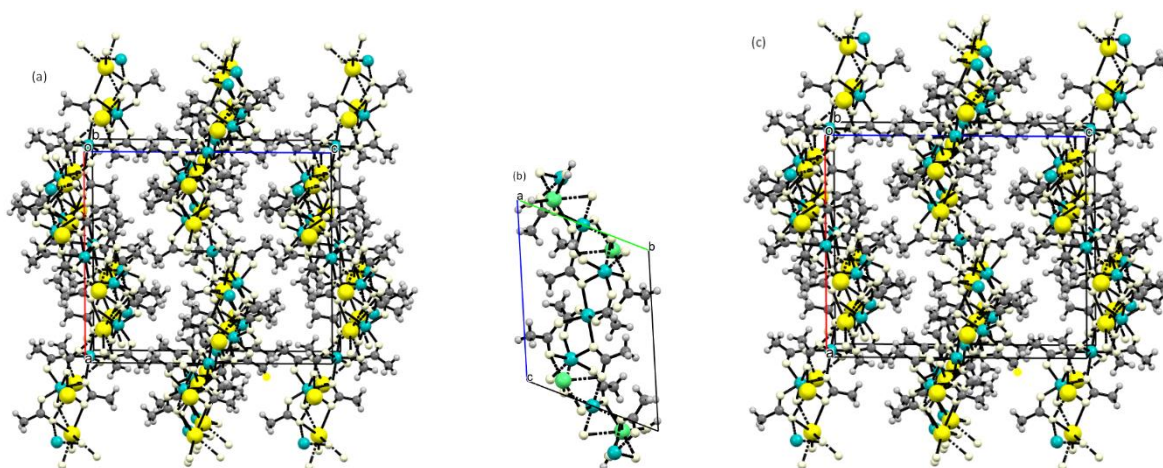

**Scheme 1.** Structures of polymeric (a)  $K_2Mn_3(CH_3COO)_8$ , (b)  $NaMn_2(CH_3COO)_5$ , (c)  $K_4Mn_8(C_4H_4O_4)_9(HC_4H_4O_4)_2$ .

## References

[1] *Inorg. Chem.* **1998**, 37, 1232-1241



# **ABSENTEE PARTICIPANTS**

CO-HYDROGENATION OF CARBON OXIDES ON Ca/Ba DOPED GdFeO<sub>3</sub>Akhmina P.V.<sup>1</sup>, Borodina E.M.<sup>1</sup>, Kryuchkova T.A.<sup>1</sup>, Sheshko T.F.<sup>1</sup><sup>1</sup> Peoples' Friendship University of Russia (RUDN University), Moscow, Russia

Master student

[akhmina-pv@pfur.ru](mailto:akhmina-pv@pfur.ru)

The pursuit of sustainable development has led to a global movement towards reducing greenhouse gas emissions and mitigating climate change. This makes it essential to develop environmentally friendly chemical processes that are more cost-effective, energy efficient, and resource-conserving than current methods. The increasing need to address the problem of carbon dioxide (CO<sub>2</sub>) accumulation in the atmosphere has prompted the development of new methods for its disposal. Catalytic processing of CO<sub>2</sub> into valuable chemical products is one promising approach. Direct hydrogenation of CO<sub>2</sub> using heterogeneous catalysts produces products such as synthesis gas, hydrocarbons, and light olefins [1-3].

In this work, a comprehensive study was conducted for the first time on the regularities of direct hydrogenation of a mixture of CO and CO<sub>2</sub> using catalytic systems with a perovskite structure Gd<sub>1-x</sub>(Ca/Ba)<sub>x</sub>FeO<sub>3</sub>, where x=0; 0,01; and 0,05. Ca/Ba promoted Fischer-Tropsch GdFeO<sub>3</sub> synthesis catalysts were prepared by sol-gel method and characterized by nitrogen adsorption, X-ray diffraction, and Fourier-transform IR spectroscopy. Their acid-base properties and oxygen non-stoichiometry were also investigated. The non-isovalent partial substitution of Gd by Ca<sup>2+</sup>/Ba<sup>2+</sup> led mainly to an increase in the basicity of the surface (q increase at pK<sub>a</sub>=9.4) and a slight increase in the number of acid centers (pK<sub>a</sub>=3.8).

Their performances of modified (CO+CO<sub>2</sub>) Fischer-Tropsch synthesis were evaluated in a fixed bed reactor. The result indicated that Ca/Ba promoter can promote oxygen vacancies and the growth of both acidic and basic centers. Ca/Ba increase the CO conversion rate and ethylene-propylene selectivity of Fischer-Tropsch reaction, while decreases the production of methane. Correlations between the acid-base and catalytic properties of the doped samples were found. The introduction of Ca/Ba into the ferrite lattice leads to an increase in the activation energies of methane formation for all samples except gadolinium ferrite with 1%Ca (26 kJ/mol). The minimum value of the activation energy of ethylene formation was obtained for gadolinium ferrite with 1%Ca (44 kJ/mol). Compared to GdFeO<sub>3</sub>, an increase in the apparent activation energies of ethylene formation is observed for all other samples.

The involvement of CO<sub>2</sub> in the hydrogenation process led to a decrease in methane production for all catalysts, except for Gd<sub>0,99</sub>Ca<sub>0,01</sub>FeO<sub>3</sub>. A similar trend was also observed for the activation energy of ethylene production. For all samples studied, an increase in the amount of CO<sub>2</sub> added to the reaction mixture led to a suppression of methane production and an increase in selectivity for olefins. Under Fischer-Tropsch synthesis conditions, surface carbonates are formed on Gd atoms (A-site of the perovskite structure), and atomic radicals of hydrogen and CH<sub>x</sub> are formed on Fe (B-site) atoms [4]. The CO<sub>2</sub> molecule can be initially reduced to CO by H<sub>2</sub> via RWGS at the Gd sites, followed by hydrogenation of CO to olefins via the FTO reaction at the Fe sites.

All the studied ferrite samples showed high stability. The catalytic characteristics did not change after 50 hours of process and remained stable during repeated experiments.

### References

- [1] Energy Institut. Statistical Review o of World Energy **2023**. ©Energy Institute 2023  
 [2] Industry Paper on Petrochemical Industry **2020** <https://www.walkwatertalent.com/wp-content/uploads/2020/01/Industry-Paper-Petrochemicals-Industry.pdf>  
 [3] C.G. Visconti, M. Cartinelli, L. Falbo, et al. // Appl. Catal. B **2017**, 200, 530–542  
 [4] T. F. Sheshko, E. M. Borodina, L. V. Yafarova, E. B. Markova, T. A. Kryuchkova, A. G. Cherednichenko, I. A. Zvereva and A. O. Terent'ev // Catalysts.13 **2023**, 1256  
<https://doi.org/10.3390/catal13091256>;

### Acknowledgements

This work was supported by the Russian Science Foundation (grant № 24-29-00341, <https://rscf.ru/project/24-29-00341>)



## SYNTHESIS AND INVESTIGATION OF THE PROPERTIES OF NEW PHASES

*Astakhov N.V.*<sup>1</sup>, *Berdonosov P.S.*<sup>1</sup><sup>1</sup> Moscow State University, Moscow, Russia

Student

[nickavit@yandex.ru](mailto:nickavit@yandex.ru)

Low-dimensional magnetic systems with magnetically active ions anisotropically distributed in the crystal structure can form various types of groupings: isolated dimers, trimers, etc. (zero-dimensional magnets), chains, ladders (one-dimensional), as well as layers of various topologies (two-dimensional) [1]. The low-dimensional magnetic subsystem often leads to the fact that in such phases exotic basic quantum states may be observed, e.g. spin liquid, spin glass and spin ice, spin frustrations and others. This explains the increased interest in search for new low-dimensional magnets: firstly, the study of their quantum states is important for the fundamental foundations of condensed matter physics, and secondly, the relationship between low-dimensional magnetism and other quantum cooperative phenomena such as superconductivity and the behavior of supercooled gases has been noted, which has the potential for application in quantum measuring [2]. There are also ideas that on the basis of one-dimensional magnetic materials, it is possible to create materials with controlled heat transfer [3].

But there is no systematic search for such phases. The synthesis of phases with low-dimensional magnetism is one of the hot topics in modern material science. From this point of view, the class of transition metal chalcogenides is of interest. Due to the fact that the selenite or tellurite groups of  $\text{XO}_3^{2-}$  has a stereochemically active pair of electrons, their structures often reveal voids, channels or layers. The tendency to form such "loose" structures can be enhanced by introducing ions with small coordination numbers, in particular halides, into the composition. Among the selenite halides, a rather large family of phases with general composition  $A_2B(\text{SeO}_3)_2\text{Cl}_2$  ( $A = \text{Pb}, \text{Sr}, \text{Ba}$ ,  $B = \text{d-metal}$ ) and mineral sarrabusite  $\text{Pb}_5\text{Cu}(\text{SeO}_3)_4\text{Cl}_4$  [4] seems to be attractive. The aim of this work is to search for and synthesize phases from this family  $\text{Sr}_2\text{Mn}(\text{SeO}_3)_2\text{Cl}_2$ ,  $\text{Ba}_2\text{B}(\text{SeO}_3)_2\text{Cl}_2$  ( $B = \text{Ni}, \text{Cu}$ ),  $\text{Pb}_2\text{Cu}(\text{SeO}_3)_2\text{Cl}_2$ ,  $A_5B(\text{SeO}_3)_4\text{Cl}_4$  ( $A = \text{Pb}, \text{Sr}, \text{Ba}$ ,  $B = \text{Mn}, \text{Co}, \text{Ni}, \text{Cu}$ ), as well as the study of their physical properties.

The samples were synthesized using the solid-phase reactions in sealed silica tubes. Alkaline earth metal selenites  $A\text{SeO}_3$  and anhydrous d-metal chlorides  $B\text{Cl}_2$  were used as starting materials. In the case of lead compounds,  $\text{PbO}$ ,  $\text{SeO}_2$  and  $\text{CuCl}_2$  were chosen. Reactions was carried out at different temperatures. The purity of the samples was checked by powder X-ray diffraction (XRD).

Optimal conditions were found for sample preparation, depending on their composition. Crystal structures of new compounds were determined by powder of single crystal XRD. It was established that new compounds show different structural types. The IR spectra of the samples indicate the presence of a selenite groups in the structures, as well as the presence of Me-O-Se oscillations. For  $\text{Pb}_2\text{Cu}(\text{SeO}_3)_2\text{Cl}_2$  the structure was determined on a single-crystal XRD experiment. Unlike  $\text{Sr}_2\text{Cu}(\text{SeO}_3)_2\text{Cl}_2$ , in the structure of the new lead phase, the lead polyhedra are strongly distorted, presumably due to the presence of  $6s^2$  lone electron pair. Thermal analysis showed that  $\text{Sr}_2\text{Mn}(\text{SeO}_3)_2\text{Cl}_2$  is stable up to  $500^\circ\text{C}$ ,  $\text{Ba}_2\text{Cu}(\text{SeO}_3)_2\text{Cl}_2$  – up to  $550^\circ\text{C}$ ,  $\text{Ba}_2\text{Ni}(\text{SeO}_3)_2\text{Cl}_2$  – up to  $640^\circ\text{C}$ , and  $\text{Pb}_2\text{Cu}(\text{SeO}_3)_2\text{Cl}_2$  – up to  $530^\circ\text{C}$ . Primary measuring of magnetic properties for  $\text{Sr}_2\text{Mn}(\text{SeO}_3)_2\text{Cl}_2$  confirms the presence of a low-dimensional magnetic subsystem in the structure. At a temperature of  $T_N = 3.01\text{ K}$ , the substance undergoes antiferromagnetic ordering, which is also observed in the temperature dependence of heat capacity. The structural parameters of the new phases and related ones are compared in the presented study.

## References

- [1] *npj Quant Mater*, **2018**,3(18)
- [2] *Nature*. **2021**. Vol. 598,7880. 287-292
- [3] *Eur. Phys. J. Spec. Top.*, **2007**, 151, 73–83.
- [4] *Acta Cryst*. **2012**, B68, 15-23

## CATALYTIC CONVERSION OF CARBON MONOXIDE INTO CARBON DIOXIDE IN THE PRESENCE OF COBALT FERRITE SPINELS

*Azimova G.R.<sup>1</sup>, Babayev E.M.<sup>1,2</sup>*

<sup>1</sup> Catalysis and Inorganic Chemistry Institute, Baku, Azerbaijan

<sup>2</sup> Azerbaijan State Oil and Industry University, Baku, Azerbaijan

PhD Student

[ezimova2015@gmail.com](mailto:ezimova2015@gmail.com)

Recently, prevention of atmospheric pollution from gaseous pollutants establishes great problems for chemists. The present study is aimed at providing measures to ensure protection of the atmosphere from automobile exhaust pollution due to carbon monoxide and for it are used some ferrosinell catalysts. The catalytic efficiencies of ferrite materials have been tested at various temperatures for the oxidative removal of carbon monoxide (CO). Carbon monoxide is an extremely poisonous gas. Therefore, catalytic oxidation of carbon monoxide is one of the most important processes. It is mentioned that ferrite materials are cheaper compared to the platinum group metals [1].

As known,  $\text{CoFe}_2\text{O}_4$  is an interesting magnetic material and also, there are its high coercivity, moderate saturation magnetization, excellent chemical stability and mechanical hardness etc. The properties of ferrite nanoparticles are influenced by the composition and microstructure, which are sensitive to the preparation methodology used in their synthesis [2].

CO oxidation was carried out by the flow method at a  $\text{CO}:\text{O}_2 = 1: (0.4, 0.6, 0.8)$ , a space velocity of  $6000\text{-}12000 \text{ h}^{-1}$ . The analysis was carried out on an LKHM chromatograph, in two columns with CaA zeolite and poropak Q sorbents.

The catalytic activity of cobalt ferrite prepared by the sol-gel auto-combustion method with the ratio  $\text{Co-Fe} = 1:2$ ,  $\text{Co-Fe} = 1:1$  and  $\text{Co-Fe} = 2:1$  was investigated in the oxidation of carbon monoxide to dioxide. The temperature dependences of CO conversion for these cobalt ferrite samples are shown in Fig. 1. The results of CO oxidation on cobalt ferrite show that in the sol-gel method for producing ferrites affects the catalytic activity. The citric acid was used as an organic reagent. Figure 1 shows that all cobalt ferrite samples synthesized by sol-gel combustion method completely convert CO into  $\text{CO}_2$ .

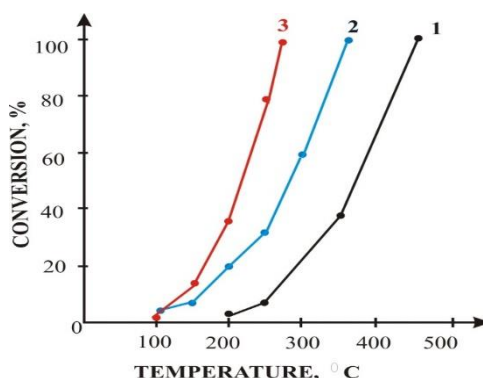

**Figure 1.** Dependence of CO conversion on temperature for cobalt ferrite samples obtained sol-gel method with combustion; 1) Co: Fe = 1:2, 2) Co: Fe = 1:1, 3) Co: Fe = 2:1.

Summarizing the above, we can conclude that in CO oxidation the influence of the ratio of cobalt and iron in ferrite on the catalytic activity of the synthesized samples was also studied. At hyperstoichiometric cobalt content  $\text{Co:Fe} = 2:1$  is sample. The most active cobalt ferrite sample ( $\text{Co-Fe}=2:1$ ) prepared by the sol-gel method with combustion. On these samples, the complete conversion of CO into  $\text{CO}_2$  occurs at a range temperature of  $200\text{-}250^\circ\text{C}$  and conversion reaches 100%.

### References

- [1] *Open J. Phys. Chem.* **2011**, 1, 124  
 [2] *Current Appl. Phys.* **2010**, 10, 284

## METAL-INVOLVING NONCOVALENT INTERACTIONS IN PLATINUM(II) DITHIOCARBAMATE COMPLEXES

Eliseeva A.A.<sup>1</sup>, Busygina A.A.<sup>1</sup>, Rozhkov A.V.<sup>1</sup>, Ivanov D.M.<sup>1</sup>, Bokach N.A.<sup>1</sup><sup>1</sup> St. Petersburg State University, St. Petersburg, Russia

PhD, Assistant Professor

[a.a.eliseeva@spbu.ru](mailto:a.a.eliseeva@spbu.ru)

In the past five years, the demand for square-planar  $d^8$ -metal complexes as sterically accessible sites involved in diverse noncovalent interactions (NCI) has increased dramatically. Despite their positive charges, these centers can function as  $d_z^2$ -orbital centered nucleophiles toward various  $\sigma$ - and  $\pi$ -hole donors. According to our previous experience a substantial increase of  $d_z^2$ -nucleophilicity can be achieved by employing strong electron-donating dithiocarbamate ligands [1-2]. Thus, Pt(II) dithiocarbamate complexes have been previously employed by us as multifunctional NCI acceptors: [Pt(S<sub>2</sub>CNEt<sub>2</sub>)<sub>2</sub>] was stacked with electron-deficient arenes via  $\{d_z^2\text{-Pt}^{\text{II}}\text{S}_4\} \cdots \pi$ -hole interactions [1], and also formed I $\cdots$ Pt<sup>II</sup> halogen bonds with perfluorinated iodoarenes [2].

These studies stimulated our further interest in relevant systems and for the continuation of our project we addressed Pt(II) dithiocarbamates bearing mixed chelating ligands – [Pt(PPy)(S<sub>2</sub>CN(CH<sub>2</sub>)<sub>n</sub>)] (PPy – 2-phenylpyridine; n = 4 (**1**), 6 (**2**)). The complexes **1** and **2** were co-crystallized with tellurides TePy<sup>F</sup><sub>2</sub> (Py<sup>F</sup> = C<sub>5</sub>F<sub>4</sub>N-4) and TeTol<sup>F</sup><sub>2</sub> (Tol<sup>F</sup> = C<sub>6</sub>F<sub>4</sub>CF<sub>3</sub>-4) to form cocrystals **1**·TePy<sup>F</sup><sub>2</sub>, **2**·TePy<sup>F</sup><sub>2</sub>, and **2**·TeTol<sup>F</sup><sub>2</sub>, whose structures were studied by single-crystal X-ray diffraction (XRD). In all three structures, we observed stacking interactions between the complexes and the tellurides, which involve a few types of NCI (Fig. 1). The stacking includes contacts between a metal center and Te and/or an arene of TeR<sup>EWG</sup><sub>2</sub>. In the cocrystals, several atoms exhibit NCI acceptor abilities: Pt center, S-atom of the dithiocarbamate ligand, and a C-atom of the ppy ligand are involved in chalcogen bond with Te; the phenyl ring of the ppy ligand, C-atom of the dithiocarbamate, Pt donate electron density to  $\pi$ -holes of the Py<sup>F</sup> (or Tol<sup>F</sup>) groups. The multiplicity of NCI centers in each of the cofomers leads to a diversity of the formed noncovalent contacts.

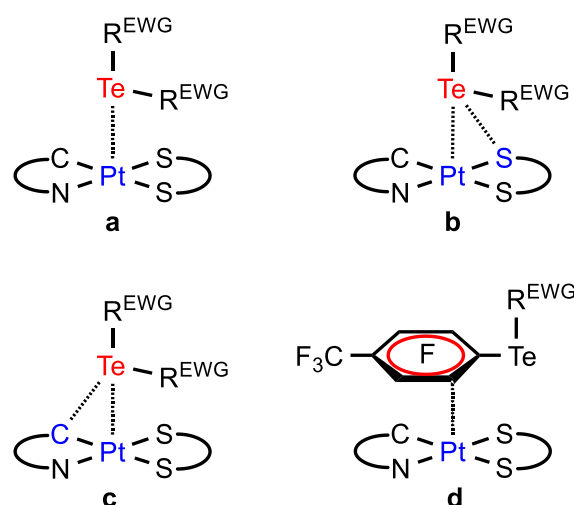

**Figure 1.** Identified metal-involving contacts.

Our DFT analysis using QTAIM, NCIPLOT, and NBO methods has elucidated the complex interplay of NCI within the cocrystals. These studies have highlighted the presence of significant chalcogen bonds, lone pair interactions, and  $\pi$ -stacking, all contributing to the stability of the dimeric assemblies. This research enhances our understanding of NCI and provides a foundation for the development of new materials leveraging these intricate chalcogen bond interactions.

## References

- [1] *Inorg. Chem. Front.* **2022**, 9, 2869  
 [2] *Inorg. Chem. Front.* **2021**, 8(10), 2505

## COBALT CATALYSTS FOR FISCHER-TROPSCH SYNTHESIS DEPOSITED ON CARBONIZED SPINEL

*Eliseev O.L.*<sup>1</sup>, *Chernavsky P.A.*<sup>1</sup>, *Kazantsev R.V.*<sup>1</sup>, *Eremina E.V.*<sup>2</sup>

<sup>1</sup> Institute of Organic Chemistry by named N.D. Zelinsky RAS, Moscow, Russia

<sup>2</sup> Gubkin Russian State University of Oil and Gas, Moscow, Russia

Student

[ereminaekaterina2002@mail.ru](mailto:ereminaekaterina2002@mail.ru)

Synthesis of hydrocarbons from CO and H<sub>2</sub> makes it possible to efficiently utilize resources of coal, natural and associated gas, biomass for production of motor fuels, base oils, petrochemical intermediates. Synthetic hydrocarbons are characterized by almost complete absence of sulfur- and nitrogen-containing impurities, aromatic compounds, and better environmental characteristics [1, 2]. For preparation of Fe and Co-catalysts for this process, oxide carriers with developed surface - alumina, silica gel, aluminosilicates - are usually used. However, their disadvantage is the strong metal-carrier interaction at the preparation stage, which leads to the formation of mixed oxides inactive in catalysis. We propose to carbonize the surface of the carrier (Mg-Al spinel) to reduce the cobalt-carrier interaction and to use the metal more efficiently.

Carbonization was carried out by impregnating the carrier with aqueous glucose solution followed by drying and calcination in nitrogen atmosphere. Cobalt in an amount of 10 wt.% was applied from nitrate solution by impregnation on the carrier with subsequent drying and calcination in nitrogen atmosphere. The catalysts are designated Co/xC/MA, where x is the mass fraction of carbon in the carrier. The carbon-free comparison sample is designated Co/MA.

Carbonization led to a significant increase in the specific surface area of the catalyst: from 14 for Co/MA to 103 m<sup>2</sup>/g for Co/40C/MA due to the formation of micro- and mesopores. The crystallite size of Co<sub>3</sub>O<sub>4</sub> according to XRD analysis decreased proportionally to the specific surface area.

X-ray phase analysis showed the presence of Co<sub>3</sub>O<sub>4</sub> phase (ICSD 98-002-4210) in all catalysts, and in addition, in the most carbonized samples Co/20C/MA and Co/40C/MA also Co(II) oxide (ICSD 98-024-5324). Obviously, the carbon of the substrate acts as a reducing agent for cobalt during calcination of the catalytic precursor.

The rate of cobalt reduction during high-temperature activation by hydrogen was determined by magnetization of the sample [3]. It increased in proportion to the amount of carbon in the sample: Co/40C/MA > Co/20C/MA >> Co/4C/MA ≈ Co/MA. Under standard activation conditions of Fischer-Tropsch synthesis catalysts (1 atm, H<sub>2</sub> current, 450°C), cobalt was completely reduced to metal in 2 hours.

Catalytic tests were carried out in a flow reactor under the following conditions: CO:H<sub>2</sub> = 1:2, P 2 MPa, T 210°C. Synthesis gas flow rate was regulated, maintaining CO conversion at the level of 9-11%. Carbonization had a positive effect on the catalyst selectivity for the target higher hydrocarbons: it increased from 85% for Co/MA to 89% for Co/40C/MA. The selectivities for methane were 6 and 4%, respectively. The maximum specific activity was shown by Co/4C/MA sample – 1004 μmol<sub>CO</sub> mol<sub>Co</sub><sup>-1</sup> s<sup>-1</sup>, for the others it was 750-900 μmol<sub>CO</sub> mol<sub>Co</sub><sup>-1</sup> s<sup>-1</sup>.

#### References

- [1] Martinelli M., Gnanamani M.K., Le Viness S., Jacobs G., Shafer W.D. // *Applied Catal. A, General*. 2020. V. 608. 117740.  
 [2] Eliseev O.L., Savost'yanov A.P., Sulima S.I., Lapidus A.L. // *Mendeleev Commun.* 2018. V. 28. P. 345.  
 [3] Chernavskii P.A., Pankina G.V., Kazantsev R.V., Kharlanov A.N., Panfilov S.A., Novakova A.A., Eliseev O.L. // *Catal. Lett.* 2023. V. 153. No 12. P. 3678/

SPIROBORATE COMPLEXES BASED ON BETA-DIKETONES AND BETA-KETOIMINES:  
SYNTHESIS AND LUMINESCENCE

Gromyko A.A.<sup>1,2</sup>, Tretyakova G.O.<sup>1,2</sup>, Mirochnik A.G.<sup>2</sup>, Fedorenko E.V.<sup>2</sup>

<sup>1</sup> Far Eastern Federal University, Vladivostok, Russia

<sup>2</sup> Far Eastern Branch of the Russian Academy of Sciences, Vladivostok, Russia

Student

[gromyko.aa@dvfu.ru](mailto:gromyko.aa@dvfu.ru)

Spiroborate complexes are compounds with four coordinated atoms, featuring two pi-planes oriented perpendicular to each other [1]. These compounds are of interest due to their potential use in solid-state phosphors for optoelectronic devices, fluorescent sensors, and biomedical imaging applications [1]. Spiroborates are also used in laser-active dyes, fluorescence sensing, and solid-state luminescent materials due to their impressive photophysical properties and chemical stability [1-3].

The aim of this study is to synthesize and investigate the spectral luminescence properties of spiroborate complexes based on beta-diketones and beta-ketoimines with malonic acid as a co-ligand.

The ketimine derivatives were prepared using solid-phase microwave synthesis, through the reaction of acetylacetone with ammonia and methylamine, respectively.

All spiroborate complexes were obtained through the reaction of the corresponding diketone or ketimine with malonic acid and boric acid. The reaction was conducted by heating and stirring in a Dean-Stark apparatus until the expected amount of water had been separated.

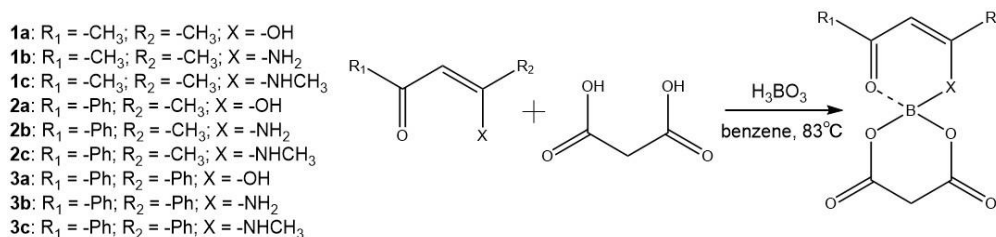

**Scheme 1.** The general scheme of synthesis of compounds **1a-3c**

As a result, nine new compounds were synthesized. The mass fraction of the products varied from 70% to 94%, with six compounds being synthesized for the very first time.

The molecular structures of the spiroborate complexes were calculated using quantum mechanical modeling techniques.

The spectral-luminescence properties of the compounds in dilute and concentrated solutions, as well as in the crystalline form, were investigated. It was found that there was a significant shift in the spectrum towards the longer wavelengths and an increase in luminescence intensity when going from solutions to crystals. This can be attributed to the reduction in intramolecular rotational freedom, which causes non-radiative transitions in the aggregated state.

### References

- [1] *Dyes and Pigments* **2021**, 193, 109538.  
 [2] *J. Org. Chem.* **2022**, 960, 122228.  
 [3] *J. Org. Chem.* **2021**, 24, 18030.

### Acknowledgements

This work was supported by the Russian Science Foundation (project No 23-23-00463).

## SEPARATION OF ZIRCONIUM AND URANIUM USING GALLIUM-BASED ALLOYS

*Ivanov A.B.<sup>1</sup>, Petrov D.S.<sup>1</sup>, Volkovich V.A.<sup>1</sup>, Smirnova V.V.<sup>1</sup>*

<sup>1</sup> Ural Federal University, Yekaterinburg, Russia  
[chivasch@yandex.ru](mailto:chivasch@yandex.ru)

Salt melts and metallic alloys exhibit high thermal and radiation stability. This makes them a promising working environment for the development of pyroelectrochemical methods for reprocessing spent nuclear fuel (SNF) and the practical implementation of a short closed nuclear fuel cycle. One of the important tasks of radiochemical technology is phase separation. The literature [1] contains data on the behavior of uranium in binary alloys with a number of low-melting metals. Low-melting metals can be effectively used for the selective extraction of spent fuel components in the liquid metal–molten salt system [2].

Uranium and zirconium have similar electrochemical properties. This fact makes the separation of these metals during pyroelectrochemical reprocessing of SNF a challenging task. There is no information about the Ga–Zr–U ternary phase diagram. Of the corresponding binary systems, only Ga–U alloys have been studied in detail [3].

In this study uranium and zirconium chlorides were dissolved in a melt of alkali metal chlorides. In this melt were crucibles containing molten gallium. The exposure time was 20 hours. Previously, this time was determined experimentally.

The separation coefficients of zirconium and uranium in the “molten salt – liquid metal” system for gallium and alloys based on the Ga were experimentally determined.

The working setup is shown in Figure 1.

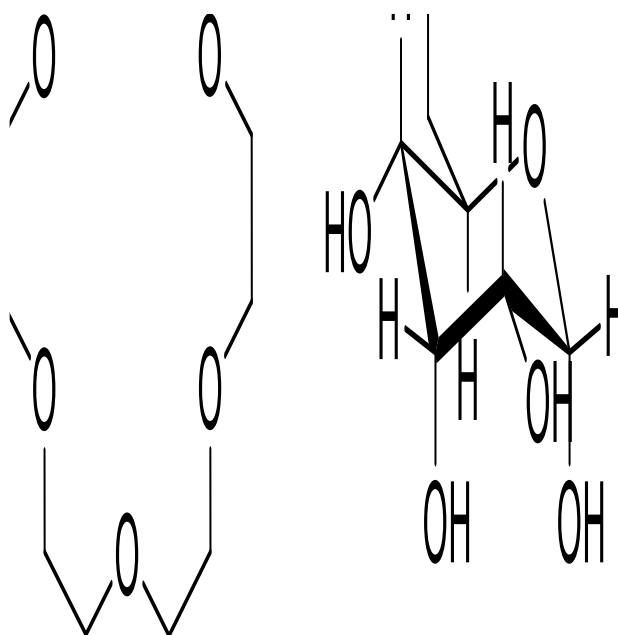

**Figure 1.** Figure one shows crucibles containing a melt of gallium and uranium metal. During the experiment, they are under molten NaCl-KCl-CsCl eutectic salt.

### References

- [1] *Metallurgiya* **1989**, 336
- [2] *Metallurgiya* **1993**, 232
- [3] *Rasplavy* **2006**, 4, 21–28

## COMPLEXATION OF 2,2'-BIBENZIMIDAZOLE WITH Co(II) IN AQUEOUS AND DIMETHYLFORMAMIDE

Ivanova S.R.<sup>1</sup>, Al Ansari Y.F.<sup>1</sup><sup>1</sup> Mari State University, Yoshkar-Ola, Russia

Student

[yana\\_ansari@mail.ru](mailto:yana_ansari@mail.ru)

Benzimidazoles and complexes are based on them have found their application in many fields of science and technology. The most important property of benzimidazoles is their biological activity, as a result of which highly effective drugs used in medicine, veterinary medicine and agriculture have been created on their basis.

A special place among benzimidazole's derivatives is occupied by 2,2'-bibenzimidazole (BBI, H<sub>2</sub>X), which is a recognized pharmacological agent with antiviral and antitumor effects. Complex compounds promote better and more complete absorption of drugs in the body.

In this regard, it is of interest to study the complexation of Co(II), which is a biometal, with 2,2'-bibenzimidazole.

The study was carried out in a dimethylformamide's (DMF) solution using spectrophotometric methods and in an aqueous solution using conductometric and potentiometric titration methods.

The electronic absorption spectrum of a solution of BBI in DMF contains two bands – at 325 and 340 nm. When a cobalt salt is added to the BBI solution, the spectrum changes - the band shifts hypsochromically to 325 nm, a hyperchromic effect is observed, and an unresolved band appears in the region of 355 nm, which was chosen for further research. These changes indicate the presence of complexation in the Co(II) – BBI – DMF system.

By spectrophotometric titration of mixture a Co(II) solution with a BBI in DMF, it was established that the coordination sphere of the complex includes two BBI molecules. The curve was processed using the Benesi-Hildebrand method. On the base of calculation we found out a stepwise formation of a bisligand complex through the stage of formation of a monoligand complex. Stability constants calculated:  $\lg\beta_1 = 4,70$ ;  $\lg\beta_2 = 10,00$ .

The molar ratio of complexing agent and ligand in complex particles formed in an aqueous medium was determined using the method of conductometric titration of an aqueous solution of Co(II) salt with a solution of BBI in DMF. The breaks in the curve (Fig. 1) correspond to the Co(II) : BBI ratios equal to 1:1, 1:2 and 1:3.

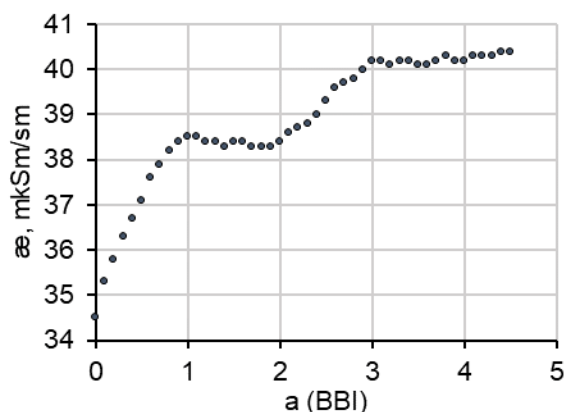

**Figure 1.** Conductometric titration curve of Co<sup>2+</sup> with BBI solution  $C_{Co(II)} = 1 \cdot 10^{-3}$  M,  $C_{BBI} = 0,01$  M

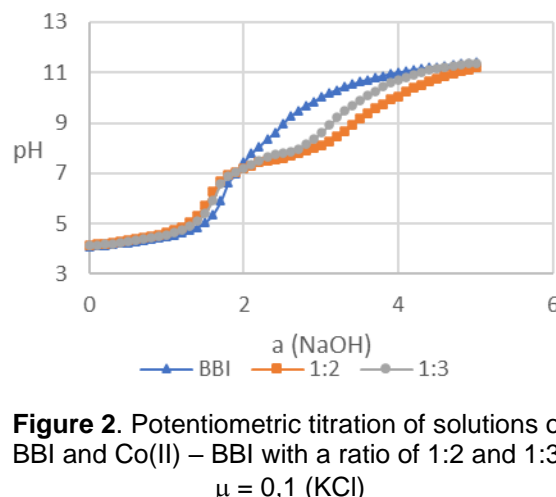

**Figure 2.** Potentiometric titration of solutions of BBI and Co(II) – BBI with a ratio of 1:2 and 1:3,  $\mu = 0,1$  (KCl)

Based on the results of potentiometric titration (Fig. 2), the stability constants of complex particles were calculated  $[Co(HX)_2]$  ( $\lg\beta = 10,76$ ),  $[CoX_2]^{2-}$  ( $\lg\beta = 12,18$ ),  $[Co(HX)_3]^-$  ( $\lg\beta = 14,98$ ).

Thus, the presence of the complexation process in an aqueous medium and in a DMF solution was proven. In the DMF medium, the formation of mono- and bis-ligand complex particles was revealed; in water, complexation proceeds until the formation of the Tris complex. The stability constants of complex compounds are calculated.

## IDENTIFYING SELECTIVELY ANTIMICROBIAL METAL AND METAL-OXIDE NANOPARTICLES FOR TARGETED ERADICATION OF PATHOGENIC BACTERIA

Jyakhwo Susan

ITMO University, Saint Petersburg, Russian Federation

2nd year PhD student

[jyakhwo@scamt-itmo.ru](mailto:jyakhwo@scamt-itmo.ru)

Microbial infections caused by bacteria, viruses, or fungi pose significant health risks, with antibiotics being the primary treatment. However, their non-selective nature and overuse contribute to antibiotic resistance [1]. Inorganic nanoparticles (NPs) offer a promising alternative due to their ability to combat infections by disrupting bacterial metabolism, damaging cell membranes, and inhibiting biofilm formation [2]. At the same time, size, shape, roughness, surface charge, and other specific properties of NPs facilitate varied interactions with bacteria compared to antibiotics which have a specific mechanism of action. This diversity in mechanisms of action of NPs poses challenges in developing a generalized theory to predict the antimicrobial effects across various bacterial strains [3]. The need becomes more pronounced when considering selectively toxic nanoparticles tailored to exert antimicrobial activity exclusively against pathogenic bacteria. These challenges spur investigations into developing theoretical models based on a data-driven approach, allowing correlation among poorly formalized parameters. Although machine learning has been used for predicting antimicrobial activity of NPs, overall, to our knowledge, no study has evaluated its capability to discover selectively antimicrobial NPs.

Our approach involved compiling comprehensive databases to characterize nanoparticles and their antibacterial activity. We trained CatBoost regressor model on unique datasets consisting of 489 samples for minimal concentration prediction. The ML model achieved a mean cross-validation  $R^2$  score of 0.82 with RMSE of 0.46 respectively. Subsequently, we combined ML with genetic algorithm (GA), a screening platform that enables high-throughput identification of NPs with selective antimicrobial activity. With this platform we for the first time identified CuO NPs exhibiting selective antimicrobial against pathogenic *Staphylococcus aureus*. CuO NP with key parameters including NP synthesis with green methods, nanorods in shape, average NP size of 30 nm, and reaction time of 2 hours showed a minimal bactericidal concentration (MBC) of 62.52  $\mu\text{g/ml}$  against *Staphylococcus aureus* whereas it achieved MBC of 455.37  $\mu\text{g/ml}$  for non-pathogenic *Bacillus subtilis*. Hence, the selectively antimicrobial CuO NP demonstrated higher toxicity against pathogenic *Staphylococcus aureus* compared to non-pathogenic *Bacillus subtilis*, with a concentration difference of 392.85  $\mu\text{g/ml}$ . The antimicrobial selectivity of NPs is attributed to a complex interaction between the NPs and diverse microbial strains. The findings of this study present a novel and promising methodology for identifying selectively antimicrobial NPs capable of eradicating pathogenic bacteria without harming non-pathogenic ones.

### Reference

- [1] Dadgostar, P. Antimicrobial Resistance: Implications and Costs. *Infect Drug Resist* 2019, 12, 3903.  
[2] Ramadan, Y. F. ; N. ; Al-Harbi, A. I. ; A.; Ahmed, E. ; Battah, A.; Ellah, N. H. ; Zanetti, S. ; Hetta, H. F.; Donadu, M. G. Nanotechnology as a Promising Approach to Combat Multidrug Resistant Bacteria: A Comprehensive Review and Future Perspectives. *Biomedicines* 2023, Vol. 11, Page 413 2023, 11 (2), 413.  
[3] Amaro, F.; Morón, Á.; Díaz, S.; Martín-González, A.; Gutiérrez, J. C. Metallic Nanoparticles—Friends or Foes in the Battle against Antibiotic-Resistant Bacteria? *Microorganisms* 2021, 9 (2), 1–11.

### Acknowledgements

This work was supported by the Russian Science Foundation (project No 21-73-10150).



## WATER-SOLUBLE FORMS OF THERANOSTICS BASED ON BIS(BODIPY) AND PLURONIC® F127

*Kalinkina V.A.,<sup>1,2</sup> Antina L.A.,<sup>1</sup> Kalygin A.A.<sup>1</sup>*<sup>1</sup> Institute of solution chemistry of the Russian academy of sciences, Ivanovo, Russia<sup>2</sup> Ivanovo State University of chemistry and technology, Ivanovo, Russia

Student

[valekalinkina@yandex.ru](mailto:valekalinkina@yandex.ru)

The proliferation of oncologic diseases requires the development of new complex approaches, including both early diagnosis and effective treatment, based on the use of bifunctional compounds - theranostics. The bis(BODIPY) luminophores with the properties of fluorescent biomarkers and photosensitizers necessary for promising theranostics in cancer treatment can be referred to such compounds. The problem of practical usage of the most BODIPY luminophores is related to their extremely high hydrophobicity. We have obtained the first water-soluble forms of bis(BODIPY) luminophores by encapsulating the luminophores in nanoscale micelles of the biocompatible amphiphilic block copolymer Pluronic® F127.

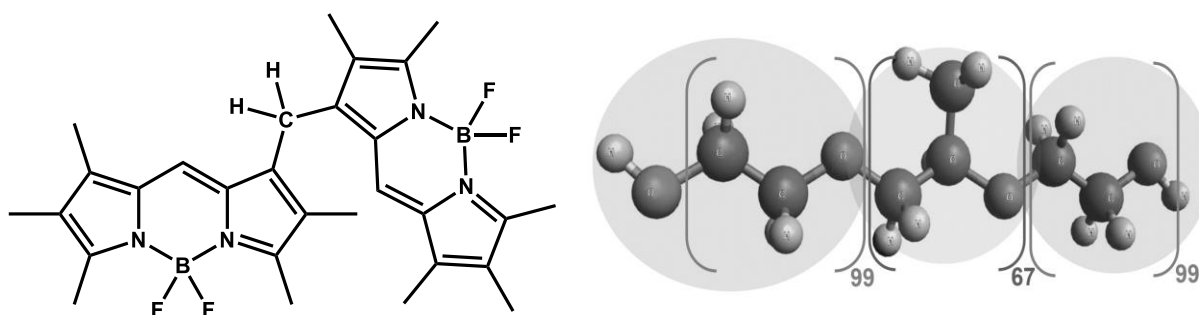

**Scheme 1.** Structure of bis(BODIPY) and amphiphilic block copolymer Pluronic® F127

The analysis of methods of bis(BODIPY) encapsulation into Pluronic® F127 (PI) micelles showed that the "thin films" method gives the highest solubilization efficiency at low polymer content (CPI = 5.25 mM). The bis(BODIPY)@PI micellar structures do not show cytotoxicity and do not affect platelet aggregation when subjected to adenosine diphosphate. Analysis of the effect of micelles on cell line survival showed no cytotoxicity, while cancer line survival was reduced by 2-fold or more after irradiation. Further in-vitro and in-vivo studies will be aimed at evaluating the prospects of practical application of bis(BODIPY)@PI theranostics.

The study was funded by the Russian Science Foundation grant No. 23-23-00206

#### Acknowledgements

This work was supported by the Russian Science Foundation (project No 23-23-00206).

## PHYSICO-CHEMICAL STUDY OF THE COMPOSITION AND PROPERTIES OF DUNE SANDS

*Khokimov A.E.*<sup>1</sup>, *Eminov A.M.*<sup>2</sup>, *Kadirova Z.R.*<sup>3</sup>, *Eminov Sh.O.*<sup>1</sup>

<sup>1</sup>Fergana polytechnic institute, Fergana, Uzbekistan

<sup>2</sup>Yangiyer branch of Tashkent Institute of Chemical Technology, Yangiyer, Uzbekistan

<sup>3</sup>Institute of General and Inorganic Chemistry, Academy of Sciences of the Republic of Uzbekistan  
PhD student

[25abdulaziz1995@gmail.com](mailto:25abdulaziz1995@gmail.com)

Uzbekistan is determined to meet its national economic demand for building materials, particularly ceramic materials. Achieving this goal entails ramping up production and expanding the raw materials base. Non-metallic minerals, notably rocks, are pivotal resources for the ceramic and construction industries within the country's chemical technology landscape. Uzbekistan possesses a wealth of accessible and promising raw materials, including various high-silica rocks, which are vital for the development and production of ceramic compositions [1,2].

To address this imperative, there is an urgent need to explore optimal compositions for ceramic bodies tailored for tile production, leveraging unconventional raw materials such as dune sands from the Yazyavan deposit. Concurrently, it's crucial to investigate the high-temperature sintering processes that occur during firing. Throughout this research endeavor, a range of raw materials, focusing on utilizing Uzbekistan's indigenous resources, and their chemical compositions have been thoroughly examined (Table 1).

**Table 1.** Dune sands of Yazyavan Chemical Composition

Sample	Weight content of oxides, %										
	SiO <sub>2</sub>	Al <sub>2</sub> O <sub>3</sub>	Fe <sub>3</sub> O <sub>4</sub> *	TiO <sub>2</sub>	P <sub>2</sub> O <sub>5</sub>	CaO	MgO	SO <sub>3</sub>	Na <sub>2</sub> O	K <sub>2</sub> O	LOI**
Precinct 4	62.16	7.14	3.40	0.35	0.29	7.10	4.05	0.30	1.85	2.01	10.86
Precinct 5	42.24	7.42	2.05	0.38	0.08	18.99	3.42	0.10	2.95	3.15	18.51

\*Fe<sub>3</sub>O<sub>4</sub> = FeO + Fe<sub>2</sub>O<sub>3</sub>. \*\*Loss on ignition (LOI) includes: hygroscopic water H<sub>2</sub>O, water of crystallization, organic and volatile impurities, and CO<sub>2</sub>.

The dune sands of Yazyavan, situated in the Fergana region, encompasses dune sands characterized by sandy rocks varying in colour from light to dark gray. These sands exhibit a poly-fractional composition, with particle sizes ranging between 0.10 and 0.52 mm.

**Figure 1.** X-ray diffractogram of dune sands of Yazyavan

Thereafter, the parameters of crystal structures of the dune sands were determined according to the x-ray method, on a wide-angle XRD-6100 "Shimadzu" (Kyoto, Japan) X-ray diffractometer, monochromated Cu-K<sub>α</sub> was used as a radiation source (Hebbel mirrors, U=40 kV, I=30 mA and scanning speed of 2 deg/min). In calculations and identification of crystalline x-ray diffraction phases, generally accepted reference data were used [3].

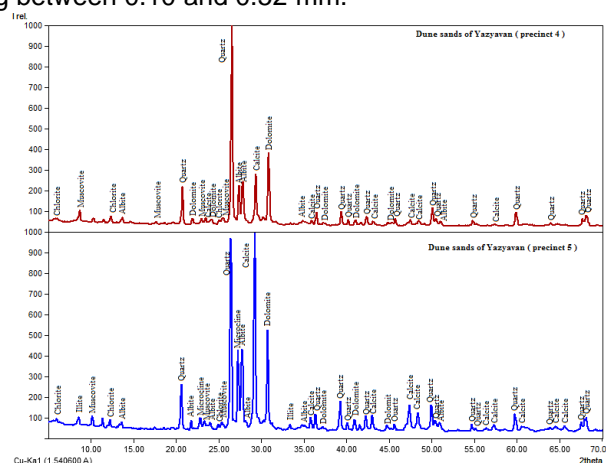

X-ray diffraction analysis (Figure 1) of the dune sands reveals distinct diffraction lines corresponding to various minerals present within the sample. Notably, diffraction patterns indicate the presence of quartz, calcite, dolomite, muscovite, illite, chlorite, albite, microcline. These findings shed light on the mineralogical composition of the dune sands of Yazyavan, providing valuable insights for further research and industrial applications.

## References

- [1] A.M.Ergeshov and L.I.Fimushkin, *Geological and Economic Monitoring of the Status and Utilization of the Mineral Resource Base of Non-metallic Raw Materials of Uzbekistan*, Tashkent (2005).
- [2] Sabirov, B.T., Kadirova, Z.R. & Tairov, S.S. *Development of Optimal Compositions of Ceramic Tiles Using Dune Sand*. *Glass Ceram* 75, 363–365 (2019). <https://doi.org/10.1007/s10717-019-00085-7>
- [3] C. F. Holder and R. E. Schaak, "Tutorial on powder x-ray diffraction for characterizing nanoscale materials," *Am. Chem. Soc.*, 7359 – 7365 (2019). <https://doi.org/10.1021/acsnano.9b05157>

SYNTHESIS OF LAYERED Gd-Eu AND Y-Eu HYDROXIDES AND STUDY OF FLUORESCENT PROPERTIES OF ORGAN-INORGANIC COMPOSITES BASED ON THEM

*Kosykh A.S.<sup>1</sup>, Rychkov V.N.<sup>1</sup>*

<sup>1</sup>Ural Federal University, Yekaterinburg, Russia

Postgraduate

[kosykhastasiya@yandex.ru](mailto:kosykhastasiya@yandex.ru)

Layered REE hydroxides (LRH) are known as excellent precursors of promising luminescent materials, which, in particular, are capable of converting UV radiation into radiation in the visible region of the spectrum [1,2]. Replacing anions in the interlayer space with organic ions of various compositions leads to a significant increase in the efficiency of conversion of radiation due to the sensitization effect. One of the important directions in the study of hybrid organic-inorganic materials based on LRH is to determine the influence of synthesis conditions and composition on their properties. In this work, Layered hydroxides of Gd-Eu and Y-Eu, as well as hybrid composites were obtained by intercalating terephthalate, salicylate and benzoate anions into a layered structure. To study the effect of processing temperature on the properties of hybrid composites, they were processed at 40, 100, 150, 250 and 400 °C.

The method of controlled double-jet precipitation was used, followed by the stages of filtration, washing and drying at 40 °C to synthesize LRH [3]. The precursors were collective solutions of Gd<sup>3+</sup> and Eu<sup>3+</sup>, Y<sup>3+</sup> and Eu<sup>3+</sup> nitrates with a mole fraction ratio of Gd:Eu and Y:Eu = 0.95:0.05. The obtained LRH samples were assigned the codes GdEu and YEu. To synthesize hybrid composites, GdEu and YEu powders were processed in aqueous solutions of sodium salts of organic acids Na<sub>m</sub>A, where A<sup>m-</sup> is the anion of terephthalate, salicylate or benzoate. Treatment was carried out at 90 °C for 6 h to intensify the ion exchange process. Then followed the stages of filtration, washing and drying at 40, 100, 150, 250 and 400 °C. The obtained samples of hybrid composites were assigned LRH codes, supplemented by the designation of the organic ion (TA, SA, BA) and heat treatment temperature, for example, GdEuTA-40.

The results of studying the phase composition of GdEu and YEu samples dried at 40 °C indicate the synthesis of layered structures, which were identified as layered hydroxide Gd<sub>2</sub>(OH)<sub>5</sub>NO<sub>3</sub>·nH<sub>2</sub>O due to the presence of corresponding 00l reflections. After hydrothermal treatment, the position of these diffractions changed towards lower angles, which indicates the introduction of large A<sup>m-</sup> anions into the interlayer space instead of NO<sub>3</sub><sup>-</sup> [4]. The conclusion about the successful intercalation of organic guests into the host layers was confirmed by observing the optical properties of powder hybrid composites, also dried at 40 °C: a red glow was detected – at 254 nm for samples GdEuTA, GdEuBA, YEuTA and YEuBA, at 365 nm for GdEuSA when exposed to UV radiation from a portable source. It is worth noting that the samples obtained by TA<sup>2-</sup> intercalation have the brightest luminosity. Based on a comparison of visual luminosity, organic sensitizers can be ranked in the sensitizing effect series as follows: TA<sup>2-</sup> > BA<sup>-</sup> > SA<sup>-</sup>. Results of a study of the excitation spectra of hybrid composites at λ<sub>em</sub> = 538 nm (transition <sup>5</sup>D<sub>0</sub> → <sup>7</sup>F<sub>2</sub> of Eu<sup>3+</sup>) and radiation at wavelengths λ<sub>exc</sub>, corresponding to the absorption maxima of the composites, confirmed and supplemented the conclusions made on the basis of visual analysis.

The study of the phase composition of samples of hybrid composites heat-treated at 40, 100, 150, 250 and 400 °C indicates a gradual destruction of the ordered structure of the layers. Hybrid composites can be arranged in the following order as the rate of destruction increases depending on the intercalated organic ion: SA<sup>-</sup> > BA<sup>-</sup> > TA<sup>2-</sup>. It was found that heat treatment also affects the fluorescent properties of powders. GdEuTA samples have visible luminosity after heat treatment at 250-400 °C, GdEuBA – after 40-400 °C, and GdEuSA – practically none. In this case, the most intense radiation upon excitation with UV wavelength of 254 nm is observed for the hybrid composites GdEuTA-250, GdEuTA-400 and GdEuBA-250, and at 365 nm – for GdEuTA-400. Similar patterns can presumably be found for hybrid composites based on YEu.

### References

- [1] *Cham: Springer* **2015**, 242
- [2] *Russ. Chem. Rev.* **2020**, 89(6), 629-666.
- [3] *Ceram. Int.* **2021**, 47, 2725-2734.
- [4] *J. Phys. Chem. C* **2014**, 118, 14511–14520.

### Acknowledgements

This work was carried out with the support of the Council for Grants of the President of the Russian Federation CP-2022. Photoluminescence spectroscopy measurements were carried out using the laboratory "Hybrid Technologies and Metamaterials", Institute of Physics and Technology, Ural Federal University.

## MAGNETIC PROPERTIES CHARACTERIZATION OF CROMIUM SUBSTITUTED STRONTIUM M-TYPE HEXAGONAL FERRITES

*Kovalev A.I.<sup>1</sup>, Zykova A.R.<sup>1</sup>, Sherstyuk D.P.<sup>1</sup>, Zhivulin V.E.<sup>1</sup>, Vinnik D.A.<sup>1,2,3</sup>*

<sup>1</sup> South Ural State University, Chelyabinsk, Russia

<sup>2</sup> St. Petersburg State University, St. Petersburg, Russia

<sup>3</sup> Moscow Institute of Physics and Technology, Moscow, Russia

PhD student

[kovalev-andrey-i@mail.ru](mailto:kovalev-andrey-i@mail.ru)

M-type hexaferrites are a long-time well-known permanent magnets which are still mass-produced. Besides that, they also have other potential applications based on their magnetic and radiation absorbing properties, such as electro-magnetic interference shielding. Another application is a ferrite circulator, where hexaferrites could be inserted as a self-biased magnetic material. While in the construction of circulator material with a desired ferromagnetic resonance (FMR) line should be placed in an external magnetic field. However, if such material has its own magnetic field, then need in an external field disappears, which leads the design of a circulator to miniaturization. M-type hexaferrites have a great potential in that area by having high coercive force ( $H_c$ ), tunable FMR frequency. In addition, their high Curie point provides a wide temperature range for utilization, which complemented with their corrosive resistant. [1-2].

This work aims to investigate magnetic properties, such as  $H_c$ , saturation magnetization ( $M_s$ ) and remanent magnetization ( $M_r$ ) of Cr-doped strontium hexaferrites  $\text{SrCr}_x\text{Fe}_{(12-x)}\text{O}_{19}$  ( $x = 0-6$ ).

Studied samples were prepared through ceramic synthesis. The iron oxide  $\text{Fe}_2\text{O}_3$ , chromium oxide  $\text{Cr}_2\text{O}_3$ , and strontium carbonate  $\text{SrCO}_3$  were used as an initial components. Components were weighed at a stoichiometric ratio and grinded in an agate mortar. Grinded samples were pressed into tablets and calcinated for 5 hours at the temperature of  $1400^\circ\text{C}$ .

Single state of samples was verified via X-ray diffraction (XRD) analysis by comparing resulting XRD patterns of samples with the diffraction pattern of single-phase Sr hexaferrite (card in ICDD database №39-1433). All of the patterns are in good matching with each other, so obtained hexaferrites corresponds to single phase megnetoplumbite structure of Sr hexaferrite.

Magnetic measurements were performed on vibrating-sample magnetometer on Quantum Design PPMS VersaLab. The increasement of temperature forces  $H_c$  to grow for all Cr concentrations, except of  $x = 2.5$ , where it decreases. Ferrite with Cr concentration  $x = 0.5$  has the largest addition in  $H_c$ . the  $M_s$  and  $M_r$  values inversely depends on temperature (Fig. 1), however in undoped Sr hexaferrite ( $x = 0$ )  $M_r$  at room temperature has higher value than at 50K.

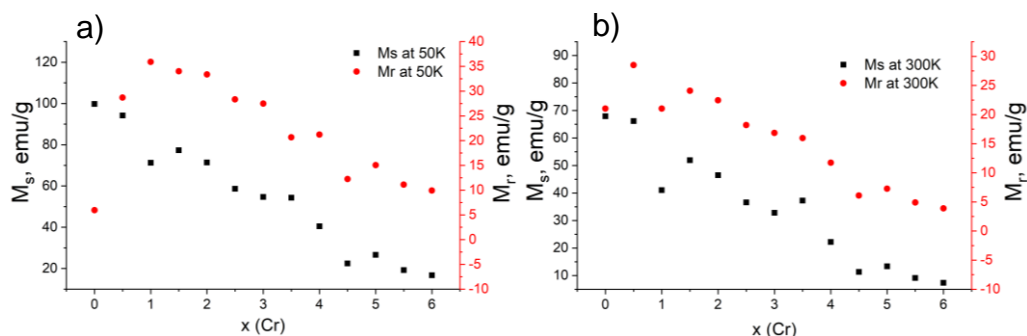

**Figure 1.** Dependencies on Cr concentration of a)  $M_s$  and  $M_r$ ; at 50K b)  $M_s$  and  $M_r$  at 300K

In conclusion, single-phase solid solutions of  $\text{SrCr}_x\text{Fe}_{(12-x)}\text{O}_{19}$  ( $x = 0-6$ ) were obtained by ceramic method. While with the increasement of temperature,  $H_c$  is growing, or in case of  $x = 2.5$  it's slightly decreases, the  $M_s$  and  $M_r$  values are inversely depends on temperature. A promising area for future research of Cr hexaferrites, would be measurement of FMR frequencies.

### References

- [1] *J. Eur. Ceram. Soc.* **2024**, 44, 936  
 [2] *iScience* **2023**, 26, 107077

### Acknowledgements

This work was supported by the Russian Science Foundation (project No 24-29-20187).

## SPECTROSCOPIC STUDY OF HYDROGEN BONDING IN COMPLEXES OF PHOSPHINE OXIDES WITH PHENOLS AND ALCOHOLS

Luhang Xu<sup>1</sup>, Mikhail A. Kostin<sup>2</sup>, Omar Alkhuder<sup>2</sup>, Danil V. Krutin<sup>2</sup>, Ruslan E. Asfin<sup>1</sup> and Peter M. Tolstoy<sup>2</sup>

<sup>1</sup>Department of Physics, St. Petersburg State University, Russia

<sup>2</sup>Institute of Chemistry, St. Petersburg State University, Russia  
Student

[st067893@student.spbu.ru](mailto:st067893@student.spbu.ru)

In this study, we employ both the PO (phosphorus-oxygen) and OH (hydroxyl) vibrational modes to assess the strength of OHO hydrogen bonds. We investigate three phosphine oxides—triphenylphosphine oxide, tributylphosphine oxide, and hexamethylphosphoramide—as proton acceptors. Our experimental IR analysis focuses on 30 complexes formed by these phosphine oxides with various substituted phenols or CF<sub>3</sub>CH<sub>2</sub>OH in CCl<sub>4</sub> solution at room temperature. We demonstrate that both the PO and OH vibrational frequencies exhibit non-linear changes upon hydrogen bond formation and strengthening. Moreover, we propose that the shifts of these vibrational bands could serve as valuable indicators for estimating hydrogen bond strength in complexes involving phosphine oxides. Additionally, we discuss the accuracy of these estimations and the influence of solvation effects on the primary characteristics of the complexes.

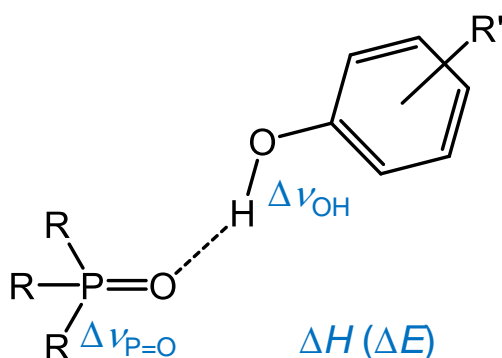

**Figure 1.** The general structure of complexes formed by phosphine oxides and substituted phenols.

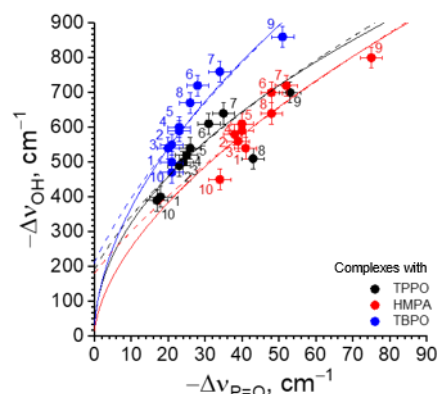

**Figure 2.** The correlations between  $-\Delta\nu_{\text{OH}}$  and  $-\Delta\nu_{\text{P=O}}$  based on IR

The correlation between  $\Delta\nu_{\text{P=O}}$  and  $\Delta\nu_{\text{OH}}$  could be described reasonably well by the power function

$$-\Delta\nu_{\text{OH}} = a \times (-\Delta\nu_{\text{P=O}})^b$$

### References

[1] *Phys.Chem.Chem.Phys.* **2024**, 26, 10234-10242

## RED PHOSPHORUS BIODEGRADATION BY STRAIN ASPERGILLUS

*Mindubaev A.Z.*<sup>1</sup>, *Babynin E.V.*<sup>3</sup>, *Galimova A.R.*<sup>4</sup>, *Gogolashvili E.L.*<sup>2</sup>, *Badeeva E.K.*<sup>2</sup>, *Minzanova S.T.*<sup>2</sup>.

<sup>1</sup> Kazan National Research Technological University.

<sup>2</sup> Budgetary-Funded Institution of Science A.E. Arbuzov Institute of Organic and Physical Chemistry of Kazan Scientific Center of Russian Academy of Sciences

<sup>3</sup> Tatar Research Institute of Agricultural Chemistry and Soil Science – Subdivision of the Federal Research Center “Kazan Scientific Center of Russian Academy of Sciences”.

<sup>4</sup> Kazan National Research Technical University named after A. N. Tupolev - KAI  
E-mail: [mindubaev-az@yandex.ru](mailto:mindubaev-az@yandex.ru)

Earlier studies have shown the ability of microorganisms, mainly the black aspergillus fungi *Aspergillus niger*, to oxidize to harmless phosphate ions a substance of the first hazard class white phosphorus. Red phosphorus is much less toxic, but more thermodynamically stable, and this makes it difficult to metabolize enzymatically. Nevertheless, more recent studies have shown that red phosphorus serves as a source of a nutrient for the same fungi that neutralize white phosphorus. The descriptions of the experiments, however, were mostly qualitative in nature. Quantification of biodegradation is essential, and the present work shows the first quantitative data on the biodegradation of red phosphorus by *A. niger* F-4815D. These data indicate a significant increase in the rate of red phosphorus oxidation, expressed through the accumulation of phosphate ions, the final product of oxidation, under the influence of the metabolism of *Aspergillus* growing in culture medium. Compared with the control, sterile medium containing red phosphorus, the rate increases by a factor of 1.25. The difference is insignificant, but reliable and appearing in each repetition of the experiment. We can assume that this difference would have been even higher. But the red phosphorus under study turned out to be originally contaminated with phosphoric acid. Probably it oxidized during storage. Because *Aspergillus* originally grew in phosphate-enriched medium, the activity of the red phosphorus biodegradation process was reduced compared to what was theoretically possible. Nevertheless, the presented work is the first documented study confirming red phosphorus biodegradation.



**Figure 1.** Growth of *Aspergillus niger* F-4815D in the presence of red phosphorus, 2 days after inoculation.

#### References

[1]. *Herald of Technological University*, 2023, 26, 10

NEW COPPER (II) SELENATES:  
SYNTHESIS, CRYSTAL STRUCTURE, PHYSICAL AND MAGNETIC PROPERTIES

*Pashkov G.A.*<sup>1</sup>, *Berdonosov P.S.*<sup>1</sup>, *Lyssenko K.A.*<sup>1,2</sup>, *Markina M.M.*<sup>1</sup>, *Vasiliev A.N.*<sup>1,3</sup>

<sup>1</sup> Moscow State University, Moscow, Russia

<sup>2</sup> G.V. Plekhanov Russian University of Economics, Moscow, Russia

<sup>3</sup> National University of Science and Technology "MISIS", Moscow, Russia  
Student

[grigorii.pashkov@chemistry.msu.ru](mailto:grigorii.pashkov@chemistry.msu.ru)

Low-dimensional (LD) magnetism is one of the most interesting and promising fields of current research in inorganic chemistry and condensed matter physics because of formation of exotic electronic states (e.g., spin glasses and liquids) due to the possible spin frustration. LD magnets-based materials are proposed as a new generation of electronic devices and spintronic application in perspective [1].

Copper (II) selenates  $\text{PbCuSeO}_4(\text{OH})_2$ ,  $\text{M}_2\text{CuSeO}_4\text{Cl}_2$  ( $\text{M} = \text{K}, \text{Rb}$ ) representing selenate analogues of natural minerals with LD magnetic behavior linarite  $\text{PbCuSO}_4(\text{OH})_2$  and chlorothionite  $\text{K}_2\text{CuSO}_4\text{Cl}_2$  correspondingly have been synthesized by the hydrothermal method for the first time. Their crystal structures have been determined by the single crystal XRD method [1-2]. The main goal of the study was investigation of the influence of structural changes (e.g., replacement  $\text{SO}_4^{2-} \rightarrow \text{SeO}_4^{2-}$  or  $\text{K}^+ \rightarrow \text{Rb}^+$ ) on the magnetic properties.

Selenate linarite  $\text{PbCuSeO}_4(\text{OH})_2$  turns out to be isostructural to  $\text{PbCuSO}_4(\text{OH})_2$ . Both compounds contain chains of edge-sharing  $\text{CuO}_4$  corrugated squares (Scheme 1) with slightly different Cu-Cu distances and dihedral angle  $\alpha$  which affect magnetic interaction between copper ions. The new substance has been investigated in measurements of magnetic susceptibility, magnetization, heat capacity, dielectric permittivity. This quasi-one-dimensional compound evidences formation of a short-range correlation regime at ca. 8 K and experiences a long-range magnetic order at  $T_N = 4.3$  K likewise its sulfur prototype. Moreover, both chalcogenates are apparently multiferroic systems [1, 3].

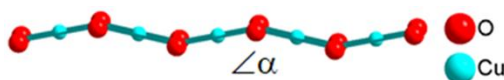

**Scheme 1.** Chains of  $\text{CuO}_4$  squares in  $\text{PbCuChO}_4(\text{OH})_2$ ,  $\text{Ch} = \text{S}, \text{Se}$ .

A different picture is observed in the case of selenate chlorothionites  $\text{M}_2\text{CuSeO}_4\text{Cl}_2$  ( $\text{M} = \text{K}, \text{Rb}$ ).  $\text{K}_2\text{CuSeO}_4\text{Cl}_2$  proves to be isostructural to  $\text{K}_2\text{CuSO}_4\text{Cl}_2$  whereas  $\text{Rb}_2\text{CuSeO}_4\text{Cl}_2$  differs from its prototype although keeps main structural features like chains of  $\text{CuO}_2\text{Cl}_2$  trapezia (Scheme 2). Measurements of magnetic susceptibility, magnetization and heat capacity have showed that synthesized chalcogenates are paramagnets, so in this case structural changes turn out to be crucial for magnetic subsystem. EDX and IR spectra of the substances have been collected as well.

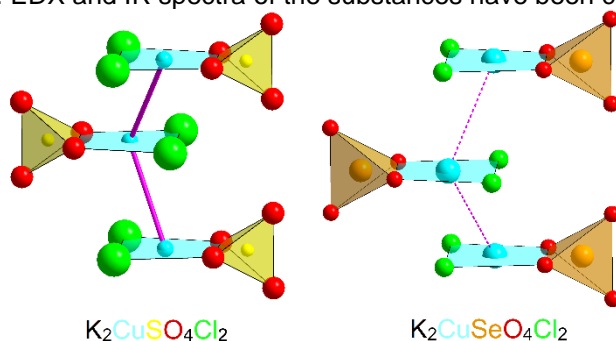

**Scheme 2.** Comparison of structural peculiarities of  $\text{K}_2\text{CuChO}_4\text{Cl}_2$ ,  $\text{Ch} = \text{S}, \text{Se}$ .

### References

- [1] *Mater. Chem. Phys.* **2024**, 319, 129367  
[2] *Materials.* **2022**, 15, 7860  
[3] *Phys. Rev. B.* **2016**, 94, 214409

### Acknowledgements

This work was supported by the Russian Science Foundation (project No 23-23-00205).

## SYNTHESIS AND MOLECULAR DOCKING STUDIES OF THE NICKEL(II) CHELATES WITH CYCLOHEXYL CONTAINING SCHIFF BASES

Panova E.V.<sup>1</sup>, Safin D.A.<sup>1</sup><sup>1</sup> University of Tyumen, Volodarskogo Str. 6, 625003 Tyumen, Russia

Postgraduate student

[elizaveta.v.panova99@gmail.com](mailto:elizaveta.v.panova99@gmail.com)

In this work, two nickel(II) coordination compounds, [Ni(L<sup>I</sup>)<sub>2</sub>] (**1**) and [Ni(L<sup>II</sup>)<sub>2</sub>] (**2**) (HL<sup>I</sup> = N-cyclohexyl-3-methoxysalicylideneimine; HL<sup>II</sup> = N-cyclohexyl-3-ethoxysalicylideneimine), were obtained from a one-pot synthetic procedure by reacting cyclohexylamine, 3-methoxy- or 3-ethoxysalicylaldehyde and Ni(OAc)<sub>2</sub> in EtOH (Scheme 1) [1]. The final products were obtained as single crystals suitable for single-crystal X-ray diffraction.

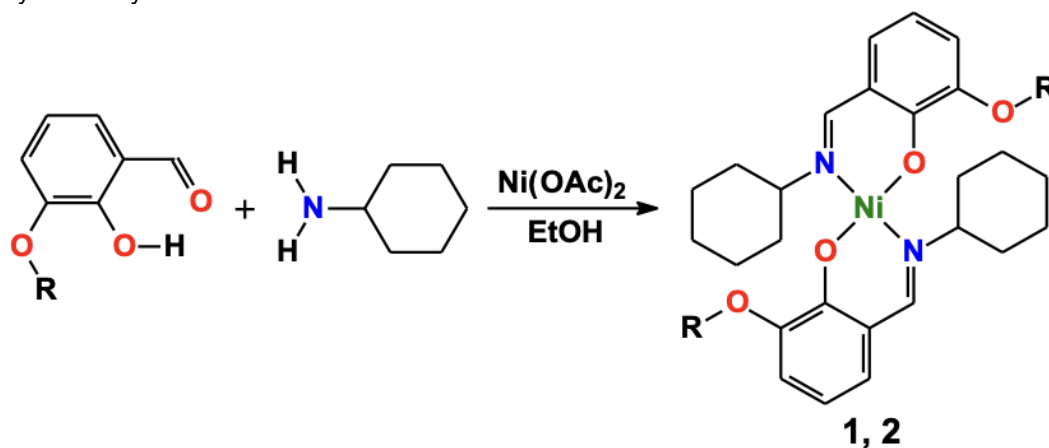

**Scheme 1.** Synthesis of the complexes (R = Me (**1**), Et (**2**)).

Both complexes were probed *in silico* as potential inhibitors of a series of the SARS-CoV-2 proteins using a molecular docking approach. It was established that both **1** and **2** can potentially inhibit of the applied proteins. The best results (−10.6 kcal/mol for **1** and −9.5 kcal/mol for **2**) were found for the Nonstructural protein 14 (N7-MTase) (Fig. 1). Thus, both complexes **1** and **2** are of interest as potential agents against COVID-19.

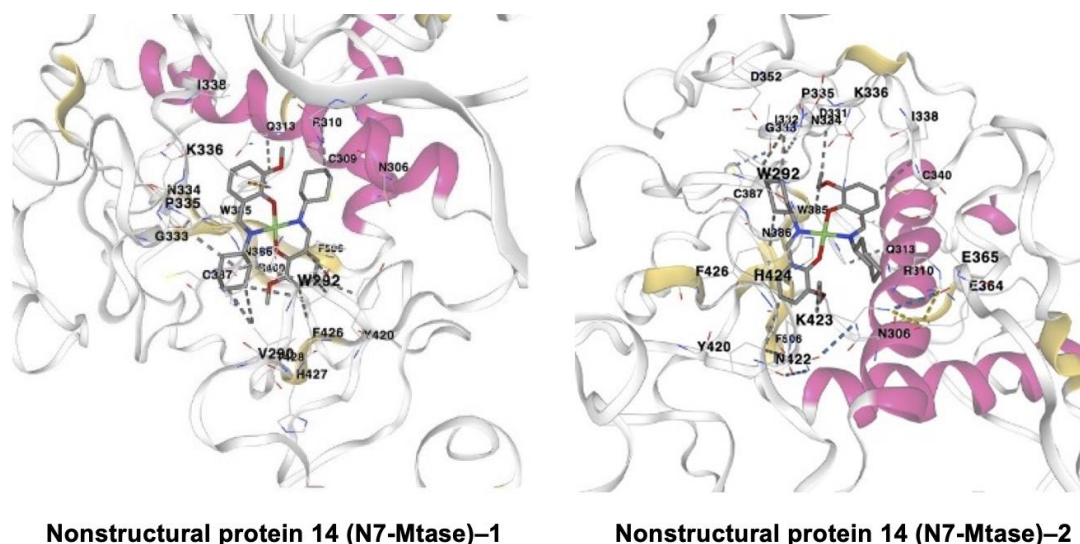

**Figure 1.** Intermolecular interactions in complexes of **1** and **2** with SARS-CoV-2 proteins with the best binding energies.

## References

[1] *Inorg. Chem. Commun.* **2024**, 162, 134066



SYNTHESIS AND INVESTIGATION OF HEXAFERRITE  $\text{BaFe}_{12-x}\text{In}_x\text{O}_{19}$  ( $X = 0.25-1$ )Punda A.<sup>1</sup>, Zhivulin V.E., Pavlova K.<sup>1</sup>, Gudkova S.<sup>1,2</sup>, Vinnik D.A.<sup>1,2,3</sup><sup>1</sup>South Ural State University, Chelyabinsk, Russia<sup>2</sup>St. Petersburg State University, St. Petersburg, Russia<sup>3</sup>Moscow Institute of Physics and Technology, Dolgoprudny, Russia

PhD student

[pundaai@susu.ru](mailto:pundaai@susu.ru)

This work describes the solid-state synthesis method and methods for studying the structure of barium hexaferrite doped with indium. Compared to iron ions, indium ions are larger, which can affect the crystalline lattice and magnetic properties of the resulting material. The iron substitution degree “x” was range from 0 to 1 with a step of 0.25. The structure analysis was conducted using the powder diffractometer Rigaku Ultima IV with X-ray phase analysis method. The results of electron microscopic analysis showed the production of monophasic samples. Magnetic permeability parameters were obtained using an E7-30 impedance meter.

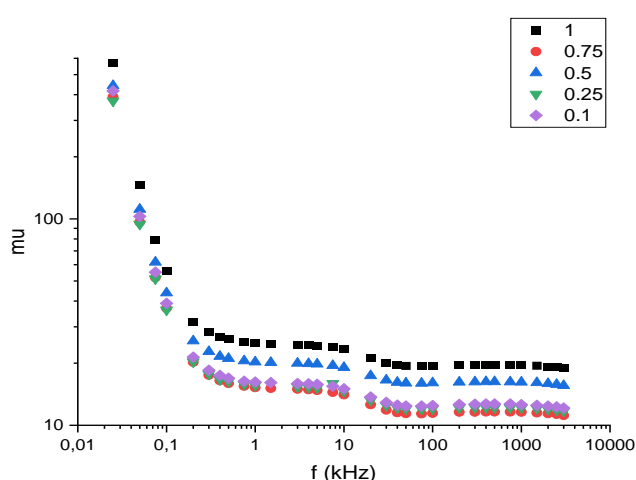

**Scheme 1.** Experimental magnetic permeability parameters for  $\text{BaFe}_{12-x}\text{In}_x\text{O}_{19}$  samples

The graph shows that as the indium content increases from sample to sample, the magnetic permeability decreases evenly, which indicates the influence of indium on the magnetic properties of the hexaferrite lattice. The resulting typical structure to the structure of pure barium hexaferrite. The crystal lattices were calculated (table). The volume increases with increasing substitution due to the larger ionic radius of  $\text{In}^{3+}$  ions compared to  $\text{Fe}^{3+}$  ions with the same coordination number, for example  $\text{CN} = 4$ ,  $r(\text{In}^{3+}) = 0.76 \text{ \AA}$ ;  $r(\text{Fe}^{3+}) = 0.63 \text{ \AA}$  [3]. Using the solid-state synthesis method, it is possible to select the degree of substitution of  $\text{BaFe}_{12-x}\text{In}_x\text{O}_{19}$  from x to 1 and control the indium content by varying the initial indium concentration in the mixture.

**Table 1.** Lattice parameters for  $\text{BaFe}_{12-x}\text{In}_x\text{O}_{19}$  samples

Lattice parameters	Iron substitution degree “x”					
	0 [1]	0 [2]	0.25	0.5	0.75	1
a(Å)	5.8945(5)	5.8929(4)	5.9035(2)	5.9177(4)	5.9266(19)	5.93213(18)
c(Å)	23.215(3)	23.1943	23.2652(12)	23.3384(16)	23.4171(9)	23.4402(10)
V(Å <sup>3</sup> )	698.5	697.54	702.19(5)	707.81(8)	712.32(4)	714.35(4)

## References

- [1] *Powder Diffraction*, **1988**, 3, 249  
 [2] *Physical Chemistry*, **2013**, 499, 39-40  
 [3] *Acta Crystallogr.*, 1679(A32), 751–767.

## Acknowledgements

The authors acknowledge Saint-Petersburg State University for a research project 124032600009-5.

## SYNTHESIS OF CARBON QUANTUM DOTS FROM UREA AND CITRIC ACID

*Rubanova D.S., Mamina M.S., Lipskikh M.V.*National Research Tomsk Polytechnic University,  
School of Earth sciences & Engineering, Tomsk, RussiaStudent  
[dsr12@tpu.ru](mailto:dsr12@tpu.ru)

Carbon quantum dots (CQDs) are attracting more and more attention as they have a number of advantages over quantum dots (nanoparticle-semiconductors). CQDs have found applications in engineering, environmental protection, biomedicine and energy due to their low toxicity, high biocompatibility, solubility, and good chemical inertness [1].

CQDs are semiconductor materials, their size does not exceed 10 nm. The core of CQDs consists of  $sp^2$  and  $sp^3$  hybridized carbon atoms, the surface of which is formed by various organic functional groups: amine, carbonyl, hydroxyl and others. The presence of a particular functional group depends on the synthesis method and leads to a change in luminescent properties.

There are two main approaches for the synthesis of CQDs: top-down and bottom-up. The top-down approach refers to the breaking of larger carbon structures using electrolysis, ultrasound, laser ablation and acid treatment. In the bottom-up approach, bulk carbon nanoparticles are formed from low molecular precursors using chemical and physical methods including hydrothermal, solvothermal, microwave and thermal pyrolysis [2].

The aim of this work is to synthesize and investigate the luminescent properties of CQDs obtained by different methods.

A mixture of 0.4 g of citric acid and 0.4 g of urea was used as carbon sources, which were dissolved in 10 ml of distilled water and treated by three different methods: heating in a microwave oven at 170 W for 90 s, heating on a hotplate at 200 °C for 60 min, and treatment in a muffle furnace at 200 °C for 60 min. The obtained yellow-orange product was dissolved in a small amount of NaOH with a concentration of 4 g/L. The resulting solution was then transferred into 20 mL of 4 g/L NaOH with vigorous stirring using a syringe. After that 0.1 M HCl solution was added to obtain neutral medium of the solution (pH = 7.1).

Further, the luminescence spectra of the obtained solutions were recorded using Fluorate-02-Panorama in k-10 quartz cuvettes at an excitation wavelength of 350 nm. As can be seen in Figure 1A, the maximum luminescence intensity was observed for the CQDs solution obtained by the hydrothermal approach under microwave irradiation (Figure 1A, curve 3). Figure 1B shows a photograph of the CQDs solution when exposed to UV light at 340 nm. This photo confirms the formation of CQDs with luminescent properties.

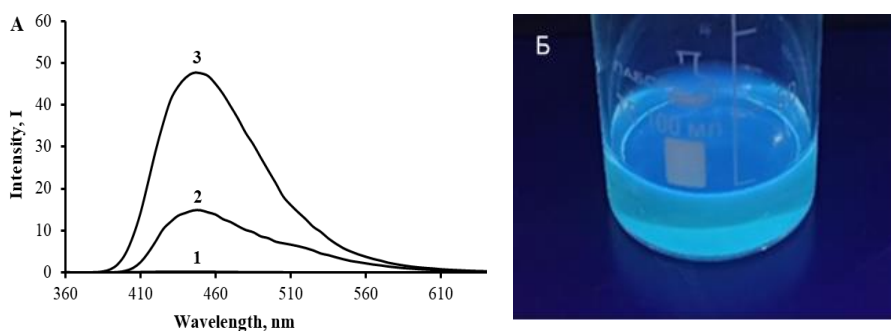

**Figure 1.** CODs luminescent spectra obtained from citric acid and urea: 1 - in a muffle furnace for 60 minutes at 200 °C; 2 - on a heating plate for 60 minutes at 200 °C, 3 - in a microwave oven at 170 W for 90 seconds.

## References

- [1] *Lumin.* **2023**, 38, 845  
[2] *Appl. Surf. Sci. Adv.* **2022**, 11, 100311

CURIE TEMPERATURE OF  $\text{Ni}_x\text{Zn}_y\text{Co}_{1-x-y}\text{O}_4$  ( $x=0-1$ ) FERRITE

*Sherstyuk D.P.*<sup>1</sup>, *Vinnik D.A.*<sup>1,2,3</sup>, *Zhivulin V.E.*<sup>1</sup>, *Shipkova E.D.*<sup>4</sup>, *Perov N.S.*<sup>4</sup>

<sup>1</sup> South Ural State University, Chelyabinsk, Russia

<sup>2</sup> St. Petersburg State University, St. Petersburg, Russia

<sup>3</sup> Moscow Institute of Physics and Technology, Dolgoprudny, Russia

<sup>4</sup> Moscow State University, Moscow, Russia

PhD student

[sherstiukd@susu.ru](mailto:sherstiukd@susu.ru)

A distinctive feature of materials with a spinel structure is the ability to form an extremely wide range of solid solutions. This means that the composition of a given ferrite can be greatly changed, while the type of crystal structure remains unchanged. The properties of ferrite can be significantly modified by partially or completely replacing matrix cations with others that differ in magnetic moment and radius. This change in structure makes it possible to effectively vary the properties of ferrites and ensure the adaptation of the material to specified requirements. In previous experimental work, it was possible to synthesize all samples of the concentration triangle of the  $\text{Ni}_x\text{Zn}_y\text{Co}_{1-x-y}\text{Fe}_2\text{O}_4$  solid solution system, where  $x$  and  $y = 0-1$  (step 0.1). The paper presents the results of a study of the Curie temperature of a solid solution system.

All samples of the system were obtained by solid-phase synthesis with a temperature and isothermal holding time of 1150°C and 5 h, respectively. As a result of X-ray phase analysis, it was established that all images are single-phase. Elemental analysis showed stoichiometric agreement. In Scheme. 1. The dependence of the unit cell parameter on the degree of substitution is presented. It can be seen that the dependence obeys Vegard's law. The Curie temperature was determined by analyzing the temperature dependence of magnetic permeability. The measurements were made by measuring the self-induction a core of a coil with a core at a frequency of 1 MHz.

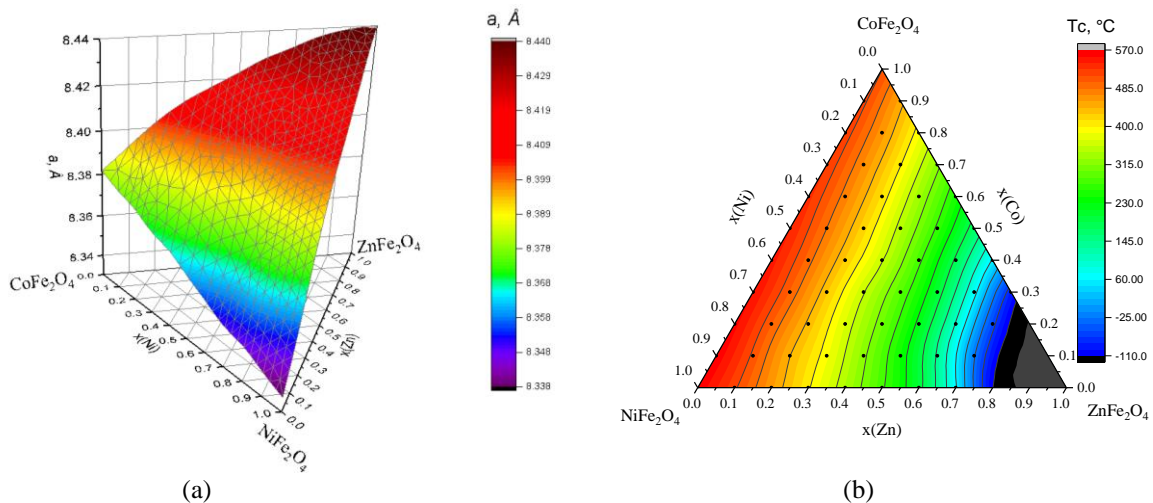

**Scheme 1.** Unit cell parameters (a), Curie temperature (b) of  $\text{Ni}_x\text{Zn}_y\text{Co}_{1-x-y}\text{O}_4$  ( $x=0-1$ ) system

According to Néel's theory, the Curie temperature depends on the strength of the exchange interaction between the AB sublattices in ferrite. An increase in the unit cell parameter leads to a decrease in the strength of exchange interaction with an increase in the degree of substitution of cations and, accordingly, to a decrease in the Curie temperature. In the system  $\text{Ni}_x\text{Zn}_y\text{Co}_{1-x-y}\text{O}_4$  ( $x=0-1$ ), the value of the unit cell parameter changes in the following form  $a(\text{NiFe}_2\text{O}_4) < a(\text{CoFe}_2\text{O}_4) < a(\text{ZnFe}_2\text{O}_4)$ , because  $r(\text{Ni}^{2+}) = 0.55 \text{ \AA}$  (CN4)  $< r(\text{Co}^{2+}) = 0.58 \text{ \AA}$  (CN4)  $< r(\text{Zn}^{2+}) = 0.6 \text{ \AA}$  (CN4), which affects the change in Curie temperature from 596°C ( $\text{NiFe}_2\text{O}_4$ ) to temperature values Neel, which lie well below room temperature (black corner of the triangle) - these temperatures could not be determined. The revealed pattern of changes in the Curie temperature depending on the composition makes it possible to optimize the compositions of the system under study for use in thermistors, magnetic sensors and pyroelectric detectors.

#### Acknowledgements

The authors acknowledge Saint-Petersburg State University for a research project 124032600009-5.

## SYNTHESIS OF BARIUM HEXAFERRITE WITH HIGH CHROMIUM SUBSTITUTION LEVEL AT DIFFERENT TEMPERATURES

*Sherstyuk D.P.<sup>1</sup>, Zykova A.R.<sup>1</sup>, Kovalev A.I.<sup>1</sup>, Zhivulin V.E.<sup>1</sup>, Vinnik D.A.<sup>1,2,3</sup>*

<sup>1</sup> South Ural State University, Chelyabinsk, Russia

<sup>2</sup> St. Petersburg State University, St. Petersburg, Russia

<sup>3</sup> Moscow Institute of Physics and Technology, Dolgoprudny, Russia

PhD student

[sherstiukd@susu.ru](mailto:sherstiukd@susu.ru)

The replacement of iron with chromium in barium hexaferrite leads to a change in the structural and magnetic properties of this material. Barium hexaferrite, which has the formula  $\text{BaFe}_{12}\text{O}_{19}$ , is a class of hard magnetic materials and is widely used in various applications. The introduction of chromium into the structure of barium hexaferrite can lead to a change in the size of the crystal lattice cell and possibly to the formation of new phases or defects in the structure.

The introduction of chromium into the composition of hexaferrite increases the ferritization temperature of the material, which causes great difficulties in obtaining ferrites with a high degree of substitution by solid-phase synthesis. Typically, with a degree of substitution  $x = 6-7$ , a secondary hematite phase appears in the  $\text{BaFe}_{12-x}\text{Cr}_x\text{O}_{19}$  composition. The current work presents the results of the synthesis of chromium-substituted barium hexaferrite obtained at three different temperatures.

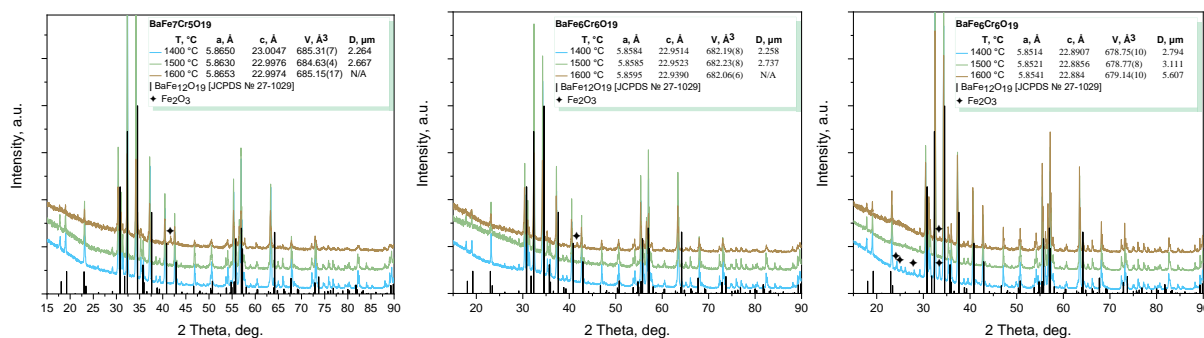

**Scheme 1.** XRD patterns of  $\text{BaCr}_5\text{Fe}_7\text{O}_{19}$ ,  $\text{BaCr}_6\text{Fe}_6\text{O}_{19}$ ,  $\text{BaCr}_7\text{Fe}_5\text{O}_{19}$

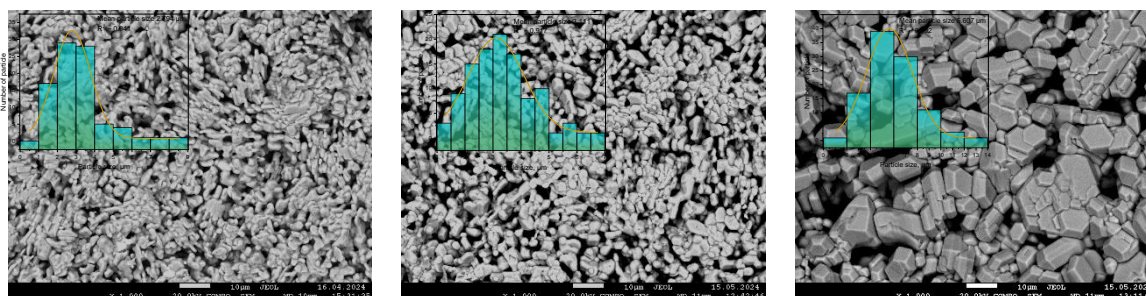

**Scheme 2.** SEM images of  $\text{BaCr}_7\text{Fe}_5\text{O}_{19}$  synthesized at 1400, 1500, 1600 °C

As a result of X-ray phase analysis, it was established that the  $\text{BaCr}_5\text{Fe}_7\text{O}_{19}$ ,  $\text{BaCr}_6\text{Fe}_6\text{O}_{19}$ ,  $\text{BaCr}_7\text{Fe}_5\text{O}_{19}$  samples synthesized at temperatures of 1400, 1500 and 1600 °C are single-phase with space group 167: R-3c, hexagonal P6<sub>3</sub>/mmc, with the exception of the  $\text{BaCr}_7\text{Fe}_5\text{O}_{19}$  sample at 1400 °C, in which the impurity phase  $\text{Fe}_2\text{O}_3$  was detected. Of particular interest is the dependence of changes in unit cell parameters, which change not only with increasing chromium content in the composition, but also with increasing synthesis temperature.

The surface morphology of the samples is a multitude of differently oriented hexagonal particles welded together. As expected, the average particle size increases with increasing synthesis temperature. In a sample sintered at 1600 °C, grains grow and agglomerate, which leads to a decrease in porosity within the particles. This barium hexaferrite sample with degree of chromium substitution = 7 has an average particle size of 5.607 μm, which is twice that of the sample sintered at 1400 °C. Samples of the composition  $\text{BaCr}_5\text{Fe}_7\text{O}_{19}$ ,  $\text{BaCr}_6\text{Fe}_6\text{O}_{19}$ , synthesized at 1500 and 1600 °C, were melted along the grain boundaries.

### Acknowledgements

The study was supported by the Russian Science Foundation grant No. 24-29-20187.

SYNTHESIS, CHARACTERIZATION AND ANTIMICROBIAL ACTIVITY OF 4,6-DI-*TERT*-BUTYL-2,3-DIHYDROXYBENZALDEHYDE-DERIVED SCHIFF BASES AND THEIR COPPER(II) COMPLEXES

*Turomsha I.S.*<sup>1,2</sup>, *Gvozdev M.Y.*<sup>1</sup>, *Loginova N.V.*<sup>1,2</sup>, *Khodosovskaya A.M.*<sup>1</sup>, *Ksendzova G.A.*<sup>2</sup>,  
*Osipovich N.P.*<sup>2</sup>, *Koval'chuk-Rabchinskaya T.V.*<sup>1</sup>,

<sup>1</sup> Belarusian State University, Minsk, Belarus

<sup>2</sup> Research Institute for Physical Chemical Problems, Minsk, Belarus

Turomsha I.S. (undergraduate student)

[loginov@gmail.com](mailto:loginov@gmail.com)

Metal complexes have become of interest as antimicrobial agents due to the lack of novel potent antibiotics for the eradication of multidrug resistant microorganisms. As an endogenous metal ion possessing biochemical detoxification pathways, Cu(II) is well tolerated by the human organism. Cu(II) functions as a metalloenzyme cofactor in superoxide dismutase, cytochrome *c* oxidase, tyrosinase, lysyl oxidase, and is capable of displacing zinc in its metalloproteins, rendering their structure inactive [1]. The redox transition between Cu(I) and Cu(II) may lead to the formation of reactive oxygen species, which are known to damage genomic and plasmid DNA, lipids, and proteins. Schiff bases constitute a group of synthetically accessible compounds bearing azomethine nitrogen atoms that may disrupt cellular homeostasis by forming hydrogen bonds with cell constituents. They have been found to exhibit antimicrobial, antiprotozoan, anti-inflammatory, anticancer, and other biological activities [2].

4,6-di-*tert*-butyl-2,3-dihydroxybenzaldehyde-derived Schiff bases and their Cu(II) complexes were obtained and characterized by means of NMR, FT-IR, UV-Vis spectroscopy, elemental analysis, XRD analysis, EPR spectroscopy, thermogravimetric analysis, electrochemical measurements, and quantum chemical calculations. Schiff bases were synthesized by the reaction of 1,2-, 1,3-diaminoalkanes, 4-aminopyridine, *p*-anisidine and sulfanilamide with 4,6-di-*tert*-butyl-2,3-dihydroxybenzaldehyde using ethanol and anhydrous methanol as solvents. Enhancement of the antimicrobial activity as well as reduction in the toxicity of the Schiff base ligands are observed upon their coordination with Cu(II) ion. For the ligands, minimal inhibitory concentration (MIC) values fall within the range of 0.124-0.306  $\mu\text{mol/mL}$ , whereas the corresponding Cu(II) complexes demonstrate more potent antimicrobial effects characterized by the MIC values of 0.057-0.140  $\mu\text{mol/mL}$ . This occurs due to the electron delocalization and reduced polarity of Cu(II) ion interacting with *N,O*-donor binding sites that result in increased lipophilicity and facilitated cell membrane permeation of the system. The Cu(II) complexes have displayed a remarkable binding affinity towards bovine serum albumin ( $\log K_b = 4.24$ - $5.62$ ), which indicates their high bioavailability upon potential medical applications. Furthermore, hemolytic activity of the Cu(II) complexes has been shown to decrease compared to the parent ligands. Therefore, Cu(II) complexes of Schiff bases show promise for the development of effective therapeutic agents for medicinal chemistry.

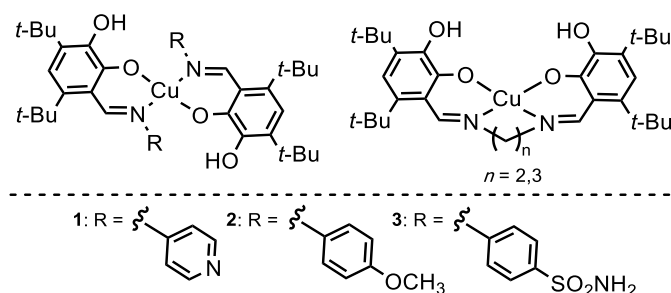

**Scheme 1.** Plausible coordination modes of the synthesized Cu(II) complexes.

## References

- [1] *Dalton Trans.* **2017**, 46, 33  
[2] *J. Coord. Chem.* **2020**, 73, 23

## Acknowledgements

This work was supported by the grant 2.2.01.05 SRP "Chemical processes, reagents and technologies, bioregulators and bioorganic chemistry".

NEW  $^{99m}\text{Tc}$  RADIOPHARMACEUTICALS FOR MYOCARDIAL METABOLIC PROCESSES

*Tyupina M.Yu.*<sup>1,2</sup>, *Miroslavov A.E.*<sup>1,2,3</sup>, *Sidorenko G.V.*<sup>1,2</sup>, *Sakhonenkova A.P.*<sup>1,2,3</sup>

<sup>1</sup> Khlopin Radium Institute, St. Petersburg, Russia

<sup>2</sup> Ozyrsk Technological Institute of the National Research Nuclear University, Ozyrsk, Russia

<sup>3</sup> St. Petersburg State University, St. Petersburg, Russia

Head of Laboratory, Ph.D.

[mtupina@spbu.ru](mailto:mtupina@spbu.ru)

Previously we showed that the heart uptake of «2+1» tricarbonyl complexes of technetium with 1,10-phenanthroline and 2,2'-bipyridine is comparable to that of MIBI [1]. We also found that isocyanides form strong complexes with technetium(I) [2]. These data suggest that «2+1» tricarbonyl complexes of technetium with 1,10-phenanthroline and 2,2'-bipyridine show promise for introduction of technetium via the isocyanide group into fatty acids [3] with the aim to develop a new technetium radiopharmaceutical for heart metabolic process. In this work we developed a procedure for preparing «2+1» tricarbonyl complexes of technetium-99 and rhenium with a combination of the bidentate ligands and fatty acid isocyanides (CN(CH<sub>2</sub>)<sub>4</sub>CH(COOMe)SC<sub>10</sub>H<sub>21</sub>, CN(CH<sub>2</sub>)<sub>10</sub>COOMe). The complexes were isolated and characterized by IR and NMR spectroscopy. The IR spectrum of the complexes contains three bands typical for the tricarbonyl fragment. The coordination of the isocyanide group is confirmed by the <sup>1</sup>H NMR. Based on the results obtained we developed the procedure for preparing «2+1» tricarbonyl complexes of technetium-99m,99:

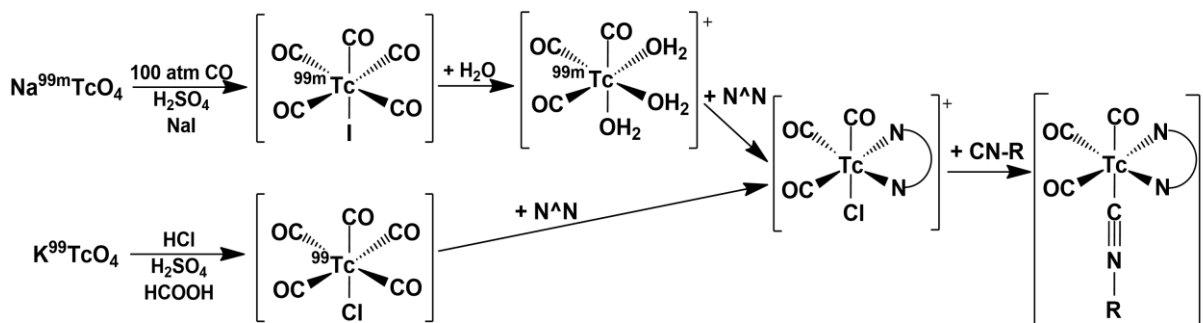

where N^N = bipy, phen

**Scheme 1.** The procedure for preparing «2+1» tricarbonyl complexes of technetium-99m,99

These complexes were obtained and characterized by HPLC using technetium-99 analogs as the reference. The lipophilicity of the technetium-99m complexes was measured.

### References

- [1] *J. Label. Comp. and Radiopharm.* **2013**, 56, 700  
 [2] *Inorg. Chem.* **2014**, 53, 7861  
 [3] *Inorg. Chem.* **2023**, 62, 15593

### Acknowledgements

This work was supported by the Russian Science Foundation (project No 22-13-00057).

## SYNTHESIS AND LUMINESCENT PROPERTIES OF POLYMETHINE DYES BASED ON BORON DIKETONATE COMPLEXES

*Zavodianskii M.A.*<sup>1</sup>, *Tretyakova G.O.*<sup>1,2</sup>, *Svistunova I.V.*<sup>1</sup><sup>1</sup> Far Eastern Federal University, Vladivostok, Russia<sup>2</sup> Far Eastern Branch of the Russian Academy of Sciences, Vladivostok, Russia

Student

[zavodianskii.ma@dvfu.ru](mailto:zavodianskii.ma@dvfu.ru)

Tetraordinated boron complexes can be used as optical sensors, laser active dyes and other luminescent materials [1].

Complexes 1a and 2a (fig. 1) were obtained by reacting in the presence of base between boron difluoride acetylacetonate and benzaldehyde or furfural, respectively. Compounds 1b–1d and 2b–2d were obtained by reacting 1a and 2a with the corresponding organic acid in the presence of an aluminum chloride catalyst.

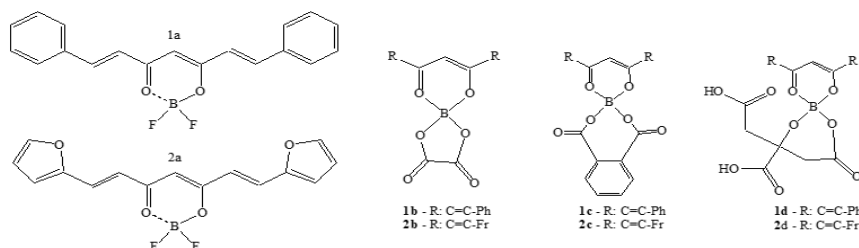

**Figure 1.** Structures of the studied compounds

A study of the luminescence spectra of solutions of the obtained compounds showed (fig. 2) that for compounds 1a–1d, the position of the maxima of the excitation spectra does not change depending on the soligand and is at a wavelength of 450 nm. At the same time, the luminescence spectra differ slightly. For spiroborate 1d, there is a slight hypsochromic shift relative to 1a due to volumetric substituents in the citric acid structure, which most likely affect the geometry of the molecule, making it less flat, violating quasi aromaticity. The bathochromic shift of the maxima of the luminescence spectra of complexes 1b, 1c is explained by the smaller size of the soligands. For complexes 2a–2d, similar shifts of maxima are observed depending on the soligand. The largest bathochromic shift of the maximum luminescence spectrum for a complex with phthalic acid is explained by the possibility of formation of additional stacking interactions.

With an increase in the concentration of solutions of the studied complexes, a bathochromic shift of the maxima of the excitation and luminescence spectra (about 50 nm) is observed. The largest bathochromic shift of the maxima for the complex with oxalic acid is explained by its smaller size, increasing the overlap of molecules in the condensed state.

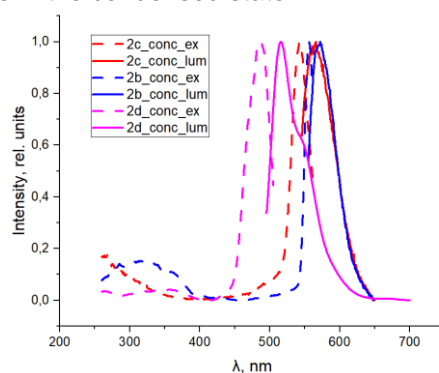

**Figure 2.** Normalized luminescence and luminescence excitation spectrum of concentrated 2b-2d solutions

### References

[1] *Dyes and Pigments*. **2021**, 193, 109538.

### Acknowledgements

The research was carried out at the expense of a grant from the Russian Science Foundation No. 23-23-00463.



# **THEORETICAL CHEMISTRY**





# **KEYNOTE & INVITED SPEAKERS**



## KEYNOTE SPEAKER



### **Dr. Sci., Prof. Konstantin Lyssenko**

*Professor of the Russian Academy of Sciences, Lomonosov Moscow State University, Moscow, Russia*

**Experimental Charge Density Studies of Crystalline Solids as the Inexhaustible Source of Data on Interatomic Interactions**

## INVITED SPEAKERS

### **Dr., Prof. Denis Sabirov**

*Institute of Petrochemistry and Catalysis – Subdivision of the Ufa Federal Research Centre of the Russian Academy of Sciences, Ufa, Russia*

**Information Entropy in Theoretical Chemistry**



### **Dr. Andrey Kulsha**

*Belarusian State University, Minsk, Belarus*

**Strong Bases Design: Key Techniques and Stability Issues**

EXPERIMENTAL CHARGE DENSITY STUDIES OF CRYSTALLINE SOLIDS AS THE  
INEXHAUSTIBLE SOURCE OF DATA ON INTERATOMIC INTERACTIONS

*Lyssenko K.A.*<sup>1</sup>

<sup>1</sup>Lomonosov Moscow State University, Moscow, Russia  
Professor of the Russian Academy of Sciences, Doctor Sci.  
[klyssenko@gmail.com](mailto:klyssenko@gmail.com)

The possibilities of modern X-ray diffraction experiment for studying the nature of interatomic interactions in crystals of organic, organometallic and organometallic compounds will be considered on a number of only expected but rather exotic examples.

## INFORMATION ENTROPY IN THEORETICAL CHEMISTRY

*Sabirov D.Sh.*

Institute of Petrochemistry and Catalysis of Russian Academy of Sciences, Ufa, Russia

Dr. Habilitatus

[sabirovdsh@mail.ru](mailto:sabirovdsh@mail.ru)

Information entropy was introduced in the theory of communication and information sciences by C.E. Shannon in 1948 [1] and then found applications in natural sciences [2]. The interest in information entropy grows due to the trend for digitalization in chemistry [3]. In the lecture, basic applications of this concept to chemical objects are discussed, such as quantifying structural and electronic properties of molecules, crystals and molecular ensembles, signal processing etc. [4].

We focus on the information entropy as a structural descriptor, which is used for assessing molecular complexity in the discrete mathematical chemistry [5–7]. This point is important for understanding the applications of information entropy in QSAR/QSPR studies and computational protocols for automated classification of chemical structures [8].

The information entropy of molecular ensemble is not additive value [9, 10] being not a simple sum of the information entropies of its molecules. It includes the additional term, which is called cooperative entropy, and depends only on the size of the molecules. The peculiarities of the ensemble entropy in the context of this emergent contribution are considered [10]. This feature causes special rules for calculating the information-entropy changes at chemical reactions and allows separate assessing the size-dependent and structure-dependent changes in molecular complexity [11]. The relation between the information entropy of a complex chemical reaction and the stage parameters is introduced and exemplified with parallel [12], catalytic [13] and successive reactions [14].

We mention works of Russian scientists [15–18], who were pioneers in chemical applications or considered the title quantity for novel chemical concepts. Links of the information-entropy-based structural-chemistry studies with mineralogy [19, 20], thermodynamics [21] and information sciences [22, 23] are considered. Recent advances in the mentioned areas make information entropy a central concept in interdisciplinary studies on digitalizing chemical reactions, chemico-information synthesis, crystal engineering, as well as revisiting basic chemical notions in terms of informatics.

**References**

- [1] C.E. Shannon, *Bell Syst. Tech. J.* **1948**, 27, 379.
- [2] H. Haken, *Information and Self-Organization: A Macroscopic Approach to Complex Systems*, **1989**.
- [3] D.Sh. Sabirov, *Vestn. Bashkirsk. Univ.* **2021**, 26, 27.
- [4] D.Sh. Sabirov, I.S. Shepelevich, *Entropy* **2021**, 23, 1240.
- [5] S.J. Barigye, Y. Marrero-Ponce, F. Pérez-Giménez, D. Bonchev, *Mol. Divers.* **2014**, 18, 673.
- [6] S.C. Basak, B.D. Gute, G.D. Grunwald, *J. Chem. Inf. Comput. Sci.* **1997**, 37, 651.
- [7] D.Sh. Sabirov, O. Ori, A.A. Tukhbatullina, I.S. Shepelevich, *Symmetry* **2021**, 13, 1899.
- [8] D.Sh. Sabirov, A.A. Tukhbatullina, I.S. Shepelevich, *Symmetry* **2022**, 14, 1800.
- [9] D.Sh. Sabirov, *Comput. Theor. Chem.* **2018**, 1123, 169.
- [10] D.Sh. Sabirov, *Comput. Theor. Chem.* **2020**, 1187, 112933.
- [11] D.Sh. Sabirov, A.A. Tukhbatullina, I.S. Shepelevich, *J. Mol. Graph. Model.* **2022**, 110, 108052.
- [12] A.D. Zimina, I.S. Shepelevich, D.Sh. Sabirov, *Russ. J. Phys. Chem. A* **2023**, 97, 2099.
- [13] A.D. Zimina et al., *Dokl. Phys. Chem.* **2024**, 513, 181.
- [14] D.Sh. Sabirov et al., *J. Math. Chem.* **2024**, 62, 819.
- [15] N.I. Kobozev, *Russ. J. Phys. Chem. A* **1966**, 40, 281.
- [16] Yu.A. Zhdanov, *Information Entropy in Organic Chemistry*, Rostov Univ., **1979**.
- [17] V.B. Aleskovskii, *Russ. J. Gen. Chem.* **2002**, 72, 569.
- [18] V.M. Talanov, V.V. Ivanov, *Russ. J. Gen. Chem.* **2013**, 83, 2225.
- [19] S.V. Krivovichev, *Mineral. Mag.* **2013**, 77, 275.
- [20] S.N. Volkov et al., *Solid State Sci.*, **2024**, 148, 107414.
- [21] S. Shang, Y. Wang, Z. Liu, *Scripta Materialia* **2023**, 225, 115164.
- [22] M.D. Bal'makov, *Russ. J. Gen. Chem.* **2002**, 72, 1023.
- [23] B.B. Kadomtsev, *Phys. Uspekhi* **1994**, 37, 425.

**Acknowledgements**

This work was supported by the Russian Science Foundation (project No 22-13-20095).

## STRONG BASES DESIGN: KEY TECHNIQUES AND STABILITY ISSUES

Kulsha A.V., Ivashkevich O.A.<sup>2</sup>

<sup>2</sup> Research Institute for Physical Chemical Problems of the Belarusian State University, Minsk, Belarus  
Ph.D. Student  
[Andrey\\_601@tut.by](mailto:Andrey_601@tut.by)

Numerous applications of strong bases in organic synthesis [1,2] led to increased interest in various kinds of new molecular bases [3]. However, none of them significantly exceeded the strength of Schwesinger's polyphosphazenes (Scheme 1) that have been a gold standard for more than 30 years [4]. Consequently, a challenge arose to design new molecular bases theoretically [5]. Unfortunately, although some predictions have found excellent experimental confirmation, the vast majority of theoretically proposed structures remain far from real life [6].

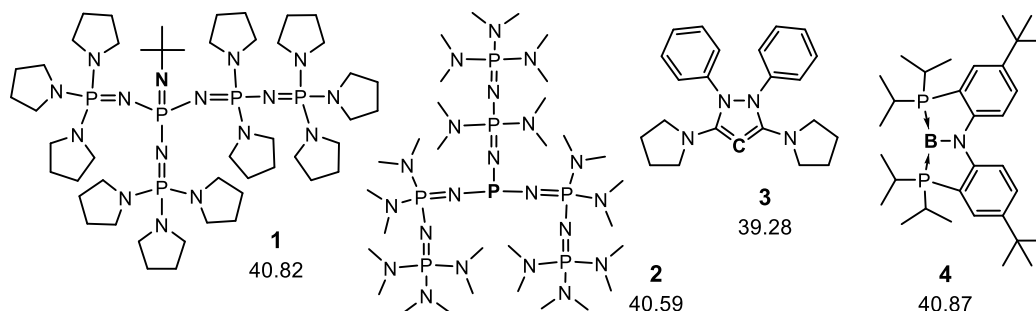

**Scheme 1.** The most basic known azene **1** (Schwesinger, 1993), phosphine **2** (Sundermeyer, 2019), carbene **3** (Bertrand, 2021), and borylene **4** (Kong, 2023) along with computed  $pK_a$  values of their protonated forms in hexamethylphosphoramide (HMPA). Protonation sites are shown in bold.

In this work, the 25-year history of quantum chemical design of strong molecular bases is briefly reviewed. The existing approaches to strong bases design are systematized yielding a general five-step guide to superbasic molecules construction. More importantly, the unsuccessful cases are deeply analyzed, and the main instability reasons of theoretically predicted structures in superbasic media are identified. Explicit examples of step-by-step design are used to illustrate the possible problems using sample structures as well as the examples from literature. As a result, another five-step guide to checking the stability of bases with quantum chemistry methods is developed.

Successful design cases are introduced to demonstrate the future prospects of molecular superbases design (Scheme 2). Structure **5b** is predicted to be stronger than Schwesinger's  $t\text{Bu-P}_4$ , while having a metal atom as the protonation site. Structure **6b** is predicted to set the practical basicity limit in the solution, while its protonated form **6bH<sup>+</sup>** appears to be a robust weak-coordinating cation.

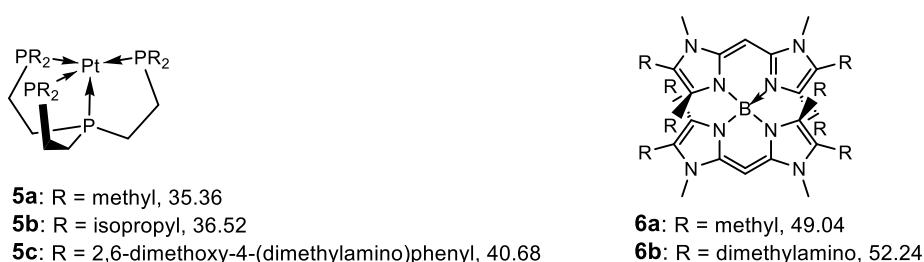

**Scheme 2.** New designed superbases and computed  $pK_a$  values of their protonated forms in HMPA.

## References

- [1] *Chem. – Eur. J.* **2021**, 27, 4216. DOI: 10.1002/chem.202003580
- [2] *Chem. Probl.* **2022**, 20, 325. DOI: 10.32737/2221-8688-2022-3-325-340
- [3] *Chem. Heterocycl. Compd.* **2012**, 48, 200. DOI: 10.1007/s10593-012-0983-5
- [4] *Angew. Chem., Int. Ed. Engl.* **1993**, 32, 1361. DOI: 10.1002/anie.199313611
- [5] *Acc. Chem. Res.* **2021**, 54, 3108. DOI: 10.1021/acs.accounts.1c00297
- [6] *J. Phys. Chem. A* **2022**, 126, 3642. DOI: 10.1021/acs.jpca.2c00521

## Acknowledgements

This work was supported by the Belarusian Republican Foundation for Fundamental Research (grant X24MC-004).



# **ORAL & POSTER PRESENTATIONS**

## THERMODYNAMIC CHARACTERISTICS OF HUMIC ACIDS

*Alyeva A.B.*<sup>1</sup>, *Ananicheva S.A.*<sup>1,2</sup>, *Krapivnitckaia T.O.*<sup>1</sup>, *Gerasimova E.V.*<sup>1,2</sup>, *Peskov N.Yu.*<sup>1,2</sup>,  
*Zelentsov S.V.*<sup>1,2</sup>, *Glyavin M.Yu.*<sup>1</sup>

<sup>1</sup>Institute of Applied Physics, Russian Academy of Sciences, Nizhny Novgorod, Russia

<sup>2</sup>Lobachevsky State University of Nizhny Novgorod, Nizhny Novgorod, Russia

Researcher, PhD in Chemistry

a.alieva@ipfran.ru

One of the modern and rapidly developing methods is processing of natural raw materials using the controlled influence of powerful electromagnetic radiation in the microwave range [1]. Currently, peat is a promising natural raw material for processing. Furthermore, it is considered as a complex multicomponent system, which includes several groups of chemical compounds, such as lignin, humic and fulvic acids, cellulose.

Humic acids are a mixture of macromolecules of various compositions and structures. Establishing the relationship between structures and physicochemical properties and behavior under various conditions is one of the fundamental problems of chemistry. Due to modern quantum chemical methods, it is possible to correctly describe geometries, electronic structures, and enthalpy values.

In this article, the structures of humic acids are optimized and thermodynamic parameters are calculated: the values of the total enthalpy  $H^\circ$ , the total correction for the temperature of 298 K and the vibrational energy  $0^\circ\text{K}$  – Zero-point energy (ZPE) and the difference between the Gibbs free energy of the transition state and the calculated on their basis the initial molecule of humic acid  $G^\circ$ , as well as the dipole moment characterizing the interaction of the molecule with microwave radiation. The calculation results are shown in Table 1.

**Table 1.** Calculations results of humic acid using quantum chemistry methods.

Method	$H^\circ$ , Mcal·mol <sup>-1</sup>	T·S <sup>o</sup> , kcal·mol <sup>-1</sup>	ZPE, kcal·mol <sup>-1</sup>	$G^\circ$ , Mcal·mol <sup>-1</sup>	Dipole moment, D
BP86	-1730.988	-96.5	570.8	-1731.084	6,62
B3LYP	-1729.909	-94.8	588.3	-1730.004	6,18
BP86&B3LYP	-1730.988	-96.5	570.8	-1731.084	6,15
$\omega$ B97X-D3	-1730.517	-90.4	596.5	-1730.607	4,29

To carry out the calculations, a wide range of quantum chemical methods were used. The initial approximation was computed on the basis of the second-order Møller-Plesset perturbation theory (MP2). Subsequent calculations were conducted using hybrid methods B3LYP, BP86, a combination of BP86&B3LYP,  $\omega$ B97X-D3 [2]. The computation was carried out using the ORCA 4.2 program. The geometric parameters determined using the above methods differ slightly. The resulting optimized structures of humic acid molecules were used in the calculations of their thermodynamic parameters.

The thermodynamic parameters such as the enthalpy of formation and the Gibbs function using the above methods are comparable, while the results of the most energetically favorable state of humic acids were obtained using the BP86 method, which allows calculations to be carried out in a shorter period of time, unlike other methods used in this work. As can be seen from Table 1, there is a difference in the dipole moment values obtained using different methods.

Thus, the results of this work contribute to the development of microwave pyrolysis of peat [3]. Thermodynamic calculations make it possible to determine the optimal parameters for the process and further increase the efficiency of pyrolysis. In particular, such modeling of this process allows the selection of appropriate catalytic systems with high activity and low cost.

### References

- [1] *Processes* **2023**, *11*, 1924
- [2] *Journal of Molecular Structure*, **2021**, 128973
- [3] *High Energy Chemistry*, **2023**, *57*, 384

### Acknowledgements

This work was supported by the Russian Science Foundation (project No 23-19-00763).





## THE MOLECULAR DYNAMICS OF THE STRUCTURAL BEHAVIOUR OF THE ALCOHOL DEHYDROGENASE ENZYME ON THE ADSORBENT SURFACE

*Baigunov I.A.<sup>1</sup>, Kholmurodov Kh.T.<sup>1,2</sup>, Gladyshev P.P.<sup>1</sup>, Ibrahim M. A.<sup>3,4</sup>*

<sup>1</sup>Department of Chemistry, New Technologies and Materials, Dubna State University, 141980, Dubna, Moscow Region, Russia

<sup>2</sup>Frank Laboratory of Neutron Physics, Joint Institute for Nuclear Research, 141980, Dubna, Moscow Region, Russia

<sup>3</sup>Spectroscopy Department, National Research Centre, 33 El-Bohouth St., 12622, Dokki, Giza, Egypt.

<sup>4</sup>Molecular Modeling and Spectroscopy Laboratory, Centre of Excellence for Advanced Science, National Research Centre, 33 El-Bohouth St., 12622, Dokki, Giza, Egypt.

3rd year postgraduate student

[vanes1997fev@gmail.com](mailto:vanes1997fev@gmail.com)

Computational methods offer important ways to describe and understand molecular phenomena in many systems. These methods are widely used in chemical [1] as well as biological sciences [2]. It is argued that the development of computer software and programs has allowed great advances in the prediction of several important molecular interactions that transfer protein and ligand to the binding site, as well as in the design and subsequent discovery of several drugs [3]. In this work, computer molecular dynamics and experimental studies of the enzyme alcohol dehydrogenase (ADH) in aqueous solution were carried out. MD simulation data are discussed in conjunction with experimental observations of the effect of solution pH on protein conformation and its orientation on the adsorbent surface. The issues of orientation of protein sorption on matrices of various sorbents are also covered. The numerical experiment implemented in the study using the AMBER pmemd.cuda package provides mapping of the orientational adsorption of the ADH enzyme with a significant expansion of the original basic model, thereby allowing the change in protein conformation in the region of the titratable amino acid residues of ADH to be observed in detail. Detection of the characteristic conformation of key titratable amino acids may become a necessary stage in further research and implementation of a numerical experiment, which will be carried out by varying the pH values and water-salt balance. Subsequently, this discovery may clarify the ways of surface modification with positively or negatively charged groups, thereby simulating the properties of real sorbents used for protein immobilization.

### References

1. Foresman J., Frish E. Exploring chemistry //Gaussian Inc., Pittsburg, USA. – 1996. – T. 21.
2. Leach A. R. Molecular modelling: principles and applications. – Pearson education, 2001.
3. Welborn V. V. Structural dynamics and computational design of synthetic enzymes //Chem Catalysis. – 2022. – T. 2. – №. 1. – C. 19-28.

# DIFFRACTION PATTERNS DIFFERENCE AS A DRIVING FORCE IN MOLECULAR DYNAMICS

*Bashirov I.I.*<sup>1,2,3</sup>, *Chaliy V.A.*<sup>1,3</sup>, *Krivoshchapov N.V.*<sup>1,3</sup>, *Medvedev M.G.*<sup>1,3</sup>

<sup>1</sup>*N.D. Zelinsky Institute of Organic Chemistry of Russian Academy of Science, Moscow, Russia*

<sup>2</sup>*Department of Chemistry, Lomonosov Moscow State University, Moscow, Russia*

<sup>3</sup>*Bauman Moscow State Technical University, Moscow, Russia*

Student

[igorstan987@gmail.com](mailto:igorstan987@gmail.com)

Molecular dynamics algorithm (MD) is a well-known computational method that has many different applications, such as polymorphic modifications search and solid-state reactions simulation. However, large periodic systems usually require MDs with long simulation times (1ms - 1s) to change their states. In this work we propose a method of diffraction pattern-based biased molecular dynamics that propels a system into yet unsampled regions of the configurational space.

In our method the diffraction pattern of the periodic system is generated on every step of MD and then the difference between the current pattern and the reference pattern is evaluated [1] and differentiated with respect to atomic positions to provide additional forces (bias) to be added to the atomic forces. After applying these forces, the system is pushed to change its diffraction pattern to become more similar or different to the reference system. There are two main choices for the reference pattern:

- Specific pattern. This mode can be used to drive the system in the MD to a specific diffraction pattern in order to determine the structure that corresponds to this pattern. We show that this mode can be effective with crystals of simple organic compounds.
- A pattern corresponding to one of the preceding snapshots in the MD. In this case the system will try to “escape” its current state at every step. We show that in this mode the system will change its structure drastically in a short simulation time.

Furthermore, we show that it is possible to design a crystallinity measure based on diffraction pattern, which allows one to push a crystal structure to become more or less symmetric.

Thus, our approach can be used to finely control molecular dynamics of any 3D periodic molecular system. It is useful in the polymorphic modifications search and crystal structure prediction from X-ray diffraction patterns.

## References

[1] *Journal of Computational Chemistry* 22.3 **2001**: 273.

## Acknowledgements

This work was supported by the Russian Science Foundation (project No 22-13-00122).

## A NOVEL APPROACH FOR CONFORMATION SPACE SAMPLING VIA BAYESIAN OPTIMIZATION

*Bespalov I.A.<sup>1,2,3</sup>, Krivoshchapov N. V.<sup>1,3</sup>, Chaliy V.A.<sup>1,3</sup>, Medvedev M.G.<sup>1,3</sup>*

<sup>1</sup>N.D. Zelinsky Institute of Organic Chemistry of Russian Academy of Science, Moscow, Russia

<sup>2</sup>Lomonosov Moscow State University, Department of Chemistry, Moscow, Russia

<sup>3</sup>Bauman Moscow State Technical University, Moscow, Russia

Student

[ivan.a.bespalov@gmail.com](mailto:ivan.a.bespalov@gmail.com)

Bayesian optimization on Gaussian Process is a powerful machine learning approach for efficiently locating global minima of expensive-to-evaluate black-box functions. In his recent work Lucian Chan described the use of Bayesian optimization for solving conformational search problem [1]. However, Bayesian Optimization and Gaussian Process has no idea about chemistry and dependencies of predicting values. So, we came up with the idea of creating a conformational search method with Bayesian optimization based on Gaussian Process, where the kernel function has a component that “has knowledge” about torsion angle potentials. This trick should keep the model from wasting time figuring out dependencies of energy on torsion angle rotation and quickly locate all low-energy conformers. Our conformational search method consists of the following steps:

- The next-to-calculate structure is selected based on the input, or acquisition function, which designates the Gaussian Processes’ best guess of the next lowest-energy conformer.
- This structure is optimized using any appropriate quantum chemical method to provide an optimization trajectory, which is clusterized in the torsion angles’ space, and from each cluster a structure with lowest energy is selected to be added to the Gaussian Processes Regression model.
- After the end of the search, all located structures are clusterized together, providing a set of located unique geometries.

We show that adding the component, that “has knowledge” about torsion angle potentials, significantly diminishes the number of quantum chemical calculations required to localize the global minimum.

Furthermore, we designed our own acquisition function (sampling strategy). Bayesian optimization is created for efficiently locating global minimum, but in our task we want to not only find the global minimum, but also to acquire all low-energy conformers. Our acquisition function helps Bayesian optimization to shift the focus from exact global minimum locating to efficient exploration of low-energy regions of conformational space.

Thus, our approach allows one to efficiently locate low-energy conformations of organic molecules, an extremely important step in obtaining reliable results with molecular modeling.

### References

- [1] Journal of cheminformatics **2019**, 11(1), 1-11.

## PHOTOINDUCED DEGRADATION OF FLAVIN MONONUCLEOTIDE (FMN) IN MINISOG PROTEIN

*Blinova A.R.*<sup>1,2</sup>, *Mulashkina T.I.*<sup>1,2</sup>, *Grigorenko B.L.*<sup>1,2</sup>

<sup>1</sup> Moscow State University, Moscow, Russia

<sup>2</sup> N.M. Emanuel Institute of Biochemical Physics RAS, Moscow, Russia  
Postgraduate

[lady.buka-zluka2016@yandex.ru](mailto:lady.buka-zluka2016@yandex.ru)

Photodynamic therapy is one of the most promising methods for cancer treatment. Reactive oxygen species (ROS) could be considered as the agents of such therapy, and fluorescent proteins and their chromophores can be used to generate them [1]. One such protein is miniSOG, a small flavin-containing fluorescent protein that generates singlet oxygen when excited by blue light [2]. There have been several studies on creating protein mutants with a higher quantum yield of singlet oxygen production [3, 4]. Under intense irradiation, the flavin mononucleotide (FMN) bound to miniSOG degrades, leading to an increase in singlet oxygen production. It is thought that this occurs because FMN degrades into lumichrome (LC), freeing up the chromophore cavity from the ribityl tail and making it more accessible to oxygen. Based on this, miniSOG mutants could potentially be used as photodynamic therapy agents, contributing to the degradation of FMN into LC and binding the newly formed LC chromophore with high affinity. Therefore, it would be beneficial to investigate not only the generation of singlet oxygen in the FMN-oxygen system but also the decomposition of the chromophore, which could lead to the production of an even more effective ROS generator.

In this study, we characterized possible ways of FMN degradation in miniSOG in the presence of oxygen. They can be divided into two categories depending on the initial stage of the reaction: whether proton-coupled electron transfer to the isoalloxazine ring of the chromophore occurs from the hydroxyl group of the ribityl tail or from C $\alpha$  atom of the hydroxyl group. In addition, the crucial role of the chromophore conformation and the protein environment for the choice of the preferred reaction pathway was determined.

In our work, we used a combined quantum mechanics/molecular mechanics (QM/MM) method to study the potential energy surface of the selected system, as well as molecular dynamics with QM/MM potentials (QM/MM MD) to calculate Gibbs free energy profiles. The molecular mechanical part of the system was described using the parameters of the CHARMM36 force field; the quantum mechanical part was described with density functional theory (PBE0/D3).

### References

- [1] *Exp. Mol. Med.* **2021**, 53, 495
- [2] *PLoS Biol.* **2011**, 9, e1001041
- [3] *J. Am. Chem. Soc.* **2015**, 137, 632
- [4] *J. Phys. Chem. B.* **2017**, 121, 9366

### Acknowledgements

This work was supported by the Russian Science Foundation (project #22-13-00012). We acknowledge the use of supercomputer resources of the Joint Supercomputer Center of the Russian Academy of Sciences and the equipment of the shared research facilities of HPC computing resources at Lomonosov Moscow State University.

# BIOLUMINESCENCE OF THE FIREFLY: MODELING THE PREOXIDATION STAGE OF MECHANISM

*Blinova A.R.<sup>1,2</sup>, Kulakova A.M.<sup>1,2</sup>, Zakharova T.M.<sup>1</sup>, Grigorenko B.L.<sup>1,2</sup>*

<sup>1</sup> Moscow State University, Moscow, Russia

<sup>2</sup> N.M. Emanuel Institute of Biochemical Physics RAS, Moscow, Russia  
Postgraduate

[lady.buka-zluka2016@yandex.ru](mailto:lady.buka-zluka2016@yandex.ru)

Bioluminescence is the unique natural phenomenon, by which living beings produce light. It is widely used both in biotechnology and biomedicine [1]. The most characterized bioluminescent system to date is firefly luciferase [2]. Despite a great deal of experimental and theoretical research in this area, the exact mechanism behind its bioluminescence remains unclear.

The generally accepted scheme of firefly catalytic activity represents a three-stage process (scheme 1): 1) the reaction between D-luciferin (the luciferase substrate) and ATP to form D-luciferyl adenylate, which is then deprotonated; 2) the oxidation of the deprotonated intermediate to dioxetanone; and 3) the decomposition of dioxetanone into excited oxyluciferin, which is the light emitter in firefly bioluminescence. While most theoretical works have focused on steps 2 and 3, step 1 has not received as much attention, particularly due to impossibility of the fixation of luciferin-ATP complex crystal structure.

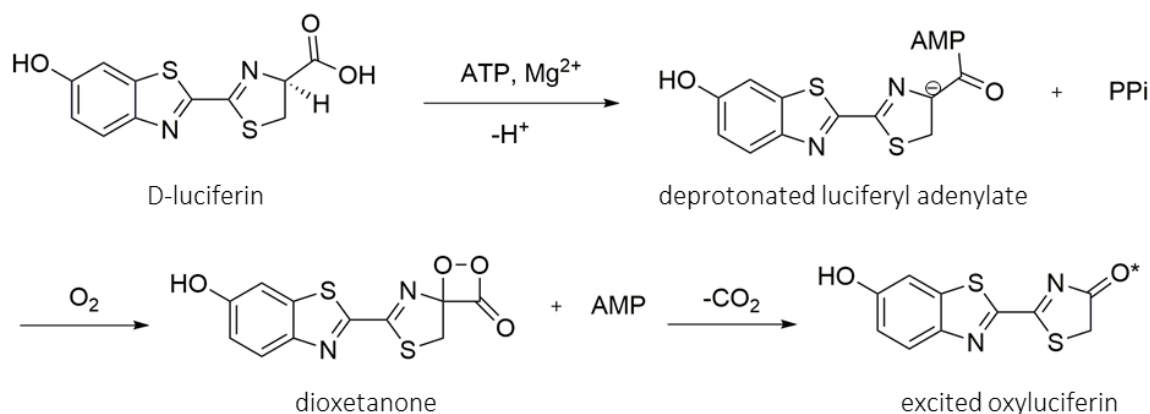

**Scheme 1.** The generally accepted firefly luciferase bioluminescence mechanism.

In this study, we focused on modeling the preoxidation stage of firefly bioluminescence. To describe it, a joint approach combining classical molecular dynamics simulations and hybrid quantum mechanics/molecular mechanics (QM/MM) calculations was used. We found that this process consists of two steps. The first involves the cleavage of the P<sub>α</sub>-O<sub>β</sub> bond in ATP, associated with the formation of a bond between the O<sub>11</sub> atom of luciferin and the P<sub>α</sub> atom of ATP. This reaction step proceeds via association mechanism. The second step involves the deprotonation of C<sub>1</sub> atom of luciferyl adenylate, which is coupled with the proton transfer to either His244 or PPi. Thus, a reactive species is formed, that is able to activate the oxygen molecule in the upcoming oxidation reaction.

## References

[1] *Chem. Soc. Rev.* **2016**, 45, 6048

[2] *Chem. Rev.* **2022**, 122, 13207

## Acknowledgements

This work was supported by the Russian Science Foundation (project #22-13-00012). We acknowledge the use of supercomputer resources of the Joint Supercomputer Center of the Russian Academy of Sciences and the equipment of the shared research facilities of HPC computing resources at Lomonosov Moscow State University.

# HEAT CAPACITY OF ALKALY METALS AND AMMONIUM IONS SOLUTIONS IN MIXED SOLVENTS N-METHYLPYRROLIDONE–WATER AT 298.15 K

*Bondarev V.P.,<sup>1</sup> Demidov M.P.,<sup>1</sup> Arngold V.A.,<sup>1</sup> Selina V.A.,<sup>1</sup> Novikov A.N.<sup>1</sup>*

<sup>1</sup>Novomoskovsk Institute, Mendeleev University of Chemical Technology, Novomoskovsk, Russia  
Student

[bondarev-02@mail.ru](mailto:bondarev-02@mail.ru)

In this work we continue systematic studies of the thermodynamic properties of solutions based on an aprotic dipolar solvents [1,2]. Data on the properties of the N-methylpyrrolidone (MP)–water system [3] are evidence of specific interactions of its components with the formation of associates of the composition MP·2H<sub>2</sub>O, which should influence the properties of ternary systems.

The heat capacities  $C_p$  of solutions of potassium, rubidium and ammonium iodides in a mixed solvent N-methylpyrrolidone (MP)-water were measured with high accuracy over the entire range of compositions at 298.15 K. Heat capacity measurements were performed on the LKB 8700 calorimetric unit with an error of  $2 \cdot 10^{-3}$  J/g·K.

On the basis of the data obtained, the apparent molar values of  $\Phi_c$  were calculated, extrapolating the concentration dependences of which to the state of infinite dilution the standard partial molar heat capacities  $\overline{C}_{p,2}^0$  of KI, RbI and NH<sub>4</sub>I in the mixed solvent MP-water at 298.15 K were determined. The values  $\overline{C}_{p,2}^0$  are listed in Table.

Table. Standard partial molar heat capacities  $\overline{C}_{p,2}^0$  J/mole·K of KI, RbI and NH<sub>4</sub>I in the mixed solvent MP-water at 298.15 K

$\overline{C}_{p,2}^0$ , J/mole·K	$X_{MP}$						
	0,00	0,10	0,33	0,50	0,75	0,90	1,00
KI	-130	-109	-24	17	63	72	74
RbI	-144	-124	-26	18	76	87	85
NH <sub>4</sub> I	-69	-76	12	58	110	121	104

As follows from the data in the table, compared with alkali metal halides, where the values increase monotonously, for NH<sub>4</sub>I the dependence on the composition of the mixed solvent is extreme: at low concentrations of MP, a minimum is observed, and at high concentrations a maximum. In the entire range of compositions of the MP-H<sub>2</sub>O mixture, NH<sub>4</sub>I values are higher than alkali metal halides, and the inversion of values occurs with a lower MP content. This indicates the complex nature of intermolecular interactions in the studied solutions, which is significantly influenced not only by the properties of the MP-water binary system, but also by the structural behavior of the ammonium ion. More valuable information about interparticle interactions in the studied solutions is provided by the values of the standard partial molar heat capacities of individual ions  $\overline{C}_{p,i}^0$ . To separate the values  $\overline{C}_{p,2}^0$  into ionic components, the literature data on iodide ion in MP and MP-water mixtures [4,5] and the condition of additivity of partial molar quantities were used. The value  $\overline{C}_{p,i}^0$  is represented as the sum of four contributions: electrostatic, cavity formation, structural changes in the solvent and specific ion-solvent interactions. Based on experimental data and model representations, the contribution values are calculated. The dependence of the obtained values on the composition of the mixture is discussed in connection with the structure of the mixed solvent.

### References

- [1] Novikov A. N., Doronin Ya. I., Rakhmanova P. A. *Russ. J. Phys. Chem. A.* **2018**, 92, 1438-1441  
 [2] Novikov A. N., Doronin Ya. I., Vasilev V. A., Rakhmanova P. A. *Russ. J. Phys. Chem. A.* **2018**, 92, 1641-1643  
 [3] Zaichikov A.M. *Russ. J. Struct. Chem.* **2006**, 76,660-667  
 [4] Novikov A.N., Vasilev V.A. Lenina O.F. *Russ. J. Phys. Chem. A.* **2007**, 81, 1947-1953  
 [5] Novikov A.N. *Russ. J. Phys. Chem. A.* **2011**, 1664-1671

### Acknowledgements

This work was supported by the Ministry of Science and Higher Education of the Russian Federation scientific project of the "Laboratory of Ion Materials" (LIM), no. FSSM-2024-0006.

# ENERGY BARRIERS OF THE BIGINELLI REACTION WITH THE CHIRAL INDUCTORS BASED ON 4-HYDROXYPROLINE

*Borodina O.S.*<sup>1</sup>, *Krasnostanov Y.S.*<sup>1</sup>, *Kuzovlev M.D.*<sup>1</sup>, *Ovchinnikova, I.G.*<sup>2</sup>, *Fedorova, O.V.*<sup>2</sup>,  
*Bartashevich E.V.*<sup>1</sup>,

<sup>1</sup>South Ural State University, Chelyabinsk, Russia;

<sup>2</sup>Postovsky Institute of Organic Synthesis, Ural Branch of the Russian Academy of Sciences,  
Yekaterinburg, Russia;

Postgraduate student

[borodinaos@susu.ru](mailto:borodinaos@susu.ru)

In the Biginelli reaction involving chiral 4-hydroxyprolinium inducers, modeling of the *pro-S* : *pro-R* ratio of pre-reaction complexes using the balanced metadynamics method showed that the greatest contribution to stereoselectivity comes from the stages of interaction of the 4-hydroxyprolinium inductor with benzaldehyde and the ternary adduct of the 4-hydroxyprolinium inductor - acetoacetic ester - benzaldehyde with urea. At the same time, it is not just one step that leads to the observed enantiomeric excess of *R*-dihydropyrimidinone, but a combination of them, which, in turn, depends on the form of the chiral inductor [1]. To identify the relationship between the contributions of the pre-reaction stage and kinetic factors, we solved the problem of assessing the reaction barriers at the stage of interaction between urea and the ternary adduct of 4-hydroxyproline inductor - acetoacetic ester - benzaldehyde in the *E,Z* configuration, which was previously identified as the most energetically probable [3].

4-hydroxy-2-[(*o*-methoxyphenyl)carbamoyl]pyrrolidinium was studied as a 4-hydroxyproline inducer. The IRC reaction paths were calculated using DFT methods at the B3LYP/6-31G(d,p) level [2]. The approach of urea was carried out from different diastereotopic sides of the ternary adduct (scheme 1). Structures located in energy minima obtained in metadynamics were used as pre-reaction complexes leading to different stereoisomers (figure 1).

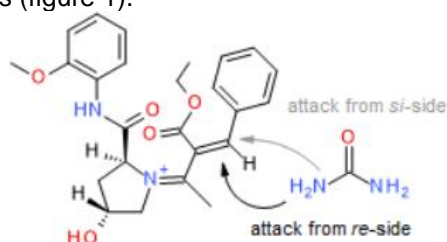

**Scheme 1.** Bond C-N formation when urea approaches to the *re* and *si* prochiral center in the ternary adduct

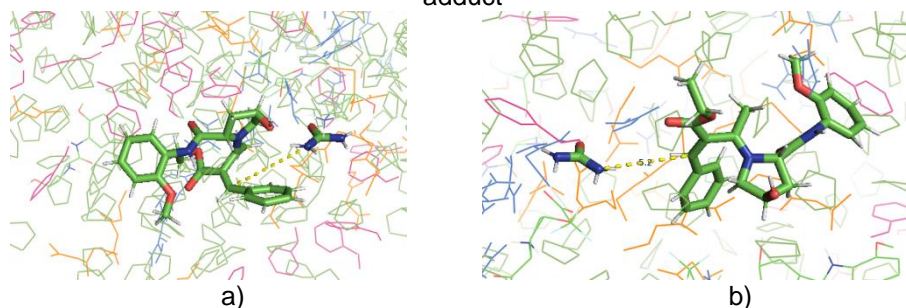

**Figure 1.** *Pro-S* (a) and *pro-R* (b) pre-reaction complexes of urea and ternary adduct

The forming diastereomeric transition states are close in energy, and the small difference in the reaction barriers is formed due to the non-equivalence of the approach from the *re* and *si* sides of the prochiral center of the ternary adduct due to different H-bonds.

## References

- [1] *Mendeleev Commun.* **2018**, 28, 4, 357–358.
- [2] *Acc. Chem. Res.* **1981**, 14, 12, 363–368.
- [3] *Russ. Chem. Bull.* **2023**, 72, 8, 1767-1780.

# CARBON NANOTUBES ADSORPTION MODIFICATION WITH CHITOSAN ACCORDING TO SUPERCOMPUTER SIMULATION

*Bunyaev V.A.<sup>1,2</sup>, Sinolits A.V.<sup>2</sup>, Badun G.A.<sup>1</sup>*

<sup>1</sup> Moscow State University, Moscow, Russia

<sup>2</sup> Vernadsky Institute of Geochemistry and Analytical Chemistry of RAS, Moscow, Russia

Associate scientist

[bunyaev@geokhi.ru](mailto:bunyaev@geokhi.ru)

Single-walled carbon nanotubes (SWCNTs) demonstrate outstanding mechanical and electric properties that emerges interest in their applications in creating new materials for implanted devices. The significant postpone on the way for their application is their impact on living cells so they are usually essentially modified for biomedical purposes. One of the ways to increase SWCNTs biocompatibility is their surface modification with biopolymers. Although the most reliable route to modify SWCNTs surface with biopolymer is covalent grafting, adsorption modification is the simplest technique. Chitosan is a mucopolysaccharide that is well-known for its high biocompatibility properties. Adsorption modification considers non-covalent interaction between chitosan and SWCNTs that is weaker than covalent one but allows creating of smart complexes that are able to release their constituents so it is of great interest to study the mechanisms of non-covalent adsorption interactions between chitosan and SWCNTs. The composition of chitosan-SWCNTs adsorption complex has been quantified earlier with the use of [<sup>3</sup>H]chitosan [1] but mechanism of interaction and structure of the complex were unclear.

We have carried out supercomputer simulation of chitosan-SWCNT interaction in aqueous media with molecular dynamics. Chitosan was taken in form of a linear molecule consisting of 50 glucosamine fragments, 33 of them were carrying NH<sub>2</sub>-group in protonated form while other 17 were N-acetylglucosamine according to the real structure of polysaccharide with deacetylation degree of 66%. SWCNT was simulated as C<sub>1960</sub>F<sub>148</sub> with fluorine content of 6% (mol.). Surface of SWCNT model was available for all functional groups of polysaccharide. Pre-optimization of the models under consideration was carried out with molecular mechanics in CambridgeSoft ChemBio3D software in force field FFMM94. Partial charges of atoms were calculated with semi-empirical quantum chemistry simulation in MOPAC2016 software with the method PM7 with the Eigenvector-Following algorithm. The following simulation was carried out with Gromacs software using topology files of chitosan and SWCNT prepared with *gmx x2top* command. Simulation time of each trajectory was 200 ns; simulation area was a cube with a side length 27 nm; solvent molecule quantity was 617223, solvent type was water (TIP3P); force field was OPLS-AA. We were considering four different starting conformations of polysaccharide respectively to SWCNT surface. Thermostat (300 K) and barostat (1 bar) were of Berendsen algorithm and of the pair Nose-Hoover & Parrinello-Rahman.

Adsorption complexes of chitosan with SWCNT were simulated. H atoms of NH<sub>2</sub>- of chitosan and OH-groups of D-glucosamine fragments are involved in H-bonds with fluorine atoms of SWCNT surface. Hydrophobic interactions make even more significant contribution in the whole binding energy as non-polar CH<sub>3</sub>-group in N-acetyl and non-polar –CH- fragments in glucosamine cycles of chitosan interact with non-polar surface of SWCNT consisting of sp<sup>2</sup>-hybridized carbon atoms thus strongly attaching chitosan to SWCNT surface. The obtained complex structure may be referred to as a capsule capping SWCNT from the both ends. No significant difference between Berendsen and Parrinello-Rahman thermostats and barostats was noticed for simulation of this complex.

## References

[1] *Surface phenomena in dispersed systems*. **2023**, 1, 159

## Acknowledgements

The research is carried out using the equipment of the shared research facilities of HPC computing resources at Lomonosov Moscow State University.

This work was supported by State Assignments of Vernadsky Institute of Geochemistry and Analytical Chemistry of Russian Academy of Sciences.



# INTERROGATING BRIDGING HYDRON TUNNELING IN THE COUPLED HOMOCONJUGATED ANIONS OF SELENIC ACID

*Chakalov E.R.<sup>1</sup>, Tolstoy P.M.<sup>1</sup>, Resnati G.<sup>2</sup>*

<sup>1</sup> St. Petersburg State University, St. Petersburg, Russia

<sup>2</sup> Polytechnic University of Milan, Milan, Italy

2<sup>nd</sup> year PhD student

[st086266@student.spbu.ru](mailto:st086266@student.spbu.ru)

The quantum nature of hydron, namely, proton and deuteron, plays profound role in hydrogen transfer processes and hydrogen bonding (H-bonding). A firm cooperation between experimental and theoretical methods is required in order to achieve deep insight into both phenomena. H-bond mediated acid-base interactions of coupled homoconjugated selenate anions with nitrogen-containing heterocycles in hybrid compounds are challenging, as they represent key features for their appealing physicochemical properties [1-3].

We have studied novel H-bonded complexes of selenic acid with pyridine and quinoline in the crystalline state using density functional theory calculations with periodic boundary conditions. Particularly, we have addressed the synchronous (coherent) process of the bridging hydron tunneling within the asymmetric double-well and single-well one-dimensional potentials of the SeO–L···OSe bonds (L = H/D transfer process) in order to assess the influence of the isotope mass on the bridging particle localization and dynamics essential for charge relay and H-bond cooperativity effects (Fig. 1). Since the zero-point energy depends on the nuclear masses, one observes an isotope dependence of the H-bond distances, *i.e.* the H-bond strength is modified as evidenced by the shapes of squares of the zero-point vibrational wave functions or hydron density distribution functions,  $\Psi_0(\text{H})^2$  and  $\Psi_0(\text{D})^2$ . We conclude that, within the quasi-adiabatic approximation envisaging the continuous change of the overall O...O ( $r_1 + r_2$ ) distance upon the hydron transfer process, the intertwined zero-point energy effect and anharmonic O–L stretching mode coupling gives rise to a quantum-mechanically induced strengthening of the SeO–L···OSe bonds, *i.e.* quantum correction to the “classical” equilibrium geometries.

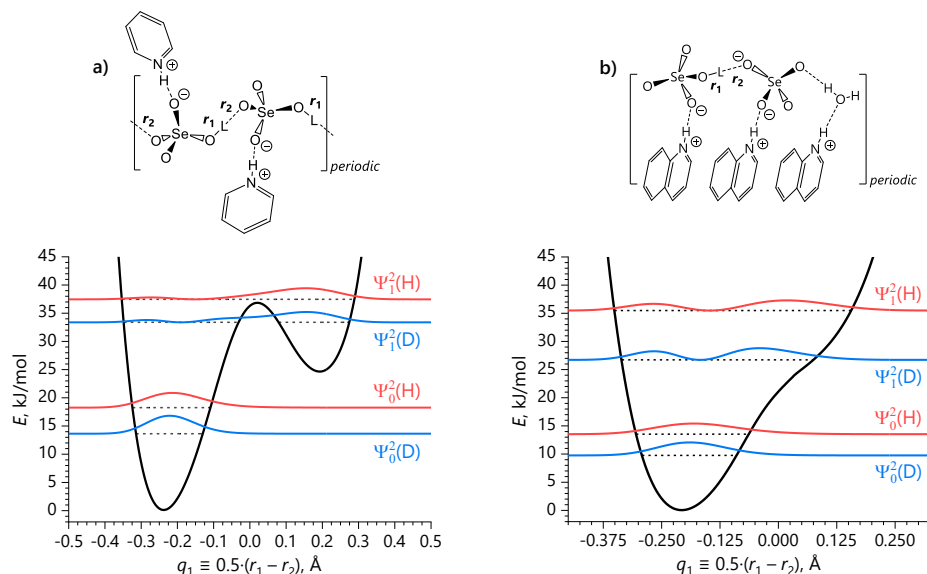

**Figure 1.** Coherent motion of SeO–L···OSe bridging hydrons along (a) the infinite HB chain and (b) two links of the HB chain according to the quasi-adiabatic pathway represented by 1D potentials.

## References

- [1] *J. Mol. Struct.* **2014**, 1074, 602
- [2] *J. Mol. Struct.* **2019**, 1198, 126854
- [3] *J. Mol. Struct.* **2024**, 1305, 137809

## Acknowledgements

This work was supported by the Russian Science Foundation (Project RSF No 23-13-00095).

# QUANTUM CHEMICAL MODELING OF MECHANICAL PROPERTIES OF CARBON AND NITRIDE BORON NANOTUBES

*Cherezova P.Y.<sup>1</sup>, Porsev V.V.<sup>1</sup>*

<sup>1</sup> St. Petersburg State University, St. Petersburg, Russia  
Student  
[st097978@student.spbu.ru](mailto:st097978@student.spbu.ru)

The structural, electronic and mechanical properties of various nanotubes, in particular carbon and boron nitride nanotubes, are being actively studied. These nanotubes are isoelectronic to each other and have the same hexagonal structure, so they can be compared with each other.

Carbon nanotubes have been the object of research since the 1990s [1]: progress in their synthesis and their unusual properties have determined the relevance of their theoretical studies. BN nanotubes also have unique properties due to thermal and chemical stability compared to carbon nanotubes [2]. Recent advances in the synthesis of boron nitride nanotubes have increased the attention of researchers to them. Studying the mechanical properties of these nanotubes is especially important because they are particularly stiff materials and can be used as a component of composite materials. Previous theoretical studies of the mechanical properties of nanotubes have been limited by the effect of axial strain on the nanotubes. Torsional and bending deformations were practically not taken into account [3].

Within the framework of an approach based on line symmetry groups, we quantum-chemically studied changes in the structural, energetic and electronic properties of single-walled carbon and BN nanotubes under axial and torsional deformations [4]. The Crystal17 program was used for the study [5].

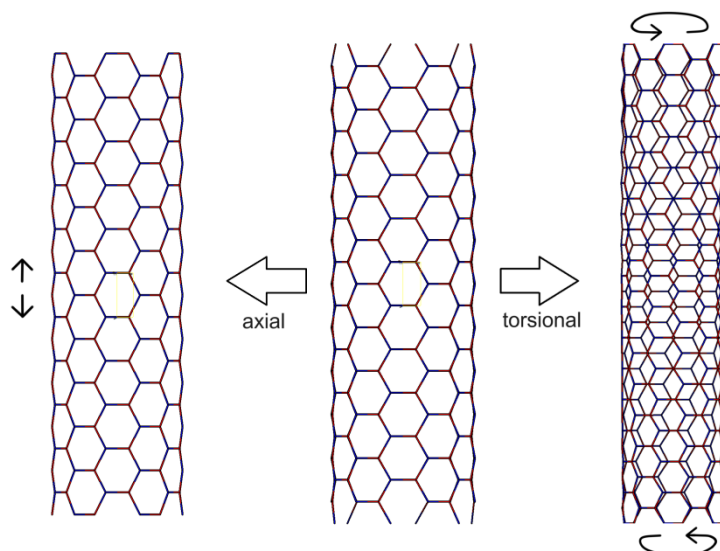

**Figure 1.** Axial and torsional deformations of single-walled BN nanotubes.

## References

- [1] E.B.Barros et al. *Phys. Rep.* **2006**, 431, 261.
- [2] A.O.Maselugbo et al. *J. Mat. Res.* **2022**, 37, 4438.
- [3] P.N.Dyachkov et al *J. Inorg.Chem.* **2021**, 66, 750.
- [4] V.V.Porsev et al. *Com. Mat. Sci.* **2022**, 203, 111063.
- [5] R.Dovesi et al. *WIREs Comput. Mol. Sci.* **2018**, 8, e1360.

## Acknowledgements

The authors highly appreciate the assistance of Saint Petersburg State University Computer Center for the high-performance calculations.

## CATALYTIC PYROLYSIS OF METHANE - PROMISING METHOD FOR PRODUCING HYDROGEN AND STRUCTURED CARBON MATERIAL

*Chudakova M.V., Andreev D.S., Popov M.V., Korovchenko P.A.*

As part of the commitments under the Paris Agreement on Climate Change, industrial leaders around the world are currently actively developing and implementing technologies for producing, storing and transporting hydrogen.

The main industrial method of hydrogen production today is the steam conversion of methane, however, due to the significant release of carbon dioxide (up to 13.7 kg of CO<sub>2</sub> per 1 kg of H<sub>2</sub>), this technology does not fit into the modern paradigm of low-carbon energy. Further use of steam conversion of methane leads to the need for the use of CCUS technologies (carbon capture, utilization and storage) and the search for alternative ways to produce hydrogen.

The decarbonization process in the oil and gas industry system implements a reduction in its carbon intensity and energy in general, including by reducing natural gas emissions. Scientific and technical transformation is accompanied by fundamental changes in the strategic priorities of oil and gas companies.

According to the Energy Strategy of the Russian Federation for the period up to 2035 (Decree of the Government of the Russian Federation No. 1523-r), one of the priorities is the development of the hydrogen production and consumption sector, including through the monetization of methane. From the set of key measures aimed at solving this task, it is worth highlighting the need to develop domestic low-carbon hydrogen production technologies.

Currently, there are several directions for the development of technologies for producing hydrogen from methane:

- Thermal;
- Catalytic;
- Plasma chemical;
- In liquid media (melts of metals/salts).

Among the various methods of hydrogen production, the catalytic pyrolysis of methane deserves special attention due to three important factors. The catalytic nature of the reaction ensures high energy efficiency of the process, which allows the process to be carried out at relatively low temperatures. The absence of greenhouse gas and CO<sub>2</sub> emissions makes the process attractive from an environmental point of view. As an additional product, a structured carbon material is formed during the catalytic decomposition of methane, which is a sought-after product with high added value. Given the rapid development of the carbon materials market, the production of carbon with specified properties is a very attractive direction.

Among transition metals, nickel-containing catalysts exhibit the greatest activity in the process of methane decomposition, and also demonstrate high quality of the resulting carbon. The main problem with the use of such catalysts is their rapid deactivation due to the formation of encapsulating carbon covering the active areas of the catalyst.

The introduction of promoters into the catalyst composition, the selection of the catalyst synthesis method and the process conditions such as pressure, temperature and volumetric velocity can significantly influence the main indicators of the process. The addition of promoters makes it possible to stabilize the active centers of the catalyst, provide the necessary dispersion, which forms a sufficient number of active centers on the surface of the carrier.

The paper considers nickel-containing catalysts promoted with copper, cobalt, and potassium. The critical influence of the catalyst formation method (salt fusion method, solution combustion method, impregnation method) on methane conversion and hydrogen yield is shown.

It has been demonstrated that the proposed approach allows obtaining nanosized carbon fibers, while their structure and size can be controlled by selecting the process conditions.

## MODELING ADSORPTION OF CONTAMINANTS FROM SOLUTION BY PARTICLES OF MICROPLASTICS

*Davydov N.A.*<sup>1</sup>, *Victorov A.I.*<sup>1</sup>

<sup>1</sup> St. Petersburg State University, St. Petersburg, Russia  
[nikita.davidov02@yandex.ru](mailto:nikita.davidov02@yandex.ru)

In recent years, the problem of plastics in the ocean has become one of the most significant challenges of the global ecology [1]. Plastics debris undergo fragmentation under various impacts resulting in formation of microplastics – small particles that have been found not only in sea water all around the globe, but also in fish, other animals and human body. It is not clear yet whether these particles have negative impact on human health. However, there is a suggestion that microplastics may adsorb contaminants from water, transfer and release them into the organisms. Although some experimental work has been performed in this field, there is no generally accepted theory of this and related phenomena. Hence, it is of interest to develop and test a theoretical model of adsorption of contaminants on the particles of microplastics.

In this work, the microplastics particle is represented as a solid core covered with dense polymer brush. This picture is akin to the model of a copolymer micelle with the glassy core in the strong segregation limit. Therefore, we may employ the theoretical approach for the polymer brushes and micelles by Semenov [2] and by Zhulina, Birshtein, et al. [3]. The self-consistent field acting on the polymer chain in such systems depends parabolically on the distance from the grafting surface. The Euler-Lagrange equations that control the equilibrium distribution of species in the brush can be solved analytically in few cases. Regrettably, there is no analytical solution of these equations for the case of bad solvent containing an additive.

In the original theory [2,3] the interactions are treated in the Bragg-Williams approximation, hence this theory is not suitable for systems with specific interactions. To consider possible specific interactions with contaminants, we decorated the theory by taking into account correlations in the Guggenheim quasi-chemical approximation. To solve the Euler-Lagrange equations numerically, we developed an algorithm and a code in C#. This code gives the concentration profiles of solvent, contaminant and the polymer depending on the interaction parameters, the size of the contaminant molecules, the elasticity of the polymer, and the geometry of the micro/nano-plastics particle.

Since the brush in a bad solvent is typically in a globular state, it is necessary to take into account the third and the higher order virial coefficients. This is done by introducing an interaction parameter that depends on the polymer concentration, which makes it possible to describe phase separation inside the polymer brush [3]. For bad solvents, the profiles obtained in our work demonstrate two microphases in the brush: a polymer-rich microphase located next to the core of the particle, and a solvent-enriched microphase in contact with the surrounding solvent. We tested our approach for a number of model systems and compared the results with available experiment and simulation data.

Within our model, the contaminant's concentration profile depends on a number of factors, including the quality of solvent and the presence of specific interactions between the contaminant and microplastics: this profile may gradually increase to the outside of the particle but it may also show a maximum inside the brush.

### References

- [1] *Sci. Rep.* **2018**, 8, 4666
- [2] *Zh. Eksp. Teor. Fiz.* **1985**, 88, 1242-1256
- [3] *J. Chem. Phys.* **2003**, 119 (20), 10977–10988

## AB INITIO MODELING OF HELICAL PEPTIDES

*Domnin A.V.*<sup>1</sup>, *Solovev Y.V.*<sup>2</sup> *Evarestov R.A.*<sup>1</sup>

<sup>1</sup> St. Petersburg State University, St. Petersburg, Russia

<sup>2</sup> M.M. Shemyakin and Yu.A. Ovchinnikov Institute of Bioorganic Chemistry of the Russian Academy of Sciences, Moscow, Russia

Researcher

[a.domnin@spbu.ru](mailto:a.domnin@spbu.ru)

The study of peptide helices using quantum chemistry methods plays a vital role in in-depth understanding of their properties and structure. These helical structures are essential for living organisms and may be responsible for various biological processes. The comprehension of these processes at the molecular level may facilitate the development of novel methodologies for the treatment of diseases, the creation of more efficacious drugs, and even the generation of new materials with enhanced properties. Helical peptides are promising targets for the fabrication of new materials with distinctive properties, due to their capacity to form stable three-dimensional structures (aggregates) [1] and interact with metals [2]. These characteristics render helical peptides useful for the development of biocompatible materials, nanotechnology and drugs. Consequently, the study of helical peptides has broad prospects in both science and industry.

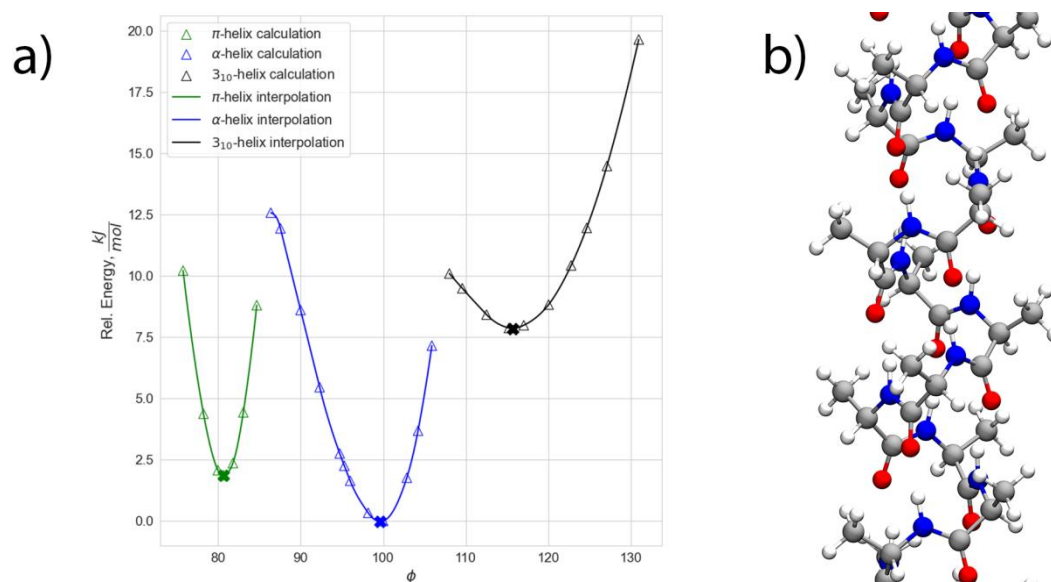

**Figure 1.** a) Obtained dependence of the relative energy on the torsion angle; b) Structure of polyalanine in the obtained energy minimum.

In this work, we have conducted a comprehensive theoretical analysis of the structure and properties of helical peptides. We have constructed torsion curves from which it is possible to determine with high accuracy the structural and electronic characteristics corresponding to the energy minimum. Additionally, we have obtained data on the transition of  $\pi$ - to  $\alpha$ - helices. All calculations have been carried out with full symmetry consideration, by means of using the theory of line groups symmetry [3]. Extensive work has been carried out on the choice and verification of the computational scheme. The obtained data not only correlate with the available experimental data, but also extend our understanding of the properties of these structures.

### References

- [1] *Protein Pept Lett.* **2019**, 26(2), 88–97.
- [2] *J. Am. Chem. Soc.* **2021**, 143, 42, 17316–17336
- [3] *J. Phys. A:* **1978**, 11, 2133

### Acknowledgements

This research received no external funding. The authors highly appreciate the assistance of Saint Petersburg State University's "Computer Center SPbU" for high-performance computing.

# KINETICS OF THE HYDROLYSIS REACTION OF SODIUM BOROHYDRIDE ON A HIGHLY DISPERSED NICKEL CATALYST

*Donina M.V.*<sup>1</sup>, *Esefiyeva T.Yu.*<sup>1</sup>, *Magzhanov R.K.*<sup>1</sup>, *Yarovaya O.V.*<sup>1</sup>

<sup>1</sup> D. Mendeleev University of Chemical Technology of Russia, Moscow, Russia

Postgraduate student

[donina.m.v@muctr.ru](mailto:donina.m.v@muctr.ru)

In this paper, the possibility of using highly dispersed nickel obtained by chemical reduction of nickel salts with sodium borohydride as a catalyst is studied. Metallic nickel was obtained by reducing NiCl<sub>2</sub> [1]. The rate constant is calculated and the order of the hydrolysis reaction of sodium borohydride on synthesized particles is determined. Comparative characteristics of nickel catalysts of different structure and composition are given, the advantage of the obtained nickel powder over catalysts of similar structure is substantiated, as well as the prospects for using the obtained particles as a catalyst for the hydrogen production reaction. Kinetic studies were carried out using the volumetric method. Hydrogen is released in the NaBH<sub>4</sub> hydrolysis reaction, the measured volume of which was further recalculated for the concentration of borohydride at each moment.

The authors of the article [2] studied the kinetics of the hydrolysis reaction of sodium borohydride on particles of the Ni-B structure and used the following equation:

$$r = k_1[MBH_4][MOH] = \frac{k_1 K_{BH_4}[BH_4^-]K_{OH}[OH^-]}{(1 + K_{BH_4}[BH_4^-] + K_{OH}[OH^-])^2},$$

where  $k_1$  is the rate constant of the rate-limiting step in the process mechanism; M is the active center of the catalyst; KBH<sub>4</sub>, KOH are the adsorption constants of borohydride and hydroxide ions on the surface of the catalyst. It was found by carrying out experiments that this equation is applicable to our system (Fig. 1).

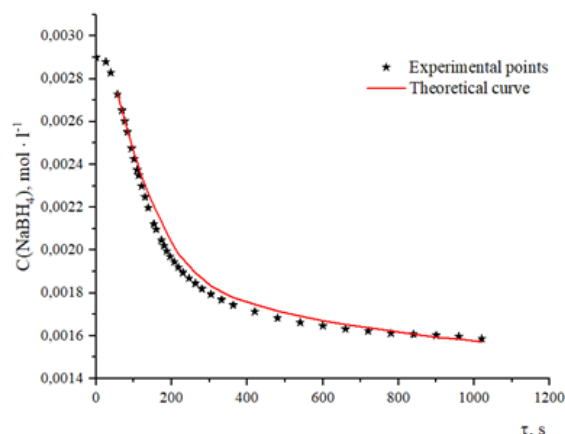

**Figure 1.** Comparison of experimental and theoretical data on changes in NaBH<sub>4</sub> concentration during hydrolysis reaction on synthesized nickel particles

Based on the results of the study and calculations, the following conclusions were made:

The synthesized highly dispersed nickel catalyst has high catalytic activity. The calculated rate constant is  $2,545 \cdot 10^{-4} \text{ mol}^{0.75} \cdot \text{l}^{0.75} \cdot \text{s}^{-1}$  – an order of magnitude higher than. Also, it is necessary to consider the concentration of OH<sup>-</sup> ions in the system in the case of analyzing the kinetics of the process on the obtained nickel particles. The proposed method of manufacturing of the catalyst is quite simple in execution, but at the same time it allows to obtain nickel, which can intensify the reaction of borohydride hydrolysis to a level that allows it to be used for producing of hydrogen. The values of the constants and orders of the borohydride hydrolysis reaction will allow calculating the constants of nucleation and particle growth rate during the synthesis of the catalyst, which, ultimately, will open way to optimization of the reaction conditions.

## References

- [1] XXI Mendeleev Congress on General and Applied Chemistry. Book 2a. Chemistry and technology of materials: Abstracts. **2019**, 2, 270.  
[2] *Journal of Power Sources*. **2014**, 268, 596-603.

# EFFECT OF SINGLE NUCLEOTIDE POLYMORPHISMS ON STABILITY AND FUNCTION OF HNRNPA2/B1

Dutta K.<sup>1</sup>, Kravtsov V.<sup>1</sup>, Oleynikova K.<sup>2</sup>, Ruzov A.<sup>2</sup>, Skorb E.V.<sup>1</sup>, Shityakov S.<sup>1</sup>

<sup>1</sup> Infochemistry Scientific Center, ITMO University, Russia

<sup>2</sup> Institute of Bioengineering, Research Center of Biotechnology of the Russian Academy of Sciences, Moscow, Russia  
Postdoc, PhD  
[kdutta@itmo.ru](mailto:kdutta@itmo.ru)

A crucial component of RNA metabolism, antiviral responses, and m6A recognition is heterogeneous nuclear ribonucleoprotein A2/B1 (hnRNP A2/B1) [1]. Overexpression of HNRNPA2/B1, abnormal RNA levels, and m6A depositions are evident in cancer [2]. This study focuses on two major nonsynonymous single nucleotide polymorphisms (nsSNPs) F66L and E92K in HNRNPA2/B1 (Scheme 1). According to our structural study these mutants show lower stability, with E92K likely to undergo destabilizing post-translational methylation. In addition, our extensive examination of 44,239 tumor samples from the COSMIC database reveals that amino acid position 92 within HNRNPA2/B1 has the second-highest mutation frequency, which is specifically linked to lung and breast cancers. The stability and functioning of HNRNPA2/B1 are significantly impacted by the nsSNP at position 92, as demonstrated by the experimental results that supports our theoretical study [3]. Considering the dysregulation that has been seen in cancer, specifically with regard to m6A disposition, RNA levels, and HNRNPA2/B1 overexpression, examining F66L and E92K nsSNPs may provide important information for developing epigenetic drugs that target RNA metabolism in cancer.

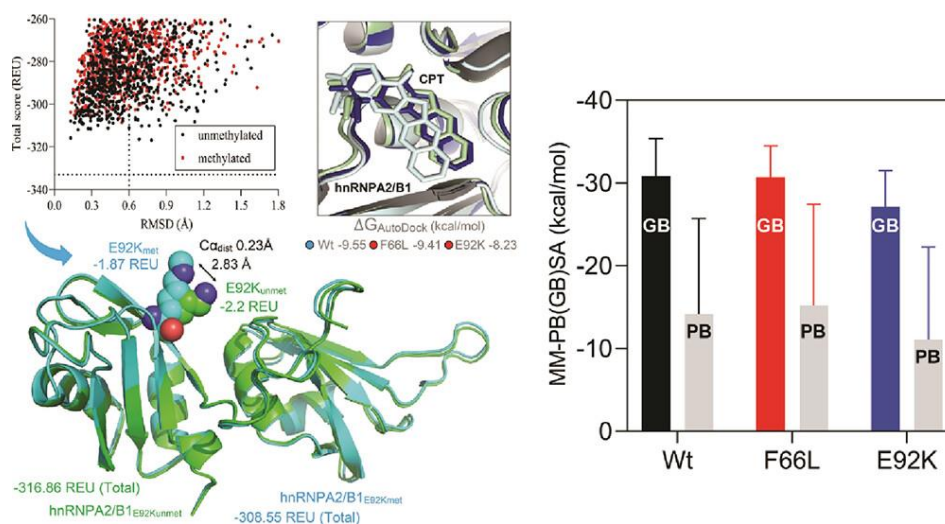

**Scheme 1.** Outlook of the study.

## References

- [1] *Cell*. **2015**, 6, 1299
- [2] *RNA Biol*. **2014**, 6, 755
- [2] *ACS Omega*. **2024**, 9, 5485

## Acknowledgements

This work was supported by grant from the Russian Science Foundation (RSF), Russia, no. 263 22-65-00022. This research received financial support from the Government of the Russian Federation through the ITMO Fellowship and Professorship Program. Additionally, partial funding for KO and AR was provided by the Ministry of Higher Education of the Russian Federation under Project number 1220411001149-7.

# ELECTRON BUFFER EFFECT: GUIDING PYRIDINIUM YLIDES AND NITROALKENES TOWARD [3+2] OR [4+1] PRODUCTS

Daniil A. Rusanov,<sup>1,5</sup> *Khadizha Dzhiblavi*,<sup>2,3,5</sup> Nikita A. Kuznetsov,<sup>3,5</sup> Vadim I. Malyshev,<sup>3</sup> Ana Popović-Bijelić,<sup>4</sup> Alexander V. Samet,<sup>3</sup> Victor V. Semenov,<sup>3</sup> Maria V. Babak,<sup>1</sup> Michael G. Medvedev<sup>2,3</sup>

<sup>1</sup>Drug Discovery Lab, Department of Chemistry, City University of Hong Kong, Hong Kong, Hong Kong SAR

<sup>2</sup>Infochemistry Scientific Center, ITMO University, Lomonosova Street 9, Saint-Petersburg, Russia

<sup>3</sup>N. D. Zelinsky Institute of Organic Chemistry, Russian Academy of Sciences, Moscow, Russia

<sup>4</sup>Faculty of Physical Chemistry, University of Belgrade, Belgrade, Serbia

<sup>5</sup>Equally contributing authors

Student

[xdzhiblavi@gmail.com](mailto:xdzhiblavi@gmail.com)

In our study the influence of substituents on the process of [3+2] and [4+1]-cycloaddition between the nitroalkenes and pyridinium ylides was investigated. Using a combination of the theoretical and experimental methods, we gained insights into the mechanistic intricacies of the reaction and established that the [3 + 2] cycloaddition between pyridinium ylides and 1-arylnitroalkenes can be diverted toward [4 + 1] annulation in a process shown on Scheme 1.

We observed that a group of substituents behaves in a way that clashes with the classical understanding of electronic effects. The substituents which contain an aromatic ring or a different unsaturated hydrocarbon fragment have the ability to both donate and withdraw electrons depending on the demands of the connected atoms, which invokes the concept of the electron buffers<sup>1</sup>. To the best of our knowledge, this concept was never applied to the regular organic substituents.

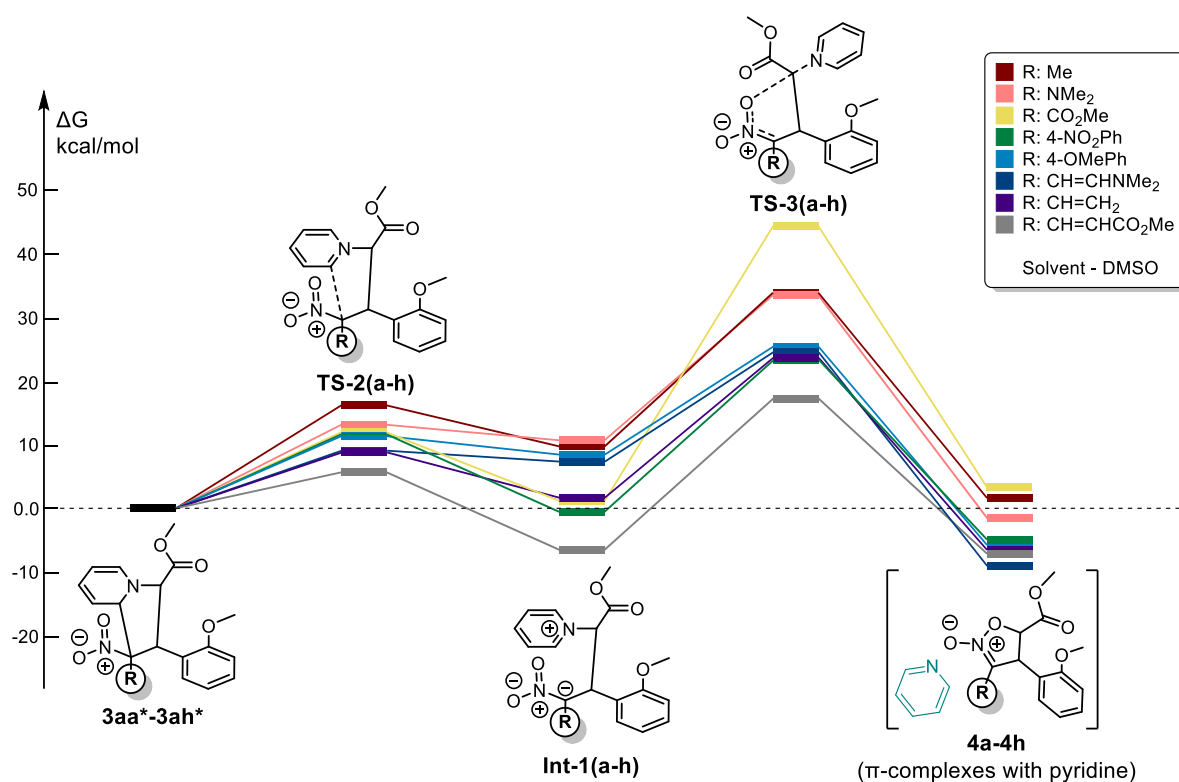

**Scheme 1.** The calculated energy profile of the [3+2] → [4+1]-product transformation. The entries with non-buffering substituents (Me, NMe<sub>2</sub>, CO<sub>2</sub>Me) show higher values of activation energy. The buffer effect only influences the energies of transition states.

## References

[1] *Journal of the American Chemical Society* 2024, 146, 2033-2042.



# DESIGN OF APTAMER SEQUENCES WITH PREDETERMINED AFFINITY TO SMALL MOLECULES USING ARTIFICIAL INTELLIGENCE

*Eremeeva M.A., Krasovskaya Z.S., Serov N.S., Patra C.K.*<sup>1</sup>

<sup>1</sup> ITMO University, St. Petersburg, Russia

Master Student

[eremeeva\\_maria@scamt-itmo.ru](mailto:eremeeva_maria@scamt-itmo.ru)

Aptamers are short, single-stranded RNA/DNA sequences that have the ability to bind to specific molecular targets with high specificity and affinity. This makes them a promising solution for creating sensitive sensors that can quickly and reliably detect unwanted compounds, for example in food products<sup>[1]</sup>. However, the development of aptamers using traditional methods, such as SELEX, often requires significant time and resource costs, limiting their application in diagnostics.

To overcome this problem, a new approach is proposed based on the use of artificial intelligence and machine learning methods to predict aptamer sequences based on the physicochemical and structural properties of molecular targets.

In the initial phase of our project, we developed a comprehensive database of unique aptamer-target pairs by compiling data from scientific articles and existing databases. After excluding unsuitable targets like proteins, lipids, and viruses, we curated a dataset consisting of around 1000 aptamer-target pairs with associated dissociation constant ( $K_d$ ) values. Most of the aptamers in the database are canonical, and from the data collected manually, 80% of all sequences relate to DNA, while the aptamer databases predominantly contain data on RNA. This diverse sourcing approach enabled us to create a dataset that is balanced in terms of nucleic acid type.

Descriptors were computed for each pair to characterize the nucleotide composition using the repDNA<sup>[2]</sup> and repRNA<sup>[3]</sup> packages, as well as rdkit<sup>[4]</sup> and Mordred<sup>[5]</sup> descriptors to represent small molecules. During the initial screening of machine learning models to predict  $pK_d$  values, separate datasets divided by nucleic acid type were analyzed. Models based on tree-based and boosting algorithms demonstrated the highest accuracy, with a coefficient of determination  $R^2 > 0.65$  achieved.

In future steps, it is planned to use generative neural networks to create high-affinity and selective aptamers for given molecules. The transition from the experimental SELEX method to digital screening and subsequent validation of the best candidates will significantly speed up the production process.

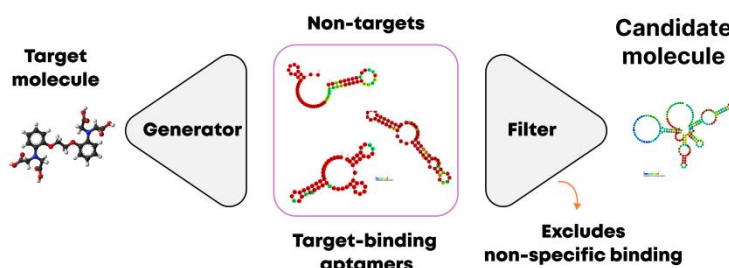

**Scheme 1.** Scheme of aptamer candidate generation

## References

- [1] Cho, Eun Jeong, Joo-Woon Lee, and Andrew D. Ellington. "Applications of aptamers as sensors." *Annual review of analytical chemistry* 2 (2009): 241-264.
- [2] Liu, Bin, et al. "repDNA: a Python package to generate various modes of feature vectors for DNA sequences by incorporating user-defined physicochemical properties and sequence-order effects." *Bioinformatics* 31.8 (2015): 1307-1309.
- [3] Liu, Bin, et al. "repRNA: a web server for generating various feature vectors of RNA sequences." *Molecular Genetics and Genomics* 291 (2016): 473-481.
- [4] Landrum, Greg. "RDKit: A software suite for cheminformatics, computational chemistry, and predictive modeling." *Greg Landrum* 8.31.10 (2013): 5281.
- [5] Moriwaki, Hiroto, et al. "Mordred: a molecular descriptor calculator." *Journal of cheminformatics* 10 (2018): 1-14.

## Acknowledgements

This work was supported by the NIRMA ITMO

# KINASE SELECTIVITY PROFILING USING 3D PHARMACOPHORES AND GRAPH NEURAL NETWORKS

*Ereshchenko A.V.*<sup>1</sup>, *Evteev S.A.*<sup>2</sup>, *Malyshev A.S.*<sup>2</sup>, *Ivanenkov Y.A.*<sup>2</sup>

<sup>1</sup>FRC «Computer Science and Control» RAS, Moscow, Russia

<sup>2</sup>P.Hertsen Moscow Oncology Research Institute, Moscow, Russia

Graduate student

[ereshchenko.alexey@gmail.com](mailto:ereshchenko.alexey@gmail.com)

Kinase profiling is an essential step in both hit identification and selectivity evaluation. However, *in vitro* testing of big compound libraries is costly and time-consuming, but computational approach can be a solution. Here we present a new *in silico* method for activity profiling of potential kinase inhibitors that utilizes the SMILES information to calculate physico-chemical properties, molecular fingerprints, and ensemble of 3D-pharmacophores of a small molecule.

The method operates via an ensemble of 3D pharmacophore representations. 3D pharmacophores are obtained based on conformations generated using an in-house method. The algorithm processes 3D pharmacophores with a graph neural network as a connected graph. Then, the responses of the network on the ensemble are averaged and concatenated with molecular fingerprints [1] and 11 calculated physico-chemical descriptors. The resulting vector is then passed to series of linear layers. Resulting model predicts the probability of a molecule to inhibit ( $IC_{50} < 1 \mu M$ ) each of the 75 kinases it has been trained on. Scheme 1 demonstrates the process.

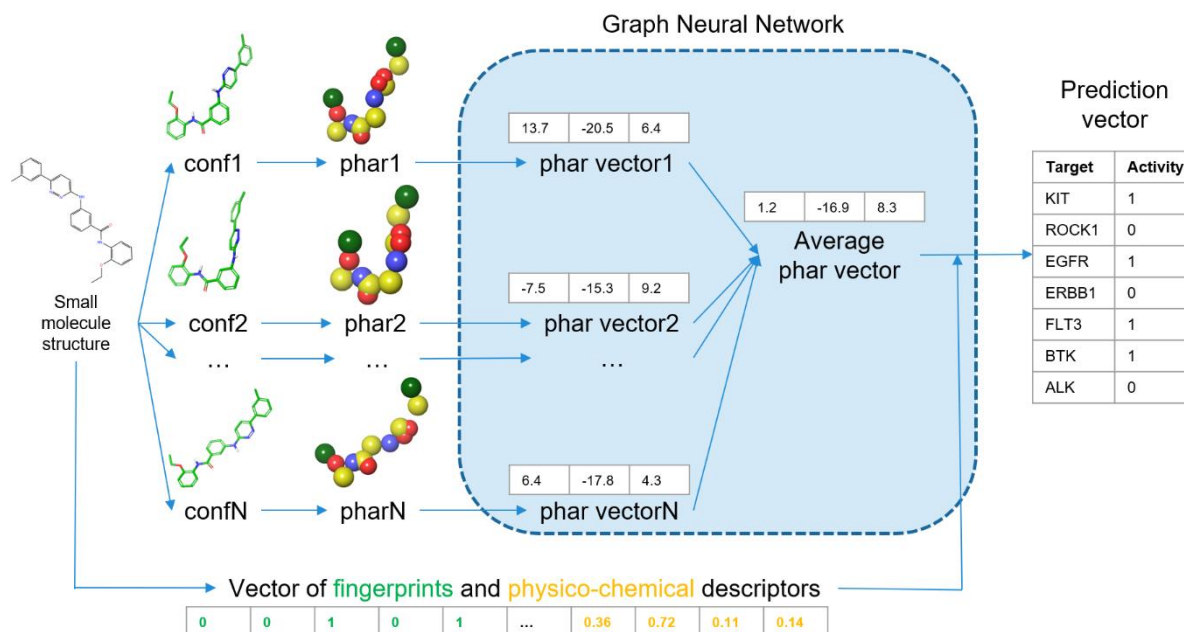

**Scheme 1.** Pipeline of kinase profiling algorithm.

To examine the performance of the method and the impact of the addition of 3D features, a baseline gradient boosting model (using CatBoost[2]) was trained, using only physico-chemical descriptors and Morgan fingerprints. The proposed approach has shown to be more accurate on the independent test set compared to the baseline model, with macro average F1 measure of 0.45 across all targets, compared to 0.38 F1 measure demonstrated by the CatBoost model. The work shows that combination of diverse features and processing it using graph neural networks can be a promising solution for *in silico* kinase selectivity profiling.

## References

- [1] Morgan HL. The generation of a unique machine description for chemical structures—a technique developed at chemical abstracts service. *J Chem* **1965** Doc 5:107–113.
- [2] Prokhorenkova L. et al. CatBoost: unbiased boosting with categorical features // *Advances in neural information processing systems*. – **2018**. – T. 31.

MOLECULAR DYNAMICS STUDY OF CO<sub>2</sub> AND CH<sub>4</sub> GAS HYDRATE  
NANOCLUSTERS IN CONFINEMENT

*Evsyukov I.V., Sizova A.A.*

St. Petersburg State University, St. Petersburg, Russia  
Student  
[st107444@student.spbu.ru](mailto:st107444@student.spbu.ru)

Methane hydrates are known to be a potential alternative source of natural gas. In-depth understanding of hydrate behavior is desirable for the improvement of hydrate-based processes. Gas hydrates naturally occur in sedimentary soils, where they are typically confined in various porous media. Therefore, the investigation of gas hydrates in confinement can be a valuable contribution to the development of advanced industrial and environmental technologies.

Molecular dynamics simulations in *NVT*-ensemble were used to study the decomposition of carbon dioxide and methane hydrates in amorphous silica and carbon slit pores. The stability of spherical nanoclusters of CO<sub>2</sub> and CH<sub>4</sub> hydrates (sl structure) with a diameter of ca. 3 nm surrounded by supercooled water was considered at temperatures from 190 K to 270 K. Simulation of hydrates without confinement was also carried out for use as a reference.

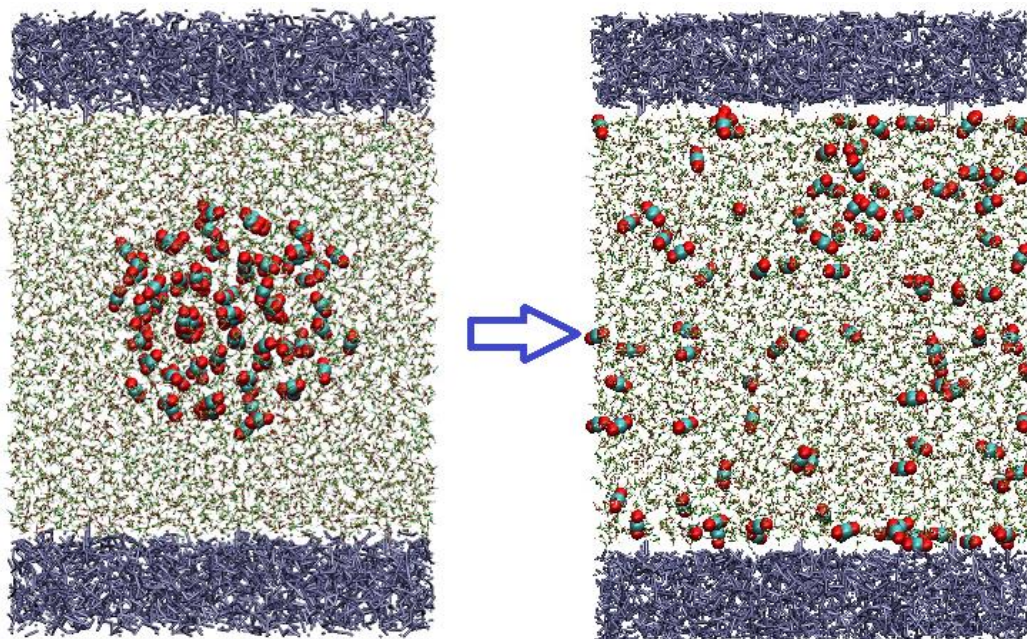

**Figure 1.** Snapshots of CO<sub>2</sub> hydrate in carbon pore before (190K) and after (270K) its decomposition.

The melting point of each gas hydrate was determined based on the observed changes in thermodynamic, structural (Fig. 1) and dynamic properties, such as the potential energies of hydrates, radial distribution functions and diffusion coefficients for the gases and hydrate water. The distribution of gas molecules in pores was examined by means of partial density profiles. Another useful descriptor is the  $F_{4\phi}$  order parameter, which allows one to assign any H<sub>2</sub>O molecule to either liquid water or hydrate water [1], thus providing an accurate description of gas hydrate decomposition process. Based on the simulation results, the molecular mechanism of confinement effect on the stability of gas hydrate nanoclusters can be proposed.

#### References

[1] *Fluid Phase Equilib.* **1996**, 116, 326–32

## VISCOSITY OF DEEP EUTECTIC SOLVENTS: LINER AND NONLINER MODELS

*K.A. Fedorov<sup>1,2</sup>, S.D. Galibin<sup>1,3</sup>*

<sup>1</sup>G. A. Krestov Institute of Solution Chemistry of the Russian Academy of Sciences, Russia

<sup>2</sup>Ivanovo State Power Engineering University, Russia

<sup>3</sup>Ivanovo State University of Chemistry and Technology, Russia

Student

[kir.fed200004@mail.ru](mailto:kir.fed200004@mail.ru)

In recent years, there has been an increasing focus on green technology and the advancement of safer, more efficient, and environmentally friendly processes. This trend has resulted in a surge of publications highlighting eco-friendly engineering principles, particularly concerning the use of solvents that are safe for both humans and the environment. Deep eutectic solvents (DESs) are seen as a promising alternative to traditional organic solvents, which are known for their detrimental effects on the environment.

These DESs are created by combining hydrogen bond acceptors and hydrogen bond donors to form an eutectic system with a lower melting point than its individual components and a lower temperature than an ideal liquid mixture. The viscosity of DESs plays a critical role in their potential applications and process design. Despite their potential advantages, DESs face challenges such as low diffusion coefficients, slow gas absorption rates, and low electrical conductivity due to their high viscosity. Viscosity is a crucial parameter for engineering calculations and scaling up DES applications, affecting factors like equipment dimensions, pump and heat exchanger efficiency, and the viability of mixing, separation, and product utilization.

In the study, regression models were developed to forecast the temperature-dependent dynamic viscosity of DESs. A dataset containing 3440 data points representing 252 unique DESs was utilized to train machine learning models. The preferred model was constructed using the CatBoost algorithm with CDK molecular descriptors. The models underwent evaluation using both random and artificial data divisions, with outcomes indicating that only a rigorous separation of data can effectively demonstrate the predictive power of the model. Moreover, it was noted that models developed solely on mixture data outperformed those developed with pure mixture components included.

A quantitative structure-property relationship model for viscosity prediction in DES based on choline chloride was also established. By building a linear model from this data set using four molecular descriptors, satisfactory predictive performance was achieved, with  $R^2 = 0.82$ , RMSE = 0.25, and AARD = 14.6%. Finally, the viscosities of two new choline chloride-based DESs were measured, and the predictive ability of the models was confirmed. We have created an online version of the model: <http://chem-predictor.isc-ras.ru/ionic/des/>.

### **Acknowledgements**

The financial support of the work was provided by the Russian Science Foundation № 23-13-00118, <https://rscf.ru/project/23-13-00118/>

## CLASSICAL FORCEFIELD FOR SELENIUM OXYANIONS

*Glushak A.A.<sup>1</sup>, Smirnov G.S.<sup>1</sup>*

<sup>1</sup> International Laboratory for Supercomputer Atomistic Modelling and Multi-Scale Analysis, HSE University, Moscow, Russia

Student

[aaglushak@edu.hse.ru](mailto:aaglushak@edu.hse.ru)

Selenium is one of the health-important natural occurring elements. Considered as an important micronutrient in low doses, it is becoming dangerous in higher doses [1]. Also, <sup>79</sup>Se radioactive isotopes are considered as a major dose-determining radionuclide which can affect the biosphere over geological timescale [2]. They are highly solvable in water and, therefore, highly mobile. There are many experimental studies on selenium oxyanions adsorption and solubility [3,4]. At same time, computational studies are limited, as there are no well-known classical forcefields developed for these molecules and mostly ab initio methods were previously applied to these molecules [5,6].

In this study we have developed a classical forcefield for  $\text{SeO}_4^{2-}$ ,  $\text{SeO}_3^{2-}$ ,  $\text{HSeO}_3^-$  oxyanions, comparable with the ClayFF potential [7]. This potential will allow to better study selenium mobility in aqueous solutions, as well as better understand its interaction with sorbents at the nano-scale.

The initial approximation for the force constants and charges were taken from double-hybrid DSD-PBEP86 density functional theory calculations with a SMD implicit solvent. The initial values were used in classical molecular dynamics calculations for further optimization, based on an algorithm described by Williams and Carbone [8]. The solvation energy estimation and Se-O bonds length were chosen to fit the force field parameters.

### References

- [1] *Environ. Sci. Technol.* **2018**, *52*, 3, 1624-1632
- [2] *Talanta.* **2007**, *72*, 3, 1166-1171
- [3] *Dalton Trans.* **2014**, *43*, 6315
- [4] *Hydrometallurgy.* **2020**, *191*, 105231
- [5] *J. Phys. Chem. A.* **2010**, *114*, 8948-8960
- [6] *Chem. Phys. Lett.* **2014**, *595-596*, 226-229
- [7] *J. Phys. Chem. C.* **2021**, *125*, 17573-17589
- [8] *J. Chem. Phys.* **2015**, *143*, 174502

### Acknowledgements

This research was funded by the HSE Basic Research Program.

# INFLUENCE OF THE DEGREE OF PREPARATION OF COMPONENTS, INTERACTING WITH NICKEL-BASED ALLOYS

*Gordeeva J.F.<sup>1</sup>, Filatov E.S.<sup>2</sup>*

<sup>1</sup> Ural State Mining University

<sup>2</sup> Ural Federal University named after the first President of Russia B.N. Yeltsin

Applicant

[Gordeeva@m.ursmu.ru](mailto:Gordeeva@m.ursmu.ru), [julia100990@inbox.ru](mailto:julia100990@inbox.ru)

The relevance of this work lies in the choice of Hastelloy G35 alloy as a material for the manufacture of the product, which is closest to molten salts, in this case, potassium chloroaluminate.

The purpose of this work is to prevent the process of damage to equipment operating in a potassium chloroaluminate environment.

The task was to prepare the parts and create conditions for working with the alloy.

Using IR spectroscopy, differential scanning calorimetry (hereinafter referred to as DSC) and thermogravimetry, corrosion-active impurities causing increased corrosion of equipment materials were identified in the initial reagent potassium chloroaluminate [1]. The potassium chloroaluminate melt was purified using compact aluminum obtained from foundry waste from aluminum production [2].

Thermodynamic calculations show that the presence of oxygen and moisture is unacceptable in the reaction medium. It is necessary to purify potassium chloride from oxygen and moisture impurities by repeatedly flushing the system with purified argon [3].

Maintain the synthesized melt of chloroaluminate in contact with high-purity aluminum metal at a temperature of 350 – 380 °C for a certain time [3].

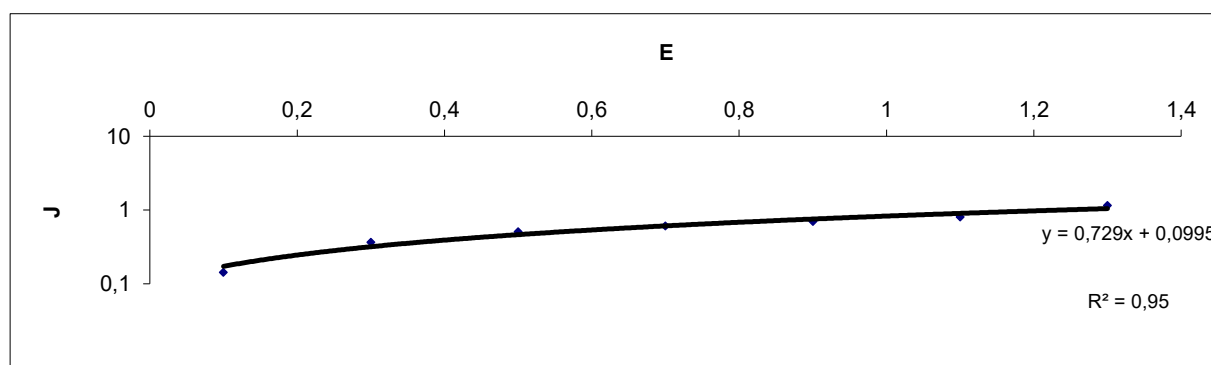

**Scheme 1.** Primary polarization current-voltage curves for calculating corrosion currents of structural materials (Hastelloy G35) in a sodium chloroaluminate melt depending on temperature.

The graph shows that when the anodic current is turned on, corrosion occurs, which then reaches a plateau, where slow corrosion occurs and this plateau is called passivation. It has been established that the values of the stationary potentials of the G35 alloy practically do not change with temperature, remaining constant [2].

The constancy of dependent equilibrium potentials affects and stationary potentials are combined with time, indicating the stability and sustainability of the system as a whole, if it is isolated from external external factors, such as air or moisture entering the system, large local overheating and other effects [2].

## References

- [1] L.E. Ivanovsky, V.A. Khokhlov, G.F. Kazantsev, Physical chemistry and electrochemistry of chloroaluminate melts, ed., "Nauka", Moscow. 1993, 249
- [2] E.S. Filatov, J.F. Gordeeva, Studies of the corrosion activity of  $KAlCl_4$  melt using physicochemical analysis methods, Anti-corrosion practice, 2019, 24/4, 59-66 (in Russian)
- [3] Kudyakov V. YA. Sposob prigotovleniya rastvora khloraluminata kaliya dlya razdeleniya khloridov tsirkoniya i gafniya. Patent RF, no. 2431700, 2011

## Acknowledgements

The authors thank the Priority-2030 program for infrastructural support.

# MOLECULAR MODELING OF BOVINE SERUM ALBUMIN IMPRINTED IN THE PRESENCE OF MULTIPLE MYCOTOXINS MOLECULES: INTERACTIONS AND BINDING MODE INSIGHTS

*Ilicheva P.M.<sup>1</sup>, Pidenko P.S.<sup>1</sup>, Burmistrova N.A.<sup>1</sup>*

<sup>1</sup> Saratov State University, Saratov, Russia

Oral presentation, PhD Student

[iichevapm@gmail.com](mailto:iichevapm@gmail.com)

Molecularly imprinted polymers play a very important role in all areas of contemporary technology and science. Besides mainstream, molecular imprinting based on man-made synthetic polymers or silica-imprinted materials, proteins can be considered as a matrix to prepare artificial molecular recognition systems. Nowadays, imprinted proteins (IPs) can be used as biosynthetic recognition element in immunoassay. They are characterized by lowered affinity and specificity toward their target compared with antibodies, however, their production is significant cheaper and faster [1,2]. Moreover, IPs-based test systems can detect a number of analytes at a level comparable to commercially available antibody-based test systems. Despite the obvious promise of their application, no structural information about IPs formation to assist researchers to precisely control their properties. In this regard, computational modelling is a powerful tool for studying mechanisms behind the imprinting process, that provides enormous opportunities for the rational design of IPs.

The technique of IPs creation is based on reversible changes in the three-dimensional structure of a protein induced by noncovalent interactions with a ligand in mild denaturing conditions such as pH change. After these changes, a protein shows altered binding properties, with enhancement of its sorption capacity and affinity of template molecules. Theoretical molecular modelling in the present study explores the origins of altered binding properties of protein matrix at the level of atomistic interactions prior to IPs formation.

In this work, various molecular modeling approaches, including molecular docking and molecular dynamics, were used as a tool for the retrospective mechanistic analysis. Bovine serum albumin (BSA) was used as a matrix for generation of specific binding cavities with mycotoxins (naturally occurring toxicants, produced by several species of fungi). Combination of experimental and theoretical techniques was used for more exhaustive characterization of the structural changes in the protein matrix. The results from this study provide insights into IPs formation and may form the basis for further prospective design of IPs.

## References

- [1] *Anal. Chim. Acta* **2018**, *1040*, 99-104
- [2] *Biotechnol. Rep.* **2016**, *11*, 12-17

## Acknowledgements

This work was supported by the Russian Science Foundation (project No 22–16–00102).

# PREDICTION OF PHOTOPHYSICAL PROPERTIES OF ORGANOMETALLIC COMPOUNDS USING MACHINE LEARNING ALGORITHMS

*Ilin E.A.*<sup>1</sup>, *Filatov V.A.*<sup>2</sup>

<sup>1</sup>Faculty of Chemistry, Lomonosov Moscow State University, Moscow 119991, Russia

<sup>2</sup>Science Center, SkyLab AG, 1066 Lausanne, Switzerland

[ilin.eg.2000@gmail.com](mailto:ilin.eg.2000@gmail.com)

Recently, a broad field of study has been developed in the realm of chemistry, focusing on the development of luminescent materials. For determining the suitability of a molecule as a phosphor, the knowledge of its photophysical and photodynamic properties, including excitation wavelength and fluorescence wavelength, is considered essential. Currently, the demonstration of machine learning applications is limited exclusively to organic molecules devoid of metal atoms. The objective of this research is to devise a model that can predict the photodynamic properties of organometallic complexes.

A combination of a 12x12 Coulomb matrix, which describes the coordination environment of most metal atoms, Morgan FingerPrints, which describe the ligand environment, and persistence Barcodes, which describe the topology of the complex as a whole, was used to encode organometallic compounds. Additionally, good results were shown by the SLATM descriptor.

Acceptable predictive ability was shown by gradient boosting CatBoost; the best results were obtained with neural network architectures such as CNN and RNN, which were found capable of predicting the photodynamic properties of organometallic phosphors with high accuracy. The resulting metrics to predict absorption and emission wavelengths are shown in Figure 1. For comparison, the results of quantum chemical modeling of absorption wavelengths at the TD-DFT/PBE0-D3BJ/def2-tzvppd/CPCM(Acetonitrile) level in the Orca software package are presented.

As a result, machine learning models that are capable of predicting photodynamic properties at the level of quantum chemical modeling and higher for organometallic compounds were able to be created.

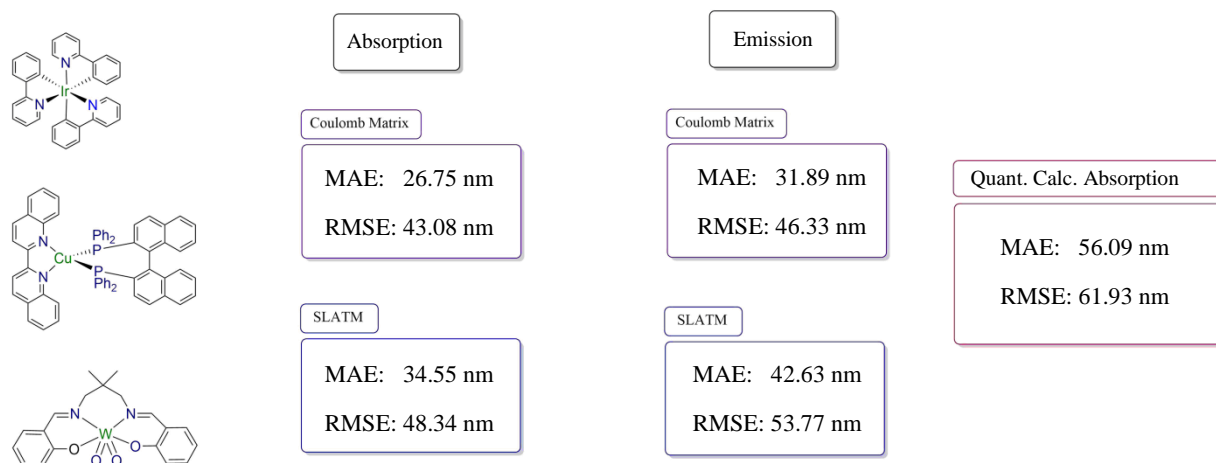

**Figure 1.** Photophysical properties prediction metrics.

## Acknowledgements

The work was supported of the non-profit Foundation for the Development of Science and Education "Intellect".

The code of the work and examples of the dataset used are available at the link: [https://github.com/Yagr49/Photocatalyst\\_NN](https://github.com/Yagr49/Photocatalyst_NN).



# THERMAL, SOLVATION AND QUANTUM EFFECTS IN MODELING OF HYDROGEN BONDS SPECTRAL PROPERTIES

*Kaplanskiy M.V.,<sup>1</sup> Tolstoy P.M.,<sup>1</sup> Tupikina E. Yu.<sup>1</sup>*

<sup>1</sup> St. Petersburg State University, St. Petersburg, Russia

Master student

[mark2402@mail.ru](mailto:mark2402@mail.ru)

NMR spectroscopy is the bread and butter of any researcher aiming to characterize non-covalent interactions, such as hydrogen bonds. Combined with quantum-chemical calculations <sup>1</sup>H NMR spectroscopy provides valuable information about strength and geometry of hydrogen bonds in disordered media such as soft matter and solutions.[1] However, there is a little sense in a direct comparison of the experimental spectroscopic parameters and computed ones by stationary electronic structure methods. The latter takes into account only indirect solvent effects by implicit models or at least considers explicit solvent molecules in the first coordination sphere. Moreover, real solutions are highly dynamic, and observed chemical shifts or spin-spin coupling constants in NMR spectra are ensemble averages of the system configurational space at a finite temperature. At the same time common practice in quantum chemistry is the approximation of the whole configurational space by only one stationary point and totally ignore quantum properties of proton, such as ability for tunneling.

In our work we test a computational protocol that takes into account explicit solvation effects and quantum corrections to the hydrogen bond potential in which protons move (Scheme 1). We considered several hydrogen-bonded model complexes for which experimental NMR spectroscopic data are available. Using molecular dynamics techniques, we investigated configurational spaces of the complexes and compute average NMR spectroscopic parameters for direct comparison with experiment.

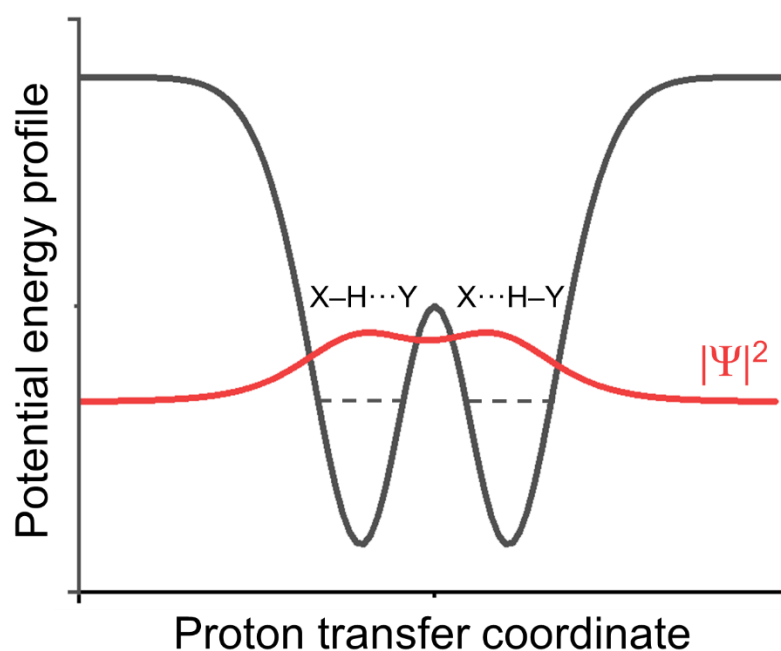

**Scheme 1.** Proton transfer double-well potential energy profile (black curve) and the corresponding proton density distribution (red curve).

## References

[1] Tolstoy, P. M., Tupikina, E. Yu. IR and NMR Spectral Diagnostics of Hydrogen Bond Energy and Geometry. *Spectroscopy and Computation of Hydrogen-Bonded Systems*, **2023**, 345-407

## Acknowledgements

This work was supported by the Russian Science Foundation (project No 24-73-10155).

IN SILICO SCREENING OF AGGREGATIVE BEHAVIOR MODIFIERS  
FOR HYDROCARBON/WATER SYSTEMS IN HYDROPHOBIC CONFINEMENT

*Kirillov M.V., Sizov V.V.*

St. Petersburg State University, St. Petersburg, Russia

Student

[st075539@student.spbu.ru](mailto:st075539@student.spbu.ru)

The aggregative behavior of immiscible liquids, such as hydrocarbons and water, can be controlled by addition of surfactants. However, many common surfactants tend to accumulate near the liquid-liquid interface, while the aggregative behavior in confinement is heavily influenced by the presence of the solid-liquid interface. Therefore, specially designed surface-active substances are desirable for efficient control over the properties of the systems under investigation. On the practical side, the studies of such systems can provide a valuable contribution to the development of enhanced oil recovery techniques.

In the present work, we employ an *in silico* screening approach to search for efficient modifiers of aggregative behavior of immiscible liquids in confinement. Molecular dynamics simulations are carried out for *n*-decane/water systems confined in hydrophobic carbon pores and containing up to 10 vol.% of surface-active additives. These additives are represented by a series of polyalcohols and polyacids sharing a common aliphatic framework (*n*-octane).

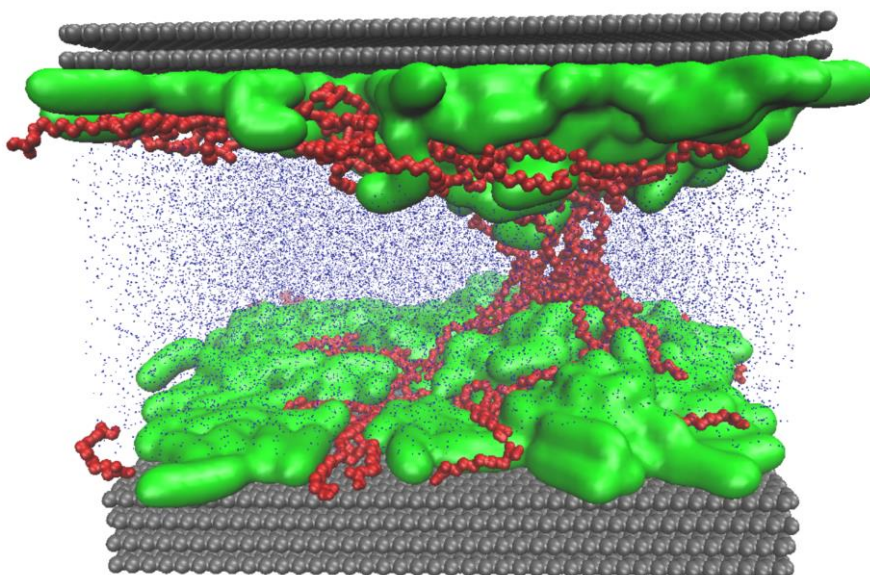

**Figure 1.** Simulation snapshot for 30:70 *n*-decane/water system containing 10 vol.% of sebacic acid. Color legend: carbonaceous surface is grey, *n*-decane is green, sebacic acid is red, water molecules are shown as blue dots.

Simulation data provide information on the aggregative behavior of the systems with surface-active substances. The behavior observed for these mixtures is compared to that for the systems without additives, which are used as reference. The distribution of the additives between both bulk liquids, the liquid-liquid-interface, and the solid-liquid interface provides another clue to the relative efficiency of the surface-active components in the role of aggregative behavior modifiers. The analysis of computational data provides an overall evaluation of the applicability of oxygen-containing substances based on linear hydrocarbons and suggests possible means for optimizing their efficiency.

#### Acknowledgements

This work was supported by the Russian Science Foundation (grant No. 24-23-00528).

# MOLECULAR DYNAMICS SIMULATION OF SURFACTANT ASSYMETRICAL ADSORPTION AND INTERFACIAL TENSION

*Kissler T. Yu.<sup>1</sup>, Vanin A.A.<sup>1</sup>*

<sup>1</sup> St. Petersburg State University, St. Petersburg, Russia  
Student  
[st068571@student.spbu.ru](mailto:st068571@student.spbu.ru)

When choosing an effective surfactant, it becomes important to study the dependence of interfacial tension on the adsorption value, the so-called Gibbs adsorption isotherm. The molecular dynamics (MD) method can be used to study interfacial layers. MD allows one to obtain the structural characteristics of the formed monolayer, study dynamic processes, and calculate the interfacial tension in the system [1].

Due to three-dimensional periodic boundary conditions, there are two interfaces in the simulating system, each of which has its own adsorption value. Thus, there are a number of difficulties encountered when modeling heterogeneous systems containing surfactants. One of these problems is the transition of surfactant molecules from the interphase layer to the adjacent bulk phases; often this transition is accompanied by the formation of aggregates (micelles). This leads to a decrease in the actual adsorption value and to a difference in interfacial tension at the two interfaces. Modern studies do not take into account the asymmetry of adsorption values.

In the current work, molecular dynamic simulations of both anionic (SDS, CTAB) and nonionic ( $C_nE_m$ ) surfactants in two-phase water-dodecane system using the coarse-grained Martini 3.0 force field [2] are performed. We propose a methodic for recalculating of adsorption and interfacial tension values in the cases of the surfactant transition from interface the adjacent bulk phases. In the case of uneven distribution of surfactants between two interfacial layers, the values of interfacial tensions on each layer were obtained by calculating the local stress tensor (Fig. 1). Interfacial tension values were recalculated by using the third-party software GROMACS-LS [3]. The Gibbs adsorption isotherms for all the surfactants have been recalculated, and significant changes in the type of graph for the dependence of surface tension on adsorption have been observed (Fig. 2).

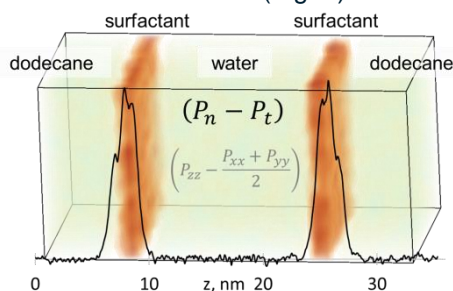

**Figure 1.** The difference of normal ( $p_n$ ) and tangential ( $p_t$ ) local pressure in the system: yellow color corresponds to the bulk phases, brown color corresponds to the localization of the interfacial layers.

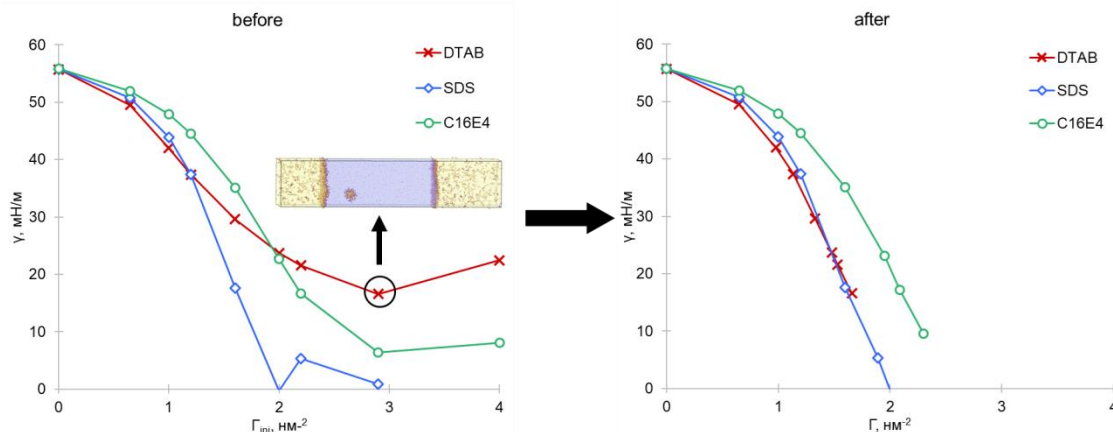

**Figure 2.** Gibbs adsorption isotherm calculated by simple and advanced methods.

## References

- [1] *Theor. Chem. Acc.* **2017**, 136(21)
- [2] *Nature Methods* **2021**, 18, 382
- [3] *Phys. Rev. Lett.* **2015**, 114, 258102

# ACCURATE AND EFFICIENT CONFORMER GENERATION OF DRUG MACROCYCLES WITH RING KINEMATICS INFORMED SAMPLING

*Krivoshchapov N.V.*<sup>1,2</sup>, *Medvedev M.G.*<sup>1,2</sup>

<sup>1</sup>N. D. Zelinsky Institute of Organic Chemistry, Russian Academy of Sciences, Russia

<sup>2</sup>Center for National Technological Initiative, Bauman Moscow State Technical University, Russia  
PhD student

[nikolai.krivoshchapov@gmail.com](mailto:nikolai.krivoshchapov@gmail.com)

Accurate prediction of all significant molecular conformers is a crucial step in many computational chemistry pipelines. As an example from *in silico* drug development, molecular docking requires exhaustive conformational ensemble for potential drug candidates to generate favorable ligand-receptor poses and, ultimately, identify the prime drug candidates [1]. However, conformational sampling of molecules with flexible cycles presents an even bigger challenge, since traditional random and systematic torsional searches are inefficient for cycles, whereas molecular dynamics-based methods have severely limited exploration due to kinetic trapping.

Inverse kinematics is a mathematical framework for enforcing geometric constraints on complex flexible systems, thus, can be employed for conformation space exploration of (poly)cyclic molecules [2]. Here, we introduce inverse-kinematics-based Monte Carlo with Refinement (MCR) algorithm (Scheme 1), which autonomously identifies rotatable dihedral angles in (poly)cyclic molecules and utilizes them to conduct comprehensive global conformational sampling. Our benchmarks demonstrate that MCR outperforms established methods such as MacroModel, CREST, and RDKit in terms of both speed and diversity of the resulting conformer ensembles. Furthermore, we show that MCR can quickly and accurately recover naturally occurring conformations of the majority of considered biologically-relevant macrocycles.

Overall, MCR solves the problem of broad conformational sampling of small- and middle-sized cyclic molecules, being able to quickly discover bioactive macrocycle conformations and those observed in crystal structures. In perspective, integration of MCR into various geometry prediction pipelines, e.g., molecular docking, crystal structure prediction or single-molecule conformation search, can supply task-specific algorithms with an extensive set of conformations that encapsulate essential molecular flexibility information. Thus, paving the way for more reliable and efficient computational biochemistry pipelines, crucial for expediting drug development *in silico* and advancing our understanding of complex cellular processes.

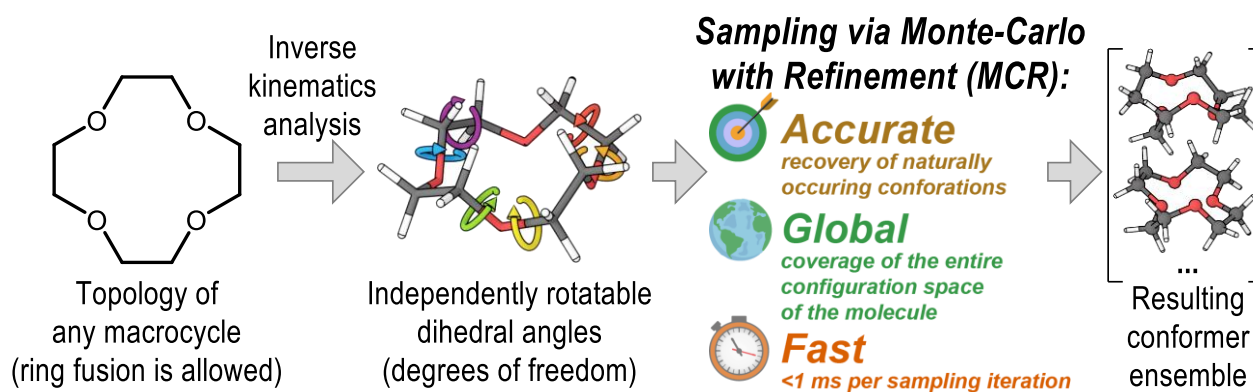

**Scheme 1.** Core concepts and advantages of the new Monte-Carlo with Refinement sampling algorithm.

## References

- [1] *Front. Pharmacol.* **2018**, 9, 923.  
[2] *WIREs Comput Mol Sci.* **2023**, e1690.

## Acknowledgements

This work was supported by the Russian Science Foundation (project No 22-73-10124).

# DYNAMIC OF NON-COVALENT INTERACTIONS DURING THE P–O BOND CLEAVAGE BY RIBONUCLEASE A

*Kruglov M.L.<sup>1</sup>, Kaplanskiy M.V.<sup>1</sup>, Tupikina E. Yu.<sup>1</sup>*

<sup>1</sup> St. Petersburg State University, St. Petersburg, Russia  
Student

[st106286@student.spbu.ru](mailto:st106286@student.spbu.ru)

In this work, the cleavage of the phosphodiester P–O bond in an RNA molecule by the enzyme ribonuclease A was investigated[1]. To study this process using computational chemistry, we performed geometry optimization, electron density topological analysis, PES scans, and simulations using molecular dynamics and metadynamics techniques. In this work, non-covalent interactions in the complex of ribonuclease A active center and phosphate substrate were detected and described quantitatively. It is shown that these non-covalent interactions play different roles – they are responsible for electron density or proton transfer processes, or keeping the substrate-enzyme complex together.

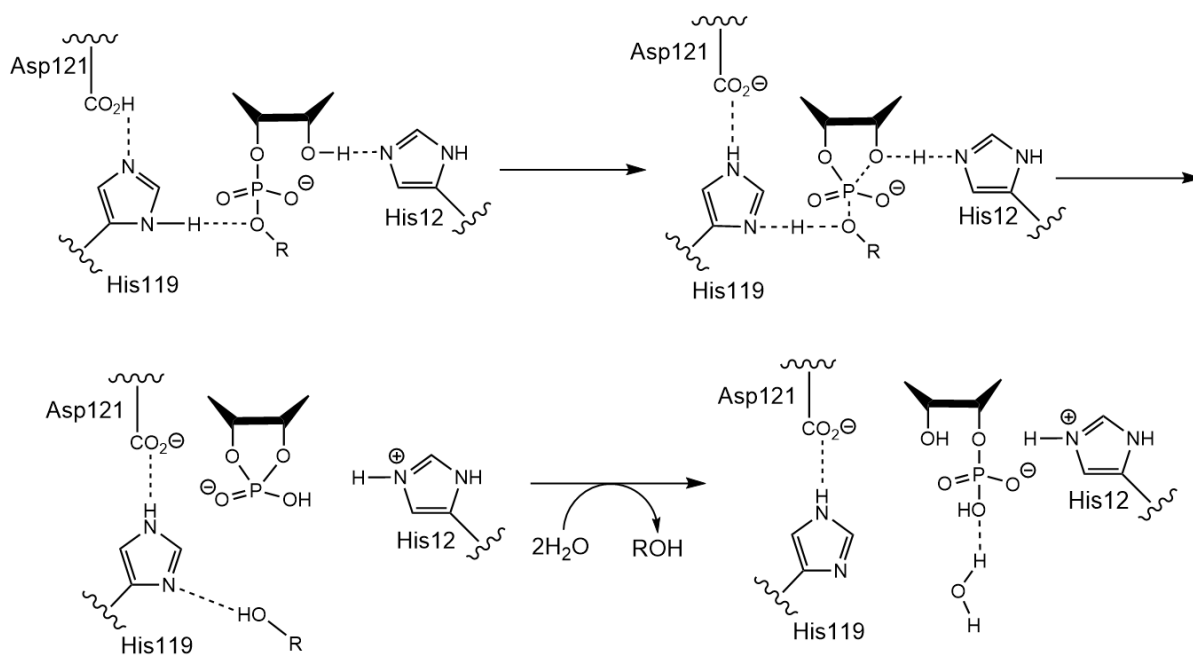

**Scheme 1.** Catalytic P–O bond cleavage mechanism.

Due to the detailed analysis of non-covalent interactions in the studied system, we were able to clarify the details of the generally accepted acid-base mechanism presented in Scheme 1[2]. It is worth noting that in our work we have discovered for the first time the existence of a chalcogen bond between the oxygen of the phosphate ligand and the nitrogen of His119, which plays a primary role in the electron density transfer from the phosphate.

## References

- [1] Chemical Reviews. **1998**, 98(3), 1045.
- [2] Biochimica et Biophysica Acta (BBA) – Proteins and Proteomics. **2015**, 1854(11), 1801.

## Acknowledgements

This work was supported by the RSF grant 22-73-00094. Research was carried out using computational resources provided by Resource Center "Computer Center of SPbU" (<http://cc.spbu.ru>)

# REACTIVITY OF I<sub>2</sub> TOWARDS PERFLUORINATED LEWIS ACIDS OF GROUP 13 ELEMENTS: A COMPUTATIONAL STUDY

*Kulikova Y.I.<sup>1</sup>, Timoshkin A.Y.<sup>1</sup>*

<sup>1</sup>St. Petersburg State University, St. Petersburg, Russia

Master Student

[st117590@student.spbu.ru](mailto:st117590@student.spbu.ru)

Interactions of molecular iodine with a Lewis acid (LA) allows the generation of an Iodinium ion (I<sup>+</sup>) species. Iodonium ions [IR<sub>2</sub>]<sup>+</sup> are effective metal-free catalysts in many chemical reactions, especially in organic synthesis [1]. This makes molecular iodine the focus of attention for studying its properties. Amphoteric nature of the molecular iodine in terms of Lewis acid – Lewis's base (LB) interactions was highlighted by Roald Hoffman, who compared I<sub>2</sub> with two-faced Janus [2].

Quantum chemical computations at M06-2X/def2-TZVP level of theory were employed to compute structural and thermodynamic properties of gaseous donor-acceptor complexes between I<sub>2</sub> and Lewis acids B(C<sub>6</sub>F<sub>5</sub>)<sub>3</sub> and Al(C<sub>6</sub>F<sub>5</sub>)<sub>3</sub>. Theoretical investigation of thermodynamic stability and bonding features of possible isomers of the molecular and ionic complexes of I<sub>2</sub> with LA reveals that complexes in the singlet electronic state are more stable. Reaction of I<sub>2</sub> with an Al(C<sub>6</sub>F<sub>5</sub>)<sub>3</sub> without LB instead of the molecular complex (1) results in the reaction (2). The introduction of a LB makes it possible to stabilize the resulting I<sup>+</sup> complexes (process (4)).

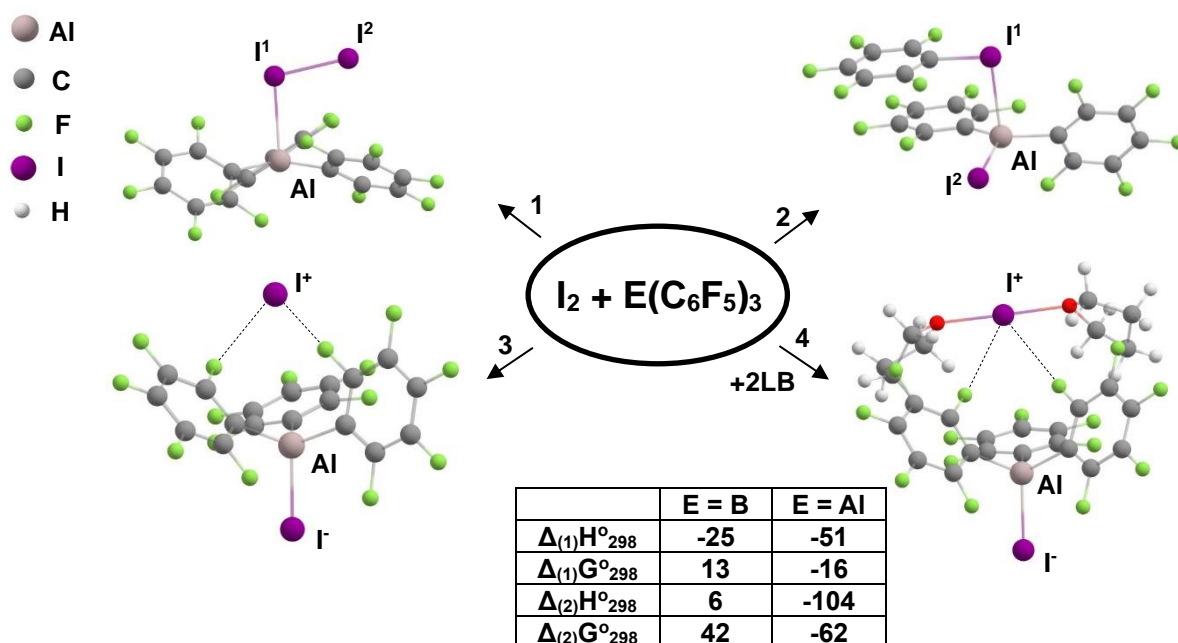

**Scheme 1.** Optimized geometries of the selected reaction products. Standard enthalpies  $\Delta_{(r)}H^{\circ}_{298}$  and standard Gibbs energies  $\Delta_{(r)}G^{\circ}_{298}$  (both in kJ·mol<sup>-1</sup>) for the selected processes.

The reaction of molecular iodine with Al(C<sub>6</sub>F<sub>5</sub>)<sub>3</sub> with formation at Al(C<sub>6</sub>F<sub>5</sub>)<sub>2</sub>I and C<sub>6</sub>F<sub>5</sub>I is exothermic, while analogous reaction with B(C<sub>6</sub>F<sub>5</sub>)<sub>3</sub> is endothermic. It is recommended for experimentalists to use boron-containing derivatives as Lewis's acids for constructing catalytic systems, since they are resistant to the side reactions (2).

## References

- [1] *Chem. Eur. J.* **2018**, *24*, 9187–9199  
 [2] *J. Am. Chem. Soc.* **2013**, *135*, 3262–3275

## Acknowledgements

Research was carried out using computational resources provided by Resource Center "Computer Center of SPbU" (project No 2402-061).

This work was supported by the Russian Science Foundation (project No 23-13-00314).

# SILICON DOPED NITROGEN ANCHORED CARBON NANOTUBES FOR OXYGEN ELECTROREDUCTION REACTION. THEORETICAL STUDY

*Kuzmin A.V., Shainyan B.A.*

A.E. Favorsky Irkutsk Institute of Chemistry SB RAS, Irkutsk, Russia

Senior researcher

[kuzmin@lin.irk.ru](mailto:kuzmin@lin.irk.ru)

Carbon-based nanomaterials doped with heteroatoms (N, S, B, F, etc.) are promising catalysts for various electrocatalytic processes due to their unique physical and chemical properties. Recently, there has been an increased interest in silicon as a dopant for N-doped carbon-based electrocatalysts for oxygen reduction reaction (ORR) [1,2], since it is the second most abundant element in the Earth's crust. Pyrolysis of multiwalled carbon nanotubes (CNTs) in the presence of silicon dichlorophthalocyanine resulted in a composite with high ORR activity,  $E_{\text{onset}}$  and  $E_{1/2}$  being 0.98 and 0.86 V vs. SHE [2], respectively. The mechanism and thermodynamics of ORR on active centers (Si and  $C^x=C^{x+1}$ , where  $x = 1, 3, 4$  and  $5$ ) were studied theoretically on model tri- and tetracoordinated silicon-doped nitrogen anchored (6,6)-armchair single-walled CNTs using UrevPBE0(C-PCM,Water)/Def2-TZVP//UrevPBE(C-PCM,Water)/Def2-SVP approach, Fig. 1a.

The chemisorption of  $O_2$  on the active Si center of model catalysts is highly exoergic (Fig. 1b, c) resulting in the formation of  $O_2^*$  Griffith-type adsorbate ( $^*OO^*$ ) and increases with decreasing the coordination number of Si. Depending on the value of potential  $U$ , the rapid reduction of  $O_2^*$  affords stable oxo  $O^*$  and hydroxy  $HO^*$  adsorbates on Si- $N_4$ /CNT, as well as oxohydroxy  $O^*HO^*$  and dihydroxy  $2HO^*$  adsorbates on Si- $N_3$ /CNT and Si- $N_{3+3}$ /CNT model structures via the dissociative ORR pathway (Fig. 1d, black arrows). Further electroreduction is impossible because it proceeds with a significant increase of  $\Delta G$ , so that the silicon center is irreversibly poisoned.

Further investigation revealed the  $C^1=C^2$  vinyl fragment of stable Si(O)- $N_4$ /CNT as the most active site for ORR (Fig. 1e). The formation of  $^*OO^*$  intermediate on the  $C_2$  site is the rate-limiting step. The predicted overpotential  $\eta_{\text{ORR}}$  value is equal to 0.31 V ( $O^*HO^* + [H^+ + e^-] \rightarrow 2HO^*$ ) in agreement with the experiment (0.25–0.37 B) [2].

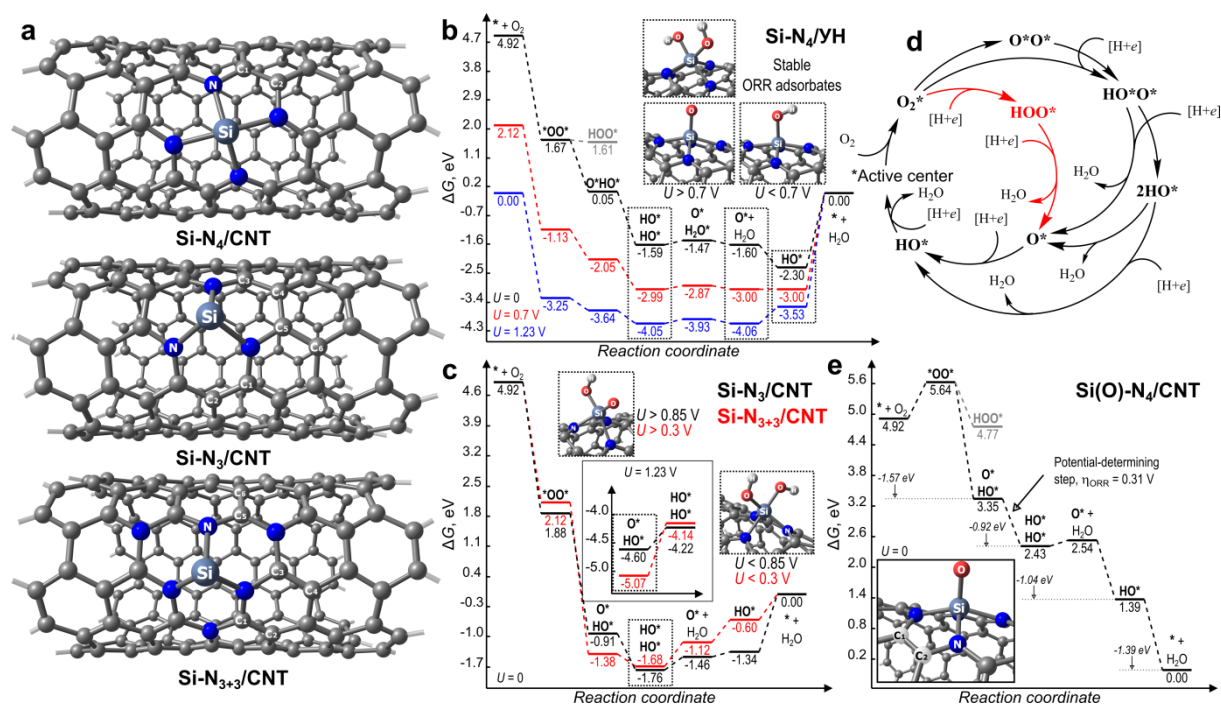

**Figure 1.** Model structures of silicon doped nitrogen anchored carbon nanotubes, Si- $N_x$ /CNT (a), free energy profiles for ORR on Si (b,c) and  $C_2$  (e) active centers, ORR catalytic cycle (d)

## References

- [1] *Int. J. Hydrog. Energy* **2022**, *47*, 30187
- [2] *J. Electroanal. Chem.* **2023**, *950*, 117859

# THEORETICAL STUDY OF NEW MAGNETIC JUNCTIONS FOR SPINTRONICS APPLICATIONS

*Larionov K.V.<sup>1</sup>, Mochalova E.A.<sup>1</sup>, Pais Pereda J.J.<sup>1</sup>, Sorokin P.B.<sup>1</sup>*

<sup>1</sup> National University of Science and Technology MISIS, Moscow, Russia

Researcher, PhD

[konstantin.larionov@phystech.edu](mailto:konstantin.larionov@phystech.edu)

In this work, the properties of magnetic heterostructures based on various nonmagnetic 2D films and half-metallic Heusler alloy  $\text{Co}_2\text{FeGe}_{1/2}\text{Ga}_{1/2}$  (CFGG) have been theoretically studied. Two terminations of the CFGG film surface are considered: by cobalt atoms or iron/germanium/gallium atoms. The preservation of ferromagnetism in the half-metal film was shown, and the effect of the magnetic moment enhancement near the surface was revealed. Analysis of the density of electronic states demonstrated a rapid recovery of CFGG half-metallicity near the interface. Moreover, in the case of Co-terminated heterostructures, 100% value of spin polarization at the first atomic layer of CFGG can be obtained. Among studied magnetic junctions, several 2D spacers including  $\text{WX}_2$  ( $X = \text{S}, \text{Se}, \text{Te}$ ) are found to be promising for spintronics applications.

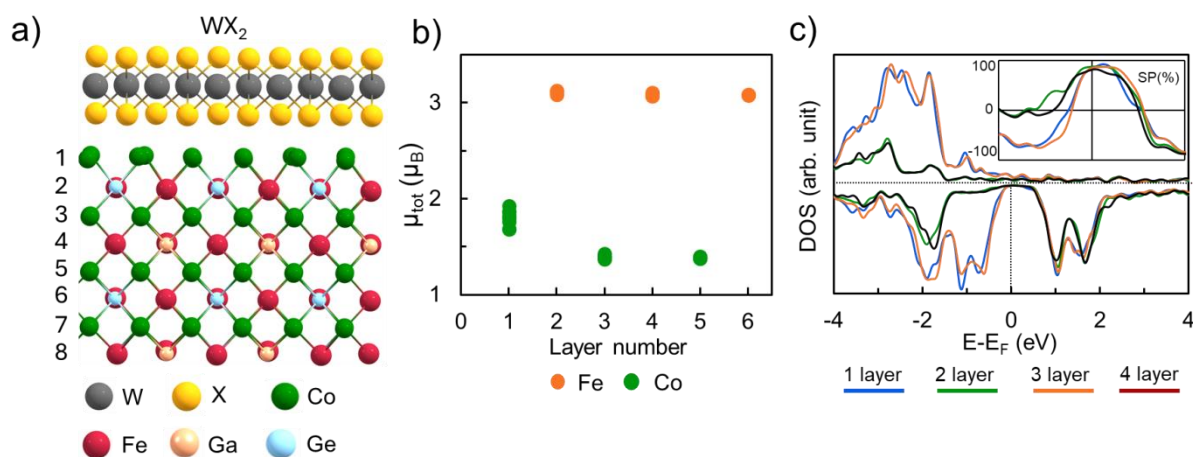

**Scheme 1.** a) Atomic structure of  $\text{WX}_2/\text{CFGG}$  heterostructure with Co-termination. b) Layer-resolved magnetic moments for Fe and Co atoms in CFGG; (c) Layer-resolved DOS of CFGG. The inset shows corresponding spin polarization level.

## References

- [1] *Advanced Materials* **2019**, *32*, 1905734
- [2] *Physical Chemistry Chemical Physics* **2022**, *24*, 1023
- [3] *ACS Applied Materials & Interfaces* **2022**, *14*, 55167

## Acknowledgements

This work was supported by the Russian Science Foundation (project No 23-79-01298).



# MOLECULAR MODELING OF THE PHOSPHORYLATION REACTION IN THE ACTIVE SITE OF PROTEIN KINASE A

*Leonova M.S.<sup>1</sup>, Krivitskaya A.V.<sup>2</sup>, Mulashkina T.I.<sup>1,2</sup>*

<sup>1</sup> Moscow State University, Moscow, Russia

<sup>2</sup> Emanuel Institute of Biochemical Physics, Russian Academy of Sciences, Moscow, Russia  
Student

[mikaellaleonova@gmail.com](mailto:mikaellaleonova@gmail.com)

Protein phosphorylation plays a huge role in cell signaling and its regulation. Protein kinases are enzymes that catalyze the phosphorylation reaction of serine, threonine, or tyrosine residues. Among human kinases, the cAMP-dependent protein kinase (PKA) was the first to be characterized, and since then it has also been subjected to the most thorough analysis, becoming the backbone of the entire family of kinases [1]. Knowing the mechanism of cell signaling between cAMP-PKA-K<sup>+</sup> [2], it is possible to identify the causes of cognitive dysfunction and neurodegenerative diseases in order to discover potential therapeutic targets.

Phosphorylation reactions are followed by the cleavage of the P-O bond. Depending on the extent of bond formation between phosphorus and nucleophilic oxygen and the cleavage of the P-O bond, dissociative and associative mechanisms may be recognized. In the dissociative mechanism, nucleophilic attack occurs before the P-O bond is broken, while in the associative mechanism, the P-O bond is split before the formation of a new bond between phosphorus and nucleophile.

Hence, the aim of this study was to determine the type of mechanism in the reaction of serine phosphorylation of the substrate SP20 in the active site of PKA. The geometric and electron-density criteria of structures corresponding to possible conformations of the enzyme-substrate complex were analyzed. In addition, the Gibbs energy profile of the serine phosphorylation reaction in the active center of PKA was predicted using molecular modeling methods.

In the present study, molecular dynamic trajectories were clustered, and three possible conformations of the enzyme-substrate complex were found, distinguished by the mutual arrangement of the substrate's serine and the phosphate tail of ATP. Representative structures were selected from these clusters, and molecular dynamics calculations were performed with the potentials of the combined quantum mechanics/molecular mechanics (QM/MM) method: for analyzing the state of the enzyme-substrate complex — without adding a bias potential, and for plotting the Gibbs energy profile — with the addition of a bias potential using the umbrella sampling method. The quantum subsystem included side chains of residues Lys72, Asp166, Lys168, serine of substrate SP20 and 7 molecules of water, as well as two magnesium cations and their coordination spheres represented by side chains of residues Asn171 and Asp184, phosphate groups of ATP and 3 molecules of water. To describe the quantum-mechanical subsystem the density functional theory method was used: PBE0 functional with Grimme's dispersion correction D3 and 6-31G\*\* basis; to describe magnesium cations we used LANL2DZ pseudopotential. The CHARMM force field was used to describe the MM subsystem. The difference between the distances of the breaking bond (P-O<sub>ATP</sub>) and nucleophilic attack (P-O<sub>Ser</sub>) was chosen as the reaction coordinate:  $\Delta = d(\text{P-O}_{\text{ATP}}) - d(\text{P-O}_{\text{Ser}})$ .

The mean value of the breaking bond length and the value of Laplacian of electron density along the line of the breaking P-O bond can be used as criteria for determining the type of mechanism. Application of these criteria to the cleaved P-O<sub>ATP</sub> bond of ATP in the active site of PKA showed that, regardless of the conformation of the enzyme-substrate complex, the phosphorylation reaction in the active site of PKA occurs by a dissociative mechanism. Analysis of the Gibbs energy profiles computed for the phosphorylation reaction of serine in the active site of PKA also showed that the reaction proceeds by a dissociative mechanism. In addition, the Gibbs energy profile for the conformational transition of the detected conformations was obtained, and it was determined which of the conformations is the most reactive.

## Acknowledgements

This work was supported by the Russian Science Foundation (project No. 23-13-00011). The research is carried out using the equipment of the shared research facilities of HPC computing resources at Lomonosov Moscow State University.

# INTERACTION OF ED-20 EPOXY RESIN WITH THE SURFACE OF MODIFIED GRAPHENE: MOLECULAR DYNAMICS STUDY

*Makarov G.I., Korenkov V.A., Makarova T.M.*

South Ural State University, Chelyabinsk, Russia

Senior researcher, PhD

[makarovgi@susu.ru](mailto:makarovgi@susu.ru)

One way to increase the affinity of epoxy matrices to carbon fibers consists in creating oxidative defects on the surface of the latter by treating it with oxidizing agents. However, experimental study of the structural organization of the epoxy binder and the interface between it and carbon fiber is complicated by the lack of long-range order in such systems. However, molecular dynamics modeling methods make it possible to study the structure and resulting properties of such composite materials [1]. We investigated the interaction between one common matrix, triethylenetetramine-cured epoxy resin ED-20, and graphene sheets containing oxidative defects (Figure 1A). We simulated four systems using molecular dynamics methods: with normal graphene (GP) and with graphene bearing hydroxyl (GP/OH), carbonyl (GP/2O) and carboxyl (GP/COOH) groups. The epoxy resin was cured in their presence in the same way as in [1] so that the epoxy resin formed one large aggregate.

The epoxy matrix densifies near the surfaces of the graphene sheets, forming a mesophase enriched in bisphenol A and epichlorohydrin residues (Fig. 1B), due to the fact that they are able to form  $\pi$ -stacking interactions with graphene. It is worth noting that the presence of an oxidative defect increased the density of the hydrogen bond network inside the epoxy matrix. The dependences of the free energy of the systems on the gap between the graphene sheet and the surface of the ED-20 resin were calculated by the metadynamics method (Fig. 1C). Introduction of an oxidative defect of any kind more than doubles the free energy of graphene sheet detachment—that is, the affinity for the epoxy matrix, with hydroxylation being the largest (Figure 1D). We believe, that the nature of this phenomenon is that the introduction of even a point defect on the surface of a graphene sheet leads to the propagation of the electron density disturbance over a significant area, increasing its ability to undergo polar interactions with the matrix.

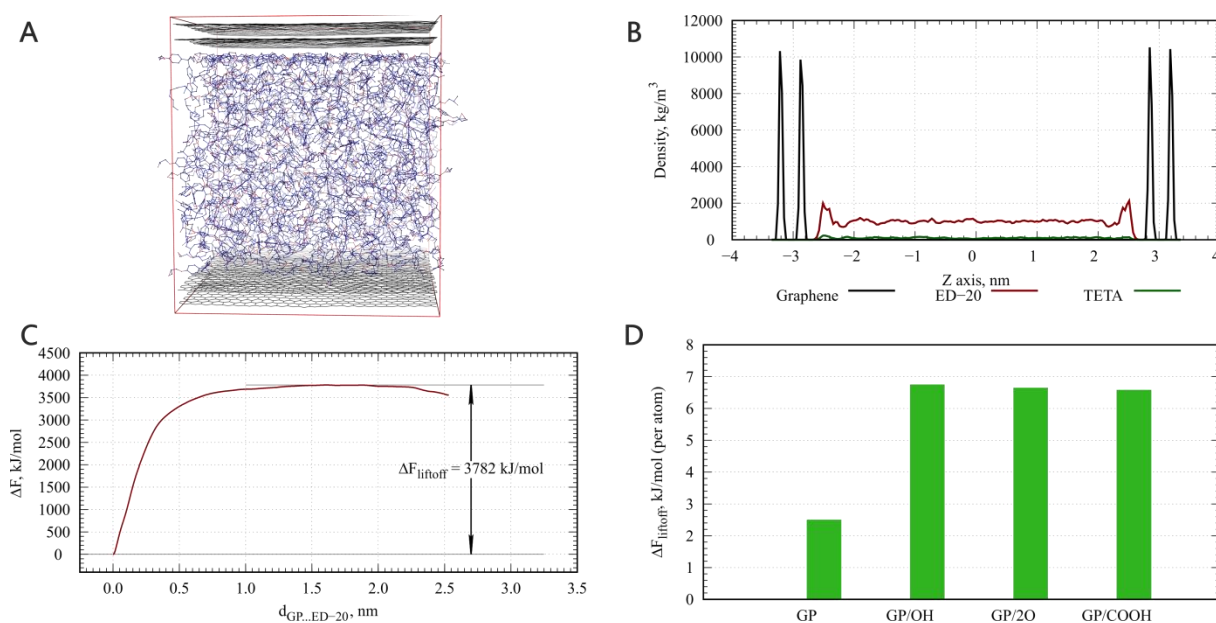

**Scheme 1.** A: Modeled cell of ED20 resin with graphene sheets. B: Density distributions of the system components along the Z axis. C: Dependence of the free energy on the distance between the ED-20 resin surface and the graphene sheet. D: Free energies of a graphene sheet liftoff from ED-20 resin depending on the defect type. Values are given per atom of the graphene sheet.

## References

[1] *J. Phys. Chem. A* **2023**, 127, 3894.

## Acknowledgements

This research was funded by the Ministry of Science and Higher Education of the Russian Federation (grant FENU 2024-0003).

# QUANTUM CHEMICAL STUDY OF THE INFLUENCE OF TORSIONAL DEFORMATIONS ON THE PROPERTIES OF CHIRAL WXY JANUS-NANOTUBES (X, Y = SE, S)

Mikhailov I. E.<sup>1</sup>, Domnin A. V.<sup>1</sup>, Evarestov R. A.<sup>1</sup>

<sup>1</sup> St. Petersburg State University, St. Petersburg, Russia  
Student  
[st087328@student.spbu.ru](mailto:st087328@student.spbu.ru)

Nanotubes based on tungsten dichalcogenides have the promising ability to serve as photocatalysts in water-splitting process [1]. It was shown that mechanical deformation has a strong effect on the nanotube's structure and electronic properties [2]. Although there are experimental works on the synthesis of WS<sub>2</sub> and WSe<sub>2</sub> nanotubes, Janus-nanotubes WSSe have not been synthesized yet. However, according to recent advances in nanomaterials technology, it might occur in the nearest future. It is relevant to understand how does torsional deformation influence stability and properties of Janus-nanotubes.

In this work we conducted first-principles calculations of several chiral (8, 2), (12, 3) Janus-nanotubes (Se inside the cylinder and outside) under torsional deformations. These deformations can be modeled with the assistance of line symmetry groups theory. In previous works [3] it was shown that quasi-1D-systems possess energy minimum that differs from the energy of non-deformed structure. **Fig. 1** represents relative energy for (8, 2) nanotubes of different composition with respect to torsion angle. Energy minimum corresponds to twisted Janus-nanotube (Se outside) with symmetry *L74<sub>46</sub>*.

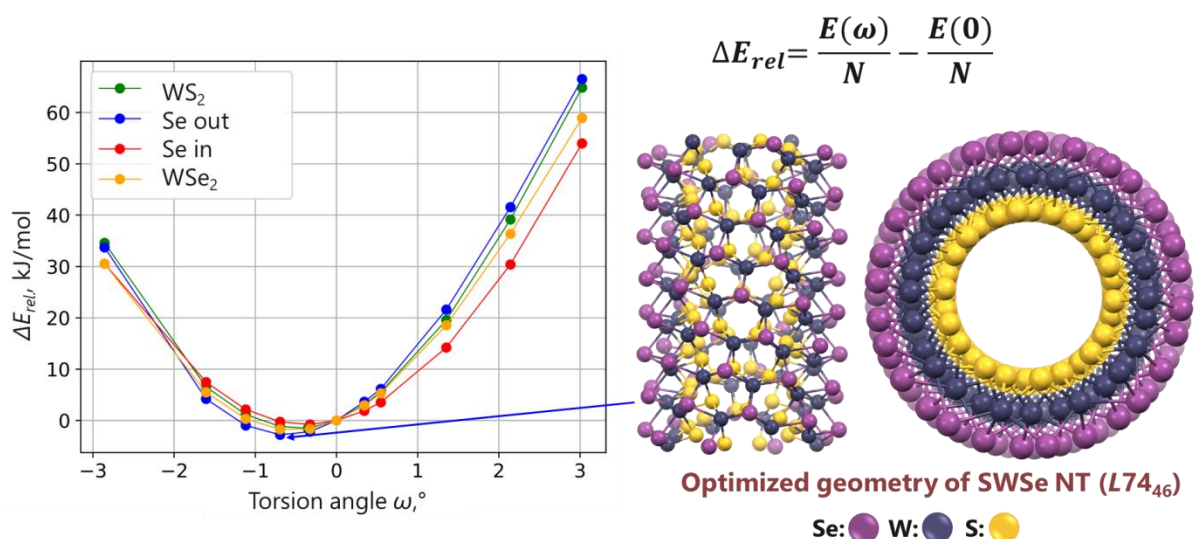

**Figure 1.** Relative energy of WXY (X, Y = Se, S) nanotubes dependence on torsion angle

The effect of torsional deformation on the diameter changes and band gap value was also studied for Janus-NTs. Electron band structures of distorted nanotubes were calculated in this study. We showed that the nature of transition can be changed from indirect to direct as the deformation is applied, because the positions of valence band top and conduction band bottom change. This fact suggests that nanotube's electronic structure can be tuned by applying certain mechanical twisting.

## References

- [1] Piskunov S. et. al., *ACS omega* **2019**, *4*, 1, 1434-1442
- [2] Domnin A. et. al., *Nanomaterials* **2023**, *13*, 19, 2699
- [3] Porsev V. et. al., *Computational Materials Science* **2022**, *203*, 111063

## Acknowledgements

The authors highly appreciate the assistance of Saint-Petersburg state University's "Computer Center" for high-performance computing.

## THERMODYNAMIC VIEW ON THE ESTERIFICATION REACTION KINETICS

*Misikov G.Kh.<sup>1</sup>, Samarov A.A.<sup>1</sup>, Toikka A.M.<sup>1</sup>, Trofimova M.A.<sup>1</sup>*

<sup>1</sup> St. Petersburg State University, St. Petersburg, Russia  
[st062450@student.spbu.ru](mailto:st062450@student.spbu.ru)

The esterification reaction, which is a widely used for synthesis of various esters both in laboratory and for industrial purposes, has been widely studied in terms of chemical kinetics. A lot of information on its rate, yield and mechanism under different conditions is presented in literature. At the same time, most of the kinetic research consider only concentration parameters depending on time, without discussing thermodynamic properties such as activities and, consequently, chemical potentials. Works on comprehensive analysis of thermodynamic and kinetic properties for multicomponent reactive systems remains rather limited. That is why the relation between thermodynamic properties of a reactive system and the rate of a proceeding reaction remains not clear enough, with only a thermodynamic equilibrium constant seeming to be the only link between chemical thermodynamics and chemical kinetics.

In this work we present our result on investigating the kinetics of the ethyl acetate synthesis reaction in terms of both concentration (liquid and vapour phase compositions) and thermodynamic (chemical potentials and chemical affinity) properties. In our previous paper [1] we reported experimental thermodynamic and kinetic data for the n-butyl acetate synthesis esterification reaction together with the theoretical analysis of the relation between chemical affinity and reaction rate. Now we focus our attention not only on obtaining experimental data for the ethyl acetate, but also on the implementation of the thermodynamic approach (classical and non-equilibrium) to obtain more general relations describing connection between reaction rate and chemical affinity.

Kinetics of the ethyl acetate synthesis reaction was studied at 313.15 K. The dynamic flow still was used to investigate vapour-liquid equilibria (VLE). Compositions of both liquid and vapour phases were measured by gas chromatography. Activity coefficients were calculated based on the experimental VLE data, when the components in the vapour phase, except acetic acid, were considered as ideal gases. For acetic acid vapour the associated ideal gas approach was applied. The activity coefficients were used to estimate chemical affinity values along the stoichiometric line. The obtained dependence of the esterification reaction rate was compared with one for the n-butyl acetate synthesis reaction.

Chemical affinity may be correlated to the reaction rate [2]. However, it is believed by some researchers that chemical affinity cannot be considered as the driving force of a reaction. Our results showed that the relation between the rate and chemical affinity could be expressed in a linear form (as given in the well-known linear approximation of non-equilibrium thermodynamics) with the kinetic coefficient being the function of the system composition along the stoichiometric line.

### References

[1] *Russ. J. Phys. Chem. A.* **2024**, *8*, 1478

[2] *Phys. Chem.* **2014**, *228*, 793

### Acknowledgements

This work was supported by the Russian Science Foundation (project No 23-23-00227).

# ACCURATE *AB INITIO* ENTHALPIES OF FORMATION OF GROUPS 10–12 METAL COMPLEXES WITH TETRAPHENYLPORPHYRIN

*Moshchenkov A.D.*<sup>1</sup>, *Otlyotov A.A.*<sup>1</sup>, *Minenkov Y.V.*<sup>1</sup>

<sup>1</sup>Semenov Research Center of Chemical Physics, Moscow, Russia

PhD student

[andrey.moschenkov@chph.ras.ru](mailto:andrey.moschenkov@chph.ras.ru)

Metal complexes of tetraphenylporphyrin (MTPPs) are widely used in catalysis and in the development of the gas sensing materials. Reliable theoretical modeling of physico–chemical processes involving these compounds is based on their fundamental thermochemical properties, such as enthalpy and Gibbs energy of formation, entropy, and heat capacity. However, experimental gas and solid–state enthalpies of formation have been only reported for ZnTPP.[1] In this work, we critically evaluate the gas-phase  $\Delta_f H_m^0(\text{ZnTPP})$  and for the first time predict enthalpies of formation for other MTPPs with M = Ni, Cu, Pd, Ag, Cd. Our theoretical verification is based on the high–level calculations using local coupled cluster method, DLPNO–CCSD(T) in conjunction with complete basis set (CBS) extrapolation. Enthalpies of formation of the target MTPPs are predicted via the reaction–based approach[2,3] and several thousand balanced model chemical reactions, automatically generated using a special program previously developed in our group. [4] Only compounds with the enthalpies of formation accurately known from experiment and/or confirmed by independent calculations were selected as reactants. Particularly, small reference species containing Groups 10–12 metals were recommended in our recent work.[5]

The gas–phase enthalpy of formation of ZnTPP obtained using the above-described procedure is  $227.0 \pm 3.4 \text{ kcal mol}^{-1}$ , which does not support the experimental value of  $132.0 \pm 2.0 \text{ kcal mol}^{-1}$ . [1] Additional evaluations based on the model reactions  $\text{ZnTPP} + 2\text{HX} = \text{H}_2\text{TPP} + \text{ZnX}_2$  (X = F, Cl),  $\text{ZnTPP} + \text{H}_2\text{Y} = \text{H}_2\text{TPP} + \text{ZnY}$  (Y = O, S) and various DFT functionals (PBE0-D4, B3LYP-D4,  $\omega$ B97M-V) paired with cc-pVQZ basis sets yielded the  $\Delta_f H_m^0$  values in the range of  $220.2 - 231.8 \text{ kcal mol}^{-1}$ .

Gas–phase enthalpies of formation were derived for other MTPPs and combined with experimental enthalpies of sublimation[6] to yield the corresponding solid–state values. Besides, the results of the calculations were used to evaluate relative stabilities of the studied metalloporphyrins previously described by Feixas et al.[7] on the basis of the energy decomposition analysis.

## References

- [1] *J. Chem. Thermodyn.* **2002**, 34, 193
- [2] *Inorg. Chem.* **2020**, 59, 17084–17095
- [3] *Struct. Chemistry* **2021**, 32, 553
- [4] *Phys. Chem. Chem. Phys.* **2022**, 24, 3163
- [5] *J. Chem. Thermodyn.* **2023**, 187, 107151
- [6] *J. Porphyr. Phthalocyanines.* **2000**, 4, 699
- [6] *Can. J. Chem.* **2009**, 87, 1063

## Acknowledgements

This work was supported by the Russian Science Foundation (project No 24-23-00302).

# PREDICTIVE THEORETICAL APPROACH TO THE DEVELOPMENT OF THE OPTICAL SENSORS FOR INDIVIDUAL IONIC ACTIVITIES

Nosov V.G.<sup>1</sup>, Peshkova M.A.<sup>1</sup>

<sup>1</sup> St. Petersburg State University, St. Petersburg, Russia

Student

[nosoff.vitia2018@yandex.ru](mailto:nosoff.vitia2018@yandex.ru)

Ion-selective optodes are based on the same lipophilic compounds as ion-selective electrodes (ISEs) and their response is based on electrochemical processes: ion-exchange or co-extraction between the sensing phase and the contacting solution. However, optodes can only detect either a ratio or a product of the two ion activities: of the analyte ion and the reference ion, similarly to the electrolyte activity measurement in a galvanic cell without liquid junction. The first attempt to generally solve the problem of assessing individual ion activity optically was introduced in [1,2].

It was shown that the single ion optical sensor can be considered as an analogue to the galvanic cell with a liquid junction. In order to assess individual ion activities with an optode the Galvani-potential at the interface between the polymeric optode membrane and aqueous solution must be stabilized. This can be achieved by introducing into the membrane phase a moderately lipophilic electrolyte which distributes between the phases and stabilizes the interfacial Galvani-potential by building a virtual "reference chamber" in the solution in the vicinity of the membrane. Similar approach was implemented in order to solve well-known potentiometric problem of an all-plastic reference electrode [3].

For Na/pH-selective polymeric optical sensors containing lipophilic electrolyte a wide-scale computational simulation of response patterns is carried out in Maple 2023. Dependence of inflection point on wide range of parameters such as lipophilicity of ionic additives, ion-ionophore and ion-chromoionophore stability constants, and concentration of membrane components is theoretically discovered (Fig. 1A). For the first time, a theoretical model suggested optimal parameters of the optode components *a priori* in order to stabilize the interfacial potential at the polymeric optode/aqueous solution boundary. This became possible due to new approaches to the analysis of optode response. As example, for PVC/DOS-based optode containing ionophore Na VI, chromoionophore III and lipophilic Q<sup>+</sup>B<sup>-</sup> electrolyte, interfacial potential is stabilized by Q<sup>+</sup> cation with distribution coefficient of 10<sup>6.47</sup>. The results of this model are not limited to the cationic nature of the optical response and plausible for all types of polymeric optical sensors. To confirm the theoretical results, six optode compositions were studied in detail. The pH-calibrations of all compositions were carried out with five different sodium chloride concentrations (0.1, 0.01, 0.001, 0.0001 and 0.00001 M). Experimental response curves are in complete agreement with the developed theoretical model with minor deviations due to chromoionophore leaching (Fig. 1B).

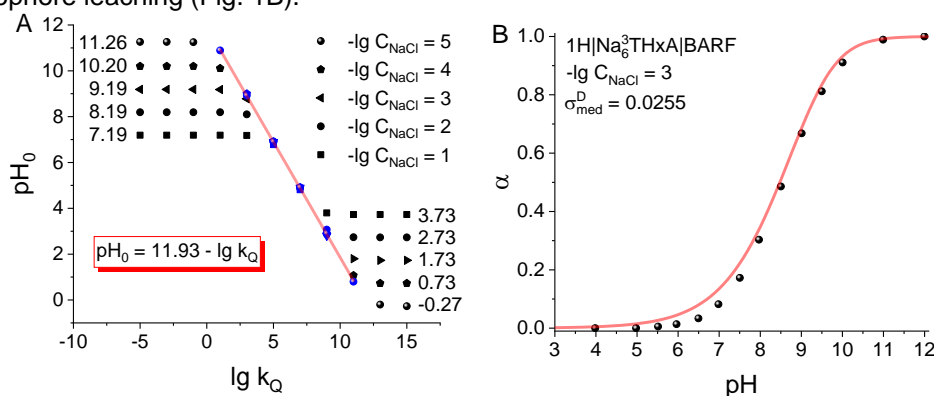

**Figure 1.** Theoretical dependance of inflection point  $pH_0$  on  $Q^+$  lipophilicity constant (A); comparison of experimental data with theoretical response pattern for PVC/DOS-based optode containing ionophore Na VI, chromoionophore III, THxA<sup>+</sup>BARF<sup>-</sup> ionic additive at  $-\lg C_{NaCl} = 3$ .

## References

- [1] *Sens. Actuat. B.* **2015**, 207, 346
- [2] *ACS Sens.* **2023**, 8, 8, 3086.
- [3] *Membranes (Basel)*. **2023**, 13, 1, 118.

## Acknowledgements

This work was supported by the Russian Science Foundation (project #20-73-10033).

# ESTIMATING ELECTRON TRANSFER RATES OF DNA REPAIR BY MEANS OF MULTICONFIGURATION QUANTUM CHEMISTRY CALCULATIONS

*Odintsov K.V., Domratcheva T.M.*

Moscow State University, Moscow, Russia

PhD. Student

[konstantin.odintsov@chemistry.msu.ru](mailto:konstantin.odintsov@chemistry.msu.ru)

When absorbing a quantum of ultraviolet radiation, DNA bases form covalent adducts that disrupt DNA functions. The most common adducts are cyclobutane dimers and pyrimidine–pyrimidone (6-4) photoproducts of pyrimidine bases. Enzymes photolyase, activated by a photon in the visible spectral region, repair such damage facilitating the rupture of covalent bonds between the bases. The quantum of light is absorbed by the enzyme's cofactor flavin adenine dinucleotide (FADH<sup>-</sup>) present in the reduced anionic form. Photoexcitation activates the transfer of an electron from a cofactor to the DNA photoproduct affording a radical-pair state susceptible to the rearrangement of covalent bonds which in turn produces two separate DNA bases. While the quantum yield of the CPD photoproduct repair reaches 40-100% the yield of the (6-4) photoproduct repair does not exceed 20% [1]. The decrease is due to the fact that in the 6-4 photolyase the speed of the bond rearrangement in the radical state is about 10 times slower than the decay of the radical state back into the initial state [2,3]. Despite many years of research, the mechanism of reducing the quantum yield in 64 photolyase remains controversial.

In this work, we investigate how the dynamic environment of the active site causes the quantum yield decrease of 64 photolyase in comparison to CPD photolyase. Our analysis is based on estimates of electron transfer rates according to Marcus theory. To this end, energies of electronic states and dipole moments were computed by means of multi-configuration quantum chemistry SA-CASSCF/XMCQDPT2 method. The non-adiabatic electronic-state couplings were estimated using the generalized Mulliken-Hush scheme [4]. The calculations were performed for cluster models of the active sites of the 64 and CPD photolyases. The influence of reorganization energies on the electron transfer rates was considered. Our results indicate that adenine of FADH plays crucial role in affording fast decay of the radical state in 64 photolyase.

## References

- [1] *Photochemistry and Photobiology*. **2017**, 93, 51
- [2] *Nature*. **2010**, 466, 887
- [3] *ACS Catal. American Chemical Society*. **2022**, 12, 3041
- [4] *Chem. Phys. Lett.* **1996**, 249, 15

## Acknowledgements

This work was supported by the Russian Science Foundation (project No 22-23-00418).

# THEORETICAL STUDY OF DIBENZOCROWN ETHERS COMPLEXATION WITH ALKALINE AND ALKALINE-EARTH METALS IN FLUORINATED SOLVENTS

*Ostras A.S.<sup>1</sup>, Timoshenko V.V.<sup>2</sup>*

<sup>1</sup>Infochemistry Scientific Center, ITMO University, 191002 St. Petersburg, Russia

<sup>2</sup>St. Petersburg State University, St. Petersburg, 199034 Russia

3<sup>rd</sup> Year PhD Student

E-mail: [st052055@student.spbu.ru](mailto:st052055@student.spbu.ru)

Over the last few decades, crown ethers have become an important class of macrocyclic compounds, which found its application in different branches of chemistry and technology, e.g. analytical chemistry, electrochemistry, organic synthesis and medicine. Due to possessing of certain size inner cavity, crown ethers can selectively bind different metal ions to form «host-guest» complexes with high stability constants. In the industry, this phenomenon is widely used in radionuclides' separation from high-level waste (HLW), mainly radiocesium <sup>137</sup>Cs and radiostrontium <sup>90</sup>Sr. That elements can easily accumulate in water and therefore provide high damage on humans' health and environment. Although a lot of various separation technologies were proposed in recent years, selective removing of <sup>137</sup>Cs and <sup>90</sup>Sr from wastewater still remains a challenge task.

In this work we provided theoretical study of dibenzocrown ethers complexation properties towards different alkali and alkaline-earth metals in unusual solvents. As complexing agents we considered 4,4'(5')-di-tert-butyl-dibenzo-18-crown-6 ethers and as organic media we considered bis-(2,2,3,3-tetrafluoropropyl)carbonate (BK-1), bis(2,2,3,3-tetrafluoropropoxy)methane (FN-1) and 1-fluorooctane (FO-1).

Our first main goal was to obtain the most possible structures of alkali and alkaline-earth complexes with crown ethers in water and organic solutions and evaluate their geometrical and electronic parameters. The second main goal was to study the thermodynamics of complexation process by determining stability constants of metal-crown complexes in different solutions.

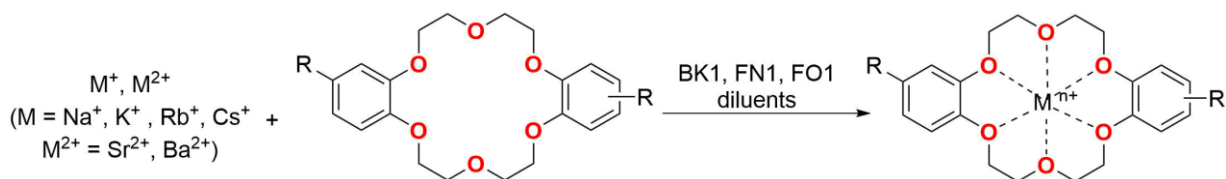

**Scheme 1.** Complexation of substituted dibenzo-18-crowns-6 with metal ions in fluorinated solvents.



# QUANTUM-CHEMICAL MODELING OF MAGNETIC RESONANCE PARAMETERS AND OPTICAL PROPERTIES OF COPPER COMPLEXES WITH SPIRONAPHTHOXAZINES

*Pomogailo D.A.<sup>1,2</sup>, Selivantiev Yu.M.<sup>1</sup>, Spitsyn N.Yu.<sup>1</sup>, Raitman O.A.<sup>1</sup>*

<sup>1</sup> D.I. Mendeleev University of Chemical Technology of Russia, Miusskaya Sq. 9, Moscow, 125047, Russia

<sup>2</sup> M.V. Lomonosov Moscow State University, Chemical Department, Leninskie Gory 1/3, Moscow, 119991, Russia,

Assistant professor, PhD in chemistry

[texafirin@ya.ru](mailto:texafirin@ya.ru)

Spiroanthoxazine/Cu<sup>2+</sup> complexes have been investigated by means of quantum chemistry, electron paramagnetic resonance (EPR), and optical spectroscopy.

Quantum chemical calculations have been mainly performed by means of the unrestricted density functional theory method using the ORCA 5.0.4 program package [1]. R<sup>2</sup>SCAN-3C functionals together with the full-electron mTZVP basis set have been used to calculate the geometry of potential energy surface (PES) minima. Geometries at minima have been additionally checked for the absence of imaginary vibration frequencies. The spin-Hamiltonian parameters have been calculated using the B3LYP functional together with the full-electron def2-TZVP basis set. CPCM was applied to take into account the influence of the solvent on electronic structure of complex. Comparison of experimental Electron Spin Resonance and optical spectra with modelled ones were made in this work.

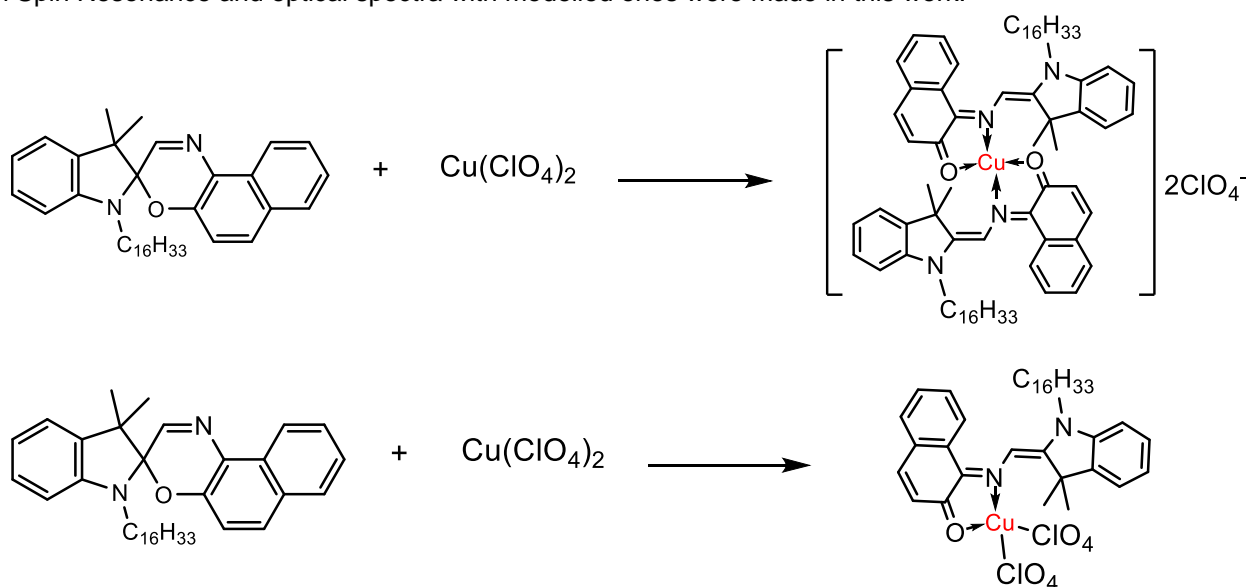

**Figure 1.** Geometry of complex of spiroanthoxazine with copper.

## References

[1] *WIREs Comput. Mol. Sci.*, **2017**, e1327

## Acknowledgements

The work was supported by the Ministry of Science and Higher Education of the Russian Federation (project FSSM-2023-0003).

# THERMOPHYSICAL PROPERTIES OF LIQUID ELECTROLYTES AND CRYSTAL STRUCTURE PREDICTION USING MOMENT TENSOR POTENTIAL

*Rybin N.<sup>1,2</sup>, Chalykh O.<sup>1</sup>, Noviko I.<sup>1</sup>, Shapeev A.<sup>1,2</sup>*

<sup>1</sup> Skolkovo Institute of Science and Technology, Bolshoi Boulevard 30, bld.1, Moscow, Russia

<sup>2</sup> Digital Materials LLC, Kashirskoe highway 3, bld.12/2, Moscow, Russia

Research Scientist

[n.rybin@skoltech.ru](mailto:n.rybin@skoltech.ru)

Highly accurate *ab initio* molecular dynamics (MD) methods are the standard for studying physical and chemical properties of liquid electrolytes. However, such methodology is frequently too expensive to capture some key properties that converge slowly with respect to simulation length and time scales, for example, thermal and electrical conductivities. Machine learning (ML) approaches, which reach the accuracy of *ab initio* simulation, and which are, at the same time, sufficiently affordable hold the key to bridging this gap. In this work we present a robust and accurate machine-learned potentials (Moment Tensor Potential [1]) for the LiF-NaF-KF (FLiNaK [2]) melt and EC:EMC (Ethylene Carbonate/Ethyl Methyl Carbonate) solvent.

FLiNaK is a system that demonstrates significant potential for applications in next-generation nuclear reactors, necessitating a comprehensive understanding of their thermophysical properties for technological advancements. Experimental measurement of the properties of FLiNaK poses challenges, due to factors such as impurity control and corrosion. We performed molecular dynamics (MD) simulations of several thermophysical properties of the FLiNaK melt, including density, self-diffusion coefficients, viscosity, and thermal conductivity. Our results on thermophysical properties calculations exhibit strong agreement with experimental data.

The EC:EMC mixture is a key component of liquid electrolytes in rechargeable Li-ion batteries. We identify the necessary ingredients needed to successfully model this liquid mixture of organic molecules. In particular, we address the challenge posed by the separation of scale between intra- and inter-molecular interactions, which is a general issue in all condensed phase molecular systems. An important aspect of our methodology is the incorporation of an active learning scheme [3], which enables the generation of a robust and accurate potential, while maintaining a moderate-sized training dataset.

In addition to liquid electrolytes, we are going to present how moment tensor potential method can be used to predict polymorphs of molecular crystals. We will show the methodological developments and benchmarks for benzene and glycine.

## References

[1] *Multiscale Modeling and Simulations*, **2016**, 14(3), 1153-1173

[2] *arXiv preprint arXiv:2402.18220*

[3] *Computational Materials Science*, **2017**, 140, 171-180

# INTERACTIONS OF IODINE WITH ACIDS OF THE $AlR^F_3$ TYPE ( $R^F$ - BULKY PERFLUORINATED SUBSTITUENTS) IN VARIOUS SOLVENTS

*Sharapova D.A., Zavgorodniy A.S.*

Saint Petersburg State University, Saint-Petersburg, Russia,  
Student

[st117524@student.spbu.ru](mailto:st117524@student.spbu.ru)

Molecular iodine forms numerous donor-acceptor complexes, but usually functions as a Lewis acid. Complexes in which iodine acts as a Lewis base are possible, but quite rare [1] so a great interest to them arises.  $Al[OC(CF_3)_3]_3$  and  $Al[OC(C_6F_5)_3]_3$  are acids of the  $AlR^F_3$  type, where  $R^F$  stands for bulky perfluorinated substituents and those are Lewis superacids [2,3]. Therefore, in complexes with those acids, iodine can exhibit donor properties. Within the scope of this work, the interactions between stated acids with iodine will be carried out observed in various solvents as well as without solvent. It is expected that formation of either 1:1 molecular complexes or ionic complexes  $[AlR^F_3][I(solv)_n]^+$  will be observed.

According to quantum chemical computations, iodine can not displace donor solvents such as diethyl ether from complexes with acids, so those will not be used. It is currently known that in a toluene solution, the acid  $Al[OC(C_6F_5)_3]_3$  does not form a complex with iodine, so other solvents will be used instead. It is also planned to use fluorobenzene and liquid  $SO_2$  as a solvents.

## References

[1] *J. Am. Chem. Soc.* **2013**, 135, 3262

[2] *Angew. Chem.* **2008**, 47, 7659.

[3] *European Journal of Inorganic Chemistry*, **2019**, 31, 3612

This work was supported by the Russian Science Foundation, project №23-13-00314

The work is carried out using equipment of the resource centers of St. Petersburg State University "Centre for Magnetic Resonance" and "Center for X-ray Diffraction Studies".

# INFLUENCE OF IRON SPIN STATE AND LIGAND NUMBER ON ELECTRONIC STRUCTURE OF MODEL HEMOPROTEINS

*Shitov D.A.<sup>1</sup>, Kaplanskiy M.V., Tupikina E.Yu.<sup>1</sup>*

<sup>1</sup> St. Petersburg State University, St. Petersburg, Russia

Master's student

[shitovsky@gmail.com](mailto:shitovsky@gmail.com)

Imidazole is a five-membered nitrogen-containing aromatic heterocycle, combining in its structure two types of nitrogen atoms: «pyridine-like» and «pyrrole-like». That's why, the imidazole molecule can participate in the formation of various non-covalent interactions: hydrogen bonds with proton donors and acceptors, NH- $\pi$  and  $\pi$ - $\pi$  interactions, bonding with metals, and so on.

Various non-covalent interactions into which the imidazole ring enters can interact with each other [1]. Of particular interest is the effect of the coordination of imidazole by the «pyridine-like» nitrogen on the metal (Figure 1, blue colour) on its proton-donor properties: the formation of hydrogen bonds through the «pyrrole-like» NH-group (Figure 1, red colour). For example, in hemoproteins, the amino acid histidine, due to coordination along the iron, varies the strength of hydrogen bonds and oxygen affinity of iron (Figure 1, green colour), which changes the biological activity: electron transfer and oxygen transport processes [2]. The most common pattern of such molecules based on X-ray diffraction data [3]: imidazole complexes with an iron as part of a porphyrin heterocycle, which was chosen as model complexes in the study (Figure 1).

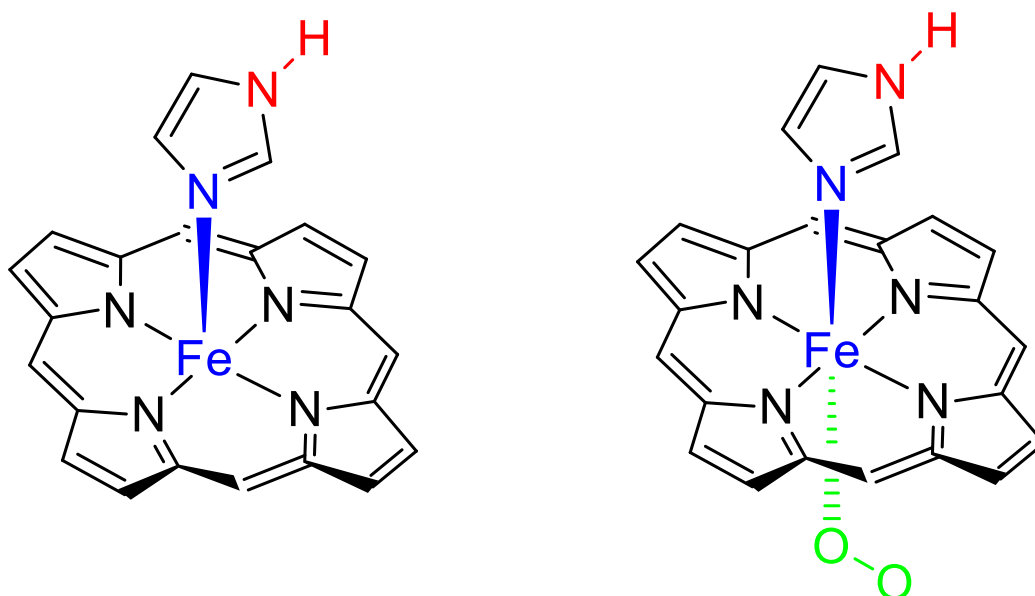

**Figure 1.** Model complexes: imidazole, coordinated to iron in the porphyrin fragment.

In this research quantum chemistry methods were used to study the dependence of the structure of complexes of imidazole on coordination to iron and also the oxygen affinity of iron in various charge (+2, +3) and spin (singlet, doublet, triplet, quartet and quintet) states. Quantum mechanical calculations were performed on PW6B95-D3/jorge-TZP-DKH level of theory including scalar (spin-free) relativistic terms in electronic Hamiltonian.

## References

- [1] *Journal of Computational Chemistry*. **2024**, 13, 1046
- [2] *Molecules* **2018**, 10, 2561
- [3] *Biochemistry* **2002**, 41, 7293

## Acknowledgements

This work was supported by the Russian Science Foundation (project No 22-73-00094).

# SIMULATION OF ZEOLITE MEMBRANE GAS SEPARATION BY NONEQUILIBRIUM MOLECULAR DYNAMICS

*Shulepov R.R., Sizov V.V., Sizova A.A.*

St. Petersburg State University, St. Petersburg, Russia

Student

[st106289@student.spbu.ru](mailto:st106289@student.spbu.ru)

An important part of technological processes in modern industry is the management of carbon dioxide emissions via post-combustion treatment of flue gas. Non-reactive techniques based on gas adsorption and diffusion in porous media are a promising class of methods for the separation of gas mixtures.

Molecular dynamics simulations with dual control volume were used to investigate the adsorption and permeation of  $N_2/CO_2$  gas mixtures of various composition in zeolite membrane. All-silica zeolite A was used for model membranes. To implement a non-equilibrium MD simulation protocol, the simulation cell was divided into several zones (**Fig.1**). The gas mixture with a given composition and pressure is located in the control volume 1. During the classical NVT-MD simulation, the molecules penetrate the membrane and reach the control volume 2, where a desired pressure value is maintained, while the composition of the gas stream leaving the membrane is allowed to vary.—Composition/pressure limitations in both control volumes are applied periodically with a time step of 50 ps: the required number of molecules is added or subtracted to maintain the composition and pressure (density) in the control volume 1 and the required number of gas molecules is removed from the control volume 2 to provide the required value of pressure.

In the present work, the effects of the pressure gradient (determined as the pressure difference between the control volumes) and the composition of the input gas stream (control volume 1) were examined. Calculations were carried out at 298 K and 318 K. The total simulation times required to reach the stationary state of the systems were up to 2  $\mu$ s. The results obtained under different conditions were compared.

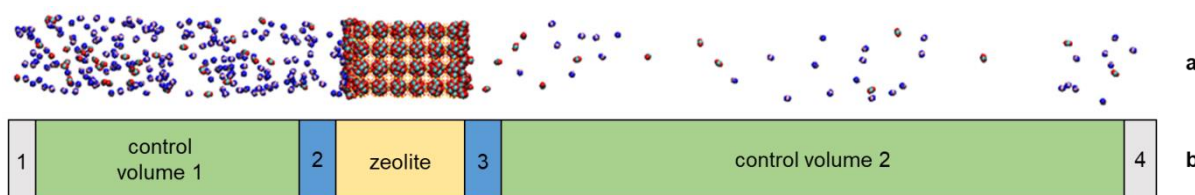

**Figure 1.** A snapshot (a) and the general setup (b) of the simulation cell: 1 – barrier wall and technical volume 1; control volume 1; 2 –buffer zone 1; zeolite; 3 –buffer zone 2; control volume 2; 4 – barrier wall and technical volume 2.

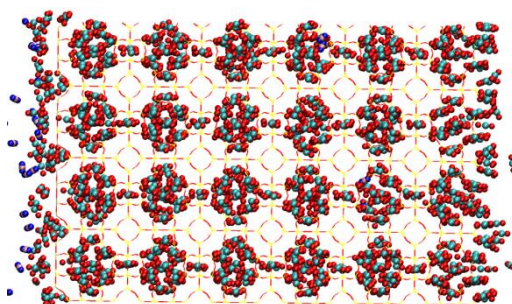

**Figure 2.** Zeolite filled with  $N_2/CO_2$  gas mixture (14%  $CO_2$  in input stream) at 298 K.

The analysis of computational data provides information on the selectivity and permeability of the membrane along with the capacity and selectivity of the porous zeolite material. A typical snapshot of the zeolite filled with gas can be found in **Fig.2**. Based on the results obtained, the optimal conditions for the separation of gas mixtures by zeolite membrane can be proposed.

## MODELLING THE SOLUBILITY OF COMPOUNDS IN WATER USING OPEN DATA

*Sibgatullina T.I.<sup>1</sup>, Afonina V.A.<sup>1</sup>, Gimadiev T.R.<sup>1</sup>*

<sup>1</sup> Kazan Federal University, Kazan, Russia

Junior researcher

[TSibgatullina@kpfu.ru](mailto:TSibgatullina@kpfu.ru)

The solubility of compounds in water plays a key role in various fields, including but not limited to drug development, agrochemicals, fertilisers, development of paints, coatings and battery materials. This property is a strategically important parameter in synthetic and medicinal chemistry as it affects bioavailability. A better understanding of this property will improve success in drug development. However, measurement of water solubility is not always possible in the early stage of discovery of new compounds. For this reason, *in silico* predictive approaches have become very valuable for prioritising potential drugs and reducing the number of experimental trials, and predicting water solubility remains a challenging and relevant chemistry problem [1].

The objective of our study was to gather extensive experimental water solubility data from all available public sources, including scientific articles and chemical databases, and to develop the most effective model based on the collected data. Solubility data were obtained for 145,185 compounds. Among these, thermodynamic solubility data were available for 63,128 compounds, while kinetic solubility data were available for 82,057 compounds. After cleaning and standardizing data, 40,913 compounds remained in the thermodynamic dataset, and 75,900 in the kinetic dataset. A comparison of these datasets revealed that both kinetic and thermodynamic solubility data were available for 1,994 compounds. These compounds were compiled into a separate dataset.

An artificial neural network (ANN) was chosen to model the solubility of organic compounds in water due to the large volume of data, enabling the use of deep learning methods. Quality metrics such as the coefficient of determination ( $R^2$ ), RMSE, and MSE were used to evaluate the results. Developed ANN had two outputs and two hidden layers. Fragmented hashed atom-centered descriptors of 1024 bits in length were used for training. Both thermodynamic and kinetic solubility for all compounds were predicted simultaneously. The training results for the best model were as follows: overall  $R^2 = 0.71$  and overall RMSE = 0.68. These results indicate a good quality model, although further improvement and optimization of the existing ANN are planned.

### References

[1] Llompart P., Minoletti C., Baybekov S., Horvath D., Marcou G., Varnek A. *Scientific Data*, **2024**, 11, 303

### Acknowledgements

This work was funded by the subsidy allocated to Kazan Federal University for the state assignment in the sphere of scientific activities FZSM-2024-0002.

# COMPUTATIONAL REDOX POTENTIAL PREDICTIONS: APPLICATION TO ORGANIC MOLECULES USED IN NUCLEAR REPROCESSING

*Smirnov M.V.<sup>1</sup>, Karpov K.V.<sup>1</sup>, Mitrofanov A.A.<sup>1</sup>*

<sup>1</sup> Moscow State University, Moscow, Russia

Student, specialist, 6<sup>th</sup> year

[mvad.smirnov@gmail.com](mailto:mvad.smirnov@gmail.com)

Today, nuclear reprocessing (chemical separation of fission products and actinides from spent nuclear fuel) is an important direction of nuclear power development. Currently, Russia has adopted the concept of closing the nuclear fuel cycle (NFC), according to which spent fuel is processed with extraction of uranium and plutonium in the PUREX process and further solidification of liquid high-level radioactive waste (HLW) [1]. However, according to Rosatom State Corporation, at the end of 2022 about 330 thousand tons of spent fuel have been accumulated in the world, including about 26.2 thousand tons in Russia, while the percentage of spent fuel reprocessing from the volume of annual production in our country is only 25% [2]. More complete use of the energy potential of nuclear fuel will not only solve the problem of HLW storing, but will also accelerate implementation of a closed NFC.

Various chemical elements are present in spent nuclear fuel in a wide range of oxidation states. During spent fuel reprocessing, it becomes necessary to separate these elements. One can use selective oxidation or reduction of cations mediated by small (with a weight of  $\leq 1000$  daltons) redox-active organic molecules.

Recently, deep learning models, including Graph Neural Networks (GNNs), have been widely used to solve Quantitative Structure-Property Relationship (QSPR) problems, such as predicting redox potentials and solubility. These models represent molecules as 2D graphs with atoms as nodes and bonds as edges [3]. Such networks automatically learn chemical patterns by aggregating feature representations of neighboring atoms (Figure 1). The required input information is only the molecular graphs, which can be easily obtained by converting the widely used SMILES (Simplified Molecular Input Line Entry System) strings.

The aim of this work is to develop an algorithm that, when given information about a molecule and a solvent, predicts the redox potential in that solvent as accurately as possible. A Graph Convolutional Neural Network (GCNN) was trained for this purpose (Figure 1).

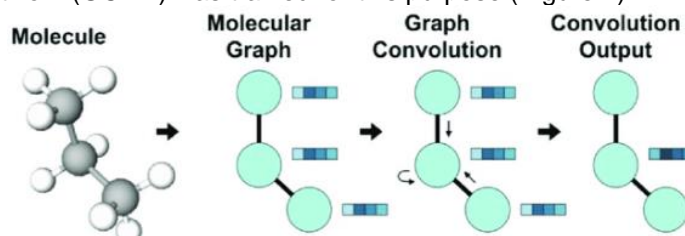

**Figure 1.** Aggregation of information in the molecular graph in GCNN.

The training dataset consisted of 450 molecules with experimentally determined oxidation potentials (V) relative to the calomel electrode in acetonitrile. The following metrics were obtained:  $R^2$  0.80 V, RMSE 0.32 V. Efforts are ongoing to improve the model's performance through the application of transfer learning, with the model being pre-trained on large volumes of theoretical data.

## References

- [1] *Vestnik Rossijskoj akademii nauk* **2021**, 91, 459.
- [2] Public report, Rosatom State Corporation **2022**.
- [3] *Journal of Chemical Theory and Computation* **2023**, 19, 4796.

## Acknowledgements

M.V. Smirnov was supported by a personal fellowship from the Non-commercial Foundation for Support of Science and Education 'INTELLECT'.

# PREDICTION OF INTERFACIAL PROPERTIES AND MICROEMULSION TYPE IN OCTANE-C10E4-WATER SYSTEMS THROUGH DISSIPATIVE PARTICLE DYNAMICS AND THE METHOD OF MOMENTS

*Sopova N.S.<sup>1</sup>, Bochenkov V.E.<sup>1</sup>*

<sup>1</sup> Moscow State University, Moscow, Russia

Student

[ninasopova@mail.ru](mailto:ninasopova@mail.ru)

Nowadays, enhancing the efficiency of hydrocarbon production is a pressing and crucial issue. One of the most effective methods to achieve this goal is by introducing a chemical reagent into the oil-water system that helps reduce interfacial energy. Typically, mixtures of surfactants and alkalis are commonly employed as such reagents. The composition of oil is intricate and varies across different oilfields, underscoring the significance of optimizing the reagent composition and production conditions. Determining the optimal composition of a surfactant reagent through experimental techniques is a complex process that demands considerable time and effort. The advancement of molecular modeling tools and computer technology presents exciting prospects for evaluating the efficacy of surfactant mixtures utilized to lower interfacial tension in the oil-water system. [1]

To predict properties of large molecular systems, one highly effective approach is based on dissipative particle dynamics (DPD) simulations. [2] The primary advantage of the DPD method over Molecular Dynamics simulations and DFT methods lies in its use of fewer computational forces while still delivering precise results. In DPD simulations, all particles are depicted as soft beads that interact through weak repulsive forces. The key parameters defining the chemical properties of these beads and their interactions are the repulsion parameters, which can be derived from experimental data or computed using DFT.

In this study, DPD simulations and the method of moments were employed to predict interfacial properties and microemulsion stability at various conditions for a model octane-C10E4-water system. The 'method of moments' involves calculating the first moment of surface tension, allowing one to estimate the tendency of a system towards the 'oil-in-water' or the 'water-in-oil' emulsion type.[3] The repulsion parameters were fine-tuned based on the experimental values of surface tension. The results demonstrate the capability of this approach to predict conditions for creation the Winsor III type microemulsion.

## References

[1] *IFP Energies nouvelles* **2012**, 67, 969

[2] *J. Phys. Chem. B* **2021**, 125, 3942

[3] *Langmuir* **2013**, 29, 2136



# DEVELOPMENT OF FORCE FIELDS OF METAL DICHALCOGENIDE NANOTUBES

*Stanislavchuk-Abovskiy D.B.<sup>1</sup>, Domnin A.V.<sup>1</sup>, Bandura A.V.<sup>1</sup>*

<sup>1</sup> St. Petersburg State University, Department of Quantum Chemistry, St. Petersburg, Russia  
Student  
[st101520@student.spbu.ru](mailto:st101520@student.spbu.ru)

The significance of studying metal dichalcogenide nanotubes is based on their physical properties, which are determined by the diameter of the tubes, chirality and atomic composition [1]. It is possible to study their physical properties using atomic potential modelling. However, due to the lack of satisfactory force fields in the literature data, there is a need to create them.

An improved method of constructing force fields based on the previous experience of the authors is proposed [2]. The fitting procedure was enhanced through the utilization of machine learning methodologies, enabling the generation of superior-quality force fields. The stages of parameterization of the force field are illustrated in Scheme 1. The properties of layered polytypes of bulk crystals, monolayers, bilayers and nanotubes of small diameters were employed as the training data. At the main stage, genetic optimization of potential parameters was carried out based on the properties of calibration systems. Subsequently, the CatboostRegressor [3] machine learning model was trained on the final population, which was then re-optimized to obtain the final force field. In parallel, a Self-Organizing Map (SOM) algorithm was employed to identify the regions with the highest quality force fields [4].

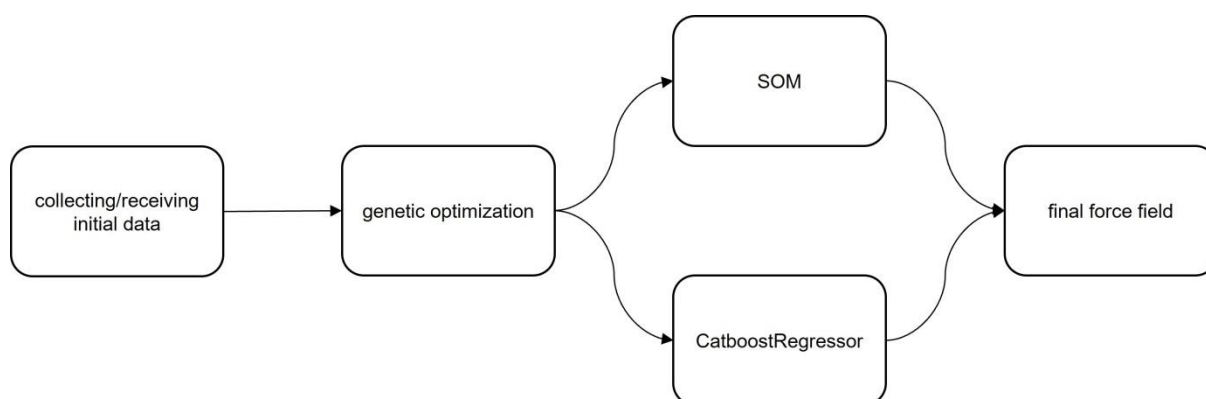

**Scheme 1.** The method of parameterization of the force field.

## References

- [1] Eur Phys 2012, 85, 491.
- [2] Inorg. Chem. **2023**, 68, 1582.
- [3] arXiv. **2019**.
- [4] Proceedings of the IEEE. **1990**. 78. 1464.

## Acknowledgements

This work was supported by the Russian Science Foundation (project No 23-23-00040). The authors highly appreciate the assistance of Saint Petersburg State University's "Computer Center SPBU" for high-performance computing.

# MODELING OF COORDINATION OF METAL AND AMMONIUM CATIONS IN COMPLEXES OF BIS-AZA-18-CROWN-6-CONTAINING DIENONES

*Starostin R.O.*<sup>1,2</sup>, *Freidzon A.Ya.*<sup>1</sup>, *Gromov S.P.*<sup>1,2</sup>, *Melnikov M.Ya.*<sup>2</sup>

<sup>1</sup> *Center of Photochemistry of the Russian Academy of Sciences, FNIC "Crystallography and Photonics" of the Russian Academy of Sciences*

<sup>2</sup> *Faculty of Chemistry of Lomonosov Moscow State University*  
*PhD student*

[star.roman-96@yandex.ru](mailto:star.roman-96@yandex.ru)

Bis-azacrown-containing dienes are of considerable interest as optical molecular sensors due to their ability to provide an optical response when binding organic and inorganic cations [1-2]. The photoinduced recoordination of cations has a great influence on the spectral properties of supramolecular complexes of these compounds, which allows them to be used as photo-switchable molecular devices prototypes [3].

The phenomenon of metal cations recoordination in the cavity of the crown-ether macrocycle, both in the ground and in the excited states, was detected in complexes of monocrown-containing styrene dyes of the guest-host type and investigated by the density functional method [4]. It was shown that the recoordination is associated with a change in the conformation of the macrocycle, because of which the cation is either bound to all heteroatoms of the azacrown-ether residue, and the crown-ether nitrogen atom is excluded from the conjugation chain, or is bound only to oxygen atoms, and the crown-ether nitrogen atom remains in the conjugation chain. The first type of conformations leads to a hypsochromic shift of the absorption band of the complex, and for the second type, the absorption spectrum differs little from the spectrum of the free dye. It has also been shown that the tendency to coordinate depends on the size of the cation and the cavity of the macrocycle, as well as on the ion charge. The solvation of the cation has a key effect on coordination.

In this work, bis-aza-18-crown-6-containing dienones (Scheme 1) and their complexes with  $K^+$ ,  $Mg^{2+}$ ,  $Ca^{2+}$ ,  $EtNH_3^+$  cations were studied by DFT and TDDFT.

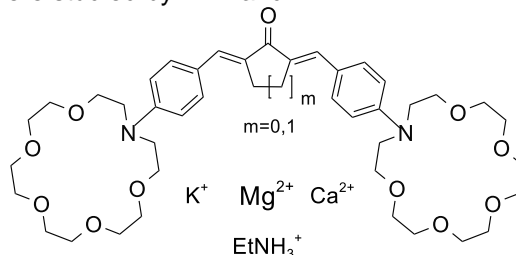

**Scheme 1.** The structure of bis-azacrown-containing dienones of the cycloalkane series

Various solvate forms of their complexes with 1:1, 1:2, 1:3 stoichiometry have been studied. Coordination was studied both on the surface of the ground  $S_0$  and excited  $S_1$  states. It was found that the relative depth of the minima of both types of conformers is determined by the surface charge density on the cation and the geometric correspondence between the cation and the macrocycle cavity.

It was found that the mechanism of recoordination changes when the ammonium cation binds. The ammonium cation can be coordinated by the N and O atoms of the macrocycle (NH), or only by the O (OH) atoms. Both options can be combined with the orientation of the chromophore group and the ammonium cation on one or on different sides relative to the cavity of the macrocycle. The driving force of the process is a decrease in the energy of the system due to the transition between NH and OH forms with the same steric orientation of the cation, while maintaining the axial conformation of the macrocycle.

## References

- [1] *J. Photochem. Photobiol. A.* **2020**, *402*, 112801
- [2] *Journal of Fluorescence.* **2002**, *12*, 1
- [3] *Mendeleev Commun.* **2023**, *33*, 380
- [4] *Russ. Chem. Bull.* **2008**, *57*, 2045

## Acknowledgements

This work was supported by the Russian Science Foundation (project No 22-13-00064).

# THE ACTIVITY AND STABILITY OF FeN<sub>4</sub>-DOPED CARBONS IN OXYGEN ELECTROREDUCTION. STRUCTURE – REACTIVITY RELATIONSHIP

*Stentsova V.V.<sup>1</sup>, Kuzmin A.V.<sup>2</sup>*

<sup>1</sup> Irkutsk State University, Irkutsk, Russia

<sup>2</sup> A.E. Favorsky Irkutsk Institute of Chemistry SB RAS, Irkutsk, Russia  
Student

[Stenzer-v@ya.ru](mailto:Stenzer-v@ya.ru)

Oxygen reduction reaction (ORR) catalysts based on non-precious metal (Fe, Co, Cu, Sn, etc.) doped nitrogen anchored carbon nanomaterials (NCMs) attract much attention due to their low cost, high activity and selectivity [1]. Currently, iron, nitrogen-doped NCMs are considered as one of the most promising catalysts for ORR in both acidic and alkaline media, where the overpotential  $\eta_{\text{ORR}}$  can be as low as 0.35 V at 0.05 at. % metal content [2,3]. The present theoretical study devoted to the influence of active center structure on the reactivity of FeN<sub>4</sub>-doped graphene and carbon nanotubes (CNTs) in ORR, as well as the stability of Fe center to carbon monoxide poisoning.

The (6,6)-armchair and (12,0)-zigzag CNTs with different orientation of FeN<sub>4</sub> fragment along CNT axis of symmetry were chosen as model structures. The reactivity and mechanism were studied using UrevPBE0-D3(C-PCM,Water)/Def2-TZVP//UrevPBE-D3(C-PCM,Water)/Def2-SVP. It is found that the binding energy of O<sub>2</sub> with Fe atom correlates well with the radical susceptibility indices of the iron atom  $f_{\text{Fe}^0}$  ( $r = -0.904$ ,  $n = 5$ ,  $s^0 = 0.02$ ) and the positive charge on it ( $r = -0.844$ ,  $n = 5$ ,  $s^0 = 0.04$ ). The adsorption of CO on the Fe center of zigzag CNTs was found to be endothermic due to weak electron-acceptor properties of the metal. The values of the charge change on Fe ( $\Delta q < 0$ ) and the Mayer bond order of Fe-C in \*CO adsorbate for all studied Fe-N<sub>4</sub>/NCMs indicate the predominance of  $\sigma$ -bonding over  $\pi$ -backbonding as a result of carbon lone pair donation to the metal, which is in agreement with the metal electrophilicity indices,  $f_{\text{Fe}^-}$  ( $r = 0.991$ ,  $n = 5$ ,  $s^0 = 0.07$ ), and nucleophilicity,  $f_{\text{Fe}^+}$  ( $r = 0.329$ ,  $n = 5$ ,  $s^0 = 0.04$ ) [4].

The analysis of ORR free energy profiles revealed the activity of Fe center increases from zigzag to armchair CNT as the support, and is maximal for CNT<sub>a2</sub> with the skew oriented FeN<sub>4</sub> fragment relative to the CNT axis of symmetry ( $\eta_{\text{ORR}} = 0.39$  V, Fig. 1). The potential-determining step (PDS) for all CNT-based structures is the reduction of HO\* intermediate (O<sub>2</sub>\* in case of graphene as the support). The catalytic activity of the vinyl group carbon atoms covalently bonded to the FeN<sub>4</sub> motif is limited by chemisorption of O<sub>2</sub>. As the result of irreversible CO poisoning of Fe center of the most active FeN<sub>4</sub>-doped armchair CNTs, O<sub>2</sub> electroreduction may take place at the C<sub>2</sub> site. Depending on the orientation of Fe(CO)N<sub>4</sub> motif along CNT axis of symmetry, the overpotential  $\eta_{\text{ORR}}$  decreases from 0.71 V (CNT<sub>a1</sub>) to 0.49 V (CNT<sub>a2</sub>), the potential-determining step is the reduction of epoxy O\*\* or dihydroxy 2HO\* adsorbates to HO\*, respectively.

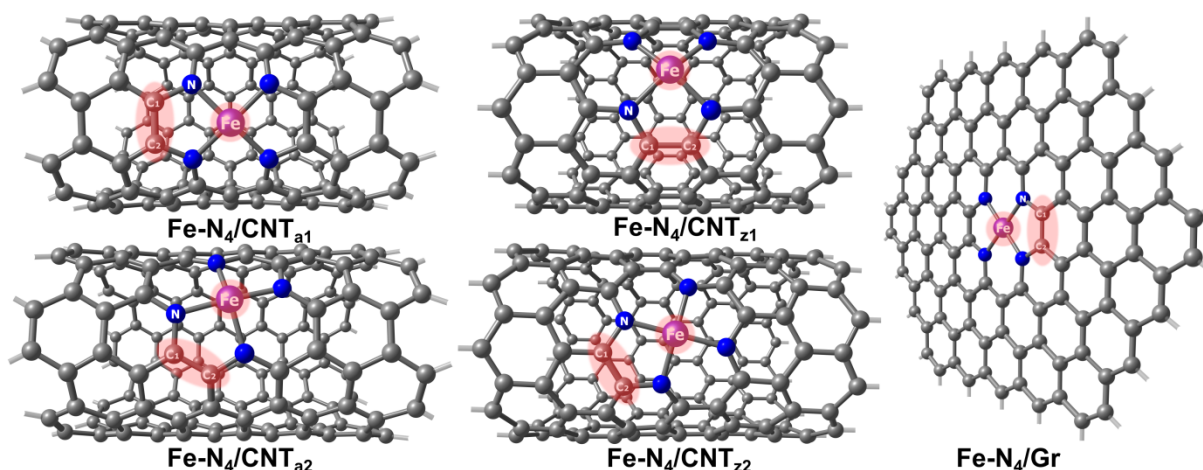

**Figure 1.** Model structures of Fe-N<sub>4</sub>/NCM (ORR active centers are highlighted in red)

## References

- [1] *Joule* **2020**, *4*, 33
- [2] *ACS Appl. Nano Mater.* **2019**, *2*, 3538
- [3] *Catalysts* **2015**, *5*, 1167
- [4] *Mol. Catal.* **2024**, *560*, 114123

# INTERACTION OF SUPERALKALIS $NK_3M$ ( $M = Li, Na, K$ ) WITH $CO_2$ : A THEORETICAL STUDY

*Svinkin N.A.<sup>1</sup>, Kondratev V.M.<sup>1</sup>, Bolshakov A.D.<sup>1,2</sup>, Petrushenko I.K.<sup>3</sup>*

<sup>1</sup> Alferov University, St. Petersburg, Russia

<sup>2</sup> St. Petersburg University, St. Petersburg, Russia

<sup>3</sup> Irkutsk National Research Technical University, Irkutsk, Russia

Student

[nik-svinkin@mail.ru](mailto:nik-svinkin@mail.ru)

Reducing agents with a low first ionization potential ( $IP^1$ ) play an important role in the chemical industry and materials science. In 1982, G. L. Gutsev and A. I. Boldyrev showed that in some polyatomic compounds  $IP^1$  can be lower than  $IP^1$  of alkali metals (3.89 eV) due to collective effects, such structures are called "superalkalis". Strong reducing properties of superalkalis can be used to activate  $CO_2$  and  $N_2$ , to store hydrogen, and to capture inert gases [1].

The stability and electronic structure of superalkalis studied in this work was reported earlier [2]. In addition, the possibility of activating  $CO_2$  molecules using homoligand superalkalis was considered in [3]. There are also works devoted to the study of the interaction of superalkalis  $NM_4$  ( $M = Li, Na, K$ ) with a carbon dioxide molecule [4]. This paper presents the results of the study of the interaction of superalkalis  $NK_3M$  ( $M = Li, Na, K$ ) with  $CO_2$  molecules.

Using the DFT approach wB97X-D3/6-311+G(d,p), the equilibrium geometric configurations of  $NK_3M+CO_2$  complexes are calculated, which are characterized by the change in the bond angle C–O–C and the C–O bond length atoms in the  $CO_2$  molecule to values characteristic of the  $CO_2$ -anion (compared with non-interacting  $NK_3M$  and  $CO_2$ ). Two isomers of superalkalis with a carbon dioxide molecule of the form  $NK_3M+CO_2$  have been obtained (Fig. 1). In addition, the equilibrium configurations of the studied superalkalis and their cations have been calculated. The results of calculating the charge and spin density distribution before and after the interaction are presented, showing the transition of an electron from a superalkali to a  $CO_2$  molecule. The energy of the interaction of superalkalis with  $CO_2$  was also estimated using the IGMH method. It has been shown that the interaction between superalkali and  $CO_2$  is weaker than the bond of atoms inside the superalkali. The stability of the complexes at temperatures of 77 K and 300 K has been estimated using the AIMD method. Based on the calculation, conclusions have been drawn about the possibility of using superalkalis  $NK_3M$  to activate carbon dioxide molecules without destructive consequences for the superalkali itself, which is especially important from the point of view of minimizing the human carbon footprint and solving environmental and energy issues.

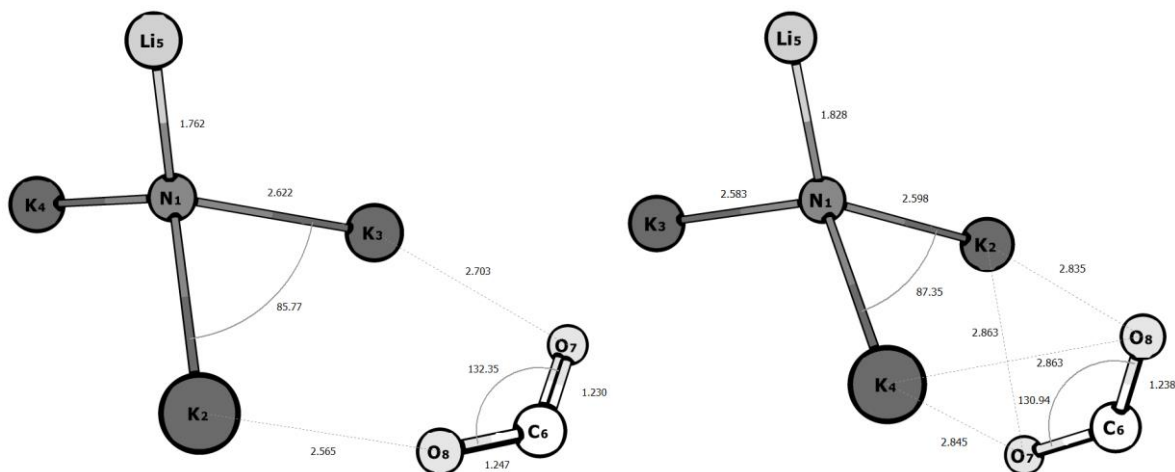

**Fig. 1.** Calculated geometries for the two isomers of the  $NK_3M+CO_2$  complexes; here  $M = Li$ , but for  $M = Na, K$  the same structure is obtained

## References

- [1] *Chemistry–A European Journal*. **2019**, 25, 9568-9579
- [2] *Physics Letters A*. **2019**, 383, 125952
- [3] *International Journal of Quantum Chemistry* **2018**, 118, e25598
- [4] *Молодежный Вестник ИРГТУ* **2023**, 13, 576-582

## METHOD DEVELOPMENT IN TAAR1 AGONIST STRUCTURE-BASED DRUG DESIGN

*Tatarinov I.A.<sup>1</sup>, Kalinin S.A.<sup>1</sup>, Dar'in D.V.<sup>1</sup>*

<sup>1</sup> St. Petersburg State University, St. Petersburg, Russia  
[st094545@student.spbu.ru](mailto:st094545@student.spbu.ru)

TAAR1 (Trace Amine-Associated Receptor 1) has emerged as a significant drug target due to its role in neuromodulation and potential implications for treating psychiatric and neurodegenerative disorders. Several promising compounds targeting TAAR1 are currently in clinical trials, underscoring its therapeutic potential [1]. Historically, the lack of high-resolution crystallographic data has hindered structure-based drug design for this receptor. However, the recent publication of the cryo-EM structure of TAAR1 has marked a pivotal advance, enabling us to explore the design of new ligands with enhanced specificity and efficacy [2].

Utilizing this newly available structural information and building on our experimental data, we have developed a refined model employing a suite of computational techniques, including Glide Docking Score, Induced Fit Docking Score, MM-GBSA, metadynamics, QM/MM-PBSA, and FEP+. These methods are critical for accurately predicting the binding poses and ligand-receptor interactions, which are challenging with current force fields or DFT. Moreover, quantifying pi-pi stacking and dispersion interactions requires the use of more sophisticated, albeit costly, methods [3]. These techniques have been instrumental in correlating the experimental results with our theoretical models, significantly enhancing our understanding of ligand-receptor interactions.

Our findings have enabled us to rank virtual ligand libraries and guide the optimization of experimental hit compounds. This work represents an early rational approach to discovering TAAR1 agonists, offering a novel pathway for the development of innovative therapeutic agents for the CNS.

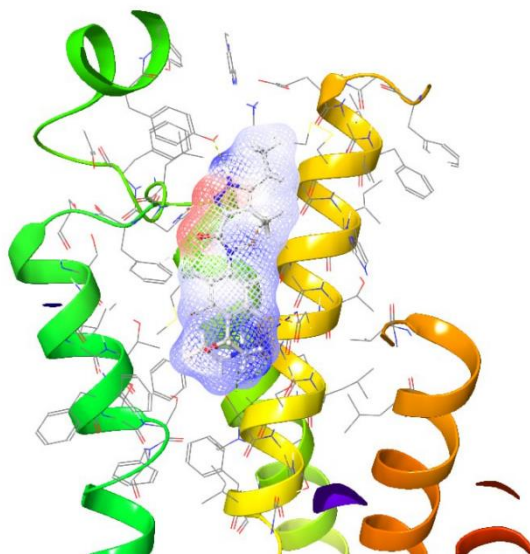

**Scheme 1.** QM/MM optimized pose for one an investigational TAAR1 ligand RO-688945.

### References

- [1] Expert Opin. Investig. Drugs **2023**, 32(5), 401
- [2] Nature **2023**, 624, 663
- [3] Front. Mol. Biosci. **2022**, 9, 899805

### Acknowledgements

This work was supported by the Russian Science Foundation (project № 19-76-30008-P).

# STUDYING NITROGEN-CONTAINING HETEROCYCLES WITH STYRYL SUBSTITUTES BY QUANTUM-CHEMICAL AND SPECTROPHOTOMETRIC METHOD

*Timoshchuk K.V.<sup>1</sup>, Andoskin P.A.<sup>2</sup>, Semenov K.N.<sup>1,2</sup>*

<sup>1</sup>St. Petersburg State Technological Institute (Technical University), Russia, St. Petersburg, Department of Physical Chemistry

<sup>2</sup>First St. Petersburg State Medical University named after academician I.P. Pavlova, Russia, St. Petersburg, Department of General and Bioorganic Chemistry

PhD student

[kirill.timoshchuk99@mail.ru](mailto:kirill.timoshchuk99@mail.ru)

## Introduction.

Antitumor drugs based on nitrogen-containing heterocycles with styryl substituents are promising objects in medicine; they can interact with various biological targets of tumor cells [1]. Such drugs can be thiadiazolo[3,2a]pyrimidin-4-ium derivatives, which have pronounced cytostatic properties and are also luminescent sources. This paper presents the results of a study of the physicochemical properties of 2-amino-5-(4-(dimethylamino)styryl)-7-methyl[1,3,4]thiadiazolo[3,2a]pyrimidin-4-ium perchlorate (thiadiazolo derivative [3,2 a]pyrimidin-4-ium).

## Purpose.

The purpose of the work is a quantum chemical calculation of the electronic structure, which made it possible to obtain the distribution of electron density, as well as an experimental study of the binding of the compound to human serum albumin (HSA) and DNA.

## Materials and methods.

To calculate the electronic structure, the ORCA software package with the O3LYP functionality and the 6-31g basis was used.

The binding of the compound to HSA was studied by isothermal titration calorimetry (ITC) using a TA Instruments Nano ITC 2G microcalorimeter (USA) equipped with a 1 ml gold measuring cell.

The study of binding to DNA was carried out using the spectrophotometric method at a temperature of 298.15 K. The concentration of the test substance varied in the concentration range of 1–150  $\mu\text{M}$ , the DNA concentration was 3.1  $\mu\text{M}$ . Binding experiments were performed in saline.

## Results.

Using quantum chemical calculations, the geometry was optimized and the spatial distribution of the charge density surface was obtained, which are presented in Figure 1.

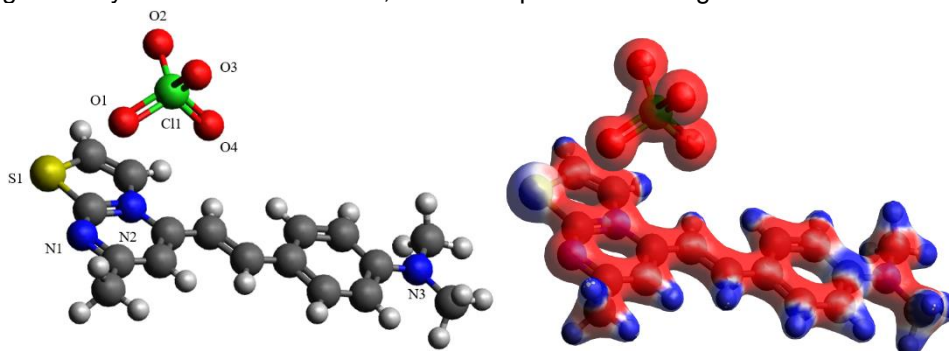

**Fig. 1.** Molecule of thiadiazolo[3,2 a]pyrimidin-4-ium derivative (left) and electron density distribution (right).

As can be seen from the results, a significant negative charge is concentrated on the atoms to which the perchlorate ion is close.

As a result of the DNA binding experiment, the binding constant is  $5,7 \cdot 10^5 \text{ M}^{-1}$ .

As a result of the binding experiment with HSA, we can say that this experiment is consistent with molecular dynamics and the binding constant is  $1,48 \cdot 10^7 \text{ M}^{-1}$ .

## Conclusions.

As a result of the work performed, the electron density distribution was calculated; The binding constants of the compound to DNA and HSA were obtained.

## References:

- [1] Bhurta, D., & Bharate, S. B. Styryl Group, a Friend or Foe in Medicinal Chemistry // *ChemMedChem* (Vol. 17, Issue 7). John Wiley and Sons Ltd. – 2022. – Vol. 17. – № 7.

# INVESTIGATION OF MUTUAL INFLUENCE OF NH...N HYDROGEN BONDS IN AMIDINE SELF-ASSOCIATES BY MEANS OF QUANTUM CHEMISTRY

*Titova A.A.,<sup>1</sup> Skakun M.A.,<sup>1</sup> Tupikina E. Yu.<sup>1</sup>*

<sup>1</sup> St. Petersburg State University, St. Petersburg, Russia

Master's student

[aatitova1210@gmail.com](mailto:aatitova1210@gmail.com)

Hydrogen bonds are often used for association of polymer blocks in design of modern supramolecular materials [1]. Important and perspective types of such polymers are materials with adaptive properties, for example, recovering ability after changes in temperature or pressure. It's necessary that double hydrogen bonds, unlike single hydrogen bond, have a mutual influence – show cooperative (enhancing) and anti-cooperative (weakening) effects [2]. Besides that, different electron-donating (EDG) and electron-withdrawing (EWG) groups located in the proximity of hydrogen bonds also affect the physical and chemical properties of polymers.

So, before synthesis of adaptive materials with non-covalent interactions, it's necessary to estimate cooperative/anticooperative effects and consider influence of substituents theoretically. The simplest examples of association using multiple hydrogen bonds are dimers of substituted amidines, in which NH...N hydrogen bonds are realized (Figure 1). Such type of hydrogen bonding is quite common and has moderate strength. The investigation of these hydrogen bonds can be done systematically using quantum chemical calculations.

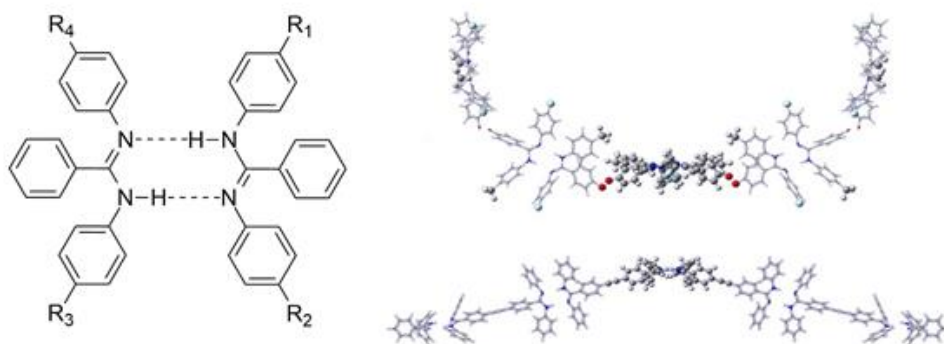

**Figure 1.** Examples of chemical structures of investigated dimers and oligomers with various substituents (-F, -CF<sub>3</sub>, -CH<sub>3</sub>, -OCH<sub>3</sub>, -CN etc.).

Our main goal was to analyze changes in the geometry, topology and NMR parameters of NH...N «head-to-tail» hydrogen bonds in investigated dimers and oligomers, which can be potentially used as building blocks in polymers. Also, we estimated the influence of the different substituents and identified the cooperative/anticooperative behavior of the hydrogen bonds.

Quantum chemical calculations of geometry and NMR parameters of dimers and oligomers were performed with Gaussian16 software. All structures were optimized and checked for the absence of imaginary frequencies. NMR parameters were calculated at the same of level of theory using GIAO approach.

## References

- [1] *R. Soc. Open Sci.* **2018**, 5
- [2] *Theor. Chem. Acc.* **2013**, 132, 1–10

## Acknowledgements

This work was supported by the Russian Science Foundation (project No 23-13-00095).

## MOLECULAR PARAMETER CHARACTERIZING NSD-PV IN THE $^{29}\text{Si}^{16}\text{O}^+$ CATION

*Turchenko P.D.*<sup>1,2</sup>, *Skripnikov L.V.*<sup>1,2</sup>

<sup>1</sup> Petersburg Nuclear Physics Institute named by B.P. Konstantinov of National Research Centre “Kurchatov Institute”, Advanced Development Division, Gatchina, Russia

<sup>2</sup> St. Petersburg State University, Department of Physics, St. Petersburg, Russia  
Student

[p.d.turchenko@vk.com](mailto:p.d.turchenko@vk.com)

In a diatomic molecule, the properties of parity violation (PV) are determined by nuclear-spin-dependent interactions (NSD-PV). Studying these will aid in refining the theory of interactions in atomic nuclei that break spatial invariance. In recent years, experiments to detect PV properties have been initiated — effects were measured in the atom  $^{133}\text{Cs}$  [1] and in the molecule  $^{138}\text{Ba}^{19}\text{F}$  (limitation obtained for the nucleus  $^{19}\text{F}$ ) [2], and a series of experiments is planned [3—5]. A characteristic feature of diatomic molecules is the presence of closely spaced rotational levels of opposite parity [6,7], which among other factors influenced the choice of  $^{29}\text{Si}^{16}\text{O}^+$  cation as the system under study for the upcoming experiment [5].

In the current work, based on a fully relativistic description of many-electron systems, the value of the molecular parameter characterizing NSD-PV in the cation  $^{29}\text{Si}^{16}\text{O}^+$  was calculated, which is necessary for the interpretation of the experiment [5]. In solving this problem, various contributions and their accuracy stemming from the variation in basis sets of the single-electron wave function, the number, and the degree of electron correlation were considered. Non-adiabatic contributions are currently being studied.

### References

- [1] *Science* **1997**, 275, 1759
- [2] *Phys. Rev. Lett.* **2018**, 120, 142501
- [3] *Hyperfine Interact.* **2013**, 214, 163
- [4] *arXiv* **2014**, 1412, 1245v1
- [5] *arXiv* **2023**, 2310, 11192v1
- [6] *Zh. Eksp. Teor. Fiz.* **1978**, 75, 1208
- [7] *Phys. Lett. A* **1985**, 110, 121

### Acknowledgements

This work was supported by the Russian Science Foundation (project No 19-72-10019-P) and the “BASIS” grant (project No 21-1-2-47-4).



## THE 3D MODEL OF THE MENDELEEV'S TABLE

*Turyansky Y.M.<sup>1</sup>, Kudan P.V.<sup>2</sup>*

<sup>1</sup> Moscow State University, Moscow, Russia

<sup>2</sup> FizLabPribor, Moscow, Russia

Student

[yarostur1@gmail.com](mailto:yarostur1@gmail.com)

Previously, the three-dimensional model of the Mendeleev's table of chemical elements in the shape of cylinder (displaying information on periods and s-elements) and three planes (displaying information on *p*, *d* and *f*-elements) was presented by the authors at the International Scientific Forum "Lomonosov-2024" [1]:

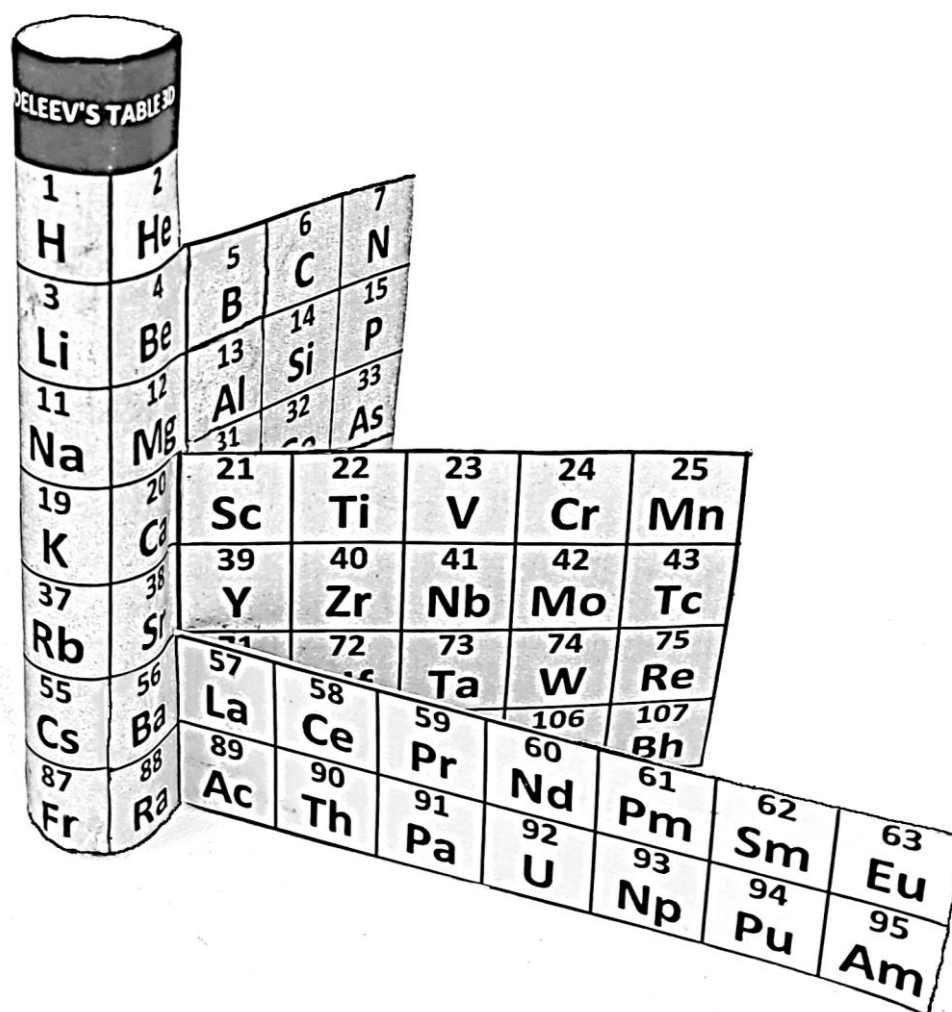

**Scheme 1.** The three-dimensional model of the Mendeleev's table of chemical elements.

In this report the full compatibility of the geometry of the three-dimensional model to the conclusions of the IUPAC Group 3 project on the possibility to add Lu and Lr to Sc and Y into the group 3 basing on the quantum mechanical considerations [2] was demonstrated. Also, the full compatibility of the geometry of the three-dimensional model to the quantum mechanical classification of He as s-element [3] was discussed.

### References

[1] *Mat. Intern. You. Sci. Forum "LOMONOSOV" 2024*, in print (in Russian)

[2] *Chem. Intern.* **2021**, 43, 1, 31

[3] *Quantum Mechanics: Non-relativistic Theory*, Pergamon Press, Oxford **1965**, 255

# CONVOLUTIONAL NEURAL NETWORK FOR THE AUTOMATED ANALYSIS OF X-RAY PHOTOELECTRON SPECTRA

*Vakhrushev A.A.<sup>1</sup>, Matveev A.V.<sup>1</sup> Nartova A.V.<sup>1,2</sup>*

<sup>1</sup> Novosibirsk State University, Novosibirsk, Russia

<sup>2</sup> Boreskov Institute of Catalysis, Novosibirsk, Russia  
Student

[a.vakhrushev1@g.nsu.ru](mailto:a.vakhrushev1@g.nsu.ru)

X-ray photoelectron spectroscopy (XPS) is an indispensable technique for the quantitative determination of sample composition and electronic state of elements applied in different research fields. Current methods of analyzing XPS spectra rely on experience and knowledge of spectroscopists and usually are conducted manually. Improvements of X-ray sources advance the quality of experimental data and allow one to obtain larger datasets. However large datasets are quite difficult to process manually. Despite becoming XPS instruments more automated to fit both the inelastic scattering and the line shapes of the peak regions is a challenge, that generally involves task of peak detection. Classical algorithms of spectra analysis may cause a significant error in peak detection and fitting, and therefore cannot be used in automatization task. Recently, machine learning based algorithms have been successfully applied to data analysis in wide range of physical methods [1, 2]. This work is dedicated to development of framework based on convolutional neural network (CNN) model for fast XPS data analysis.

The task of XPS spectrum analysis in the present work is split to several phases (figure 1). At first stage CNN model detects peak areas and maxima in XP spectra. The next stages are calculating background in detected peak areas and fitting line shapes according to detected maxima. Data for training was obtained by the scientific group at the BIC SB RAS. Additional algorithm was developed to generate artificial spectra. The design of model architecture, training and testing was performed using PyTorch in Python.

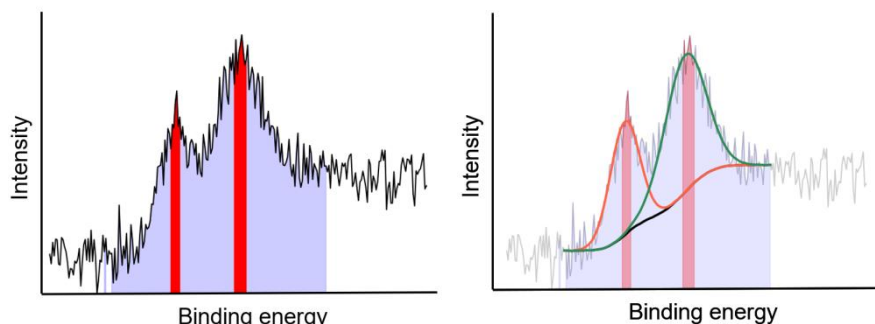

**Figure 1.** Phases of detecting maxima (left panel) and fitting peak shapes and background (right panel).

## References

- [1] *Kinetics and Catalysis*. **2023**, 64-4, 457
- [2] *Anal. Chem.* **2020**, 92, 588

## Acknowledgements

This work was supported by the Ministry of Science and Higher Education of the Russian Federation within the governmental order for Boreskov Institute of Catalysis (project FWUR-2024-0032) and Priority 2030 strategic academic leadership program at Novosibirsk State University.

# DIAMANE OXIDE. INVESTIGATION OF STRUCTURE, STABILITY AND ELECTRONIC PROPERTIES

*Varlamova L.A.*<sup>1</sup>, *Erohin S.V.*<sup>1</sup>, *Larionov K.V.*<sup>1</sup>, *Sorokin P.B.*<sup>1</sup>

<sup>1</sup> National University of Science and Technology MISIS, Moscow, Russia

Postgraduate

[varlamova.la@misis.ru](mailto:varlamova.la@misis.ru)

Diamane, a quasi-two-dimensional carbon film with a diamond-like structure boasts extraordinary mechanical properties rendering it a promising as a filler for composite materials. Its electronic properties also hold potential application in optics and electronics [1].

The synthesis of two-dimensional diamond-like films directly from multilayer graphene requires high temperatures and pressures. However, the thinnest films, such as bilayer diamane, prove challenging to stabilize and require precursor materials for synthesis. This process, known as chemically induced phase transition entails alterations in the surface energy of two-dimensional carbon structures through the adsorption of various functional groups onto graphene surface. These groups induce a transformation in the hybridization of carbon atoms from  $sp^2$  to  $sp^3$ , leading to the formation of carbon bonds between graphene sheets and the production of a diamond-like film.

The bonding of the bigraphene sheets and the resulting geometry of the film, whether cubic or hexagonal diamond structure, hinge upon the initial orientation of the sheets relative to each other and the arrangement of deposited functional groups on the surface.

In this work, we examined the structure, stability and electronic properties of diamane films functionalized with hydroxyl and peroxide groups as well as hydrogen atoms [2]. We considered the deposition of these groups on AA' stacked bilayer graphene, and the deposition of hydroxyls and hydrogen atoms on AB bilayer graphene. It was shown that the deposition of oxygen in the epoxide form did not contribute significantly to the surface energy changes, thereby preventing further binding. The stability of such films under different temperature and pressure conditions was studied, revealing that diamond films coated with a mixture of hydrogen and hydroxyl groups are stable at low temperatures and pressure of about 35 GPa, aligning well with the available experimental data [3,4]. Additionally, we examined the electronic properties of these diamond films and elucidated how they vary with changes in coatings stoichiometry.

## References

- [1] Sorokin, P. B.; Yakobson, B. I. Two-Dimensional Diamond—Diamane: Current State and Further Prospects. *Nano Lett.* 2021, 21 (13), 5475–5484.
- [2] Varlamova, L. A.; Erohin, S. V.; Larionov, K. V.; Sorokin, P. B. Diamane Oxide. Two-Dimensional Film with Mixed Coverage and a Variety of Electronic Properties. *J. Phys. Chem. Lett.* 2022, 11383–11390.
- [3] Barboza, A. P. M.; Guimaraes, M. H. D.; Massote, D. V. P.; Campos, L. C.; Barbosa Neto, N. M.; Cancado, L. G.; Lacerda, R. G.; Chacham, H.; Mazzoni, M. S. C.; Neves, B. R. A. Room-Temperature Compression-Induced Diamondization of Few-Layer Graphene. *Adv. Mater.* 2011, 23 (27), 3014–3017.
- [4] Tao, Z.; Du, J.; Qi, Z.; Ni, K.; Jiang, S.; Zhu, Y. Raman Spectroscopy Study of  $Sp^2$  to  $Sp^3$  Transition in Bilayer Graphene under High Pressures. *Appl. Phys. Lett.* 2020, 116 (13), 133101.

## Acknowledgements

This work was supported by the Ministry of Science and Higher Education of the Russian Federation in the framework of Increase Competitiveness Program of NUST "MISIS" (No. K6–2022–041).

# THEORETICAL STUDY OF «FLIPPING» METALATION OF 4-DIMETHYLAMINOPYRIDINE

*Verkhov V.A.*<sup>1</sup>, *Gubanova A.N.*<sup>1</sup>, *Antonov A.S.*<sup>2</sup>

<sup>1</sup> St. Petersburg State University, St. Petersburg, Russia

<sup>2</sup> University of Regensburg, Regensburg, Germany

PhD student

[valeriiverhov@mail.ru](mailto:valeriiverhov@mail.ru)

In the 4-dimethylaminopyridine (DMAP) molecule, conjugation of the NMe<sub>2</sub> group leads to suppression of the DOM-effect, as a result of which lithiation occurs only at position 2(6) [1]. In this work, we showed that the introduction of a bulky substituent makes it possible to sterically block positions 2(6), which opens the way to selective lithiation of positions 3(5).

Altogether, quaternization of the pyridine nitrogen atom in general leads to the strengthening of the conjugation of the dimethylamino group with the heteroring and disables its ability to coordinate the organometallic reagent, which leaves no room for the manifestation of the DOM-effect. Thus, chemical interactions of DMAP and its 1-substituted derivatives (F<sub>3</sub>B-DMAP, Me<sub>3</sub>Si-DMAP, *i*-Pr<sub>3</sub>Si-DMAP, etc.) molecules with organolithium reagents are controlled only by acidity and steric accessibility of corresponding CH-bond.

We have developed a new method for assessing the steric accessibility of various positions of the pyridine ring. This method consists of calculating the isosurface region of electron density 0.001 a.u., limited by the electron density basin of the atom under study. The boundaries of the basin are set by the conditions of zero flux of the electron density gradient (Fig. 1). Thus, in DMAP and F<sub>3</sub>B-DMAP molecules protons at positions 2(6) are more accessible for organometallic reagent. When moving to Me<sub>3</sub>Si-DMAP and *i*-Pr<sub>3</sub>Si-DMAP, position 3(5) becomes more sterically accessible. In general, the larger the substituent at position 1 becomes, the more preferable position 3(5) becomes. Moreover, the organolithium reagent (*t*-BuLi·THF<sub>2</sub>) is able to coordinate to the aza group of DMAP, thereby sterically blocking the 2(6) positions for the metalation reaction.

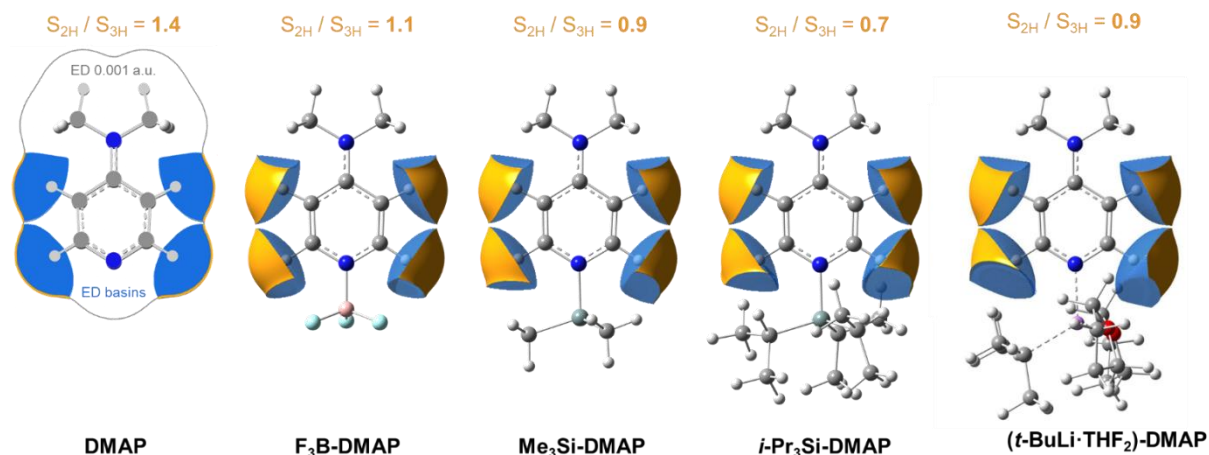

**Figure 1.** The accessible surface area of pyridine protons in DMAP and its 1-derivatives. The relative ratio of accessible surface areas of C2-H and C3-H is given.

Finally, in addition to steric accessibility, the strength and polarity of CH bonds plays a key role in metalation reactions. CH-polarity has been estimated by the distance between the minima of electron density and electrostatic potential, along the bond path. It has been shown that quaternization of the pyridine nitrogen atom increases the polarity of all CH bonds, especially the C2-H bond.

## References

[1] *Chem. Rev.* **1997**, *97*, 721

## Acknowledgements

This work was supported by the Russian Science Foundation (project No 21-73-10040).

## PRODUCED JET-FUEL FROM RENEWABLE HYDROCARBON FEEDSTOCK

*Zaikin M.A.*

In 2016 the Council of International Civil Aviation Organization (ICAO) implemented a program to reduce greenhouse gas emissions by using aviation fuels produced from renewable raw materials in the Carbon Compensation and Reduction System for International Aviation (CORSA). The purpose of this program decrease CO<sub>2</sub> emissions with an annual increase in air traffic. These requirements it is challenge for processing industries in Russia, because they are completely focused on the processing of petroleum raw materials, unlike European and Asian countries, which are more effective in recycling of household, food and industrial waste. One of the alternative types of raw materials, including those belonging to the “renewable” category - fat-and-oil raw materials, represented by used cooking oil (UCO), animal and technical fats, tall oils of the timber processing industry. Vegetable oils (sunflower, rapeseed oil, etc.) cannot be classified as “renewable”, since they do not provide a sufficient level of reduction in greenhouse gas emissions over the entire period of their existence.

Jet aviation fuel produced from renewable raw materials turn into component of sustainable aviation fuel (SAF). Commercial fuel produced by mixing fractions of petroleum fuels and renewable fuels, which is called SAF. The regulatory framework for the production of SAF in European countries is the ASTM D7566 and D1655 standards, which describing both methods of producing fuels from renewable raw materials and the permissible proportion of mixing with petroleum fuels.

One of the most affordable methods for Russian industry it is the hydrotreating of fat-and-oil raw materials. At the same time, hydrogenation of esters and acids, which are part of vegetable oils and fats, has long been familiar abroad in the production of biodiesel or hydrogenated vegetable oil (HVO). Diesel fuel obtained from fat-and-oil raw materials has some limitations - low low-temperature properties and high cost of raw materials for this production. At the same time, the production of kerosene fuel look like more positive with the assistance of creation a new regulatory framework by CORSA.

At this moment, there are two main problems in the domestic processing industry – the lack of a regulatory framework for this type of fuels and lack of technological solutions for new production facilities. In this connection, advanced achievements were studied in this way, carried out research work on the processing of all types of fat-and-oil raw materials and prepared a basis for national standards and for new production facilities.

The hydroprocessing process can be done sequentially from the stages of hydrogenation or hydrodeoxygenation of oxygen-containing compounds and then follow hydrocracking stage (Fig.1)

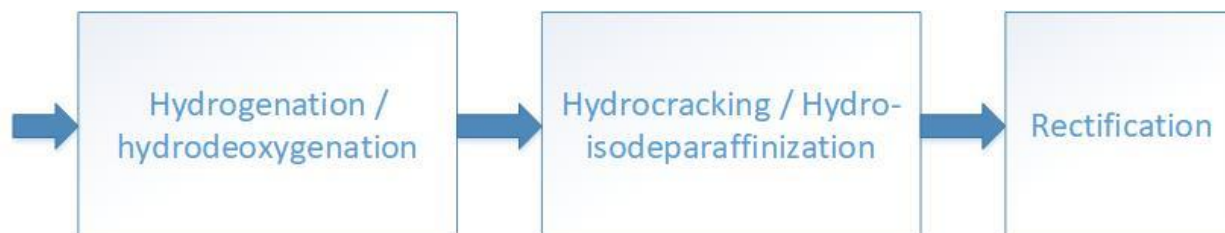

Figure 1. Block-scheme of conversion fat and oil raw materials

At the first stage received the maximum yield of paraffin compounds cracking C-O bonds. Hydrocarbon gas and water are also formed. Tested industrial catalyst for hydrotreating diesel, which containing Co and Mo molecules on Al<sub>2</sub>O<sub>3</sub>. Hydrogenation of fat-and-oil raw go on with good conditions - temperature not more than 360 ° C and a pressure not more than 5 MPa. The main difficulty in processing fat-and-oil raw materials at this stage is the high content of alkaline and alkaline earth metals with large quantities.

After second stage received a mixture of hydrocarbons, characterized by high low-temperature and operational properties due to a high proportion of hydrocarbons of an isomeric structure, as well as corresponding to the criterion of renewability, i.e. it has lower greenhouse gas emissions. Various catalytic systems can be used for hydroisodeparaffination, both containing platinum in their composition and zeolite catalysts for the isodeparaffination of diesel fuel. The choice of a catalyst for the second stage of the process determines the degree of cracking and, as a result, the fractional composition of the resulting mixture. The research work was based on a platinum-containing catalyst of its own design, which allows to obtain the maximum yield of the kerosene fraction, provided that the high selectivity of the isomerization reaction is maintained. The technological parameters of waterproofing are close to the first stage – the temperature does not exceed 360 ° C, and the pressure does not exceed 5 MPa.

Gasoline, kerosene and diesel fractions obtained after the rectification of this mixture can be used as environmentally friendly additives to petroleum fuels obtained from crude oil at domestic refineries. A distinctive feature of the resulting fuel is the absence of aromatic compounds, as well as the exclusion of sulfur and nitrogenous compounds in processed products, due to their absence in the raw materials.

Based on the above, it can be said that the hydroprocessing of fat-and-oil raw materials into fuel has a high level of technological readiness and can be considered for implementation at the processing facilities of domestic enterprises as an environmental project. The fuels produced by this technology are characterized by high environmental and operational properties and are not inferior to fuels obtained from petroleum raw materials.

# USE OF QUANTUM CHEMICAL CALCULATIONS IN THE EXTRACTION OF NOBLE METALS

Zubricheva D.V., Tikhova V.D., Tkachev A.V.

N.N. Vorozhtsov Novosibirsk Institute of Organic Chemistry of Siberian Branch of Russian Academy of Sciences  
[dasha.zubricheva@mail.ru](mailto:dasha.zubricheva@mail.ru)

In recent years, quantum chemical calculations have been periodically used in works devoted to the extraction of metals of various groups. Most often, quantum chemistry is used in the extraction of lanthanides and actinides, but there are works in which such calculations optimize or explain extraction processes for alkali metals, 3d-transition metals and noble elements [1-2]. Since quantum chemical calculations help researchers predict the extraction recovery of metals, explain and improve the results obtained, the number of such works will increase in the future.

In this study, it was found that all four studied classes of terpene-containing ligands ( $\alpha$ -aminoximes (I), Aza-Oxa-Based Macrocycles (II),  $D_2$ -Symmetric Macrocycles (III), dipinodiazfluorenes (IV); Scheme 1) are capable of selectively extracting some noble elements (Pd, Au, sometimes Pt and Ru) from a mixture with 3d transition metals, noble and alkaline elements. Moreover, the percentage recovery of palladium and gold in some cases reaches quantitative (>99%) or close to it.

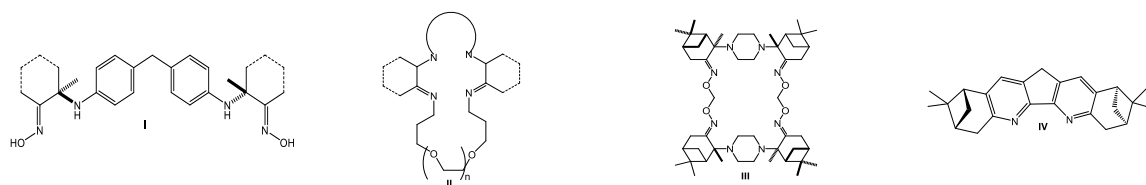

**Scheme 1.** Terpene-containing ligands ( $\alpha$ -aminoximes, Aza-Oxa-Based Macrocycles,  $D_2$ -Symmetric Macrocycles, dipinodiazfluorenes).

All calculations were performed using the ORCA 4\_1\_0 program and Gaussian 09. The authors of this work quantitatively assessed affinity the complexes of  $L \times PdCl_2$  and  $(L \times AuCl_2)^+$  to the organic phase by the difference in the free energy of the complexes in water and chloroform by DFT and HF. In the case of DFT (RKS), we used the PBE0 functional. The authors used various basis sets: def2-SVP, def2-TZVP, def2-TZVPP and def2-QZVPP. Simplifications for calculating the Coulomb and exchange interactions were specified using RIJCOSX and RI-JK. TightSCF and VerytightSCF were used as criteria for iterative convergence of a self-consistent field. There are also two models used for accounting for solvents: CPCM and SMD.

For the  $PdCl_2$  complex with the simplest dipinodiazfluorene and its analogue with one keto group, the authors managed to achieve a flat geometry of the diazafluorene fragment and metalocycle based on the sum of deviations of the moduli of intracyclic torsion angles (HF def2-TZVP def2/JK TightSCF RI-JK Opt).

As molecular studies have shown in the case of macrocycles, the formation of a chelate complex with only one  $PdCl_2$  molecule is possible (unlike  $\alpha$ -amino oximes), and bis-chelation is impossible, since the remaining pair of nitrogen-containing groups has an extremely unfavorable orientation for the additional metalocycle formation.

In the course of calculations of the Gibbs free energy ( $\Delta\Delta G^\circ$ ), it was found that it takes negative values for all complexes of  $L \times PdCl_2$  and positive for the  $L^+$  and  $LH^+ \times PdCl_2$  forms, which explains the extraction of palladium and is consistent with the experimental results. Interestingly, despite the hydrophilicity of the  $(L \times AuCl_2)^+$  complex and the positive  $\Delta\Delta G^\circ$  calculated, extraction of Au was observed experimentally. This fact can be explained by shortcomings in the models CPCM and SMD and also by the inability to correctly take into account all ion pairs for this type of complexes.

## References

- [1] Russ Chem Rev. **2016**, 85(9), 917-942
- [2] Polyhedron **2024**, 250, 116843

## Acknowledgements

The work was supported by the Russian Science Foundation and the Government of the Novosibirsk Region, grant No. 23-23-10043, <https://rscf.ru/project/23-23-10043/>



# **ABSENTEE PARTICIPANTS**

## THEORETICAL APPROACH TO RARE-EARTH AND F-ELEMENTS NITRATE COMPLEXES WITH SIMPLEST AMIDES

*Akulinin Petr V.*<sup>1</sup>, *Savinkina Elena V.*<sup>1</sup>, *Karavaev Igor A.*<sup>1</sup>, *Polukhin Maxim* .<sup>1</sup>

<sup>1</sup>Lomonosov Institute of Fine Chemical Technologies, RTU MIREA

graduate student

[p.akulinin@inbox.ru](mailto:p.akulinin@inbox.ru)

Coordination compounds of rare-earth and other *f*-element nitrates with amides can be used as precursors for various materials, including nanosized oxides, which are widely used in science and industry [1–3]. Therefore, extensive study of these complexes, as well as the study of their structural chemistry is of interest.

DFT methods are the fast and cheap way to theoretically quantum-chemical studying a variety of compounds, including the complexes considered in this work. Among many programs that implement this method, the “PRIRODA” program [4] can be considered as the best.

In this work, on the basis of the geometry of a single crystal, we perform geometric optimization and calculation of normal vibration frequencies for  $[\text{Ln}(\text{AA})_4(\text{NO}_3)_3]$ ,  $[\text{Ln}(\text{AA})_3(\text{H}_2\text{O})(\text{NO}_3)_3]$  and  $[\text{Ln}(\text{AA})_3(\text{NO}_3)_3]$  ( $\text{Ln} = \text{La}—\text{Lu}$ ,  $\text{Y}$ ;  $\text{AA} = \text{CH}_3\text{CONH}_2$ ) by DFT/PBE/L1 and  $[\text{UO}_2\text{L}_2(\text{NO}_3)_2]$  ( $\text{L} = \text{CH}_3\text{CONH}_2$ ,  $\text{C}_2\text{H}_5\text{CONH}_2$ ,  $n\text{-C}_3\text{H}_7\text{CONH}_2$ ,  $\text{C}_6\text{H}_5\text{CONH}_2$ ,  $\text{CH}_3\text{NHCONH}_2$  and  $\text{CH}_3\text{CON}(\text{CH}_3)_2$ ).

Comparison of experimental and calculated geometries as well as IR-spectra confirms the correctness of the used methods. Differences in numerical values provide insight into the nature of intermolecular interactions in the crystals of the complexes. The novel structures of  $[\text{UO}_2\text{L}_2(\text{NO}_3)_2]$  ( $\text{L} = n\text{-C}_3\text{H}_7\text{CONH}_2$ ,  $\text{C}_6\text{H}_5\text{CONH}_2$  and  $\text{CH}_3\text{CON}(\text{CH}_3)_2$ ) correlate with the single-crystal X-ray diffraction study; moreover, the structure of the benzamide complex was first calculated and later confirmed by the experiment. Additionally for  $[\text{UO}_2\text{L}_2(\text{NO}_3)_2]$  ( $\text{L} = \text{CH}_3\text{CONH}_2$ ,  $\text{C}_6\text{H}_5\text{CONH}_2$ ) was provided PES in coordinates of their angles and torsions, which made it possible to evaluate the role of intramolecular bonding on the molecular structure of these compounds.

#### References

- [1] *Russian Journal of Inorganic Chemistry* **2023**, 68, 415
- [2] *Inorganica Chimica Acta* **2022**, 532, 120759
- [3] *Russian Journal of Inorganic Chemistry* **2022**, 67, 1178
- [4] *Russian Chemical Bulletin* **2004**, 54, 820



STRUCTURAL MECHANISMS OF THE  $\text{Li}_x\text{NiO}_2$  LOW-SYMMETRY PHASES FORMATION*Baranova S.A., Lilitsa D.S., Komornikov N. A.*

South-Russian State Polytechnic University, Novocherkassk, Russia

Student

[cof14@mail.ru](mailto:cof14@mail.ru)

Transition metal oxides are considered highly perspective materials for cathodes in various lithium battery applications. Using the methods of group theory, crystallography, crystal chemistry and thermodynamics, phase transformations in one of the most promising cathode materials  $\text{Li}_x\text{NiO}_2$  were studied.

Group-theoretical analysis of phase transitions in  $\text{Li}_x\text{NiO}_2$  not only explains the existence of experimentally discovered modifications but also predicts new phases that may form under different synthesis and operating conditions. This analysis is based on the concept of a "parent phase" with a rock-salt structure, where lithium and cobalt atoms are randomly distributed in the 4a Wyckoff's position, and oxygen occupies the 4b Wyckoff's position. This parent phase gives rise to the diverse experimentally observed low-symmetry phases and phase transitions in  $\text{Li}_x\text{NiO}_2$ .

The analysis shows that the four-dimensional representations  $k_9(\tau_1)$  and  $k_9(\tau_4)$  of the  $Fm\bar{3}m$  group (notations according to Kovalev [1]:  $k_9$  - wave vector star,  $\tau_1, \tau_4$  - numbers of the corresponding irreducible representations for this star) are the critical irreducible representations inducing the variety of phases. Irreducible representations  $k_9(\tau_1)$  and  $k_9(\tau_4)$  are connected by an external automorphism and generate low-symmetry phases with pairwise identical space groups. Among the ten predicted types of low-symmetry modifications, two pairs of rhombohedral modifications with symmetry  $R\bar{3}m$  and one pair of phases with the same space group as the parent phase ( $Fm\bar{3}m$  symmetry) are predicted. This list of possible low-symmetry  $\text{Li}_x\text{NiO}_2$  modifications raises questions about which phases are realized in experimental studies and how they form from the parent phase. To answer these questions, the mechanisms of formation of low-symmetry  $\text{Li}_x\text{NiO}_2$  phases, namely  $Fm\bar{3}m$ ,  $Fd\bar{3}m$ ,  $R\bar{3}m$ , and  $C2/m$ , were investigated.

It is shown that all these phases are formed due to the ordering of lithium and nickel cations, as well as the ordering and displacement of oxygen anions in the initial NaCl-type rock-salt structure. The structures are visualized and their structural features are described.

Possible phase diagrams are constructed theoretically, and it is established that the most stable  $\text{Li}_x\text{NiO}_2$  modifications (spinel-like and rhombohedral) can transform into each other through a first-order phase transition.

### References

[1] O.V. Kovalev, Representations of Crystallographic Space Groups. Irreducible Representations, Induced Representations and Co-representations. London: Taylor and Francis; 1993.

### Acknowledgements

The authors express their gratitude to Professor V.M. Talanov. for setting the problem and consultations.

## CALCULATION OF THE STRUCTURE AND IR SPECTRUM OF MAGNESIUM GLYCINATE BY THE DENSITY FUNCTIONAL METHOD

*Bespalov D.V.<sup>1</sup>, Golovanova O.A.<sup>1</sup>*

<sup>1</sup> Omsk State University Named after F.M. Dostoevsky, Russia  
 Postgraduate  
[d.v.bespalov@rambler.ru](mailto:d.v.bespalov@rambler.ru)

Amino acid metal complexes play an important role in various biological systems and are involved in catalytic chemical reactions. Magnesium glycinate is a biologically active complex that has many useful properties and is widely used in medicine, pharmacology and sports nutrition. Magnesium plays a key role in the formation of artificial synapses between nerve cells, which improves the transmission of nerve impulses and helps maintain normal nervous system function. Due to its low stability, this compound is poorly understood [1].

The structure and IR spectra were calculated with the standard quantum chemical modelling software package GAMESS (USA) using the DFT (B3LYP) method in the 6-31G basis [2]. The 6-31G basis includes one basis function for the inner shell, grouped from six Gaussian functions, and a set of an inner function grouped from three Gaussian functions and an outer ungrouped Gaussian function for the valence shell of each atom. The 6-31G basis was chosen for the model construction because of the balance of accuracy and calculation time. The structural and dynamic model of magnesium glycinate was constructed, the energy of the magnesium glycine model was minimised, the structure, and the frequencies of normal oscillations in the harmonic approximation were calculated.

The synthesis of magnesium glycinate was carried out at a molar ratio of metal to amino acid of 1:1. The methodology for the synthesis of similar compounds from article [3] was taken as a basis. A suspension of Gly (0.1125 g) was dissolved in 2 mL of distilled water (pH~5.46). Then a suspension of MgCl<sub>2</sub>\*6H<sub>2</sub>O (0.3048 g) was added. The solution was left in a dark place, and with the passage of time the chemical reaction of the amino acid with Mg<sup>2+</sup> ion takes place and the obtained compound crystallises. After 7 days, a crystalline precipitate was obtained. The precipitate was filtered and washed with a small amount of water, dried to remove excess moisture.

The method of IR spectroscopy was used to determine the group composition of the synthesised compound. The IR spectrum was obtained on a spectrophotometer FMS 2202. The spectra were recorded with a resolution of 1 cm<sup>-1</sup>. The spectrum of the investigated sample was recorded in the range of 500 to 4000 cm<sup>-1</sup>. The experimental IR spectra were compared with the calculated ones and conclusions were drawn about the adequacy of the obtained data and consequently about the structure of the synthesised compound.

X-ray phase analysis was performed to calculate the parameters of the unit cell on an X-ray diffractometer DRON-3M using the Debye-Scherrer method. Diffractograms were taken in the angle range 2-4°-80°. The measurement was carried out in increments of 0.050°. Step execution time: 576 s. Anode: Copper (1.541874Å). Generator voltage: 40 kV.. Data processing was carried out using the following programs: OriginPro 2021, QualX2.0, Excel. The XRD spectra Crystallography Open Database (POW\_COD) was used. The unit cell parameters were calculated using the FullProf Suite software package using the dichotomy method [4].

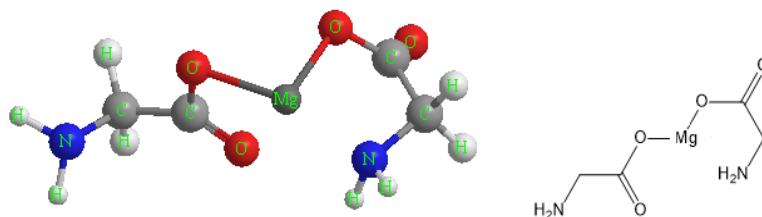

**Scheme 1.** Magnesium Glycinate: 3D model and structural formula.

### References

- [1] Russian Chemical Journal. **2020**. 64, 2.  
 [2] *Advances in Physical Sciences*. **2002**, 172, 3.  
 [3] *Butlerov Communications*. **2021**, 65, 1  
 [4] *Journal of Applied Crystallography*. **2004**, 37.

### Acknowledgements

The research was carried out within the state assignment of ministry of science and higher education of the Russian federation, theme No. 075-03-2023-149.

STRUCTURAL MECHANISMS AND THERMODYNAMICS OF PHASE TRANSITIONS IN LiCoO<sub>2</sub>*Lilitsa D.S., Baranova S.A., Komornikov N. A.*

South-Russian State Polytechnic University, Novocherkassk, Russia

Student

[lilitsad@mail.ru](mailto:lilitsad@mail.ru)

Compound LiCoO<sub>2</sub>, a prominent cathode material in lithium batteries, exhibits several structural transformations that have defied a unified interpretation despite extensive research. Three modifications of LiCoO<sub>2</sub> are reported in the literature: a low-temperature form with a spinel-like structure (space group  $Fd\bar{3}m$ ) formed at 400°C, a high-temperature form with a layered  $\alpha$ -NaFeO<sub>2</sub>-type structure (space group  $R\bar{3}m$ ) formed at 800°C, and an unstable phase with a rock-salt structure. The composition and structure of LiCoO<sub>2</sub> phases vary depending on the synthesis technology, temperature, and electrochemical operating conditions.

This study examines the structures of all LiCoO<sub>2</sub> phases as a result of atomic ordering in a parent phase with a rock-salt structure (space group Fm3m), where lithium and cobalt atoms are randomly distributed in the 4a Wyckoff's position and oxygen occupies the 4b Wyckoff's position. Symmetry analysis of existing experimental data identified the possible critical irreducible representations inducing all phase transitions as representations  $\mathbf{k}_9(\tau_1)$  and  $\mathbf{k}_9(\tau_4)$  of the Fm3m group (notations according to Kovalev: the first number indicates the wave vector star  $\mathbf{k}$ , the second - the number of the corresponding irreducible representation within this vector). Irreducible representations  $\mathbf{k}_9(\tau_1)$  and  $\mathbf{k}_9(\tau_4)$  are connected by an external automorphism and generate 10 pairs of low-symmetry phases with pairwise identical space groups.

This work constructs a phase diagram based on the theory of second-order phase transitions, models the structural mechanisms of low-symmetry phase formation, and calculates the structures of possible LiCoO<sub>2</sub> modifications. This comprehensive theoretical analysis provides a unified framework for understanding the complex structural transformations in LiCoO<sub>2</sub>, offering valuable insights for optimizing its performance in lithium batteries.

**References**

[1] O.V. Kovalev, Representations of Crystallographic Space Groups. Irreducible Representations, Induced Representations and Co-representations. London: Taylor and Francis; 1993.

**Acknowledgements**

The authors express their gratitude to Professor V.M. Talanov. for setting the problem and consultations.

ON A ZONE STRUCTURE OF ENERGY STATES OF LARGE POLYATOMIC SYSTEMS AND  
THE FEATURES OF CHEMICAL REACTIONS

*Novosadov B.K.*

V. I. Vernadsky Institute of Geochemistry and Analytical Chemistry RAS  
(Russian Federation, Moscow)

This article is devoted to clarifying the general regularity of the theory of the spectra of large polyatomic molecules, which follows from the multiple degeneracy of atomic levels. In the molecules of any chemical substance, there are groups of atoms of the same type that enter the functional groups of atoms in the molecule.

The spectra of molecules are complex sequences of levels, the theory of which is formulated as solutions to the Schrodinger wave equation, taking into account additional conditions on the form of solutions and the behavior of solutions with an infinite radius of particles from the center of mass of the molecule. Usually, the spectral patterns of molecular spectra are derived based on models of the structure of the electronic shells of atoms and their modification when the latter are combined into a molecule.

The main method for calculating the spectrum of electronic states is the MO LCAO method, which implements the idea of representing the electronic state of a molecule in the form of combining atomic orbitals of free atoms with corrections of orbital parameters for the mutual influence of electron charges and atomic nuclei. The distances between different atoms of a molecule are enclosed in the range from the value of the length of chemical bonds for neighboring atoms to the sum of the bond lengths of atoms distant from each other. The result is a very complex structure of the electronic spectrum of the molecule, which is loaded with the oscillation levels of the nuclei.

At the same time, the presence of identical atoms in a molecule, say, ligand atoms in inorganic compounds, cluster atoms in metals, carbon and hydrogen atoms in organic compounds, etc. leads to a kind of degeneration of the initial atomic states, which, when atoms are combined into a molecule, are transformed into molecular terms of a multi-electronic polyatomic system.

This identity of the spectra of atoms of the same kind should lead to a certain structure of the electronic spectra of large molecules, which is discussed in this article. The presence of spectral features of such molecules correlates with the physical consequences of the behavior of molecular systems when interacting with each other and with external electromagnetic fields.

CALCULATION OF KINETIC CHARACTERISTICS OF THE  $\gamma$ -Al<sub>2</sub>O<sub>3</sub> FLUORINATION PROCESS BY FITTING NONLINEAR REGRESSION MODELS

*Puzhel A.O.<sup>1</sup>, Borisov V.A.<sup>2</sup>,*

<sup>1</sup> Dostoevsky Omsk State University, Omsk, Russia

<sup>2</sup> Omsk State Technical University», Omsk, Russia

[PuzhelAO@omsu.ru](mailto:PuzhelAO@omsu.ru)

There is considerable interest in the processing of industrial waste to extract valuable components. Spent cracking catalyst is a potential secondary source of rare earth elements. For the processing of aluminosilicate materials, which include zeolite-containing cracking catalysts, thermal treatment with ammonium fluoride (hydrofluoride) is the most promising. The process of hydrofluorination of cracking catalysts is complex and includes both parallel and sequential stages. To understand the processes occurring as a result of hydrofluorination of the catalyst, the stages of interaction need to be examined using model samples that are constituents of the catalyst. The process of hydrofluorination of silicon oxide was studied by the authors in work [1]. In this study, a similar approach was applied to the process of hydrofluorination of aluminum oxide.

To obtain kinetic data for the hydrofluorination process, kinetic analysis was applied using the method of nonlinear model fitting [2]. Thermogravimetric (TGA) curves of the hydrofluorination of  $\gamma$ -Al<sub>2</sub>O<sub>3</sub> were obtained at different heating rates of the mixture: 1, 2, 5, and 10 °C/min (Figure 1-a).

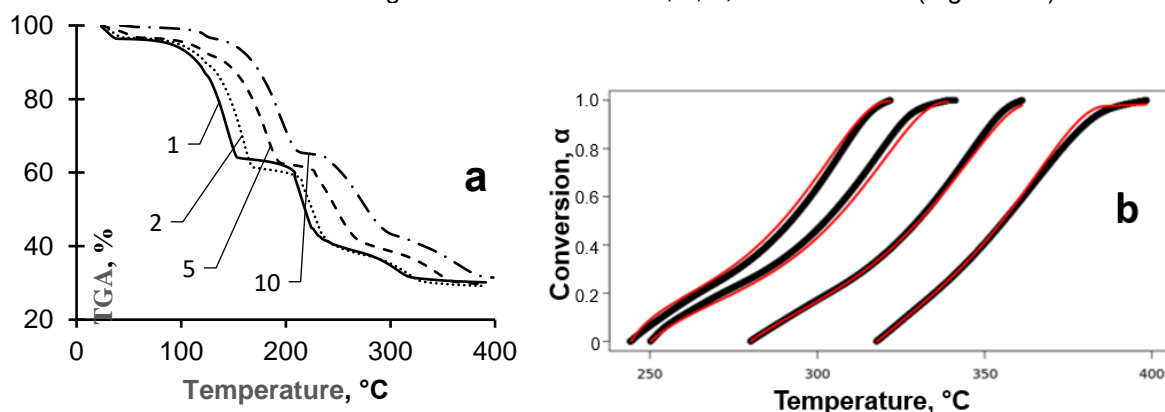

**Figure 1.** a - TGA curves of mixtures of aluminum oxide with NH<sub>4</sub>F at heating rates; b - graphical dependencies of conversion on temperature obtained by the method of fitting nonlinear regression models

TGA curves were divided into temperature intervals and converted into integral kinetic plots, to which the model fitting method was applied (Figure 1-b). By comparing the calculated curves (red lines) with the experimental curves (black lines), the values of the kinetic triplet were calculated: activation energy, reaction rate constant, and kinetic equation for the sequential stages:

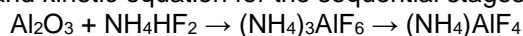

The Flexible single step (ePT) equation (ePT) [3] was used for model fitting. The thermokinetic open-source software "THINK" was used for data processing. The kinetic triplet for the reaction forming (NH<sub>4</sub>)<sub>3</sub>AlF<sub>6</sub> has the following values:  $E_a$  - 84.1±0.44 kJ/mol,  $\ln(k)$  - 14.6±0.11 s<sup>-1</sup>,  $f(\alpha) = (1-\alpha)^{1.31}\alpha^{0.69}$ ; for the reaction forming (NH<sub>4</sub>)AlF<sub>4</sub>:  $E_a$  - 107.3±0.4 kJ/mol,  $\ln(k)$  - 15.3±0.01 s<sup>-1</sup>,  $f(\alpha) = (1-\alpha)^{0.55}\alpha^{0.16}$ . Similarly, a parallel stage of ammonium fluoride decomposition to ammonium hydrofluoride was identified ( $E_a$  - 84.1±0.44 kJ/mol).

#### References

- [1] Chemical Engineering Research and Design. **2022**, 182, 490
- [2] *Thermochimica Acta*. **2023**, 719, 179384
- [3] Energy Fuels. **2015**, 29 (5), 2906

## CORRELATION OF THE EXPERIMENTAL DATA ON LIQUID-LIQUID EQUILIBRIUM IN ALCOHOL – ESTER – DES SYSTEMS USING NRTL EQUATION

Smirnov A.A., Toikka M.A.

St. Petersburg State University, St. Petersburg, Russia

PhD student

[a.a.smirnov97@yandex.ru](mailto:a.a.smirnov97@yandex.ru)

Deep eutectic solvents (DES) are the most promising alternatives to volatile organic solvents and ionic liquids in the chemical production processes. Their low volatility, biodegradability and non-toxicity make them environmentally friendly solvents [1]. There are plenty of works, where DES are used as an extractant for the separation of the systems which difficult to separate by other methods, for example, alcohol – ester systems [2-3]. To evaluate the effectiveness of this separation, a study of liquid-liquid equilibrium (LLE) in alcohol – ester – DES systems is carried out.

The non-random two-liquid (NRTL) equation is the most proven and popular model for describing the thermodynamic properties of heterogeneous solutions. This equation was used to correlate experimental data on liquid-liquid equilibrium [4]. The NRTL model is based on Wilson's theory of local compositions [5]. The model is based on the calculation of the activity coefficients  $\gamma_i$  of component  $i$  in phase  $x_i$  by the following equation:

$$\ln \gamma_i = \frac{\sum_{j=1}^N x_j \tau_{ji} G_{ji}}{\sum_{k=1}^N x_k G_{ki}} + \sum_{j=1}^N \frac{x_j G_{ij}}{\sum_{k=1}^N x_k G_{kj}} \left( \tau_{ij} - \frac{\sum_{l=1}^N x_l \tau_{lj} G_{lj}}{\sum_{k=1}^N x_k G_{kj}} \right), \quad (1)$$

$$\tau_{ij} = \frac{g_{ij} - g_{jj}}{RT}, \quad (2)$$

$$G_{ij} = \exp(-\alpha \tau_{ij}), \quad (3)$$

where  $x$  is the mole fraction of the component in the system  $g_{ij}$  is the energy parameter, which characterizes the interaction between the components  $j$  and  $i$ ,  $\alpha$  is the “non-randomness” parameter of the system, associated with the degree of order of the distribution of molecules in a solution.

Parameters  $\Delta g_{ji}$  were calculated using the selection method by minimizing the objective function (OF):

$$OF = \sum_{i=1}^n \sum_{j=1}^m (a_{ij}^{org, exp} - a_{ij}^{DES, exp})^2, \quad (4)$$

where  $a_{ij}^{org, exp}$  – the calculated component  $i$  activity in the organic phase of the experimental tie-line  $j$ .  $a_{ij}^{DES, exp}$  – the calculated component  $i$  in the DES-rich phase of the experimental tie-line  $j$ .

For the investigation several alcohol – ester systems were chosen (ethanol – ethyl formate, 1-propanol – 1-propyl formate, 1-butanol – 1-butyl formate). As DES four solvents based on choline chloride with different hydrogen bond donors (urea, glycerol, glutaric acid, ethylene glycol) were chosen. Calculations of LLE for all pseudo-ternary alcohol – ester – DES systems were carried out. Comparison of calculated and experimental data demonstrated pretty well consistency. Standard deviation  $\sigma$  did not exceed 1.27 %.

### References

- [1] *Chemosphere* **2016**, 147, 460-466
- [2] *Ind. Eng. Chem. Res.* **2023**, 62 (1), 586–597
- [3] *J. Chem. Eng. Data* **2024**, 69 (4), 1699–1708
- [4] *Ind. Eng. Chem. Process Des. Dev.* **1969**, 8, 413–419
- [5] *J. Am. Chem. Soc.* **1964**, 86 (2), 127–130

### Acknowledgements

This work was supported by the Russian Science Foundation (grant 20-73-10007, <https://rscf.ru/en/project/20-73-10007/>).

## STRUCTURAL ANOMALY IN LIQUID ANTIMONY: DFT ANALYSIS

*Tsygankov A.A.*<sup>1,2</sup>, *Galimzyanov B.N.*<sup>1,2</sup>, *Mokshin A.V.*<sup>1,2</sup>

<sup>1</sup> Kazan Federal University, Kazan, Russia

<sup>2</sup> Udmurt Federal Research Center of the Ural Branch of the RAS, Izhevsk, Russia

Postgraduate Student

[tsigankov.artiom@yandex.ru](mailto:tsigankov.artiom@yandex.ru)

Liquids are often characterized by the presence of a homogeneous distribution of atoms at large distances and short-range order at small distances. However, liquid antimony is an unusual system due to its structure, which exhibits anomalies in the form of shoulders in the radial distribution function and static structure factor [1, 2]. The reason for the existence of this anomaly is not yet fully understood [3, 4]. The radial distribution function is a characteristic of the probability of finding a particle at a certain distance from another particle. Therefore, we can conclude that this feature can only occur if atoms form at least quasi-stable structures [4]. To reproduce the structural features of liquid antimony, ab-initio molecular dynamics simulations were performed in the VASP package [5] using density functional theory (DFT) methods at temperature  $T = 923$  K and pressure  $P = 1.0$  atm.

To determine the possibility of the existence of stable structures in liquid antimony, the distribution of particles by neighbourhood times was calculated from the obtained results of ab-initio molecular dynamics simulations. In the framework of the Williams-Landel-Ferry model, it was shown that in the regions bounded by a sphere of radius 5 Å there are stable formations with a lifetime greater than 1.6 ps [6]. In order to identify such structures, the order parameters  $q_4$  and  $q_6$  were estimated and the structures were characterized. The results demonstrated the formation of triangular structures with lengths  $a = 3.07$  Å,  $b = 4.7$  Å and angles  $\alpha = 45^\circ$  and  $\beta = 90^\circ$  in liquid antimony (Figure 1). Furthermore, the quasi-stable formations were observed to exert a direct influence on the presence of a shoulder in the radial distribution function and the static structure factor.

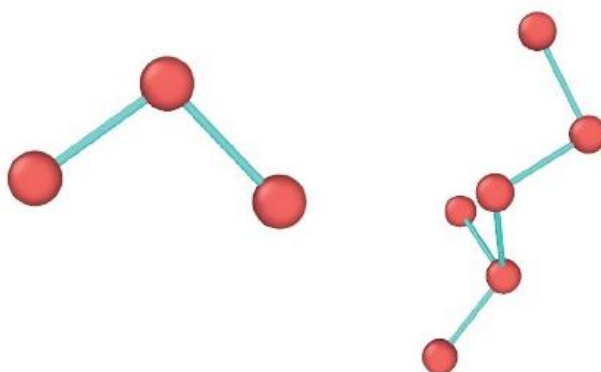

**Figure 1.** Example of triangular structure and chain formed by antimony atoms.

#### References

- [1] *Physica Status Solidi (b)* **1972**, 49 (339), 339
- [2] *The Journal of Chemical Physics* **2010**, 133 (9), 094506
- [3] *Chemical Science*, **2024**, 15, 3382
- [4] *The Journal of Chemical Physics* **2017**, 146 (19), 194502
- [5] *The Physical Review B* **1993**, 47 (1), 558
- [6] *Journal of the American Chemical Society* **1955**, 77 (14), 3701

#### Acknowledgements

This paper has been supported by the Kazan Federal University Strategic Academic Leadership Program ("PRIORITY-2030").

## MAGNETICALLY INDUCED RING-CURRENTS IN ODD-NUMBER CYCLO[N]CARBONS

*Valiulina L.I.*

Tomsk State University, Tomsk, Russia

PhD student

[valiulina-lenara@mail.ru](mailto:valiulina-lenara@mail.ru)

Cyclocarbons represent a new form of carbon molecules that are formed by combining sp-hybridized carbon atoms into a ring. The first synthesis of cyclo[18]carbon aroused interest in studying the properties and structure of molecular ring with different numbers of carbon atoms, including those with an odd-number of atoms [1, 2].

The aim of this study was to investigate the structure and electron delocalization of a series of cyclo[n]carbons with an odd-number of carbon atoms ( $n=11-29$ ). The optimized molecular structures of the studied cyclo[n]carbons were obtained at the ab initio complete active space self-consistent field (CASSCF) level. The 6-31G(d,p) basis set was used in the optimization of the molecular structures. The (14,12) active space (14 electrons in 12 active orbitals) were used for all of the studied molecules in CASSCF calculations. Magnetically induced ring-currents were calculated to investigate the electron delocalization and aromaticity of cyclo[n]carbons. Calculations of magnetically induced current densities were carried out using the gauge-including magnetically induced currents (GIMIC) method at the BHandHLYP/6-31G(d,p) level of theory.

Calculations show that odd-number cyclo[n]carbons have a singlet ground state. The lone pair of electrons of the carbene atom is located in the plane of the molecular ring. The structures are characterized by two conjugated systems:  $\pi_{in}$  and  $\pi_{out}$ , each of which involves an even number of electrons. The global aromaticity is determined by electrons from  $\pi_{out}$ -conjugated system resulting in an alternating aromaticity of odd-number cyclo[n]carbons. Molecular rings with  $n=4k+1$  are antiaromatic and sustain a net paratropic ring-current, whereas structures  $n=4k+3$  are aromatic with a net diatropic ring-current (Figure 1). The ring-current strength decreases for large rings. For large  $k$  ( $k \geq 6$ ) values, the studied cyclo[n]carbons are nonaromatic.

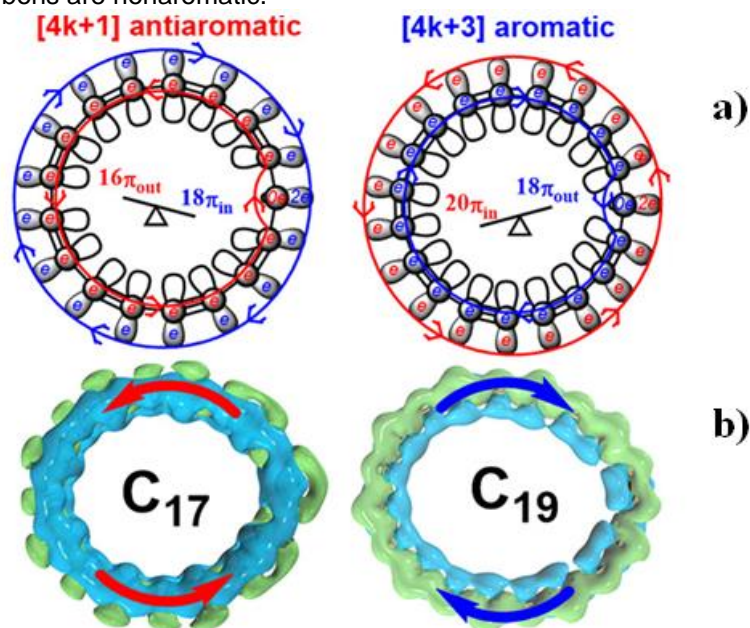

**Figure 1.** a) Mixed aromatic and antiaromatic character of C<sub>17</sub> and C<sub>19</sub>; b) Magnetically induced current density: the green and blue isosurfaces denote the diatropic and paratropic current densities, respectively.

## References

- [1] *Science* **2019**, 365, 1299.  
 [2] *J Phys Chem A* **2022**, 126, 2445



## CORRELATION OF INTERMOLECULAR INTERACTIONS WITH SOLUBILITY OF SUCCINYLSULFATHIAZOLE POLYMORPHS

Yadrincev A.V.<sup>1</sup>, Savchenkov A.V.<sup>1</sup><sup>1</sup> Samara National Research University, Faculty of Chemistry, Samara, Russia

Graduate student

[artyadik@mail.ru](mailto:artyadik@mail.ru)

Currently, one of the actively researched phenomena in medicine is the polymorphism of drugs, which determines their properties and pharmacotherapeutic effectiveness. The solubility of different polymorphic modifications may differ significantly, which may lead to a difference in the kinetics of their dissolution *in vivo* and, as a result, different bioavailability of drugs. In this paper, a theoretical method for evaluating the solubility of polymorphic modifications is proposed using the example of the polymorphism of the antibiotic succinylsulfathiazole (Scheme 1).

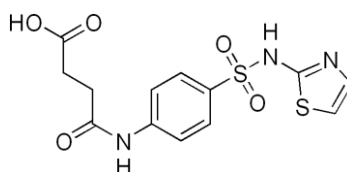

**Scheme 1.** Chemical structure of succinylsulfathiazole.

The paper considers the method of molecular Voronoi-Dirichlet polyhedra to identify the dependencies between the volumes  $V_m$  corresponding to intermolecular (noncovalent) contacts in crystals of polymorphic modifications of succinylsulfathiazole and the solubility  $S$  relative to the solubility of polymorph I ( $S_I$ ).

The calculation of the volume  $V_m$  and the number of contacts  $N$  of noncovalent interactions was carried out using the TOPOS (InterMol) program. The experimental values of the relative solubility  $S/S_I$  of polymorphic modifications (III), (IV) and (V) are 1.9, 2.9, 3.9, respectively [2]. A linear dependence was obtained of the ratio  $S/S_I$  on the number of intermolecular contacts to the volume of intermolecular interactions with the quadratic deviation  $R^2 = 0.9702$  (Scheme 2).

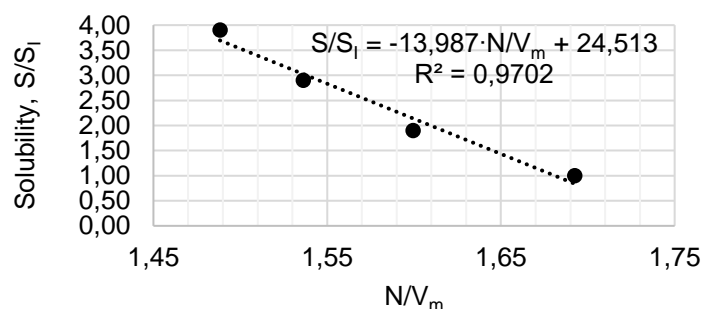

**Scheme 2.** The dependence of the relative solubility  $S/S_I$  on the ratio  $N/V_m$ .

Based on the obtained dependence, previously unknown solubilities of polymorphic modification (VI) and succinylsulfathiazole solvates with acetone, dioxane and tetrahydrofuran were calculated relative to the solubility of polymorphic modification (I), which amounted to 3.1, 2.8, 3.0 and 3.5, respectively [3].

### References

- [1] *Experimental Gerontology*, **2021**, 150, 111387  
 [2] *Solid-state chemistry of drugs*, **1999**, 2, 143  
 [3] *CrystEngComm*, **2014**, 16, 4706

### Acknowledgements

This work was supported by the Russian Science Foundation (project No 20-73-10250).

## QUANTUM CHEMICAL INVESTIGATION OF POLYTWISTANE-LIKE NANOSTRUCTURES

*Zolenko M.A.*<sup>1</sup>, *Porsev V.V.*<sup>1</sup>

<sup>1</sup> St. Petersburg State University, St. Petersburg, Russia  
 Student  
[st087380@student.spbu.ru](mailto:st087380@student.spbu.ru)

The extremal compression of solid benzene and pyridine was shown to yield polymerization products which consisted of one-dimensional carbon and carbon nitride nanothreads [1, 2]. These substances exhibited interesting properties, so the experimental and theoretical studying of them would be fruitful for the development of new materials.

The polytwistane structure was revealed to be the most stable of the structures proposed for sp<sup>3</sup> carbon nanothreads. A quantum chemical study of polytwistane showed that its symmetry should be described by line groups [3].

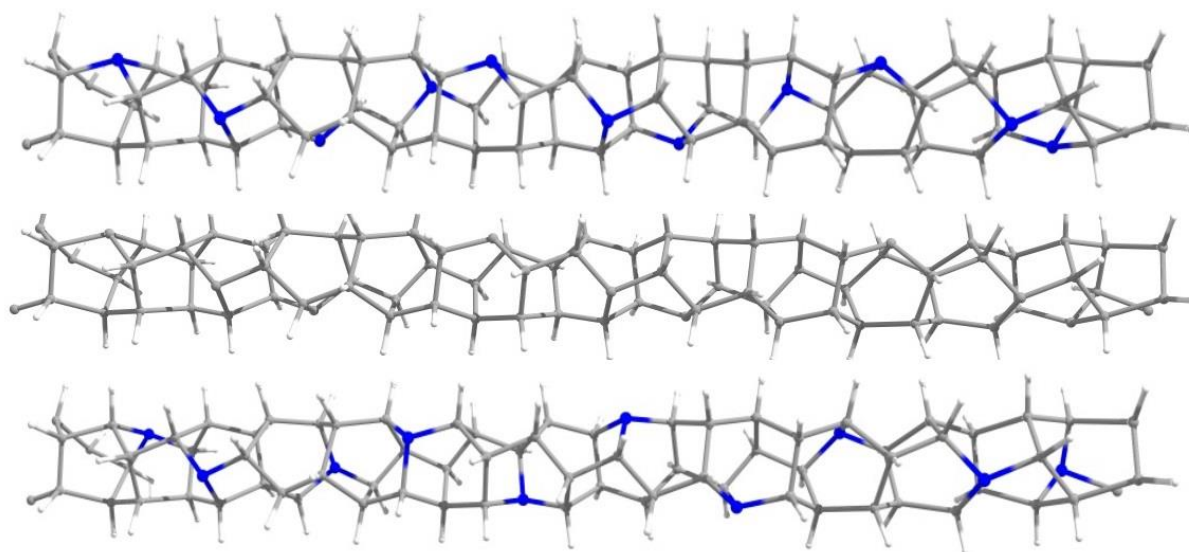

**Scheme 1.** Polytwistane structure (in the middle) and two possible options of nitrogen substitution. (white, grey and blue balls denote hydrogen, carbon and nitrogen atoms correspondingly)

We quantum-chemically investigated the electronic and mechanical properties of nitrogen-substituted polytwistane analogs using the approach based on the line symmetry groups [4]. The CRYSTAL17 program [5] was used for calculations.

#### References

- [1] Fitzgibbons, T.C. et al. *Nature Mater* **2015**, *14*, 43-47
- [2] Li, X. et al. *J. Am. Chem. Soc.* **2018**, *140*, 4969-4972
- [3] Domnin, A.V. et al. *Com. Mat. Sci.* **2022**, *214* 111704
- [4] Porsev, V.V. et al. *Com. Mat. Sci.* **2022**, *203*, 111063.
- [5] Dovesi, R. et al. *WIREs Comput. Mol. Sci.* **2018**, *8*, e1360.



# **ECONOMICS OF THE CHEMICAL INDUSTRY IN THE CONTEXT OF MODERN CHALLENGES**



# **KEYNOTE & INVITED SPEAKERS**



## KEYNOTE SPEAKER



**Dr. Evgeniya Zhalskaya**

*Head of the Analytics Department, Solopharm, Russia*

**Organization of the Process of Import Substitution in  
the Pharmaceutical Market of Russia**

ORGANIZATION OF THE PROCESS OF IMPORT SUBSTITUTION IN THE PHARMACEUTICAL  
MARKET OF RUSSIA

*Zhalskaya E.V.*

Solopharm, Russia  
PhD, Head of the Solopharm Analytics Department  
[evgeniya.zhalskaya@grotexmed.com](mailto:evgeniya.zhalskaya@grotexmed.com)

The development of the range of medicines in the pharmaceutical market over the past few years has been mainly due to domestic companies.

This trend is a consequence of both import substitution processes and the localization activity of foreign companies that expand the range of products manufactured in RF.

The import substitution process of Russian pharmaceutical market has been going on for more than 10 years and affects all steps of R&D and production.

The government-approved plan for the implementation of the «Pharma 2030 Pharmaceutical Industry Development Strategy» is aimed at providing the population with the necessary high-quality medicines and focuses on creating full-cycle production, including pharmaceutical substations in the territory of the Russian Federation.



# **ORAL & POSTER PRESENTATIONS**

# TECHNOLOGY FOR EXTRACTING LITHIUM IONS FROM BRINES USING POLYMER MEMBRANES

*Dmitrieva M.A.<sup>1</sup>, Doroshenko I.V.<sup>1</sup>, Filippova I.S.<sup>1</sup>, Moshkov A.I.<sup>1</sup>*

<sup>1</sup> ITMO University, St. Petersburg, Russia

PhD student

[m\\_dmitrieva@scamt-itmo.ru](mailto:m_dmitrieva@scamt-itmo.ru)

A promising approach to lithium extraction is its recovery from associated waters (brines) of oil and gas condensate fields. The lithium production market is constantly growing, and according to preliminary expert estimates, it may grow by an average of 20% annually over the next decade. One of the promising approaches to lithium extraction is its recovery from associated waters of oil and gas condensate fields, the so-called brines [1].

The work proposes a method for lithium extraction using a two-layer polymer membrane made of cellulose acetate, modified with 4'-aminobenzo-15-crown-5 ether (4'AB15C5) and a metal-organic framework (ZIF-8). These compounds have selective properties towards lithium ions due to the size of the crown ether ring and "windows" in the ZIF-8 structure.

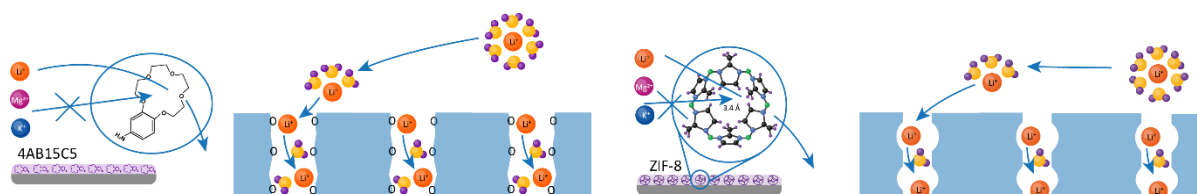

**Figure 1.** Passage of lithium ions through polymer membranes modified 4AB15C5 and ZIF-8.

The project aims to extract lithium from associated waters of oil and gas condensate fields using membrane technology (Direct lithium extraction or DLE). Traditional methods using adsorbents have several disadvantages, such as the need for large volumes of solutions for lithium desorption, leading to additional costs and negative environmental impact. The use of selective membranes allows avoiding these problems and reducing the overall duration of the process.

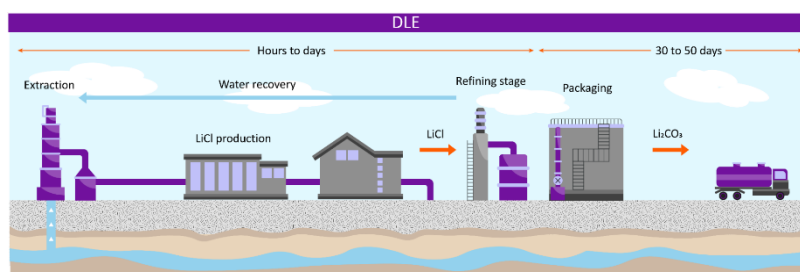

**Figure 2.** DLE lithium mining scheme.

In this work, we modeled the process of lithium extraction using membrane extraction, for which formation waters obtained from deposits in Eastern Siberia were initially purified and studied.

The membrane module will be integrated into the hydrocarbon production process, providing oil companies with the opportunity to generate additional revenue from the processing of associated waters. This is particularly relevant, considering the significant lithium reserves in water sources in Russia, estimated at around \$70 billion.

## References

- [1] Energy Agency I. *The Role of Critical World Energy Outlook Special Report Minerals in Clean Energy Transitions.*
- [2] Kalmykov D. et al. *Operation of three-stage process of lithium recovery from geothermal brine: simulation //Membranes. – 2021. – V. 11. – №. 3. – p. 175.*

## Acknowledgements

This work was supported by The Priority 2030 Federal Academic Leadership Program.



# STRATEGIES OF PERSONNEL MANAGEMENT IN THE CHEMICAL INDUSTRY IN THE CONTEXT OF MODERN CHALLENGES

*Dolgoplova A.R., Koriakova P.N.*

St. Petersburg State University, St. Petersburg, Russia  
Department of Economics  
Student of Bachelor's degree  
[st118447@student.spbu.ru](mailto:st118447@student.spbu.ru)

Chemical industries confront challenges, principally entailing the provision of import-supplanting commodities for the internal market. Nonetheless, to fully capitalise upon the emerging opportunities, the indigenous chemical sector necessitates an influx of highly proficient individuals. In connection with the expansion of the chemical industry in Russia, the role of management in this area is increasing. Therefore, there is an urgent need to form an innovative team of employees, to quickly allocate resources, or, in a word, these employees must be a change manager. The problem is that chemical enterprises are an industry that requires different resources and technologies, but the use of traditional personnel management in the mechanism of personnel quality management is still carried out, the scientific and rational mechanism of personnel quality management is often not studied and applied. According to enterprise monitoring conducted by the Central Bank, the chemical industry has experienced the lowest level of personnel in the last 25 years since the beginning of 2023 [1].

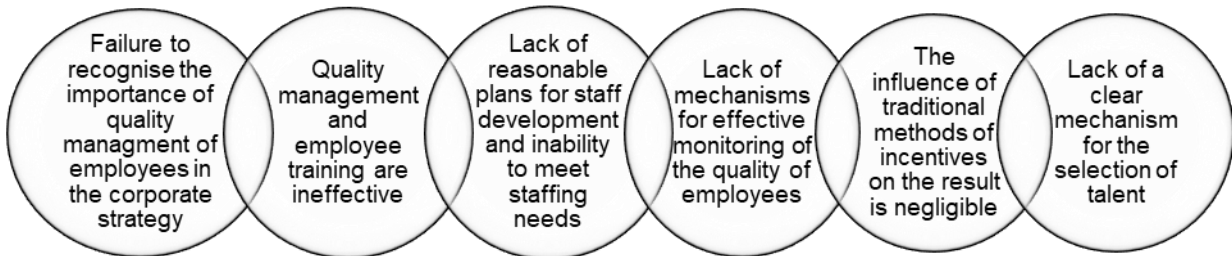

**Scheme 1.** Factors causing problems in the mechanism of personnel management in the chemical industry.

The goal of this work is to find and describe strategies that will help optimize new approaches to improve the quality of personnel through the production process. Based on existing programs in Russia, such as the federal project "Advanced Engineering Schools" (2022) or the Titan Group project "Orbit Titan" (2024), several personnel management strategies can be identified [2-3].

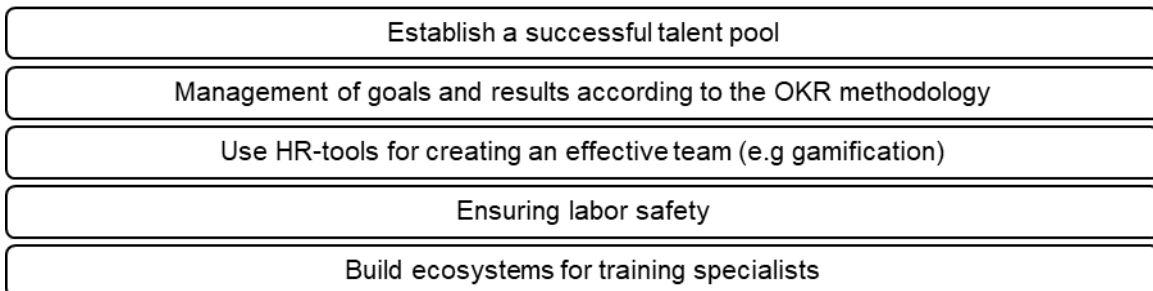

**Scheme 2.** Strategies of personnel management.

## References

- [1] Monitoring of industrial enterprises // Central bank of Russia: official website, 2024 – URL: <https://cbr.ru/>
- [2] Federal project "Advanced engineering schools" // Advanced engineering schools: official website, 2022-2024 – URL: <https://engineers2030.ru/>
- [3] Titan Group project "Orbit Titan" // Titan Group: official website, 2024 – URL: <https://titan-group.ru/en/>

# THE RUSSIAN PHARMACEUTICAL MARKET: IMPORT SUBSTITUTION AND BREAKTHROUGH POSITIONING STRATEGY

*Gorbunov P.E<sup>1</sup>, Koshkin A.V<sup>1</sup> Pashkus V.Y.<sup>2</sup>*

<sup>1</sup> St. Petersburg State University, St. Petersburg, Russia  
Student

[pgorbunov276@gmail.com](mailto:pgorbunov276@gmail.com)

<sup>2</sup> St. Petersburg State University, St. Petersburg, Russia

Today, Russia is under unprecedented sanctions pressure from the "collective West." It should be noted that despite the loud statements of politicians, sanctions have affected almost all spheres of public production (except, perhaps, the "peaceful atom") and sanctions pressure is constantly increasing (moreover, even to the detriment of those countries that impose these sanctions). However, there are areas where the imposition of certain sanctions can seriously undermine the security of society – this is pharmaceuticals.

In these conditions, great importance is attached to the protectionist import substitution policy and its variations – import conservation and export-oriented import substitution. Indeed, the sanctions policy quickly led to a ban on the supply of a number of medicines to the Russian market. There was a need to implement an import substitution policy, which became possible only thanks to the successes of the chemical industry, which created the basis for the implementation of this policy in the pharmaceutical industry.

An analysis of the specifics of the pharmaceutical market in Russia shows that this market has some features that complicate the use of strategic management tools in it. According to the conducted research, there is a weak use of modern marketing tools, which is due both to the specifics of the market and to the insufficient level of marketing knowledge among the heads of pharmaceutical enterprises. This leads to the choice of inadequate strategic decisions and insufficiently effective positioning of Russian drugs, and, as a result, their insufficient evaluation. The solution to this problem may be related to the use of such a modern strategic marketing tool as breakthrough positioning.

The breakthrough positioning strategy was proposed by J. Cagan and C. Vogel. This tool allows us to identify promising areas of positioning for Russian pharmaceuticals and develop a successful market entry strategy for them.

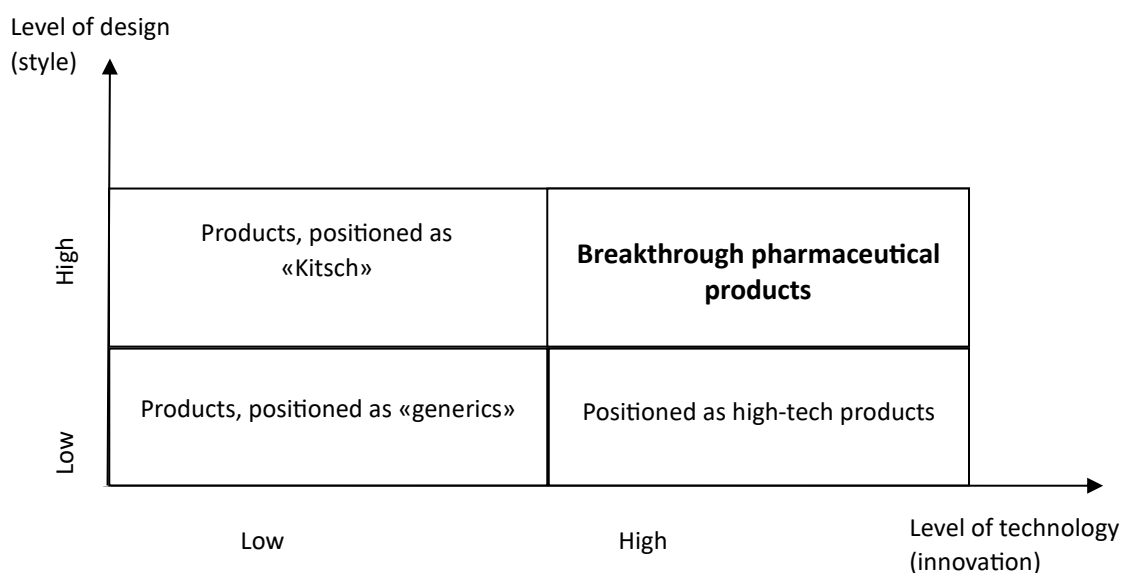

**Рисунок 1.** Modified map positioning of Cagan and Vogel

## TALENT MANAGEMENT IN THE CHEMICAL INDUSTRY

*Koriakova P.N, Dolgopolova A.R.*

St. Petersburg State University, St. Petersburg, Russia

Department of Economics

Student of Bachelor's degree

[o\\_koryakova@mail.ru](mailto:o_koryakova@mail.ru)

The goal of this work is to identify the policies being implemented by HR managers in the chemical industry enterprises under sanctions. The object of the research is a labour-market of the chemical industry. The subject of the research is certain measures which will be taken by HR-managers so as to search and nurture the most valuable and skilled personnel in organisations.

In order to uncover the talent acquisition policy, lists of the chemical companies that left Russian chemical industry in 2022, as well as Russian companies with their total revenue of 2022, were analysed, which were represented by raex-rr.com. The main consequences, which had essential impact on the Russian chemical industry, along with a list of vacancies, which are now highly demanded among chemical enterprises, were also reviewed.

Despite the ongoing imposition of sanctions against Russia, the chemical industry continues to develop and maintain one of the highest positions in the world, proceeding to export downstream operations, towards which Russian chemical industry orients. The share of its export amounted to 70.8%. In 2022 the Russian chemical industry increased by 12.9% compared to 2021, expressed in monetary terms. In section for chemical substances growth rates were 13.4%, for rubber and plastic products it amounted to 11.3%. The Russian chemical industry leaders such as "MCC EuroChem", "SIBUR Holding" and "UralChem" have posted lists of most popular vacancies. In this list a tendency in the increasing demand for technologists, engineers of various profiles, HR managers and procurement managers can be seen.

Due to the necessity in recruiting the best specialists for the further development of the Russian chemical industry, the issue of nurturing own professionals-generators of new ideas, who will be able to elevate national discoveries to a global level, becomes crucial. Another obstacle to advancing a strong chemical base is connected with the difficulty of retaining such talented workers within Russian companies to prevent the "leakage" of intellectual value into the hands of foreign competitors.

In the light of these two stated issues, a possible arises: employers should suggest attractive and favourable conditions for the most skillful employees. Due to their unique mindset, such talented individuals often require someone equal to them, who can meet their demands on a professional and personal level, someone whom the employee can rely on and who also possesses a high level of emotional intelligence. Therefore, the importance of individual management is emphasised, where behind each talented worker stands an intellectually developed partner-entrepreneur who can nurture them through an exceptional connection between each other building during professional interactions. The concept of "first among equals" emerges as one of the key principles in the management of such a type.

### References

- [1] Russian chemical industry is livening up // Delovoy Profil: website. – Moscow. - 2011-2024. – URL: <https://delprof.ru/press-center/open-analytics/itogi-razvitiya-khimicheskoy-otrasli-v-rf-v-2023-godu/>. – Issue date: 29.12.2023.
- [2] 10 biggest companies in the chemical and oil-chemical industry in the RAEX-600 rating of 2022 // RAEX : official website. – 2015- 2024. – URL: [https://raex-rr.com/largest/including\\_industry/chemical\\_industry/2022/](https://raex-rr.com/largest/including_industry/chemical_industry/2022/). – Issue date: 24.11.2022.
- [3] HeadHunter : official website. – Moscow, 2000-2024. - URL: <https://hh.ru/>. – Access date: 10.04.2024.

LONG-TERM STRATEGIES FOR THE FORMATION OF REGIONAL PHARMACEUTICAL CLUSTERS AND THE IMPLEMENTATION OF THE PHARMACEUTICAL INDUSTRY'S PRODUCT POLICY IN THE FACE OF SANCTIONS USING A BREAKTHROUGH POSITIONING TOOL

*Laptenko V.Y.<sup>1</sup>, Shcheglov M. Y.<sup>2</sup>, Pashkus N.A.<sup>3</sup>*

<sup>1</sup> Herzen State University, St. Petersburg, Russia  
Student

[vlaptenko@yandex.ru](mailto:vlaptenko@yandex.ru)

<sup>2</sup> St. Petersburg State University, St. Petersburg, Russia  
Student

<sup>3</sup> Herzen State University, St. Petersburg, Russia

Today, the pharmaceutical market is the leading direction of the innovative chemical industry. Under the conditions of sanctions from Western countries, the Russian pharmaceutical industry has faced serious problems, in particular, caused by a large volume of drugs requiring prompt replacement with Russian analogues. To a certain extent, the industry has already increased its potential through the effective implementation of major innovative projects during the COVID-19 pandemic and the subsequent recovery period. During this period, it became clear that regional pharmaceutical clusters are coping best with the increasing burden on the industry during a period of shortage of imported drugs. The analysis shows that the further development of regional pharmaceutical clusters will allow the pharmaceutical industry to best implement the policy of import substitution and start working on import conservation, creating world-class drugs and correctly positioning them on the market.

Indeed, increasing the efficiency of the pharmaceutical industry can occur according to the cluster principle, which implies the nomination of the flagship regions of Russia in which pharmaceutical clusters are being formed. The development of regional pharmaceutical clusters requires the application of a well-thought-out strategy that takes into account the choice of promising strategic solutions in the field of positioning and promotion of manufactured drugs. The choice of the right strategic approaches can be carried out using a breakthrough positioning model modified by the authors to assess the competitiveness of pharmaceuticals sold by a regional cluster. This marketing strategic tool allows us to identify promising areas of positioning of Russian drugs produced by regional pharmaceutical clusters.

With this tool, all drugs can be divided into four groups, depending on the severity of their production and promotion of the technological and stylistic component. Each product group has its own long-term strategic solutions. However, the risks of choosing different types of strategic decisions will also vary greatly. Thus, using another strategic analysis tool based on the use of matrix mechanisms, in particular, the McKinsey matrix and the hierarchy analysis method, it is possible to develop models of competitiveness of pharmaceutical products for different product groups in accordance with the breakthrough positioning tool. The construction of such models makes it possible to identify the most attractive strategic positioning zones for pharmaceuticals and high-risk zones that can be minimized when choosing another method of positioning a pharmaceutical product.

A promising strategic policy for the development of the pharmaceutical industry requires building a balanced portfolio of pharmaceutical products within a regional cluster. This will make it possible to support innovative drugs being brought to the market through successful products that have achieved widespread fame and popularity. Moreover, the formation of a regional data bank on drugs launched in development, as well as the accumulation of a regional fund to support innovative projects in the biochemical and pharmaceutical fields, will create opportunities for the successful innovative development of pharmaceutical enterprises of all types of the cluster, including small and medium-sized ones.

# SYNTHESIS AND INVESTIGATION OF CU-CONTAINING DEEP OXIDATION CATALYSTS FOR A FLUIDIZED BED BASED ON SPHERICAL $\gamma$ - $\text{Al}_2\text{O}_3$ STRENGTHENED WITH MAGNESIUM

*Lyulyukin A.P.<sup>1,2</sup>, Dubinin Y.V.<sup>1</sup>, Yakovlev V.A.<sup>1</sup>*

<sup>1</sup> Institute of Catalysis SB RAS, Novosibirsk, Russia

<sup>2</sup> Novosibirsk State University, Novosibirsk, Russia

Master student, bachelor

[lyulyukin2@catalysis.ru](mailto:lyulyukin2@catalysis.ru)

The current stage of energy development is characterized by the dominance of energy conservation and environmental priorities. In order to optimize global resource consumption a strong emphasis has been put on wastes, substandard fuels and renewables as possible energy carriers, alongside more traditional options, such as fossil fuels. The conventional use of high-temperature combustion (usually about 1000-1200 °C) does not provide safe and efficient processing of most substandard fuels and wastes. Moreover, high temperature combustion is among the leading sources of heat and harmful substances pollution. Other well-known combustion approaches have similar disadvantages: abundant emissions of toxic products into the atmosphere, increased capital costs due to large equipment dimensions, explosion and fire hazard of systems and harsh requirements for structural materials due to high temperatures of the process [1].

The unsuitability of conventional furnaces for substandard fuels combustion necessitates the creation of new technologies. Combustion of solid fuels and wastes in a fluidized bed has been widely implemented since the mid-70s. Initially, this approach involves the use of an inert material for heat and mass transfer. However, the process temperature remains at high level (800-1000 °C). In this regard, high levels of harmful emissions remain, requiring additional gas purification.

An innovative fluidized bed combustion technology, capable of processing various substandard fuels in an economically efficient and environmentally safe manner was developed in the Boreskov Institute of Catalysis SB RAS [2]. The main advantages of the technology were achieved by the use of a deep oxidation catalyst which eliminates most of the problems, plaguing established combustion techniques [3].

Nevertheless, currently available deep oxidation catalysts have low mechanical strength and requires constant additional loading of the bed material. In addition, toxic chromium compounds are often used in the production of deep oxidation catalysts for fluidized bed processes.

This work is devoted to the synthesis and investigation of a chromium-free, Cu-containing catalyst based on magnesium-hardened spherical aluminum oxide granules. To achieve this goal, experiments were conducted to optimize the preparation conditions, as well as to study the physico-chemical properties of the resulting copper magnesium catalyst. In the study of mechanical, structural and textural characteristics, the following analysis methods were used: low-temperature nitrogen adsorption, abrasion, crushing, X-ray phase analysis (XRF), scanning electron microscopy (SEM), determination of the 50% CO conversion temperature, elemental analysis.

## References

- [1] *Chemistry for sustainable development* **2001**, 9, 97
- [2] *The method of burning fuels* **1983**, patent RF № 826798
- [3] *Russian Journal of Applied Chemistry* **2019**, 92, 614

## Acknowledgements

This work was supported by the Ministry of Science and Higher Education of the Russian Federation within the governmental assignment for Boreskov Institute of Catalysis (project FWUR-2024-0038).

## CHOLESTEROL OXIDASE FROM STREPTOMYCES LAVENDULAE AS A PROSPECTIVE BIOCATALYST FOR BUTTER ANALYSIS

Maksimova B. B.<sup>1</sup>, Gritsenko M. M.<sup>2</sup>, RI Al-Shehadat<sup>3</sup>

<sup>1,2,3</sup> ITMO University, St. Petersburg, Russia

Student

[maksimova55535@gmail.com](mailto:maksimova55535@gmail.com)

Recently, the number of cases of butter adulteration has increased due to the fact that the production of vegetable fats is cheaper than the production of animal fats, which significantly reduces the cost of the final product [1]. However, unlike animal fats vegetable fats, do not contain cholesterol [2]. Literature shows that the cholesterol content of milk fat varies from 204.3 to 382.4 mg/100 g [3]. In butter, this indicator averages 220-350 mg/100 g [4]. High-performance liquid chromatography is usually used for the qualitative and quantitative determination of cholesterol in oils; however, this method is relatively expensive and time-consuming. As such, it is necessary to develop a quick and cost-effective method for the determination of cholesterol in butter. One such approach is based enzymatic cholesterol oxidation to produce hydrogen peroxide that can then be detected.

The main producers of cholesterol oxidase enzyme are various microorganisms, including fungi of the genera *Aspergillus*, *Colletotrichum*, *Myrothecium*, *Penicillium*, *Pleurotus* and bacteria of the genera *Arthrobacter*, *Bacillus*, *Glutamicibacter*, *Pseudoarthrobacter*, *Sporosarcina*, *Metabacillus*, *Paenarthrobacter*, *Brevibacterium*, *Corynebacterium*, *Cellulomonas*, *Lactobacillus*, *Pseudomonas*, *Rhodococcus*, and *Streptomyces*. As a result of screening various strains, it was found that *Cellulomonas* and *Streptomyces* bacteria exhibit the highest productivity in cholesterol oxidase [5]. A *Streptomyces lavendulae* strain capable of producing both intracellular and extracellular forms of the enzyme was selected for further work. Initially cultivation was carried out on Chapek's medium; however, over the course of the study, the optimal nutrient medium of the following composition was selected: yeast extract - 1.2 g, malt extract - 0.6 g, peptone - 1.5 g, MgSO<sub>4</sub>×5H<sub>2</sub>O - 0.1725 g, NaCl - 0.15 g, KH<sub>2</sub>PO<sub>4</sub> - 0.3 g, agar - 8 g, potato starch - 4.5 g. Such medium results in maximum productivity of *S. lavendulae* strain on the target enzyme.

Thus, in this work the producer of cholesterol oxidase - *Streptomyces lavendulae* - was selected and the nutrient medium for its cultivation was optimized. This will allow us to obtain the enzyme for the creation of an express method for the determination of cholesterol in butter, as an alternative to expensive HPLC.

### References

- [1] Derewiaka D. et al. Determination of the adulteration of butter //European Journal of Lipid Science and Technology. – 2011. – T. 113. – №. 8. – C. 1005–1011.
- [2] Sun Y. et al. Palm oil consumption increases LDL cholesterol compared with vegetable oils low in saturated fat in a meta-analysis of clinical trials //The Journal of nutrition. – 2015. – T. 145. – №. 7. – C. 1549–1558.
- [3] Precht D. Cholesterol content in European bovine milk fats //Food/Nahrung. – 2001. – T. 45. – №. 1. – C. 2–8.
- [4] Uysal R. S. et al. Determination of butter adulteration with margarine using Raman spectroscopy //Food chemistry. – 2013. – T. 141. – №. 4. – C. 4397–4403.
- [5] Pathak L. et al. Artificial intelligence versus statistical modeling and optimization of cholesterol oxidase production by using *Streptomyces* sp //PloS one. – 2015. – T. 10. – №. 9. – C. e0137268.

## MODIFIED IRON-BASED CATALYSTS FOR PRODUCING VALUABLE CHEMICAL PRODUCTS

*Maltsev G.I.<sup>1,2</sup>, Dokuchits E.V.<sup>2</sup>, Minyukova T.P.<sup>2</sup>*

<sup>1</sup> Novosibirsk State University, Novosibirsk, Russia

<sup>2</sup> Boreskov Institute of Catalysis SB RAS, Novosibirsk, Russia

Student

[g.maltsev@g.nsu.ru](mailto:g.maltsev@g.nsu.ru)

Emissions of carbon dioxide into the atmosphere, along with methane emissions, are the main cause of enhancing the greenhouse effect. To reduce the CO<sub>2</sub> content in the atmosphere, its injection into depleted gas fields and chemical binding with hydrogen to produce various valuable chemical products, including higher hydrocarbons and alcohols, are proposed.

In a two-stage reaction of CO<sub>2</sub> hydrogenation, carbon monoxide is formed in the first stage, and Fischer-Tropsch synthesis products are formed in the second stage. Iron-containing catalysts are the most active in this reaction and can be modified with potassium to reduce methane selectivity, cobalt to increase hydrocarbon yield, and manganese to increase selectivity towards light olefins [1,2].

The aim of this work is to determine the optimal composition of an iron-containing catalyst for the synthesis of higher C<sub>5+</sub> hydrocarbons. Samples were synthesized by impregnation method with varying iron content ( $w_{Fe} = 2.5-10\%$ ), potassium ( $n_K/n_{Fe} = 0-0.60$ ), cobalt ( $n_{Co}/n_{Fe} = 0.07-0.21$ ), and manganese ( $n_{Mn}/n_{Fe} = 0.11-0.38$ ). Aluminum oxide  $\gamma\text{-Al}_2\text{O}_3$  was used as a carrier, which is readily available and has a high specific surface area.

Tests were conducted at a pressure of 2 MPa, 300-360°C, in a gas mixture of CO<sub>2</sub>+3H<sub>2</sub>. Pre-reduction was carried out in an H<sub>2</sub> atmosphere at a temperature of 450°C. The gas mixture flow rate was adjusted so that the CO<sub>2</sub> conversion rate on all samples fell within the range of 20-40%.

Catalytic tests showed that increasing the potassium content in the iron-containing catalysts reduced methane selectivity to as low as 10.2%, while selectivity towards higher hydrocarbons C<sub>5+</sub> increased, reaching a maximum at a ratio of  $n_K/n_{Fe} = 0.6$ . Manganese modification led to a slight increase in selectivity towards olefins (up to 6.5%), accompanied by a sharp rise in selectivity towards undesired methane and carbon monoxide. Manganese modification using the chosen method proved to be ineffective and did not lead to an increase in selectivity towards desired products. Cobalt modification turned out to be the most promising. With a low cobalt content, a significant decrease in methane selectivity (7.1%) and an increase in selectivity towards higher hydrocarbons C<sub>5+</sub> were observed, reaching a maximum at  $n_{Co}/n_{Fe} = 0.07$ . However, with an increase in cobalt content, methane selectivity significantly increased. The optimal ratio was found to be  $n_{Co}/n_{Fe} = 0.07$ . The specific catalytic activity of cobalt- and potassium-modified samples was twice that of samples modified with potassium alone.

The influence of the active component content in the sample on catalytic properties was investigated. A decrease in the active component content in samples modified with potassium alone led to a predominance of carbon monoxide in the products, as the preferential reaction on iron-containing samples is the first stage of CO<sub>2</sub> hydrogenation. For samples modified with potassium and cobalt, a decrease in the active component content led to an increase in selectivity towards higher hydrocarbons C<sub>5+</sub>. The research showed that the most effective catalyst for CO<sub>2</sub> hydrogenation to obtain higher hydrocarbons C<sub>5+</sub> is one deposited on  $\gamma\text{-Al}_2\text{O}_3$ , containing potassium with  $n_K/n_{Fe} \geq 0.30$ , cobalt with  $n_{Co}/n_{Fe} = 0.07$ , and an active component content of around 3%.

### References

[1] *Int. J. Hydrogen Energy*. **2023**, *48*, 59

[2] *J. CO<sub>2</sub> Util.* **2023**, *67*, 102321

### Acknowledgements

This work was supported by the Ministry of Science and Higher Education of the Russian Federation within the governmental assignment for Boreskov Institute of Catalysis (project FWUR-2024-0033).

## APPLICATION OF LEAN PRODUCTION IN THE CHEMICAL INDUSTRY AS A TOOL TO COMBAT TECHNOGENIC DISASTERS

Manzhosau Y.A.

St. Petersburg State University, St. Petersburg, Russia

Student

[egmanzhosov@gmail.com](mailto:egmanzhosov@gmail.com)

Originating at the Japanese enterprise TOYOTA, the concept of lean manufacturing, which is based on maximizing quality and minimizing waste, can serve as a tool for improving the quality of products of chemical enterprises and reducing the likelihood and damage from man-made disasters. In particular, to reduce the likelihood of man-made disasters and minimize damage when they occur, two main groups of methods can be distinguished: control and optimization of materials.

- andon - a tool used to warn and inform managers about problems associated with the production process;

- jidoka - a technique aimed at stopping equipment when a malfunction is detected;

- khorenso – regular reports between workers and all levels of management.

This leads to one of the core concepts in lean manufacturing: the gemba - the actual place where the work process occurs. In other words, in lean manufacturing the core part of the organization is the production units. One of the features of large Russian business is high power distance. This leads to difficult communication between production employees and decision makers. In Russian practice, it is common that senior management receives information about the situation in a production unit not from employees, but through a number of managers. In addition to raising management's awareness of production-related problems, Khorosen is also a tool for grassroots initiative, which will allow workers to propose their ideas for improving efficiency and safety in the enterprise.

In addition, lean manufacturing involves delegating most of the control of the production process to production workers. Thus, andon and jidoka suggest that any worker should be able to personally stop the work process without management approval, which will help avoid defects and disasters.

Material optimization includes:

- Kanban is a system for ordering materials, in which an organization, when a material is used up, immediately orders a new one. This method requires high integration with the supplier;

- muda - waste that takes time, but does not bring benefit, in this case the most important are: overproduction and excess inventory.

These techniques are especially relevant for the chemical industry, since it involves working with hazardous substances. This imposes a number of requirements for the storage of materials and waste disposal. The use of lean manufacturing will minimize the amount of hazardous substances stored in the enterprise, which also reduces the likelihood of disasters and damage if they occur. However, to implement these mechanisms, testone requires cooperation with the supplier, which requires continuous contact and long-term cooperation.



## STRATEGIC ANALYSIS OF THE PHARMACEUTICAL MARKET IN THE CONTEXT OF IMPORT SUBSTITUTION AND SANCTIONS

*Shcheglov M.Y.<sup>1</sup>, Blagikh I.A.<sup>2</sup>*

<sup>1</sup> St. Petersburg State University, St. Petersburg, Russia  
Student

[st069668@student.spbu.ru](mailto:st069668@student.spbu.ru)

<sup>2</sup> St. Petersburg State University, St. Petersburg, Russia

Today, thanks to the reasonable policy of the state and the increasing sanctions pressure from the "collective West", the Russian pharmaceutical market is on the rise, which makes it possible to develop new mechanisms for managing economic entities. The development of new management mechanisms requires a thorough analysis of the specifics of the pharmaceutical market, which directly affects the level of market uncertainty and the potential risks of choosing a specific management mechanism. Important features of the pharmaceutical market include, among others:

- very high costs for product research and certification;
- the complexity of developing drugs "from scratch" when implementing an import substitution strategy;
- high proportion of both innovative and pseudo-innovative products;
- a significant proportion of "niche" products;
- significant legal restrictions on the use of marketing tools in the promotion of goods;
- high information asymmetry, which negatively affects the assessment of quality and customer loyalty;
- high dependence on both plant and mineral components (and the quality of their processing) and the efficiency of chemical enterprises synthesizing raw components of pharmaceuticals;
- high dependence on the fashion factor;
- market participants tend to follow "opinion leaders" who are not always competent in medical matters.

One of the most important issues to be resolved in the pharmaceutical market is the level of government support for both the industry as a whole and its individual representatives. In the era of sanctions, there is a need to apply the tools of proactive industrial policy. It should be noted that setting priorities for industrial policy requires an adequate assessment of both competitiveness and the possibility of achieving a certain level of economic security, which requires the development of an appropriate methodology. The research conducted by the authors of the article makes it possible to assess the competitiveness of products and assess the possibility of achieving global competitiveness by various products of the pharmaceutical market.

## Economic aspects of Russian patent activity in the electric accumulator industry

*Temnikov A.A.<sup>1</sup>, Tsenjarik M.K.<sup>2</sup>*

<sup>1</sup> St. Petersburg State University, St. Petersburg, Russia

<sup>2</sup> St. Petersburg State University, St. Petersburg, Russia

PhD student

[st055412@student.spbu.ru](mailto:st055412@student.spbu.ru)

The industry of autonomous energy generation and conservation is growing in the context of the greening of public consciousness, the energy transition and trends towards decentralization. These technologies are also highly relevant for Russia.

According to the International Patent Classification (IPC), code H01M "PROCESSES OR MEANS, e.g. BATTERIES, FOR THE DIRECT CONVERSION OF CHEMICAL ENERGY INTO ELECTRICAL ENERGY" is the main one for registration of new designs of batteries, accumulators and their elements. Due to the high knowledge intensity, the productive implementation of this technologies requires a developed National Innovation System (NIS). In the current investigation, a patent analysis was carried out for the H01M code for Russia from 2000 to July 2023 [1, 2]. Patent holders were divided into individuals and organizations, then organizations were divided by position in the innovation process, type of ownership, industry, etc. The ratio of the number of patents from different patent holders over time since 2000 is shown below (scheme 1). Over the course of 23 years, a gradual increase in the share of patents from state scientific organizations and universities has been clearly visible, while the absolute and relative innovative activity of industrial enterprises has been significantly reduced. On the one hand, this may be due to the transformation of the NIS of Russia according to the theory of Open Innovation (G. Chesborough [3]) - manufacturing enterprises cease to conduct the entire innovation process alone and delegate the generation of innovations to specialized institutions. This coincides with the global trend of transition to a Knowledge Economy. On the other hand, combined with the annual decrease in the number of patents from private scientific organizations and individuals, one can assume a significant increase in the role of the state in science and the declining of private initiative. Pie chart also demonstrates the high role of government projects for innovation in the field of chemical power sources.

The work was supported by St Petersburg University, project 103921985 "Practice-oriented approach to the development of batteries based on organic materials".

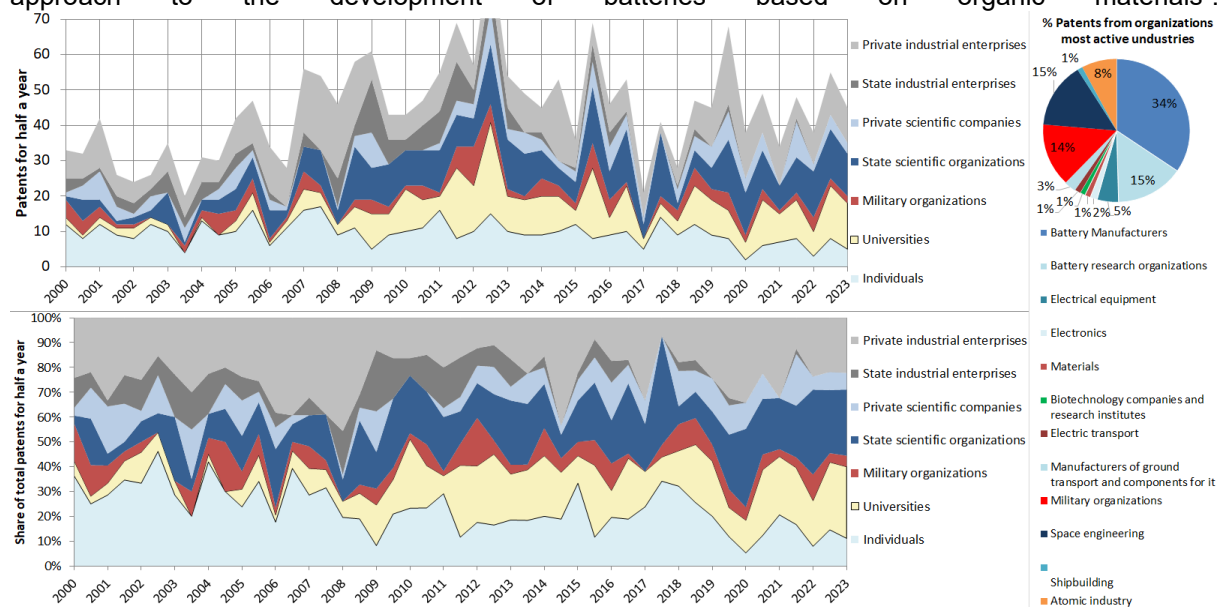

**Scheme 1.** Dynamics of the ratio of the number of filed applications from different patent holders.

### References

1. PATENTSCOPE. Patent Document Database WIPO. URL: <https://www.wipo.int/patentscope/ru/index.html>
2. Search for patents. Digital platform for searching patent information and information on means of individualization from Rospatent. URL: <https://searchplatform.rospatent.gov.ru/>
3. Chesbrough, H.W. (2003). Open Innovation: The new imperative for creating and profiting from technology. Boston: Harvard Business School Press.

# APPLICATION OF THE CLUSTER ANALYSIS TO DETERMINE THE RATIO OF COMPONENTS IN COMPLEX MIXTURES FOR REVERSE ENGINEERING PROBLEMS

*Trukhin I.S.<sup>1</sup>*

<sup>1</sup>Institute of Chemistry, Far Easter Branch of Russian Academy of Science, Vladivostok, Russia  
Researcher, PhD  
[truhin.ivan.91@gmail.com](mailto:truhin.ivan.91@gmail.com)

Currently, the development of reverse engineering methods is becoming increasingly important. The task of reverse engineering is to study the finished product in order to determine its components and reproduce the technology for its production. At the same time, reverse engineering is used not only in cases where the technology is not available, but also for a deeper understanding of the properties and functions of the object under the study. Reverse engineering has applications in various industries. The manufacturing technology of many high-tech products is a commercial secret and industrial enterprises try not to reveal it. In addition, in the current world political situation, states are trying to limit the joint use of goods and developments by sanctions. Reverse engineering makes it possible to reduce the dependence of industries on imports and ensure the industrial sovereignty of the state. Reverse engineering is a powerful tool that can be used to both evade sanctions and reveal trade secrets [1]. One of the important tasks of reverse engineering in the chemical industry is determining the ratio of initial solutions in complex mixtures. Such tasks are relevant for cosmetic products, auto chemicals, paints, oilfields chemistry, etc. In the case when the finished product is prepared by mixing several complex solutions, the main way to determine the ratio of the initial solutions is to use a system of equations based on their chemical composition. But when researching real complex technological mixtures, during the preparation of which the chemical composition of the initial components can change as a result of chemical reactions, or in the process of storage and transportation, the use of a system of equations is often unable to give the correct result, and sometimes even has no solution at all.

The purpose of this work was to develop a mathematical approach based on multivariate statistical methods of analysis, which will allow to reliably determine the ratio of initial solutions in complex natural and technological mixtures based on their chemical composition.

It is known that cluster analysis is used to establish relationships between objects. Cluster analysis is designed to divide objects into homogeneous groups based on their characteristics. Clustering is carried out based on the statistical distance between objects [2]. We discovered that statistical distances can be used to determine the ratio of initial solutions in the mixture. For example, when mixing two solutions, their ratio becomes proportional to the Euclidean distance between them. When three solutions are mixed, the proportions of the components are defined as the ratio of the areas of the triangles that form the mixing pyramid, whose faces are the Euclidean distances between the mixing solutions. This method was tested at one of the oil producing companies in Russia in order to determine the ratio of miscible formation and injected waters in the production of wells. Calculations were carried out using the Statistica 12 software package based on the following water parameters: pH, TDS, content of Cl<sup>-</sup>, Na<sup>+</sup>, K<sup>+</sup>, Ca<sup>2+</sup>, Mg<sup>2+</sup>, HCO<sub>3</sub><sup>-</sup>, Fe<sup>3+</sup>, Sr<sup>2+</sup>, Ba<sup>2+</sup>, SO<sub>4</sub><sup>2-</sup>.

The results obtained by this method have been shown to correlate well with other markers that are commonly used in oil production. It is important that no obvious correlation with the chemical composition of the investigated aqueous solutions was observed. In oilfield chemistry this is due to the fact that in the process of oil extraction, the oil production waters components are involved in various chemical processes, including the scaling, interaction with the reservoir, microbiological processes etc. This shows that in this case it would not be possible to solve this problem without using cluster analysis. An important advantage of the cluster analysis method is the ability to evaluate the statistical significance of parameters, which makes it possible to reduce the influence of components that do not correlate with the mixing. Thus, we propose to use the method of cluster analysis in similar tasks of reverse engineering to determine the ratio of solutions in complex mixtures, because it is able to take into account a wide range of parameters and find out non-obvious relationships between objects.

## References

- [1] *Technovation*. **2023**, 125, 102791.
- [2] *Neftegaz.RU*. **2022**, 5-6 [125-126], 77.

## Acknowledgements

The work was carried out with the financial support of the Ministry of Education and Science, state assignment number 0265-2019-0002, using the equipment of the Center for Collective Use of the Far Eastern Center for Structural Research of the IC FEBRAS.

## RUSSIA'S CHEMICAL INDUSTRY DURING THE PERIOD OF SANCTIONS PRESSURE: A COMPREHENSIVE REVIEW

*Voronin V.A.<sup>1</sup>, Khayrullova A.V.<sup>2</sup>, Pashkus V. Y.<sup>3</sup>*

<sup>1</sup> St. Petersburg State University, St. Petersburg, Russia, Student

<sup>2</sup> St. Petersburg State University, St. Petersburg, Russia, Student

<sup>3</sup> St. Petersburg State University, St. Petersburg, Russia, Doctor of Economics, Professor  
[sevy@inbox.ru](mailto:sevy@inbox.ru), [mega.khayrullova@mail.ru](mailto:mega.khayrullova@mail.ru)

**Introduction.** The chemical industry in Russia until 2022 was one of the most dynamic industries, with production growth of about 80 percent over the decade from 2011 to 2021, but after the imposition of sanctions, production decreased. In 2022, another Western sanctions were imposed on Russia, which included restrictions, on the one hand, on the purchase of Russian goods, on the other, on the supply of machinery, equipment and other products to Russia. This has affected, among other things, the chemical industry. Thus, a comprehensive review of the chemical and petrochemical industry is currently an urgent topic for research.

**Structure.** The contribution of the chemical industry to the GDP of the Russian Federation, according to preliminary data, increased by 1 percentage point last year, rising to the level of 1.3%.

The chemical industry, which is under the jurisdiction of the Ministry of Industry and Trade of the Russian Federation, includes the production of basic chemicals (mineral fertilizers, soda ash, caustic soda, other chemicals), paints, chemical fibers and yarns, plastic products, other chemicals, including special chemicals, as well as tires and rubber products, as well as pharmaceutical production.

**Domestic production and market.** Domestic production in the chemical industry decreased by about 3.8% in 2022, mainly due to a decrease in exports of chemical products, especially mineral fertilizers. In 2023, the production of chemical products (excluding pharmaceuticals) increased by 4.6% compared to 2022.

**Foreign trade.** In recent decades, Russia has been an exporter of petrochemical products (polymers, rubber, plastics), chemicals (dyes, acids, alkalis), fertilizers, as well as other important goods. In return, the country bought raw materials and equipment. The sales market for Russian companies was represented by states from almost all over the world. In 2022, the trade turnover with Europe related to the chemical industry has significantly decreased. Russia partially solved the problem of a shortage of supplies of high-tech industrial products through an import substitution policy, and also expanded its sales market in Asia and Latin America, which contributed to maintaining the stability of trade in chemical and related products.

**Stock Market.** At the end of 2021, the Russian stock market is falling. This happened against the background of statements by the Western media about Russia's plans towards Ukraine, as well as the general political situation. The fall also affected the stock market of Russian companies producing chemical products. The Moscow Chemical and Petrochemical Exchange Index (MOEXCH) fell by more than 13% from December 2021 to February 2022. However, by April, the market valuation of the companies had declined again. The fall also occurred after the announcement of partial mobilization in Russia. This was followed by almost a year of continuous growth, after which the entire Russian stock market, including chemical companies, went into correction.

**The main trends.** Now, the chemical sector of the Russian Federation, like the entire Russian economy, is in the process of restructuring. The decline in production in one area occurs against the background of the rise in production in another. While one company is operating at a loss, the other is increasing revenue. Some companies have found new investors, suppliers and sales markets, have been able to make changes in the personnel and management system, and some have not yet. Also, the chemical industry is actively supported by the state through additional subsidies during a difficult period.

**Conclusions.** The chemical industry has withstood the first two years of large-scale economic sanctions from the West. There was no serious decline anywhere – production, trade, as well as the stock market quickly recovered to previous levels, and somewhere they were surpassed. New trends are just being formed, so it is impossible to say exactly which trend of the industry's development will become long-term. However, based on the latest news and statistics, it can be argued that the state of the chemical industry is currently in a satisfactory state.



# **ABSENTEE PARTICIPANTS**

RATIONAL USAGE OF NON-TARGET PETROCHEMICAL FLOWS TO REDUCE THE RISK OF ECOCATASTROPHES

*Nachaeva S.A.<sup>1,2</sup>, Babintseva M.V.<sup>1</sup>, Zanozin I.Y.<sup>1</sup>, Repina A.S.<sup>1</sup>, Zanozina I.I.<sup>1</sup>*

<sup>1</sup>Middle Volga Oil Refining Research Institute PJSC, Novokuybyshevsk, Russia

<sup>2</sup>Samara National Research University, Samara, Russia

PhD Student

[SA\\_Pudovkina@sni.rosneft.ru](mailto:SA_Pudovkina@sni.rosneft.ru)

Removing asphalt-resin-paraffin deposits (ARPD) is a very important task, since deposits consist of highly dispersed mixture of paraffin, asphaltenes, resins, mineral impurities, etc. They can accumulate on oilfield equipment walls. Also, deposits can't fully dissolve and disperse in crude oil streams during its production, causing clogging of oilfield equipment, which leads to anthropogenic disasters, because the ARPD compounds have a toxic effect on the soil, changing its water-physical properties.

One of the asphaltene-resin-paraffin deposits diluting methods is usage of chemical solvent. It is rational to use a mixture of petrochemical production wastes and surfactants as solvents. The mixture of these can reduce the negative impact on the ecology and significantly reduce the cost of deposits utilization. In addition, the use of petrochemical wastes products will reduce the value of an effective ARPD solvent.

The purpose of this work is choosing an effective solvent for the ARPD removal. The effectiveness of solvent, obtained from petrochemical wastes, is defined based of its technological properties: dissolving, detergent and dispersing ability.

There are a number of requirements to the solvent. One of the main is the absence of corrosive-active impurities, in particular, organochlorine compounds. Therefore, the first stage of work was to study the properties of the solvent. The results showed that it is non-toxic, has a very low pour point, low viscosity and high boiling point. Also it is corrosion resistant to metals. These properties indicate the possibility of using the solvent in oilfield equipment. But to determine the efficiency of solvent, we need to be sure in its technological properties.

The effectiveness of the solvent depends on the composition of ARPD. The second step of research is to determine the composition and properties of a number of sediment samples, such as content of water, mechanical impurities, asphaltenes, resins and paraffin. According to the composition of ARPD we determined the types of deposits. Some of them are paraffinic, other are asphaltenic.

For each ARPD type the solvent is selected individually according to its technological properties, obtained during laboratory analysis. The main criteria of solvent efficiency is its detergent ability. Obtained results showed, that the analyzed solvent shows its high efficiency against paraffinic ARPD.

Therefore, the analyzed solvent is efficient in washing out asphaltene-resin-paraffin deposits. The usage of petrochemical wastes as a main component of solvent can decline the value of solvent. It is also a great way to reuse raw materials prepared for utilization, lower environmental damage and effectively remove ARPD.

## ECONOMIC EFFICIENCY OF USING A TWO-FRACTION POLYDISPERSE POLYMER COMPOSITE

Savitskaya Y.A., Kharlamova K.I.

MIREA – Russian Technological University, Lomonosov Institute of Fine Chemical Technology,  
Moscow, Russia

Student

[juli.ska@mail.ru](mailto:juli.ska@mail.ru)

Disperse-filled polymer composite materials (DFPCMs) are widely used due to their low density. Their physical and mechanical properties can be regulated over a broad range through changes in the structure type and characteristics of filler particles. The cost of final products made of DFPCMs is usually lower than those made of polymer materials without adding the filler, as there is a significant difference in cost between fillers and the majority of conventional thermoplastics and thermosets.

In order to calculate the maximum possible economic value, it is necessary to determine the maximum filler content parameter ( $\varphi_m$ ). The cost of the product would decrease with the reduction of the polymer matrix proportion, which could be achieved by increasing the number of the filler particles. To increase the value of the parameter  $\varphi_m$ , a special dense structure has been developed by adjusting the grain size distribution. These close-grained structures usually consist of two or three fractions of fillers with different particle sizes.

The generalized parameter  $\Theta$  made it possible to classify all DFPCMs into the types of structures (diluted (DS), low-filled (LFS), medium-filled (MFS; MFS-1 up to the yield point and MFS-2 with a yield point), highly filled (HFS) and ultra-high-filled systems (UHFS)). It takes into account the parameter  $\varphi_m$  and the filler's characteristics. The generalized parameter  $\Theta$  determines the proportion of the polymer matrix (binder) for organizing a continuous layer between dispersed filler particles in the DFPCM.

The aim of this research is to assess the economic efficiency of two-fraction polydisperse polymer composite use.

Micronized silica sand flour SIKRON SF800 with a size of 2  $\mu\text{m}$  (Quarzwerke Group Ulyanovsk, Russia) and quartz sand grade 10 with a size of 10  $\mu\text{m}$  (Batolit, Russia) were used as a filler, with granular polyethylene LDPE (Technoimpex, Russia) being applied as a polymer.

In order to calculate the maximum economic possible benefit, the parameter  $\varphi_m$  was determined using the compaction curves obtained by means of the I11M universal testing machine (TOUCHPRIBOR-KB) in compression mode (according to GOST 4651-2014). The cost of the final product is calculated using formula 1 [1].

$$C_{CM} = \varphi_p C_p + \varphi_m C_f \quad (1)$$

where  $C_{CM}$  is the cost of a composite material;  $\varphi_p$  and  $C_p$  represent the content and cost of the polymer matrix respectively;  $\varphi_m$  is the maximum content of mixture of dispersed fillers in different sizes,  $C_f$  represents the average cost for two types of fillers.

Figure 1 shows that it is more cost-efficient to use DFPCMs instead of the unmodified polymer. The two-fraction systems with increased parameter  $\varphi_m$  are cheaper as compared to the one-fraction systems.

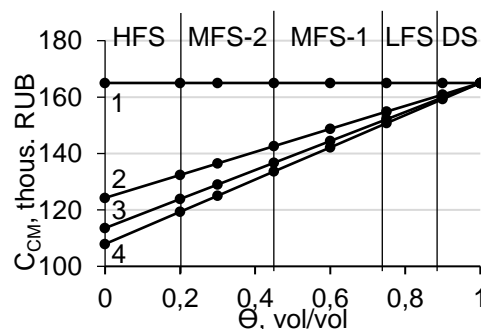

**Figure 1.** Relation between generalized parameter  $\Theta$  and price of: 1 – the polymer without filler; 2 – the polymer with SF800; 3 – the polymer with quartz grade 10; 4 – the two-fraction polydisperse polymer composite

Research [2] recommends using MFS-1 in order to increase mechanical properties. In the structures concerned, the value of the two-fraction polydisperse polymer composite is lower by ~5% as compared to the price of the polymer with SF800 and it is lower by ~14% as compared to the cost of the polymer without a filler.

## References

- [1] *Plasticheskie Massy*, **2011**, 10, 60-64  
 [2] *Plasticheskie Massy*, **2020**, 9-10, 13-18

