

Study of flucton-flucton interaction in dd-collisions at NICA SPD

[Vechernin V.V.](#), Yurchenko S.V.
Saint-Petersburg State University
v.vechernin@spbu.ru

VII SPD Collaboration Meeting

**Institute of Nuclear Physics,
Almaty, May 20-24, 2024**

Centrality classes in dd collisions

- Impact parameter b is not suitable!
- Classes on the number of participants (spectators):

In a picture without fluctons:

- 1) $N+N$ (p+p, p+n, ...)
- 2) $2N+N$, $N+2N$
- 3) $2N+2N$

The experimental problem of the division of all dd events into centrality classes.

(Can be useful for a wide range of research.)

Principal possibility of registering a spectator neutron by ZDC??

In a picture with fluctons:

- 4) $f+N$, $N+f$
- 5) $f+2N$, $2N+f$
- 6) $f+f$

Flucton-flucton interaction in dd collisions

f+f in dd collisions - New and Clear!

- It can be studied **only in new cumulative region of large transverse momenta in mid-rapidity region at NICA** (not in the traditional cumulative region of fragmentation of one of the nuclei).
- There are **no additional interactions in dd collision**, compared with collisions of heavier nuclei, if both deuterons are in flucton configuration at the moment of collision. =>
- The possibility to register, in addition to the cumulative particle, the **particles formed from fragmentation of the flucton residue**.
- **Higher frequency of dd collisions** that can be recorded by the SPD, compared to the slower MPD (important for a registration of rare cumulative events).
- The studies in new cumulative region becomes **possible due to the moderate energy of the NICA** collider and is completely impossible at ultrahigh energies of the RHIC and LHC.

Modeling of the dd scattering within the framework of the Glauber approach

Both analytical and MC modeling without fluctons (Belokurova S.N.)

$$T_A(a_1, \dots, a_A) = \prod_{j=1}^A T_A(a_j). \quad \Rightarrow \quad T_{d_1}(a_1, a_2) = T_{d_1}(a_1)T_{d_1}(a_2)\delta(a_1 - a_2).$$

$$T(a) = \int |\Psi(a, z)|^2 dz \quad \Psi(r) = C(e^{-\gamma r} - e^{-\mu r})/r, \quad C^2 = \frac{\gamma(\gamma + \mu)\mu}{2\pi(\mu - \gamma)^2},$$

$\gamma = 45,8 \text{ M}\text{\AA}\text{B}, \quad \mu = 140 \text{ M}\text{\AA}\text{B}.$

$$\sigma(a) = \exp\left(-\frac{a^2}{r_N^2}\right) \quad \sigma_{NN} \equiv \int db \sigma(b), \quad \sigma_{NN} = \pi r_N^2.$$

$$\langle N_{coll}(\beta) \rangle = 4\chi(\beta) \quad \chi(\beta) \equiv c^{-1} \int \sigma(a - b + \beta) (T_{d_1}(a))^2 da (T_{d_2}(b))^2 db,$$

$$V[N_{coll}(\beta)] = \dots$$

$$\langle N_w^{d_1}(\beta) \rangle + \langle N_w^{d_2}(\beta) \rangle = \dots$$

$$V[N_w^{d_1}(\beta) + N_w^{d_2}(\beta)] = \dots$$

$$P_{2-2}(\beta) = c^{-1} \int \sigma(a-b+\beta)\sigma(a+b+\beta)\sigma(-a+b+\beta)\sigma(-a-b+\beta) (T_{d_1}(a))^2 da (T_{d_2}(b))^2 db$$

$$P_{2-1}(\beta) = 2c^{-1} \int \sigma(a-b+\beta) [1 - \sigma(a+b+\beta)] [1 - \sigma(-a+b+\beta)] \sigma(-a-b+\beta) (T_{d_1}(a))^2 da (T_{d_2}(b))^2 db$$

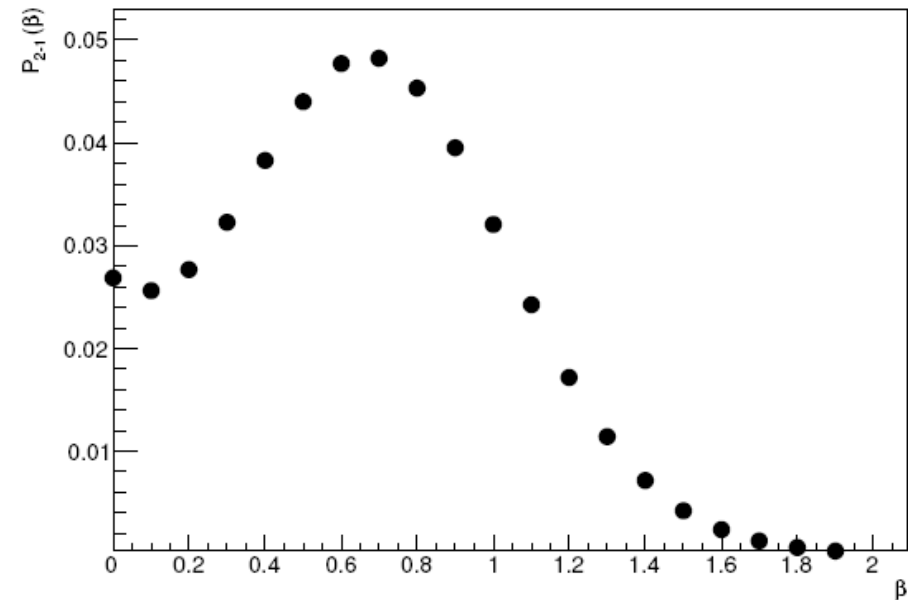
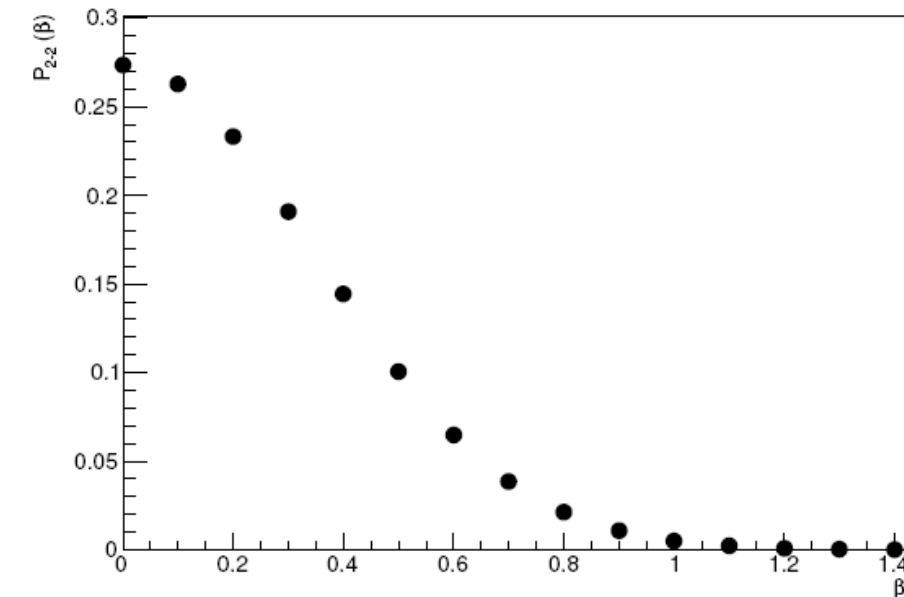

min.bias:

$$P_{2-1}^{min.bias} = 0.0067$$

$$P_{2-2}^{min.bias} = 0.0046$$

Variation of the number of participant and NN collisions in AA (dd) interactions

Vechernin, V.V. and Nguyen, H.S. Phys. Rev. C 84 (2011) 054909

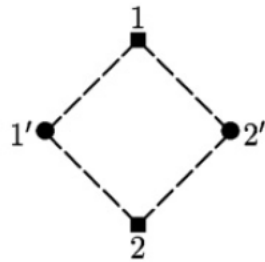
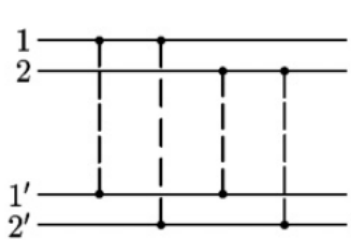

$$\chi(\beta) \equiv \int da db T_A(a) T_B(b) \sigma(a - b + \beta)$$

$$\approx \sigma_{NN} \int da T_A(a) T_B(a + \beta)$$

$$\rho_{\text{opt}}(N_{\text{coll}}) = C_{AB}^{N_{\text{coll}}} \chi(\beta)^{N_{\text{coll}}} [1 - \chi(\beta)]^{AB - N_{\text{coll}}}$$

$$\sigma_{NN} \equiv \int db \sigma(b),$$



$$I(a) \equiv \int db \sigma(b) \sigma(b + a).$$



So for variation of the number of participant and NN collisions in AA (dd) interactions the general analytical formulas from textbooks (“the optical approximation”):

C.-Y. Wong, Introduction to High-Energy Heavy-Ion Collisions (World Scientific, Singapore, 1994).

R. Vogt, Ultrarelativistic Heavy-Ion Collisions (Elsevier, Amsterdam, 2007).

are not correct and are not supported by MC simulations.

Flucton fragmentation region
Cumulative production at $|t| \ll s$

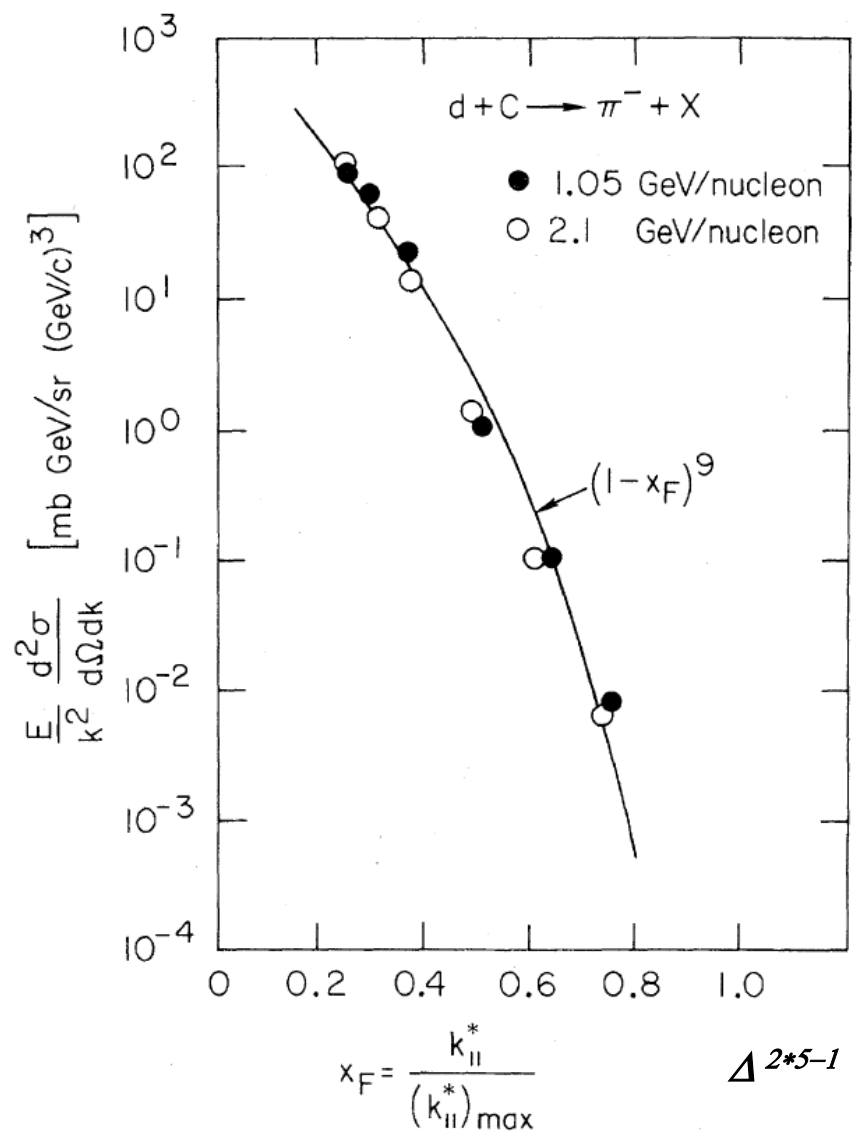
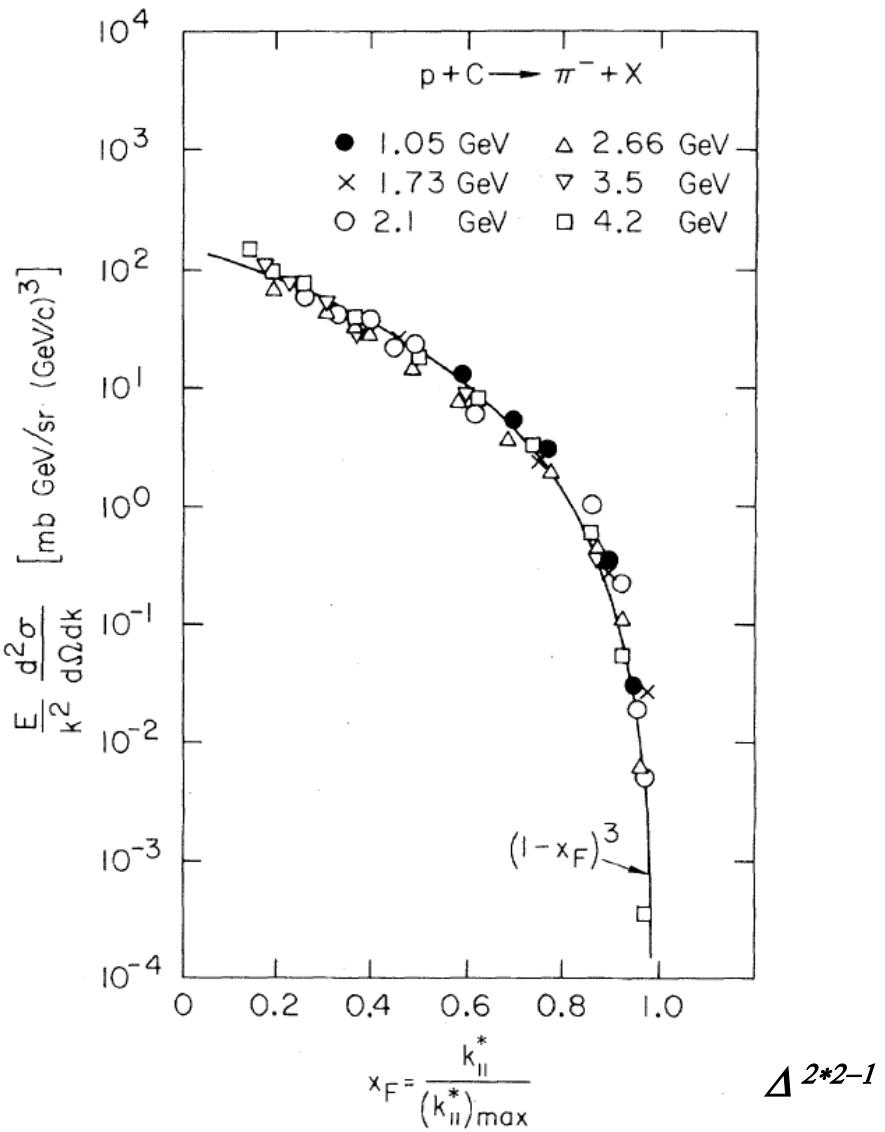

Threshold behaviour of *inclusive cross sections* (quark counting rules) at $|t| \ll s$.
 The experimental points from J. Papp et al., Phys.Rev.Lett. 34, 601 (1975).

Description of the hadron asymptotics at $x \rightarrow 1$

by the intrinsic diagrams of QCD in light-cone gauge
with low- x spectator quarks interact with the target

Brodsky S.J., Hoyer P., Mueller A., Tang W.-K., Nucl.Phys. B369 (1992) 519

Description of the flucton asymptotic at $x \rightarrow f$,

f - the number of nucleons in flucton, n - the number of quarks in flucton, $x_0 = f/n (=1/3)$.

M.A. Braun, V.V. Vechernin, Nucl.Phys. B427 (1994) 614. (DIS in cumulative region)

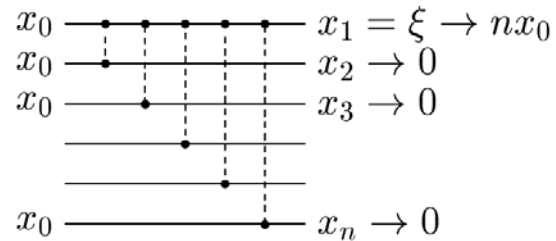
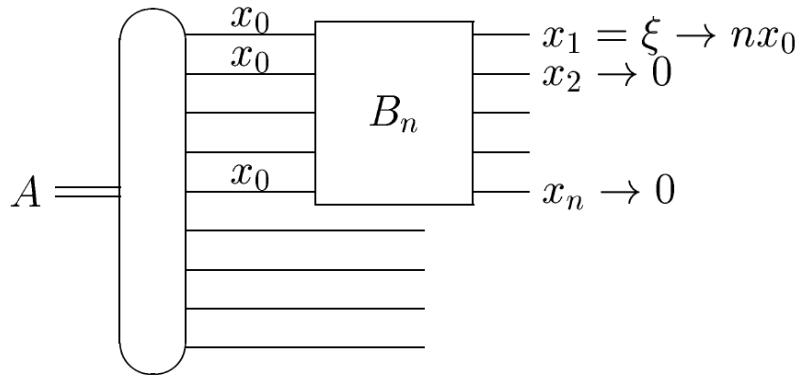

$$\sim \Delta^{2p-1}$$

$$p=n-1$$

$$\Delta = f - \mathbf{x} = nx_0 - \xi$$

At $x_1 \rightarrow f \Rightarrow$ all $x_2, \dots, x_n \rightarrow 0 \Rightarrow$ all $|q_i| \gg m \Rightarrow$
pQCD works \Rightarrow min.number of hard exchanges.
Simple instantaneous Coulomb part dominates
in light-cone gauge.

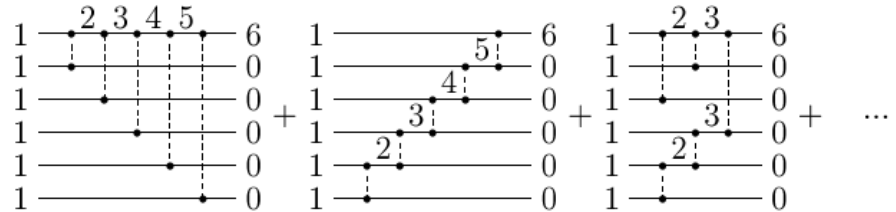

$$\begin{matrix} 1 \\ 1 \\ 1 \\ 1 \\ 1 \\ 1 \end{matrix} \begin{matrix} \text{---} \\ \text{---} \\ \text{---} \\ \text{---} \\ \text{---} \\ \text{---} \end{matrix} \begin{matrix} n \\ 0 \\ 0 \\ 0 \\ 0 \\ 0 \end{matrix} \\ \begin{matrix} \text{---} \\ \text{---} \\ \text{---} \\ \text{---} \\ \text{---} \\ \text{---} \end{matrix} \begin{matrix} \text{---} \\ \text{---} \\ \text{---} \\ \text{---} \\ \text{---} \\ \text{---} \end{matrix} \begin{matrix} n \\ 0 \\ 0 \\ 0 \\ 0 \\ 0 \end{matrix} \\ \begin{matrix} \text{---} \\ \text{---} \\ \text{---} \\ \text{---} \\ \text{---} \\ \text{---} \end{matrix} \begin{matrix} \text{---} \\ \text{---} \\ \text{---} \\ \text{---} \\ \text{---} \\ \text{---} \end{matrix} \begin{matrix} n \\ 0 \\ 0 \\ 0 \\ 0 \\ 0 \end{matrix} \\ \begin{matrix} \text{---} \\ \text{---} \\ \text{---} \\ \text{---} \\ \text{---} \\ \text{---} \end{matrix} \begin{matrix} \text{---} \\ \text{---} \\ \text{---} \\ \text{---} \\ \text{---} \\ \text{---} \end{matrix} \begin{matrix} n \\ 0 \\ 0 \\ 0 \\ 0 \\ 0 \end{matrix} \\ \begin{matrix} \text{---} \\ \text{---} \\ \text{---} \\ \text{---} \\ \text{---} \\ \text{---} \end{matrix} \begin{matrix} \text{---} \\ \text{---} \\ \text{---} \\ \text{---} \\ \text{---} \\ \text{---} \end{matrix} \begin{matrix} n \\ 0 \\ 0 \\ 0 \\ 0 \\ 0 \end{matrix} \\ \begin{matrix} \text{---} \\ \text{---} \\ \text{---} \\ \text{---} \\ \text{---} \\ \text{---} \end{matrix} \begin{matrix} \text{---} \\ \text{---} \\ \text{---} \\ \text{---} \\ \text{---} \\ \text{---} \end{matrix} \begin{matrix} n \\ 0 \\ 0 \\ 0 \\ 0 \\ 0 \end{matrix}$$

$$= \sum_{k=1}^{n-1} C_{n-2}^{k-1} \begin{matrix} 1 \\ 1 \\ 1 \\ 1 \\ 1 \\ 1 \end{matrix} \begin{matrix} \text{---} \\ \text{---} \\ \text{---} \\ \text{---} \\ \text{---} \\ \text{---} \end{matrix} \begin{matrix} k \\ 0 \\ 0 \\ 0 \\ 0 \\ 0 \end{matrix} \\ \begin{matrix} \text{---} \\ \text{---} \\ \text{---} \\ \text{---} \\ \text{---} \\ \text{---} \end{matrix} \begin{matrix} \text{---} \\ \text{---} \\ \text{---} \\ \text{---} \\ \text{---} \\ \text{---} \end{matrix} \begin{matrix} n-k \\ 0 \\ 0 \\ 0 \\ 0 \\ 0 \end{matrix}$$

- the recurrence relation

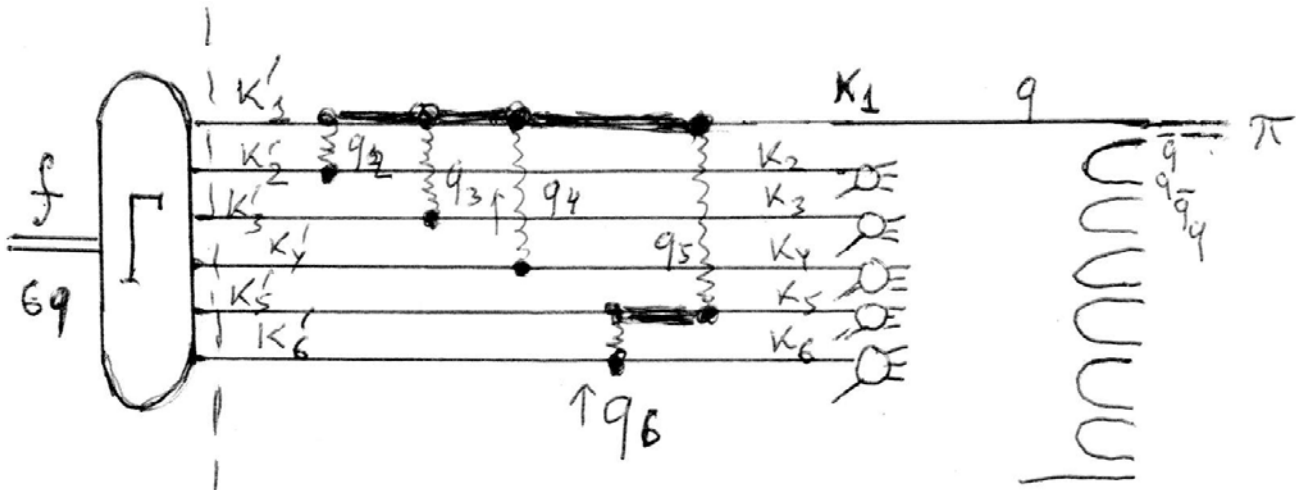

f – number of nucleons which formed flucton
 n – number of quarks in flucton
 $p=n-1$ – number of "donors", stopped quarks

$\Gamma = \Gamma(k'_{+i}, k'_{\perp i})$ then after integration over all k'_{-i} we get:

$\Gamma(k'_{+i}, k'_{\perp i}) \rightarrow \Psi(k'_{+i}, k'_{\perp i})$ – light cone parton wave function of flucton

In all rest parts of the diagram we can put: $k'_{+i} = \frac{f p_+}{n} = \frac{f}{n} p_+ = \frac{1}{3} p_+$

Then we get: $\int \Psi(k'_{-i}, k'_{\perp i}) \delta(\sum_{i=1}^n k'_{+i} - f p_+) \delta^2(\sum_{i=1}^n k'_{\perp i}) \prod_{i=1}^n \frac{dk'_{+i}}{2k'_{+i}} d^2 k'_{\perp i} \sim \bar{\Psi}_{cms}(\{r_i - r_j = 0\})$

Contribution of $(n-1)$ "Gluon" exchanges and $(n-2)$ internal quark propagators limits to constant, when at $x_1 \Rightarrow f$ all $x_2, \dots, x_n \Rightarrow 0$

The main contribution comes from propagators of stopped quarks k_2, \dots, k_n , which defined the longitudinal and transverse momentum dependence.

Scaling of cumulative inclusive cross section in the flucton fragmentation region:

$$f_{\pi}(x, k_{\perp}) \equiv \frac{k_0 d^3 \sigma_{\pi}}{d^3 \mathbf{k}} = C s^0 (f - x)^{2p-1} \Phi_p \left(\frac{k_{\perp}}{m_q} \right)$$

Coherent Quark Coalescence and Production of Cumulative Protons

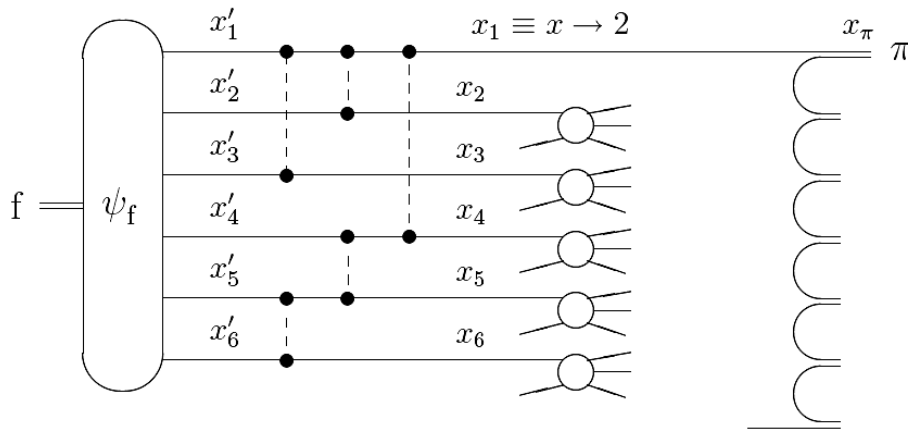

- the cumulative pion production by hadronization of one fast quark

M.A. Braun, V.V. Vechernin, Nucl.Phys.B 427, 614 (1994); Phys.Atom.Nucl. 60, 432 (1997); 63, 1831 (2000)

- the cumulative proton production by **coherent** quark coalescence mechanism:

M.A. Braun, V.V. Vechernin, Nucl.Phys.B 92, 156 (2001); Theor.Math.Phys 139, 766 (2004); V.Vechernin, AIP Conf.Proc.1701 (2016) 060020.

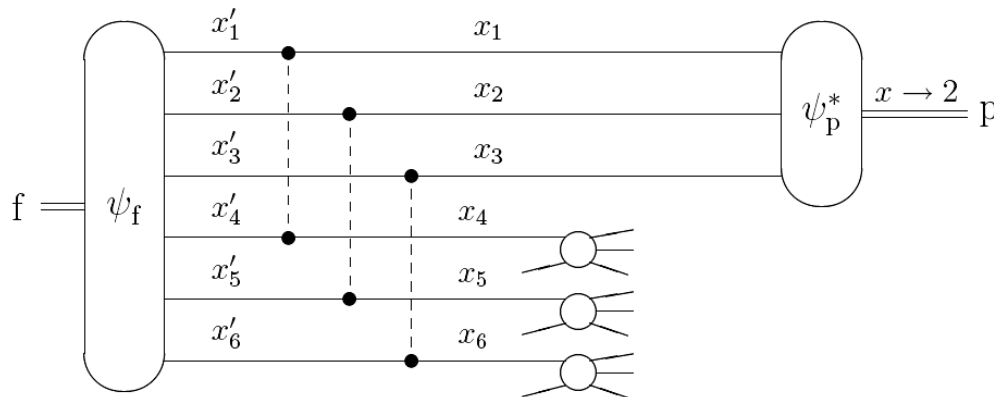

The last **recalls** the few nucleon **short-range correlations** in a nucleus

L.L. Frankfurt, M.I. Strikmann, Phys. Rep. 76, 215 (1981); ibid 160, 235 (1988).

But instead of using the relativistic generalization of non-relativistic NN wave function

the microscopic analysis of the flucton fragmentation process near cumulative thresholds on the base of the intrinsic diagrams of QCD in light-cone gauge

Brodsky S.J., Hoyer P., Mueller A., Tang W.-K., Nucl. Phys. B369 (1992) 519.

was developed and applied.

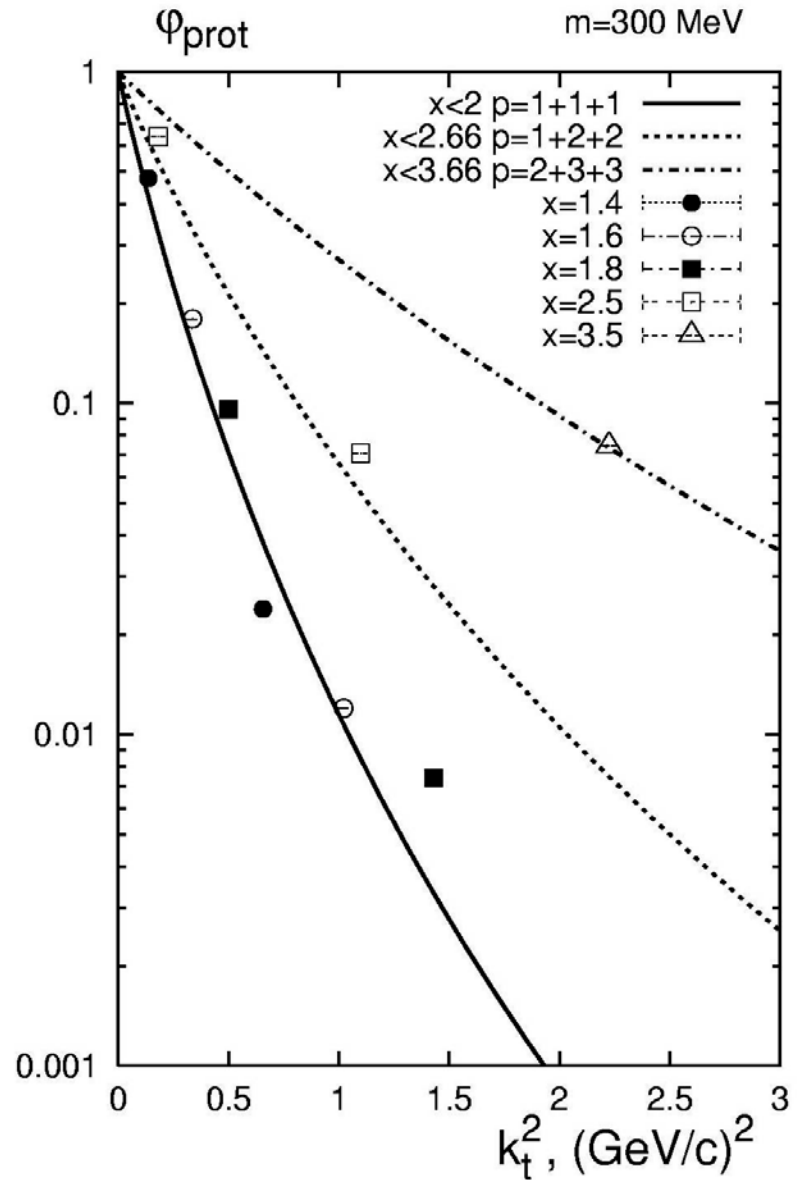
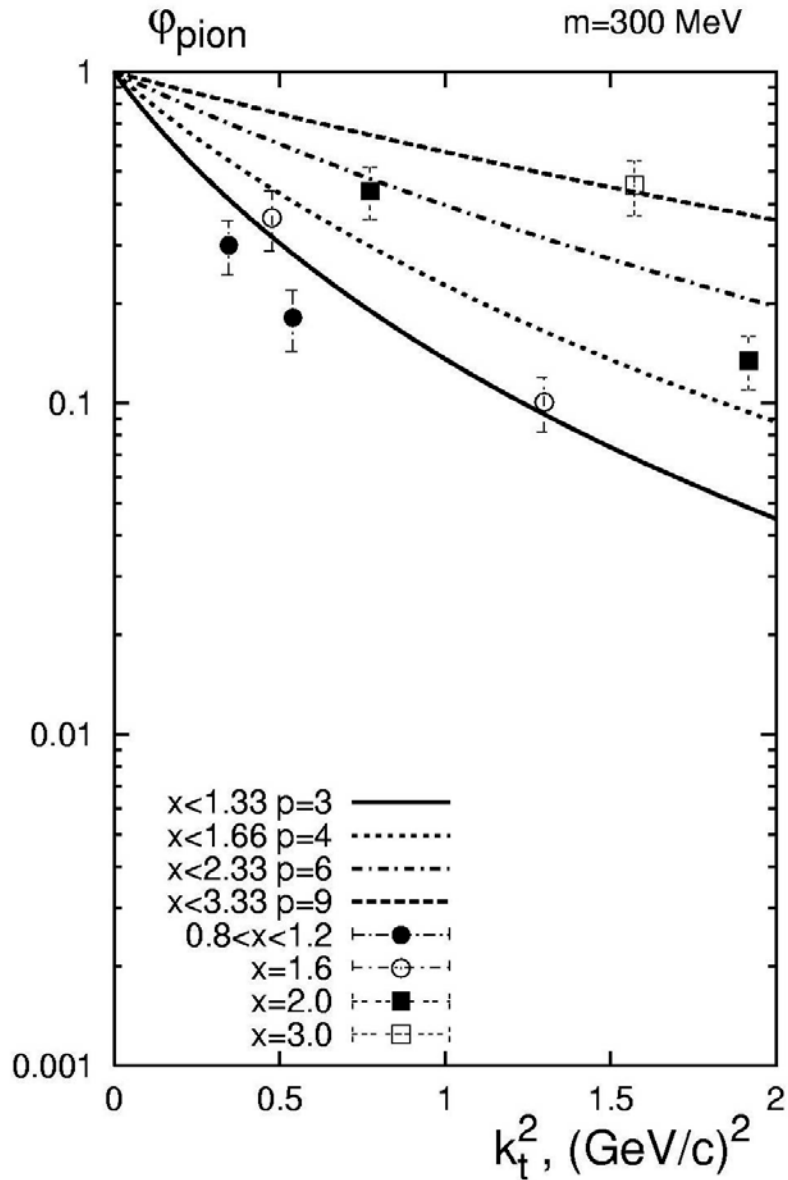

V.Vechernin,
AIP Conference Proceedings
1701 (2016) 060020.

S.V. Boyarinov et al., *Sov.J.Nucl.Phys.* **46**, 871 (1987)
S.V. Boyarinov et al., *Physics of Atomic Nuclei* **57**, 1379 (1994)
S.V. Boyarinov et al., *Sov.J.Nucl.Phys.* **55**, 917 (1992)

Application of this old approach for higher pT

For AA interaction: *V. Vechernin, S. Belokurova, S. Yurchenko, Dense Cold Quark-Gluon Matter Clusters and Their Studies at the NICA Collider, Symmetry 16 (2024) 79.*

For dd interaction: *V.V. Vechernin, S.V. Yurchenko, Cumulative production at central rapidities and large transverse momenta in the quark model of flucton fragmentation. Moscow University Physics Bulletin, 2024 (in press).*

dd collisions

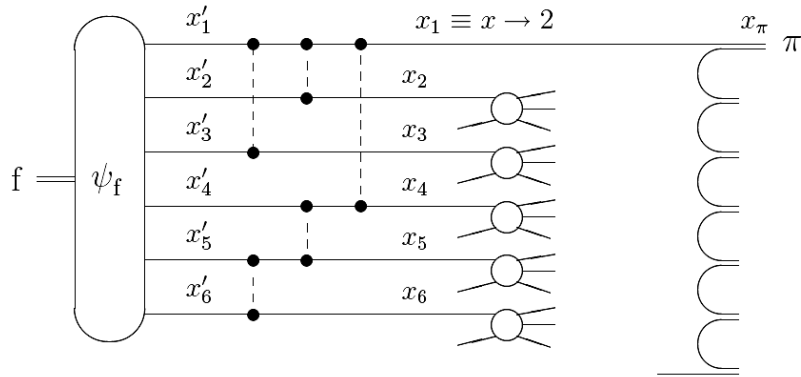

$$f_\pi(x, k_\perp) \equiv \frac{k_0 d^3 \sigma_\pi}{d^3 \mathbf{k}} = C_\pi (2-x)^9 \Phi_5 \left(\frac{k_\perp}{m_q} \right) / \Phi_5(0)$$

(1)

$$\Phi_p(t) = 2\pi \int_0^\infty dz z J_0(tz) [z K_1(z)]^p$$

$$x \equiv 2x_+$$

$$x_+ \equiv \frac{k_+}{k_+^{max}},$$

$$k_+ \equiv \frac{k_0 + k_z}{\sqrt{2}}.$$

$$x_+ = 1$$

- exact kinematic
boundary for dd reaction

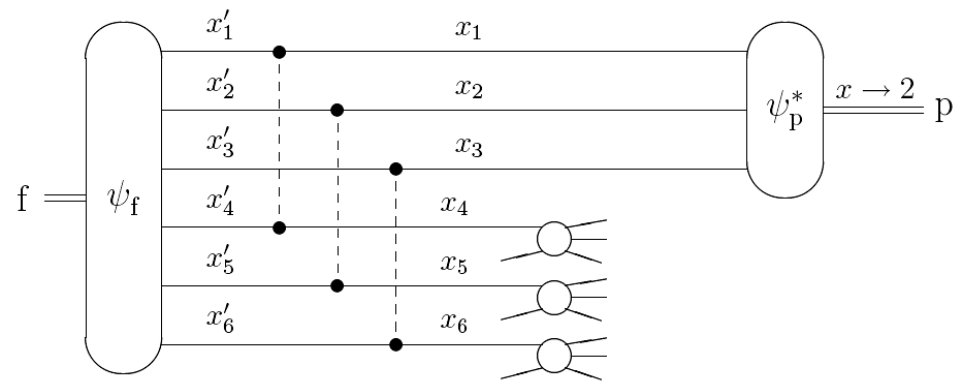

$$f_p(x, k_\perp) \equiv \frac{k_0 d^3 \sigma_p}{d^3 \mathbf{k}} = C_p (2-x)^5 \Phi_1^3 \left(\frac{k_\perp}{3m_q} \right) / \Phi_1^3(0)$$

(2)

$$\Phi_1(t) = \frac{4\pi}{(t^2 + 1)^2}$$

$x = \frac{k_+}{p_+}$ - light cone variable

$x_F = \frac{k_z}{k_z^{max}}$ - Feynman variable

$M_f^{min} = X m_N$ - cumulative number

$x \approx x_F \approx X$ at $s \rightarrow \infty$

$$\frac{m_N^2}{E^{*2}} = \frac{4m_N^2}{s}$$

Cumulative region in dd collision with different variables

$p \gg m_N$

$$\frac{k_{\perp}}{p} = \frac{\sqrt{f_1 f_2}}{(f_1 + f_2)/2} \sqrt{\left(f_1 - \frac{k_z}{p}\right) \left(f_2 + \frac{k_z}{p}\right)}$$

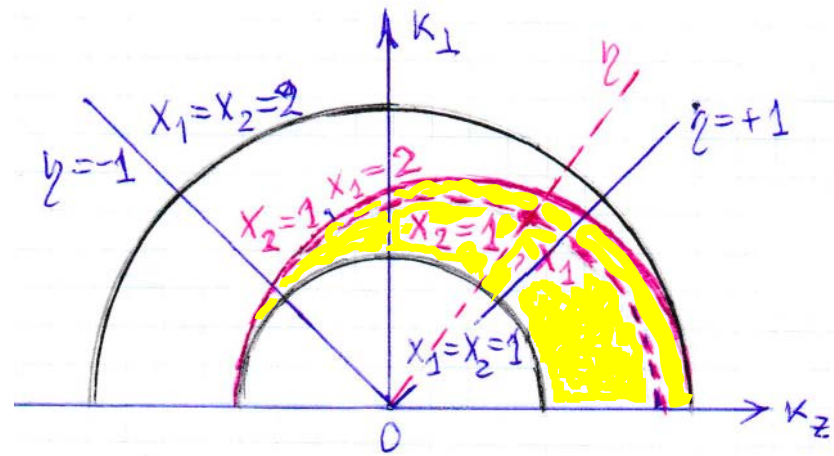
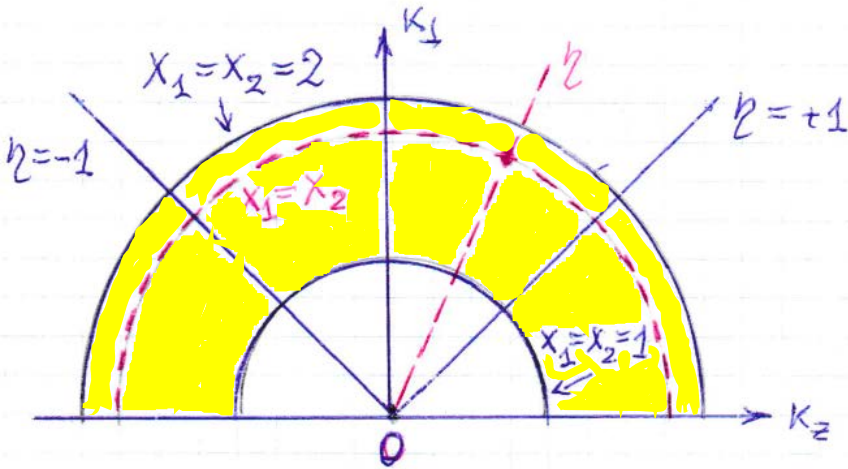

$f + N$
 $X = X_1$
 $X_2 = 1$

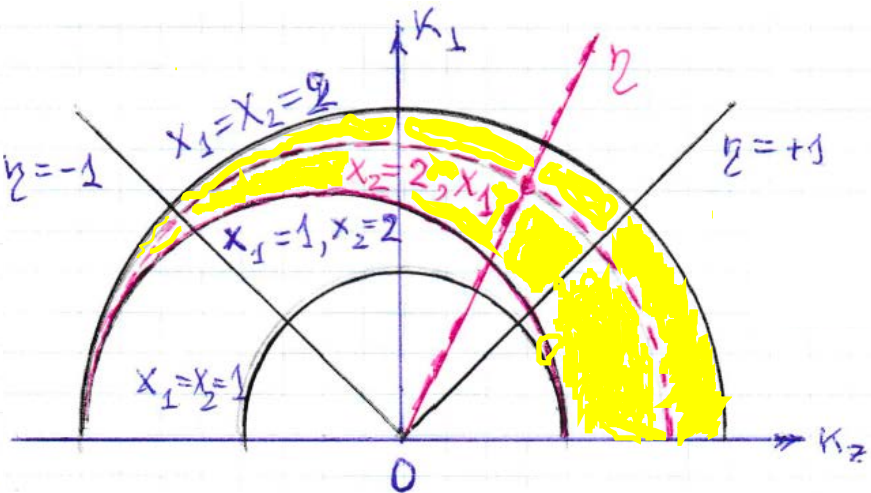
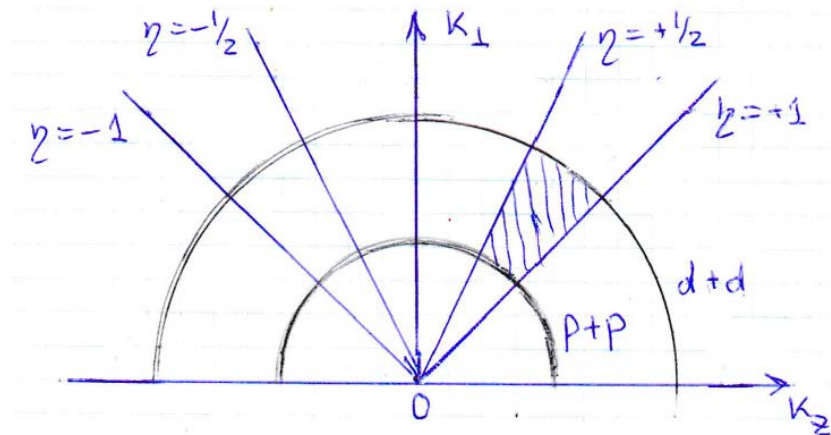

$f + 2N$
 $X = X_1$
 $X_2 = 2$

Inclusive cross sections for the production of pions and protons in dd-collisions, integrated over rapidity intervals $0.5 < |y| < 1$

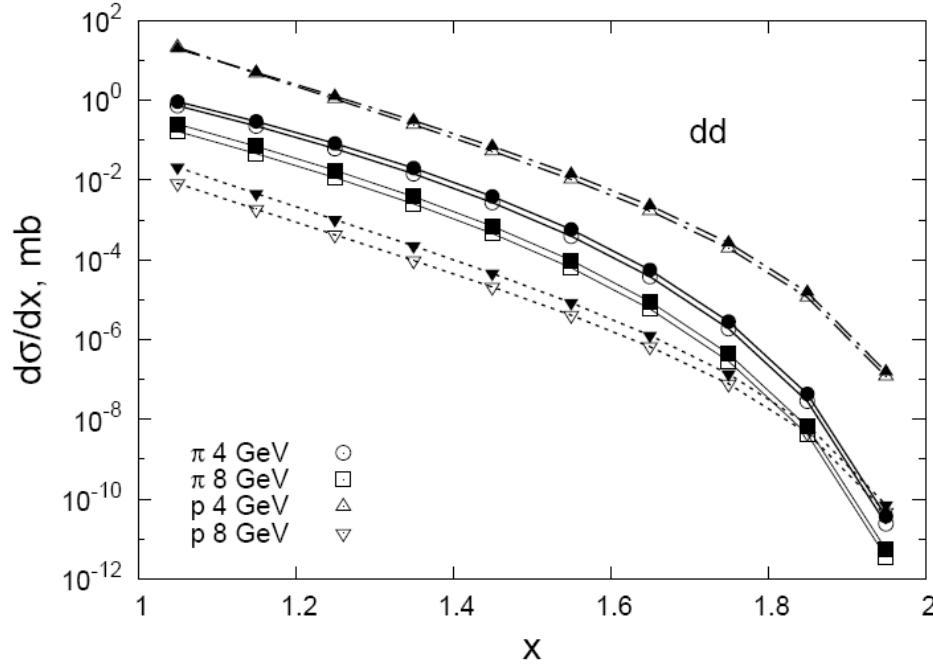

Figure 2. Inclusive cross sections for the production of pions (\circ , \square) and protons (Δ , ∇) in dd collisions, integrated over rapidity intervals $0.5 < |y| < 1$ and available for study with NICA SPD, respectively, for two initial energies $\sqrt{s_{NN}} = 4$ and 8 GeV, as a function of the light-cone cumulative variable $x = 2x_+$ (open symbols) and the cumulative number $x = x_M$ (solid symbols). Model calculations by (9) using (1) and (2). (Curves serve to guide the eye.)

$$\frac{d\sigma}{dx} = \frac{\langle n \rangle_{\text{dd}}^{\Delta x}}{\Delta x} \sigma_{\text{dd}}^{\text{tot}} = \frac{2\pi}{\Delta x} \int_{0.5}^1 dy \int_{k_{\perp}^x(y)}^{k_{\perp}^{x+\Delta x}(y)} dk_{\perp} k_{\perp} \times$$

$$\times f(x(y, k_{\perp}), k_{\perp}), \quad (9)$$

Vechernin V.V., Yurchenko S.V. Cumulative production at central rapidities and large transverse momenta in the quark model of flucton fragmentation (in press).

$$f + 2N$$

$$x_1 = x = x_M$$

$$x_2 = 2$$

Flucton-flucton interaction

Cumulative production at $|t| \sim s$

Quark counting rules for *elastic and quasi elastic reactions with nuclei*

Matveev V.A., Muradyan R.M., Tavkhelidze A.N. Lett. Nuovo Cimento 7 (1973) 719
Brodsky S., Farrar G. Phys.Rev.Lett. 31 (1973) 1153; Phys.Rev. D11 (1975) 1309
Brodsky S., Chertok B.T., Phys.Rev. D14 (1976) 3003; Phys.Rev.Lett. 37 (1976) 269

$s \rightarrow \infty, t/s$ fixed

$$(d\sigma/dt)_{\pi p \rightarrow \pi p} \sim s^{-8}, (d\sigma/dt)_{pp \rightarrow pp} \sim s^{-10}, (d\sigma/dt)_{\gamma p \rightarrow \pi p} \sim s^{-7}, (d\sigma/dt)_{\gamma p \rightarrow \gamma p} \sim s^{-6}$$

$$\sim s^{-n} \quad A+B \rightarrow C+D \quad n=n_A+n_B+n_C+n_D-2 \quad n_p=3 \quad n_\pi=2 \quad n_\gamma=1$$

$$\frac{d\sigma}{dt}(A+B \rightarrow C+D) \rightarrow \frac{1}{t^{N-2}} f(t/s) \quad N=n_A+n_B+n_C+n_D$$

Yu.L. Dokshitzer, QCD Phenomenology, Lectures at the CERN–Dubna School, Pylos, August 2002

the deuteron break-up by a photon, $\gamma + D \rightarrow p + n$

$$\frac{d\sigma}{dt} = \frac{f(\Theta)}{s^{K-2}}; \quad \frac{t}{s} = \text{const}, \quad K-2=1+6+3+3-2=11$$

For light nuclei:

Yu.N. Uzikov, Indication of Asymptotic Scaling in the Reactions $dd \rightarrow p^3\text{H}$, $dd \rightarrow n^3\text{He}$ and $pd \rightarrow pd$, JETP Letters 81 (2005) 303.

$$\sim s^{-22} (6+6+3+9-2=22) \quad \text{and} \quad \sim s^{-16} (3+6+3+6-2=16)$$

The same is valid for formfactors:

Brodsky S., Chertok B.T., *Phys.Rev. D14 (1976) 3003*

$$F_n(q^2) \sim \left(\frac{1}{q^2}\right)^{n-1}$$

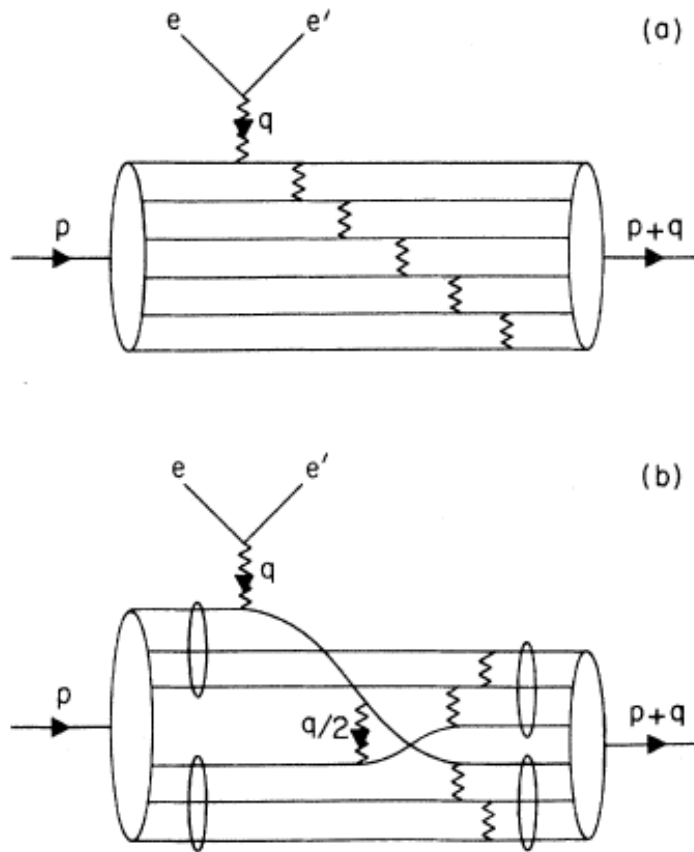

FIG. 2. Two possible quark-constituent views of e - D elastic scattering are (a) the democratic chain (cascade) model and (b) the quark-interchange model.

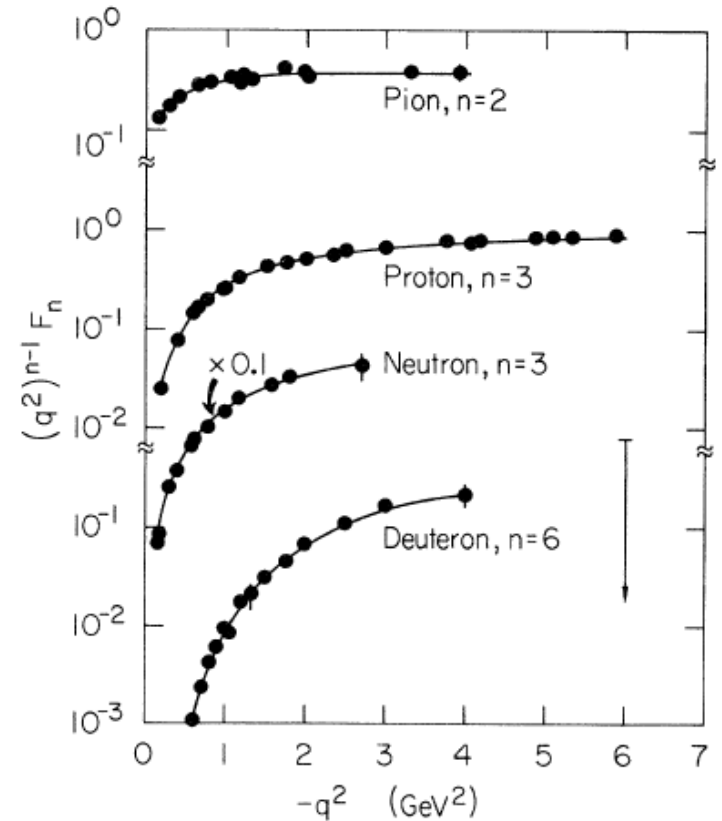

FIG. 1. Elastic electromagnetic form factors of hadrons for large spacelike q^2 in terms of the dimensional-scaling quark model. The curves simply connect the data points. (The neutron data have been multiplied by 0.1.)

Some details of formfactor calculations (compare to our slide 9)

Brodsky S., Farrar G. Phys.Rev.Lett. 31 (1973) 1153; Phys.Rev. D11 (1975) 1309

Brodsky S., Chertok B.T., Phys.Rev. D14 (1976) 3003; Phys.Rev.Lett. 37 (1976) 269

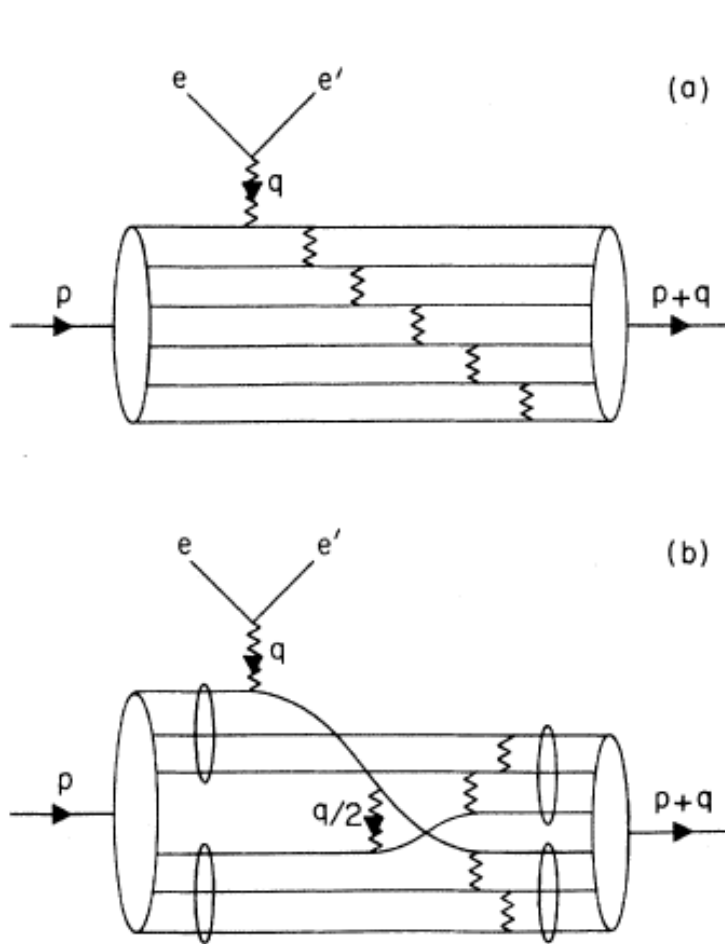

FIG. 2. Two possible quark-constituent views of e - D elastic scattering are (a) the democratic chain (cascade) model and (b) the quark-interchange model.

$$\psi_n(0) \equiv \int \prod_{j=1}^{n-1} d^3 \vec{k}_j \psi(\vec{k}_j)$$

Hence, e interacts with d , when d is in the flucton configuration.

$$F_n(\vec{q}^2) \sim \left[\frac{2m}{\vec{q}^2} V(\vec{q}^2) \right]^{n-1} \psi_n^2(0)$$

In the case of quantum electrodynamics, and in fact any renormalizable theory, we have effectively (modulo powers of $\log q^2$ from finite orders in perturbation theory)

$$V(q^2) \sim \frac{e^2}{q^2} \left[1 + O\left(\frac{q^2}{m^2}\right) \right],$$

i.e., $V(q^2)$ becomes constant in the relativistic domain and

for large q^2 the gluon propagator is always compensated by its couplings to the quark currents

$$F_n(q^2) \sim \left(\frac{1}{q^2} \right)^{n-1}$$

Quark counting rules for *inclusive cross sections at* $|t| \sim s$

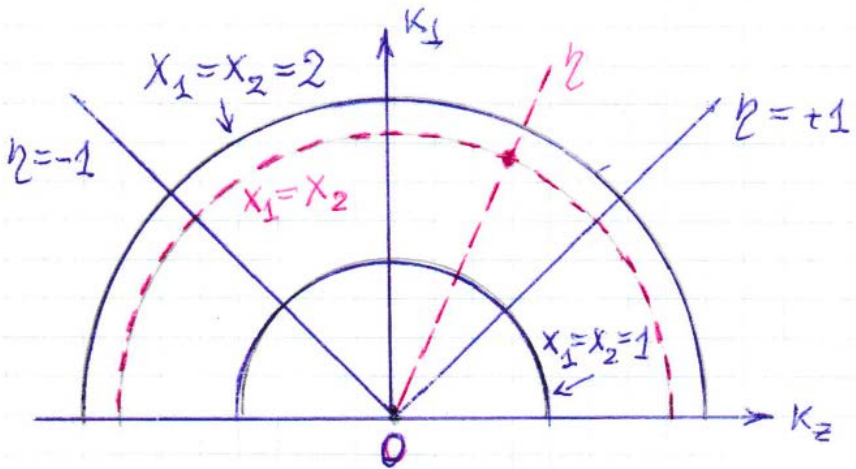

$$\Gamma_1(k'_{+i}, k'_{\perp i}) \rightarrow \Psi(k'_{+i}, k'_{\perp i})$$

$$\Gamma_2(k'_{-i}, k'_{\perp i}) \rightarrow \Psi(k'_{-i}, k'_{\perp i})$$

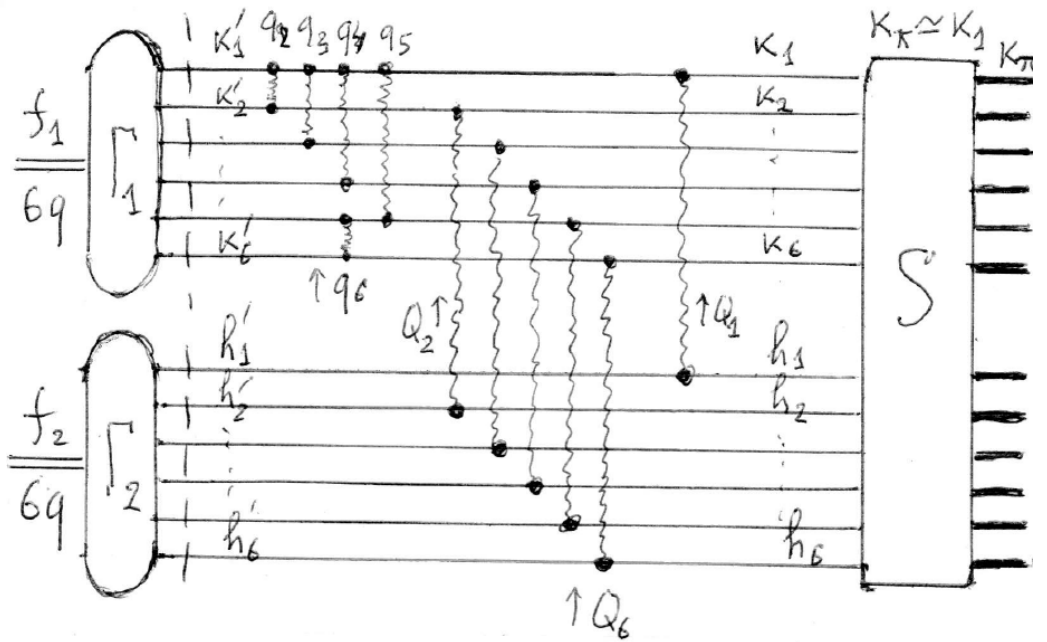

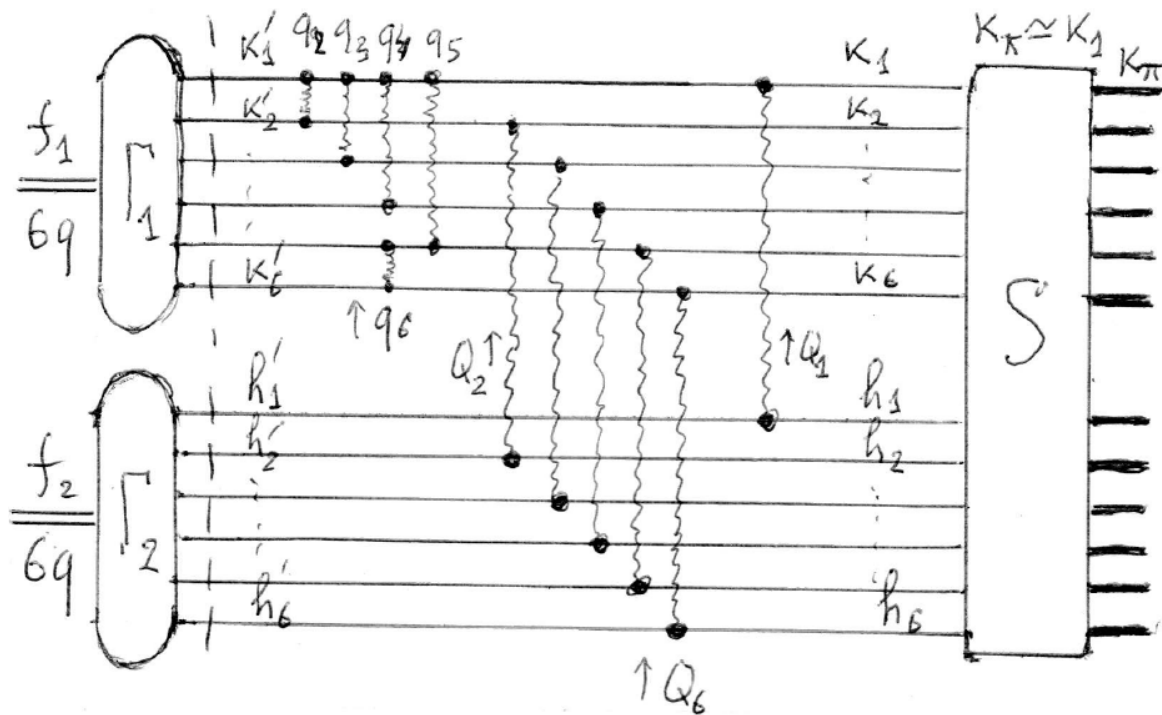

$$f(\mathbf{k}) \equiv \frac{k_0 d^3 \sigma}{d^3 \mathbf{k}} = f(x, \eta) = C s^{-m} (f - x)^k F(\eta)$$

$x = x_1 = x_2$ - cumulative number
 $\eta = -\ln \operatorname{tg} \frac{\theta^*}{2}$ - pseudorapidity

Incorporating diquarks

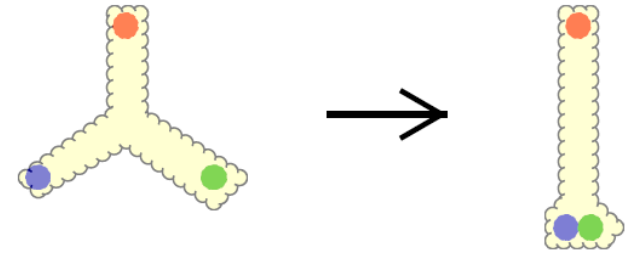

Yu.L. Dokshitzer, QCD Phenomenology,
Lectures at the CERN–Dubna School, Pylos, August 2002

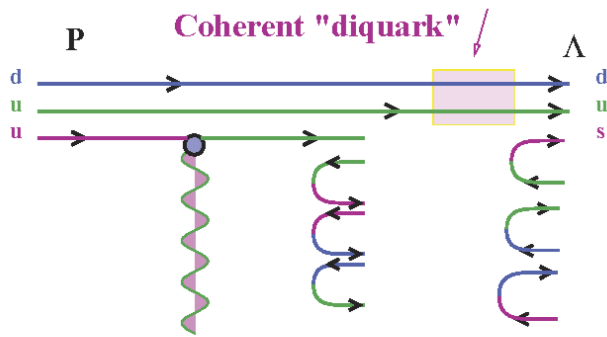
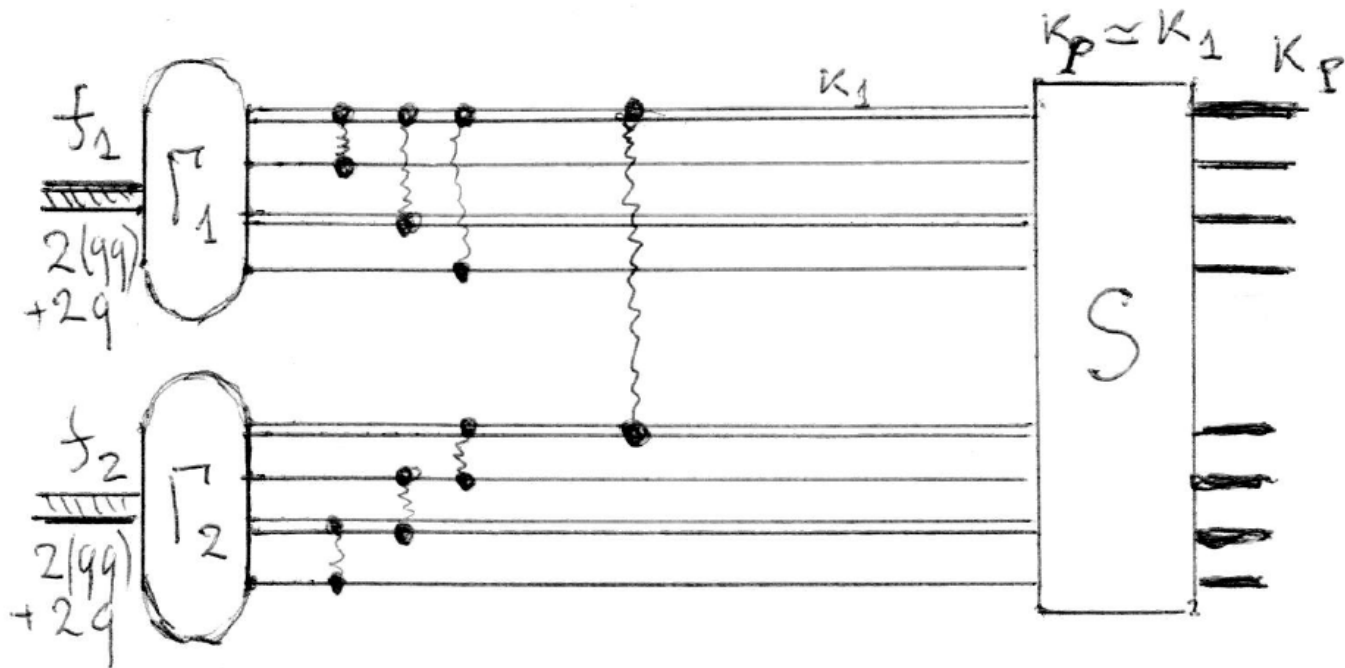

Fig. 4a: Gluon exchange produces a leading baryon.

V.T. Kim, Diquarks and Dynamics of Large P(T) Baryon Production,
Mod.Phys.Lett.A 3 (1988) 909.

p/Λ - ratio explanation, using that the diquark distribution
function is harder: $(1-x)^1$ vs $(1-x)^3$ for quarks $[(1-x)^{2p-1}]$.

M.A. Braun, V.V. Vechernin, Nuclear Structure Functions and
Particle Production in the Cumulative Region in the Parton Model,
Nucl.Phys. B427 (1994) 614



Possible mechanism for the production of cumulative protons by fragmentation of a diquark into a proton (along with the mechanism of coherent quark coalescence described above).

Conclusions

- The study of **multiquark fluctons in dd collisions at SPD** has a number of advantages (see slide 2).
- The **inclusive cross sections** for particle production in the new cumulative region of large transverse momenta at mid-rapidities **will decrease with both the initial energy s and the cumulative number $x=x_1=x_2$.**
- To evaluate this behaviour and find **asymptotes at $s \gg m$ and $(2-x) \ll 1$** we need to generalize the **quark counting rules**, known now only for
 - 1) the **inclusive cross sections** in the fragmentation region ($|t| \ll s$) and
 - 2) the **elastic and quasielastic** cross sections in the high p_T region ($|t| \sim s$),
to the case of **inclusive cross sections** in the high p_T region ($|t| \sim s$).

The authors acknowledge Saint-Petersburg State University for a research projects ID: 95413904 and 118437783.

Backup slides

Contribution of pion rescattering to cumulative proton production from deuteron (long distance contribution !)

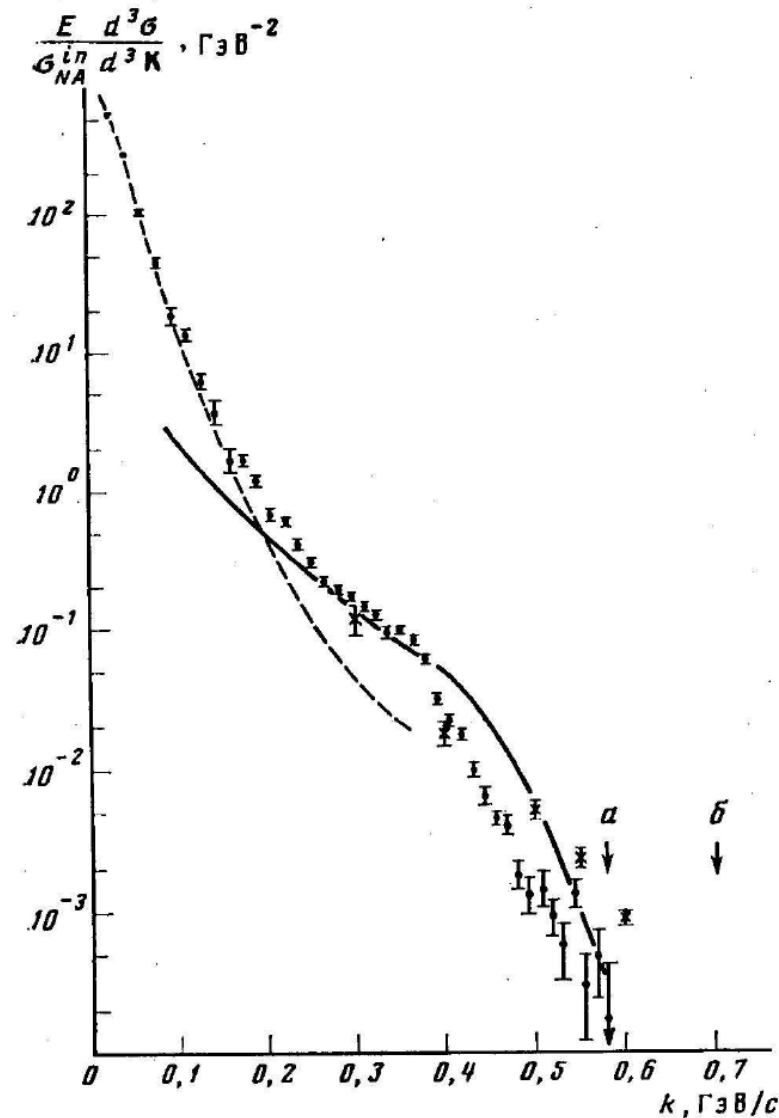
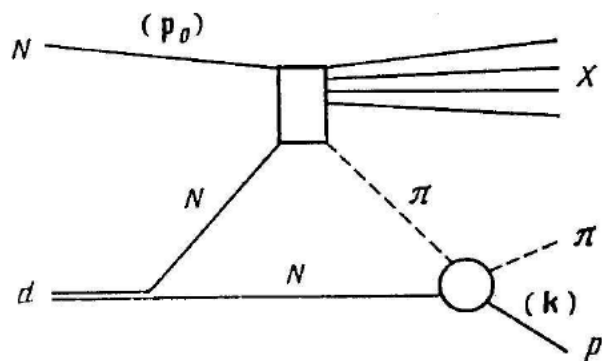

Prediction:

Braun M.A., Vechernin V.V., *Yad.Fiz.* 28 (1978) 1466.

Experiment:

Ableev V.G. et al., *Nucl.Phys.A* 393 (1983) 491.

Preprint JINR EI-82-377, Dubna, 1982.

Confirmation:

Braun M.A., Vechernin V.V., *Yad.Fiz.* 40 (1984) 1588.

Braun M.A., Vechernin V.V., *Yad.Fiz.* 43 (1986) 1579.

The shoulder in the spectrum is due to the contribution of the Δ -resonance to elastic πN scattering amplitude

Fixation of normalization constants

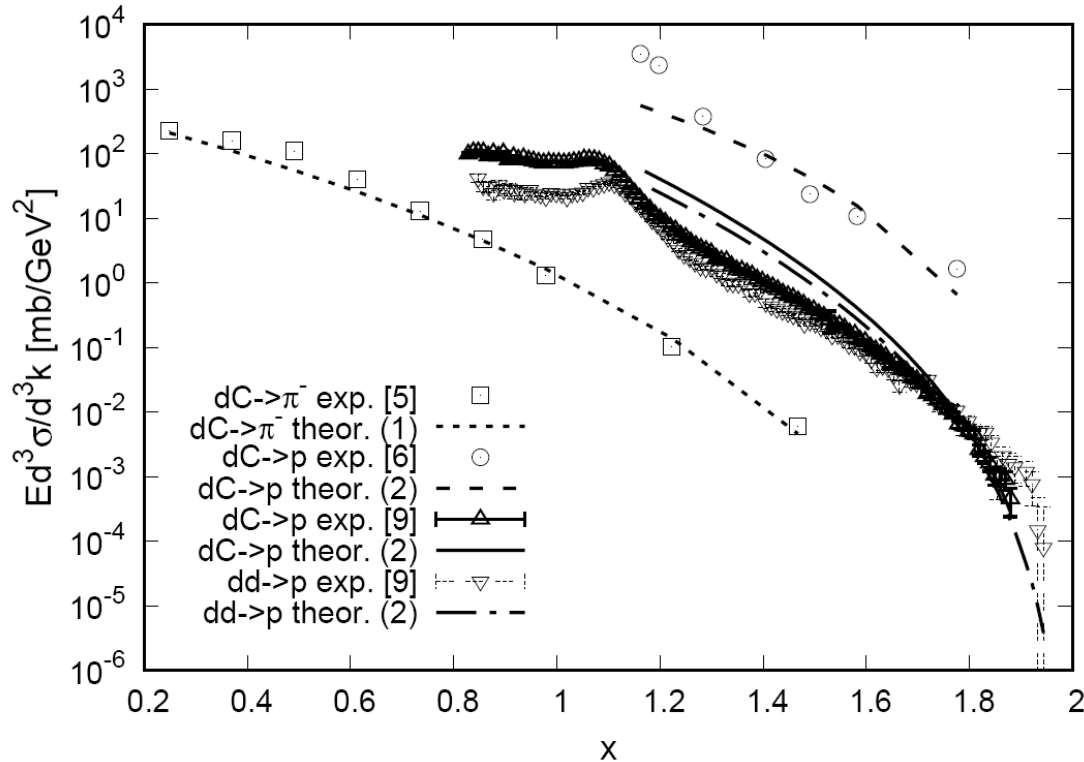

$$C_{\pi}^{dC} = 1.4 \text{ mb/GeV}^2 ,$$

$$C_p^{dC} = 1500 \text{ mb/GeV}^2$$

[9] L.S. Azhgirei et al., *Sov. J. Nucl. Phys.* **46**, 661 (1987)

$$p_{lab}^d = 9.0 \text{ GeV} \quad (\sqrt{s_{NN}} = 3.2 \text{ GeV}) \quad 0.139 \text{ rad} = 8^\circ$$

$$d+C \Rightarrow p+X, \quad d+d \Rightarrow p+X$$

[5] J. Papp et al., *Phys. Rev. Lett.* **34**, 601 (1975)

[6] J. Papp, Ph. D. thesis, Univ. of California, Berkeley, Report No. LBL-3633, 1975

[I.A. Schmidt and R. Blankenbecler, *Phys. Rev. D* **15**, 3321-1326 (1977)]

$$E_{lab}^{kin} = 2.1 \text{ GeV} \quad \sqrt{s_{NN}} = 2.7 \text{ GeV} \quad 2.5^\circ$$

$$d+C \Rightarrow \pi^- + X, \quad d+C \Rightarrow p+X$$

A-dependence of the deuteron fragmentation

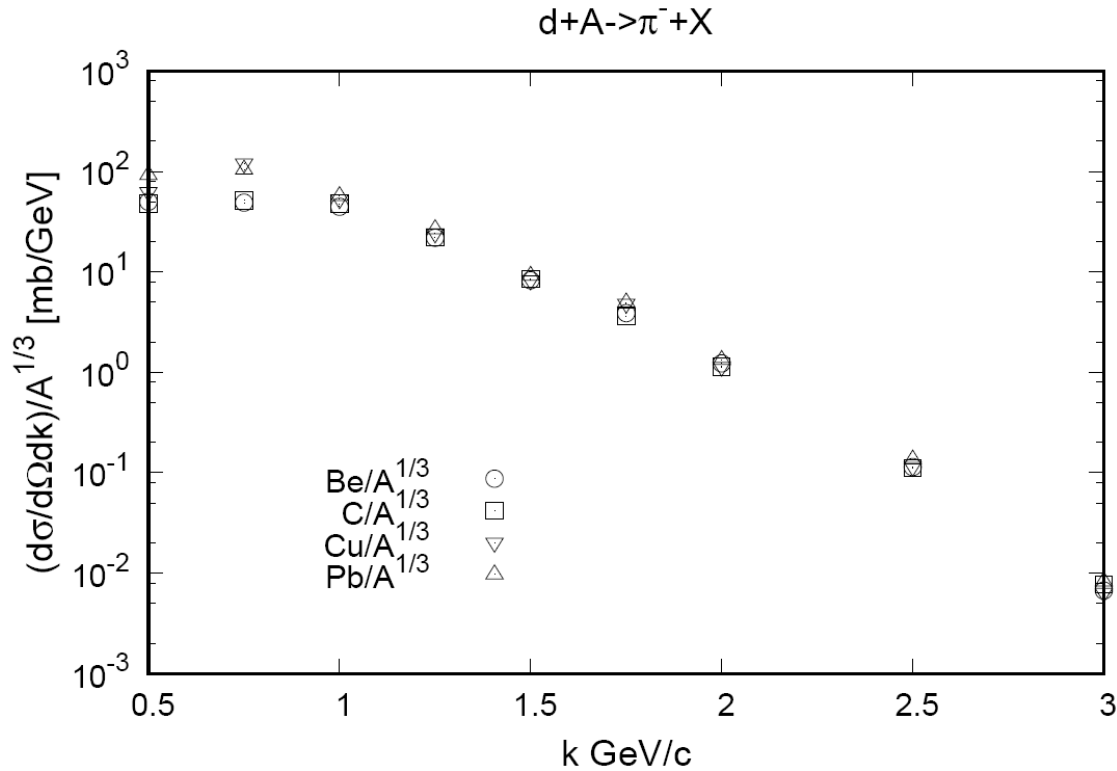

$$[5] \quad \sim A^{1/3} \quad \Rightarrow$$

$$C_\pi = C_\pi^{dd} = 0.77 \text{ mb/GeV}^2$$

$$C_p = C_p^{dd} = 825 \text{ mb/GeV}^2$$

Transverse momentum spectra of cumulative pions

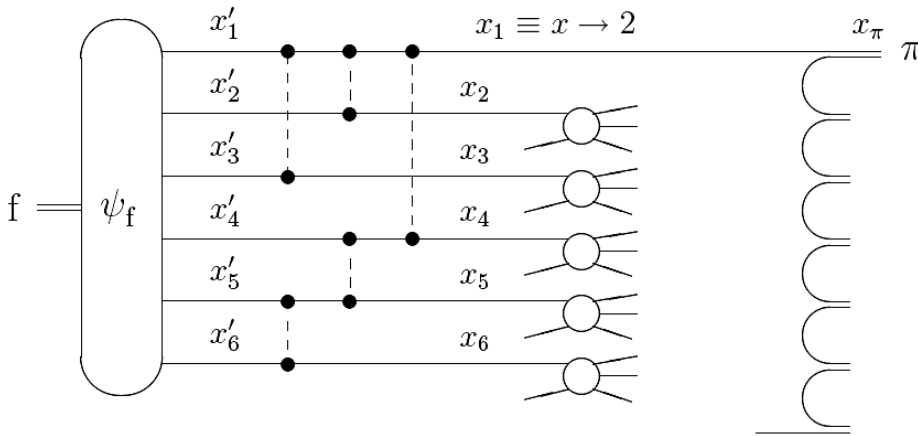

- the cumulative pion production

k_{\perp} – dependence:

*M.A. Braun, V.V. Vechernin,
Phys.Atom.Nucl. **63**, 1831 (2000)*

$$\sigma_{pion}(x, k_{\perp}; p) = C(p) (x_{frag} - x)^{2p-1} f_p\left(\frac{k_{\perp}}{m}\right)$$

$$x < x_{frag}(p) = 1/3 + p/3$$

p – the number of “donors”, stopped quarks

m – the constituent quark mass

$$f_p(t) = \frac{1}{\pi^p} \int \prod_{i=1}^p \frac{d^2 t_i}{(t_i^2 + 1)^2} (2\pi)^2 \delta^{(2)}\left(\sum_{i=1}^p t_i + t\right)$$

$$t = k_{\perp}/m, \quad t_i = k_{i\perp}/m$$

$$f_p(t) = 2\pi \int_0^{\infty} dz z J_0(tz) [z K_1(z)]^p$$

$$\langle |K_{\perp}| \rangle = pm \int_0^{\infty} dz K_0(z) (z K_1(z))^{p-1}$$

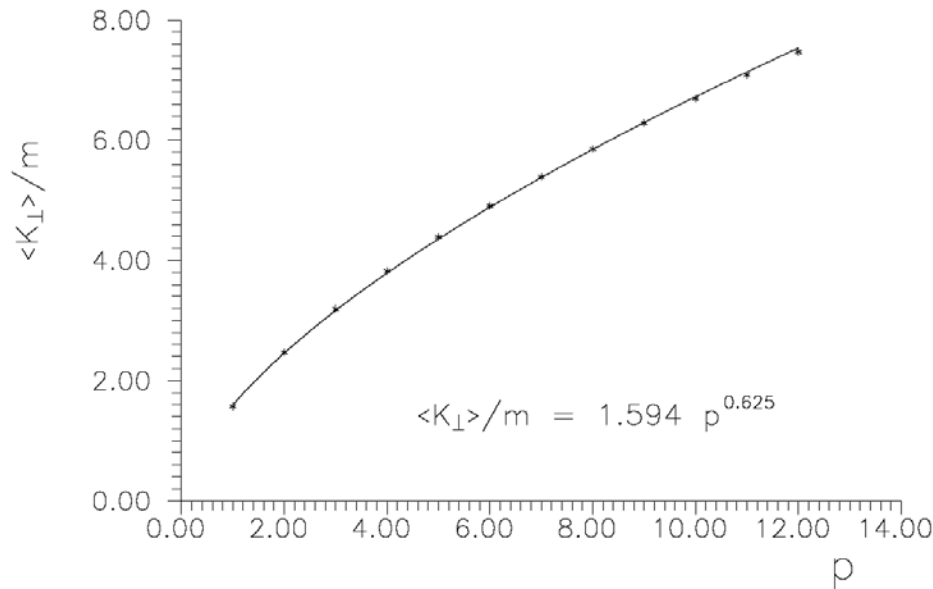

Comparison of Interaction Rates in AuAu (BiBi) collisions at MPD and in dd collisions at SPD

$$\text{MPD: } L_{\text{AuAu}} = 10^{27} \text{ cm}^{-2} \text{ c}^{-1}$$

$$\sigma_{\text{AuAu}}^{\text{tot}} \cong 7000 \text{ mb}$$

Present and future HI experiments

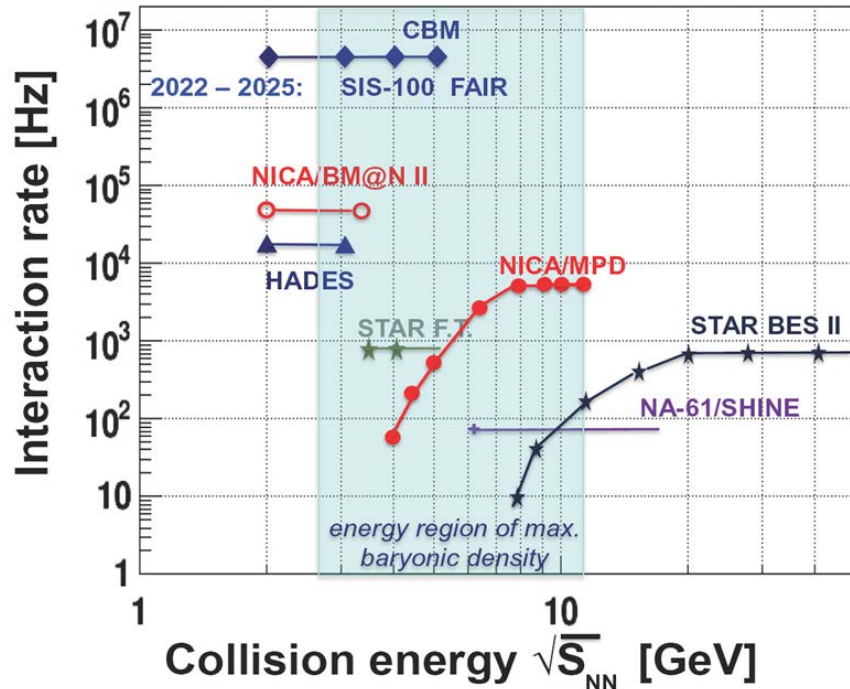

$$I_{\text{AuAu}} = L_{\text{AuAu}} \sigma_{\text{AuAu}}^{\text{tot}} = 7 \text{ KHz}$$

V. Kekelidze, A. Kovalenko, R. Lednicky, V. Matveev, I. Meshkov, A. Sorin, G. Trubnikov, Feasibility study of heavy-ion collision physics at NICA, Nuclear Physics A 967 (2017) 884–887.

$$\sigma_{\text{dd}}^{\text{tot}} \cong 120 \text{ mb}$$

$$\text{SPD: } L_{\text{dd}} = 10^{30} \text{ cm}^{-2} \text{ c}^{-1}$$

$$I_{\text{dd}} = L_{\text{dd}} \sigma_{\text{dd}}^{\text{tot}} = 120 \text{ KHz}$$

V.M. Abazov, et al. [The SPD collaboration], "Conceptual design of the Spin Physics Detector ArXiv:2102.00442v3 [hep-ex], 2022.